



**ICON10 / ICON1
Control Panel
Advanced Features Manual**

0999953_A

**Software Versions:
ICON10 v 1.01
Smart Relay Board (SRB) v 1.01**

Table of Contents

About This Manual	6	RJ11	34
Ancillary Equipment Warranty	6	SPARE.....	34
Overview.....	7	Protocol and Baud Rate	35
ICON Mobile Application.....	7	VRI-iS Protocol.....	35
Main Screen.....	8	Position Encoder Protocol	35
Setup.....	9	Valley GPS Protocol	36
Main Screen.....	11	Valley GPS.....	36
Field.....	11	Valley GPS and Device Discovery	36
Pivot Name	11	PLC End Guns 3 & 4	39
Pivot Road	11	VGPS Water Pressure	39
Part Circle Pivot.....	11	VRI-Zone	39
Field (Continued).....	12	Tire Pressure	39
Rotate Pivot	12	Valley GPS Device List	40
Status	13	PLC ID	40
Controls.....	14	PLC Protocol	41
Constants.....	15	GPS V2.....	41
System	15	PLC End Gun 3 / 4	42
Minimum Application.....	15	Water Pressure.....	43
Hours Per Revolution.....	15	Tire Pressure	43
% Cycle Time.....	16	VRI-Zone	43
Contractor Enable Delay.....	16	Valmont Communication Protocol (VCP)	44
Low Voltage	17	Flow Control.....	44
Voltage Calibration.....	17	High Speed (High Speed Key Wait).....	44
Cruise Control.....	18	Key Wait.....	44
% Change of Speed (max)	18	Transmission Test Button	45
Field Size.....	18	RTU ID.....	45
Resolution.....	18	Display	46
Pump.....	19	System.....	47
Auto Restart Via: (Auto Restart)	19	Controls.....	49
Pump Type.....	20	Status Bar.....	49
Low Pressure.....	20	Control Buttons.....	50
High Pressure.....	20	Volts / Pressure.....	51
Sensor Setup.....	22	Diagnostics	52
Sensor Calibration	23	I/O Test	53
Pressure Delays Setup.....	24	Outputs	53
Position.....	25	Reviewing Outputs	53
Position Encoder.....	25	Inputs.....	54
Position Encoder Direction Offset.....	26	Reviewing Inputs.....	54
Calculating Direction Offset	27	Service Mode	55
GPS Position	29	Service Mode.....	55
GPS Setup	29	Enable/Disable Service Mode	55
Position Loss Setup.....	31	Remote Lockout.....	56
Watering Timer	32	Enable/Disable Remote Lockout	56
Watering Timer Status	32	Data	57
Overwater Shutdown (%).....	33	Flow/Hours	57
Push Enter to retain the value.....	33	Total Flow.....	57
Overwater Timer Instructions.....	33	Flow Rate.....	57
Underwater Error (%).....	33	Flow Multiplier.....	57
Underwater Timer Instructions.....	33	Setting the Flow Multiplier	57
Comm Port.....	34	Low Flow Limit	58
DB9	34	Total Hours.....	58
DB9-Y.....	34	Wet Hours.....	58

Table of Contents

System (Continued)

Setting Total Hours or Wet Hours	58
Pulse	59
Edit Counter Readings	59
SRB A/D	60
Reviewing A/D	60
History	61
Battery Backup Option	62
Enable Battery Backup	62
Test Battery	62
Set Keep Awake Time	62
Utilities	63
End Guns	65
End Guns 3 and 4	65
End Gun Display	65
End Gun Sequence Pairs	66
Configure End Guns	67
Auto Reverse Auto Stop (AR/AS)	68
Enable/Disable AR/AS	69
Forward/Reverse Position Setup	70
Enable Forward/Reverse Position	70
Weather	71
Current Weather	71
Wind Speed	71
Wind Shutdown	71
Temperature	72
Temperature Shutdown	72
Temperature Shutdown	72
Rain Measurement	73
Rain Shutdown	73
Enable Rain Shutdown	73
Rain History	74
Weather Constants	75
Temperature Coefficient	75
Temperature Offset	75
Rain Window (days)	75
Rain Coefficient (inches/pulse)	75
Notice	76
Event Notifications	77
Enable/Disable Event Notifications	77
Base ID	79
Callout Tries	79
Comm Port	79
Transmission Test	79
Radio Setup	80
Number of Radio Hops	80
Radio Hop IDs	80
Enabling/Disabling Radio Hops	80
Tire Pressure Monitor System (TPMS)	81

TPMS Data	81
TPMS Constants	82
TPMS Shutdown	82
Warning Pressure	82
Shutdown Pressure	82
TPMS Sensor	83
TPMS Diagnostics	84
TPMS Water	85
TPMS Water Constants	85
TPMS Water Data	85
TPMS Water Diagnostics	85
Programs	87
Daily Ops	89
Enable/Disable Daily Ops	89
Setting Daily Operations	89
Daily Operations Mode	90
Load Management Mode	90
START\$ Program	91
Using START\$	92
Configure Times	93
Setting Times	93
Configure Days	93
Setting Days	93
Restart Activated (for Load Mgmt Mode)	93
Step Programs	95
Step Programs Functions	95
Available Commands	95
Stored Program	95
Programming Conditions	96
Analog	96
Analog Conditions	96
Pulse Rate	96
Pulse Count	96
Wind	96
Rain	96
Temperature	97
End Gun	97
Aux 1 and 2	97
Remote Start	97
Pressure Switch	97
Spare PTG	97
Safety Sense	97
Cable Theft	97
Run Program Command	98
Sample Step Program Design Form	99
Write a New Program	100
Review or Edit a Step Program	101
Deleting a Step Program	102
Step Programs	103
Sample Step Program Design Form	103
Example 1. Program by Date, Time, and Position .	104

Table of Contents

Programs (Continued)

Example 2. Program by Day and Time.....	108	START\$ Interval Enable/Disable	151
Example 3. Program by Date/Time and Position with SIS On	111	Stop-In-Slot (SIS).....	151
Example 4. Program by Pressure.....	114	Start Time (HH:MM).....	152
Example 5. Program with Percent-of-Percent Timer or Percent-of-Depth.....	116	Restart in (Days).....	152
Example 6. Program with Enable/Disable End Guns.....	117	Program START\$.....	152
Example 7. Program with Enable Cruise Control .. 118		SIS Bypass.....	153
Example 8. Program for a Logging Event.....	119	Example 1. START\$ Interval - Interval in Days	154
Example 9. Using Run Program Command	120	Setup Cycle Interval	154
Scheduled Irrigation Cycles	125	Write CYCLE\$ Program.....	155
Example 10. Time Delay with Run Program Com- mand	125	Program Step 1.....	155
START\$ Program Example	132	Program Step 2.....	156
Delayed Start - Recommended.....	132	Finish Programming.....	156
Immediate Start - Not Recommended.....	132	VRI-Speed Control.....	157
Editing.....	133	VRI-S Screen	157
Edit Step 1	133	VRI-S Enable/Disable	157
STOP\$ Program Example.....	134	Rx #	157
Immediate Stop	134	Main Screen Status	158
Editing.....	134	Irrigation Prescription	158
Edit Step 1	134	Prescription Upload Methods	158
CYCLE\$ Program Example - Repeating Cycles	135	Position Values.....	158
Using CYCLE\$ Program	135	Configure Prescriptions.....	159
Start Programming	135	Edit Sectors	159
Program Step 1.....	135	Review Rx.....	160
Program Step 2.....	136	VRI-Zone Control.....	161
Finish Programming.....	136	VRI-Z Screen.....	161
Execute Cycles By Time.....	137	VRI-Z Enable/Disable	161
Finish Programming.....	137	Main Screen Status	161
Sector Programs	139	Irrigation Prescription	162
Sector Program Functions.....	139	Prescription Upload Methods	162
Program Run Status Key.....	139	Position Values.....	162
Available Commands.....	140	View Prescription.....	163
Using Run.....	140	Edit Sectors	164
Sample Sector Program Design Form	141	VRI-Z Constants.....	165
Write a New Program.....	142	Re-synchronize Valve Duty Cycle.....	165
Reviewing or Editing Sector Programs.....	143	Valve Resync Pressure (PSI)	165
Deleting a Stored Program.....	143	Sprinkler Banks	165
Stopping a Running Program	143	Minimum Cycle Time	166
Designing Sector Programs	145	VRI-Z Diagnostics	167
Example Sector Program and Design Form....	145	System Shutdown.....	167
Using the Depth and Percent Commands.....	146	Sprinkler Bank Off	167
Programming a Sector.....	146	Valve Resync.....	167
Programming the Next Sector	148	VRI-Z Overview	168
Using the Percent-of-Percent or Percent-of-Depth Command.....	149	VRI Tower Box	168
Programming the First Sector.....	149	Water Filter	168
Cycles	151	Sprinkler Valve	168
START\$ Interval	151	Stand Pipe Option	169
		VRI-individual Sprinkler (VRI-iS) Control	170
		VRI-iS Screen.....	170
		VRI-iS Enable/Disable	170
		Main Screen Status	171
		Irrigation Prescription	171
		Prescription Upload Methods	171
		Position Values.....	171
		View Prescription.....	172
		Edit Managed Zones	173

Table of Contents

Programs (Continued)

VRI-iS Constants.....	174
Re-synchronize Valve Duty Cycle.....	174
Valve Resync Pressure (PSI)	174
Minimum Cycle Time	174
Maximum Cycle Time	174
Number of Sprinklers.....	175
Last Sprinkler Position	175
Sprinkler Spacing	175
Speed Optimization Enable/Disable	175
VRI-iS Diagnostics	176
Configure Network.....	176
Resync Valves	177
Sequence Valves	177
Test Valve.....	178
Valve Errors	179
Valve Comm Errors.....	180

Appendix: Programming Design Forms..... 181

Design Forms.....	181
Step Programming Design Form.....	182
Sector Programming Design Form.....	183

About This Manual

Information contained in this manual applies to all Valley ICON10 and ICON1 Control Panels with the following software versions:

- ICON10 v 1.01 Smart Relay Board (SRB) v 1.01

Sections related to safety, pivot hardware, maintenance, towing, troubleshooting, and winterization are covered in the appropriate Valley Pivot Owner's Manuals.

You, as the owner/operator, should familiarize yourself with the capabilities of the system in order to obtain optimum system performance. Remember that the sprinkler will perform according to your knowledge of the equipment, soil and water relationships, and equipment application concepts.

Specifications, descriptions and illustrative material contained herein were as accurate as known at the time this publication was approved for printing.

Valmont Industries Inc. reserves the right to change specification or design without incurring obligation. Specifications are applicable to machines sold in the United States and may vary outside the United States.

Additional information is contained within the ICON10 / ICON1 Control Panel Owner's Manual, Part Number 0999955 (English).

Ancillary Equipment Warranty

The owner is responsible for warranty registration of all ancillary equipment such as engines, pumps and generators with its respective manufacturer.

ICON Mobile Application

The ICON mobile application is required for ICON1 and optional for ICON10 prior to using any mobile devices: tablets, smart phones, or laptops, the Edge-of-Field WiFi™ must be configured. A WiFi capable device is required and the ICON mobile app will need to be downloaded from the app store compatible with your device. See Figure 7-1 which represents a typical Main Screen as viewed on a tablet. The mobile app provides a flyout menu of all connected devices on your WiFi Network, and allows control of the machine and configuration of the control panel remotely. **The Controls and Status fields can be customized and may look different than what is shown in Figure 7-1.**



Figure 7-1



Overview

Main Screen

The Main Screen is where you begin operating your irrigation machine, and where you learn its current status. Controls are located on the left side of the screen, the machine's current status is located on the right side of the screen. See Figure 8-1, which represents a typical main screen. The following pages describe the elements that can appear on the Main Screen. **The Controls and Status fields can be customized and may look different than what is shown in Figure 8-1.**



Figure 8-1

Controls - Item 1		Up to six control buttons can appear on the left side of the screen for programming and operating the machine.
Status - Item 2		Up to eight statuses can appear on the right side of the screen. Below the statuses is a graphic image depicting the machine's current position.
Start Forward - Item 3		Push to start the machine and move in the forward (clockwise) direction.
Start Reverse - Item 4		Push to start the machine and move in the reverse (counter-clockwise) direction.
Stop - Item 5		Push to halt machine movement, shut pump off, and close water valve. (if wired to do so) The machine has a time delay that prevents it from restarting when you press a start button within five seconds after stopping the machine with water ON.

Setup Menu

Push **Menu** and **Setup** to display the Setup menu. The user can change settings or view information from the Setup menu at any time. The following flowchart is provided to help you navigate the Setup menu. Refer to Figure 9-1.

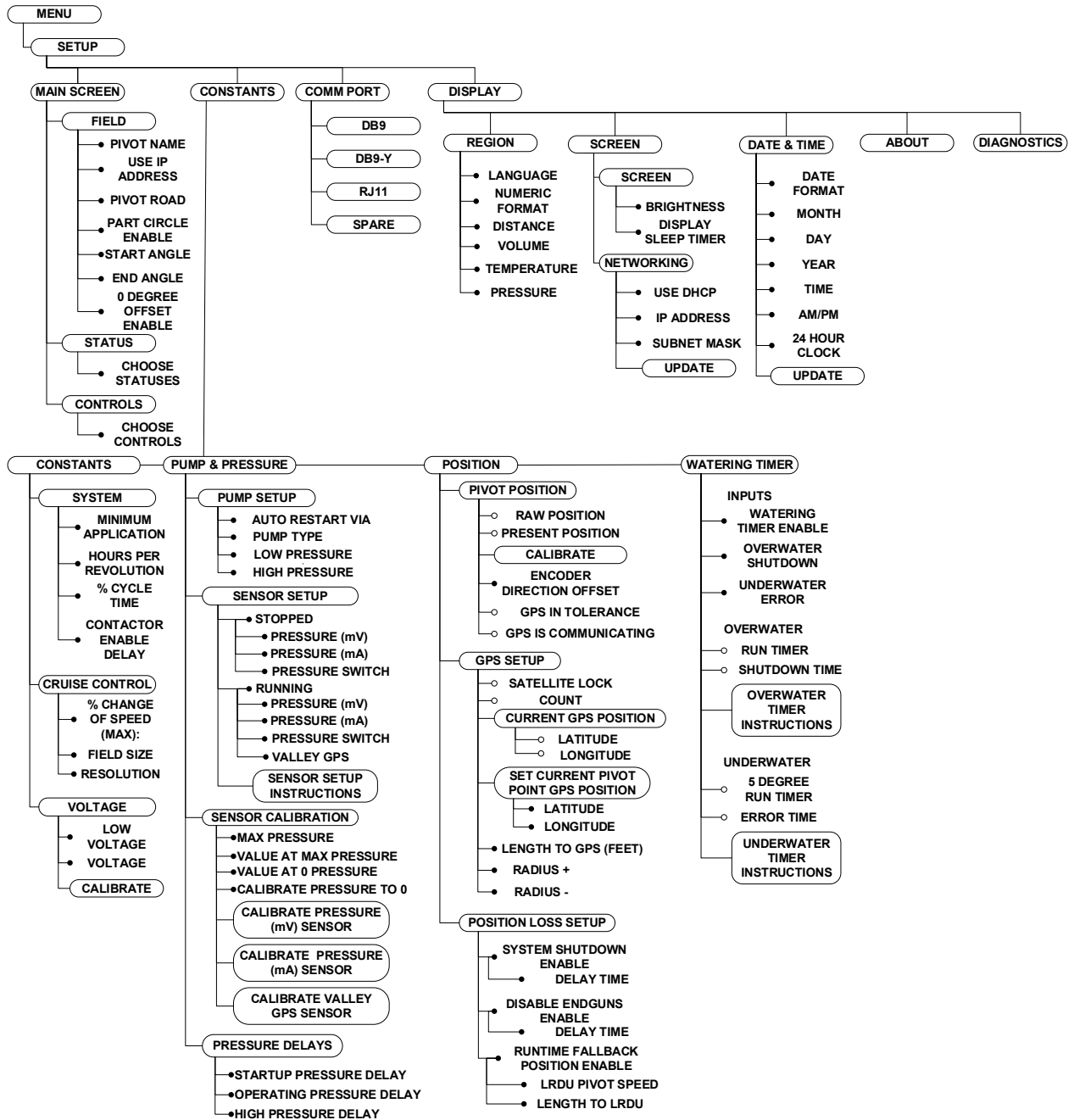

Figure 9-1

Main Screen

Push **Menu**, **Setup**, and **Main Screen** to display the Main Screen menu. Refer to Figure 11-1.

The Main Screen menu is used to configure the Field display setting. It is also used to establish which functions will be monitored, and which functions will be controlled on the Main screen.

Field

Pivot Name

To change the pivot name or use the IP Address follow these steps:

1. Push **Menu**, **Setup**, **Main Screen**, and **Field** to display the Field screen. Refer to Figure 11-2.
2. To change the **Pivot Name** select the pivot name field and enter a new name using the keyboard.
3. To **Use IP Address** of the ICON module as the pivot name select the Use IP Address checkbox to enable it.

Pivot Road

To enable the pivot road and set the position follow these steps:

1. Push **Menu**, **Setup**, **Main Screen**, and **Field** to display the Field screen. Refer to Figure 11-1.
2. Check the **Pivot Road** checkbox to enable.
3. Select the **Pivot Road** field.
4. Enter the Pivot Road position from 0.0° to 359.9°, using the numeric keypad.
5. Push **Enter** to retain the value.

Part Circle Pivot

If this is a full circle pivot, no changes need to be made. However, if this is a part circle pivot, enable Part Circle and set the start and end angles.

1. To enable part circle pivot and set the start and end angles, Push **Menu**, **Setup**, **Main Screen**, and **Field** to display the Field screen. Refer to Figure 11-2.
2. Check the **Part Circle** checkbox to enable.
3. Select the **Start Angle** field.
4. Enter the start angle from 0.0° to 359.9° using the keypad.
5. Push **Enter** to retain the value.
6. Select the **End Angle** field.
7. Enter the end angle from 0.0° to 359.9° using the numeric keypad.
8. Push **Enter** to retain the value.

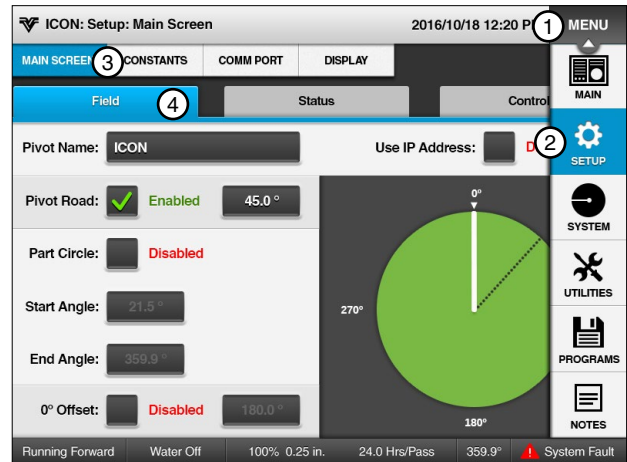

Figure 11-1 1. Menu 2. Setup 3. Main Screen 4. Field

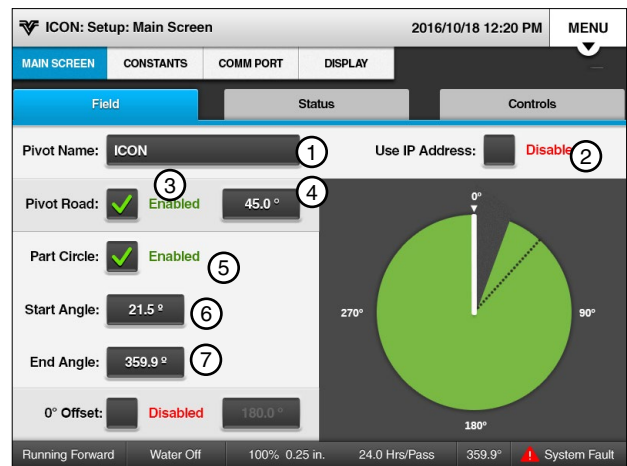

Figure 11-2 1. Pivot Name 2. Use IP Address 3. Pivot Road 4. Pivot Road Position 5. Part Circle Checkbox 6. Start Angle 7. End Angle

NOTE

- When **Part Circle** is enabled, you are creating a graphical representation of the pivot field. The control panel does NOT prevent the machine from running outside the designated zone. It also does NOT stop the machine at the start angle or end angle.
- An empty **Part Circle** checkbox indicates a full circle field.

Setup / Main Screen

Field (Continued)

Rotate Pivot

To set the rotate pivot follow these steps:

1. Push **Menu**, **Setup**, **Main Screen**, and **Field** to display the Field screen. Refer to Figure 12-1.
2. Check the **0° Offset** checkbox to enable the rotate pivot.
3. Enter the Pivot Rotate from 0.0° to 359.9° , using the numeric keypad.
4. Push **Enter** to retain the value.

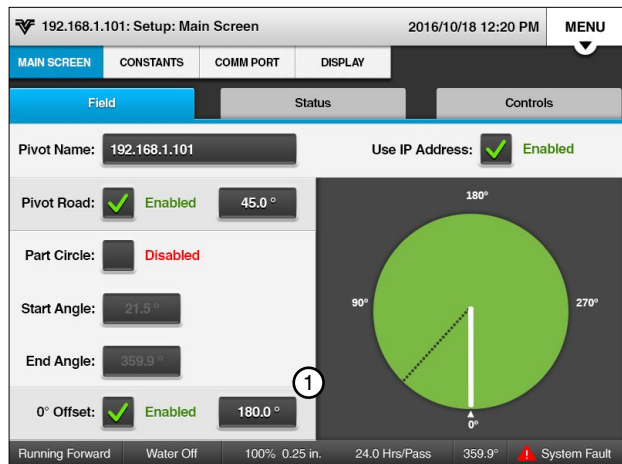

Figure 12-1 1. 0 Degree Offset

Status

Choose up to six different functions to monitor on the Main screen. The status of each selection will be displayed in the top, center of the Main screen.

1. To set the Main Screen status lines, push **Menu**, **Setup**, **Main Screen**, and **Status** to display the status screen. Refer to Figure 13-1.
2. Select a **Status Line** drop-down menu.
3. Choose the status to be displayed in the drop-down menu.
4. Repeat step 2 and 3 for the other status line drop-down menus.

The status of the following functions can be displayed.

- Voltage
- Pressure (mV)
- AR/AS
- Depth and %
- Errors
- Adjusted %
- Hrs/Pass
- Wind
- Rain
- Flow Meter
- Pressure Switch
- Wet Hours
- Empty
- Temperature
- Pressure (mA)
- Total Hours
- End Pressure

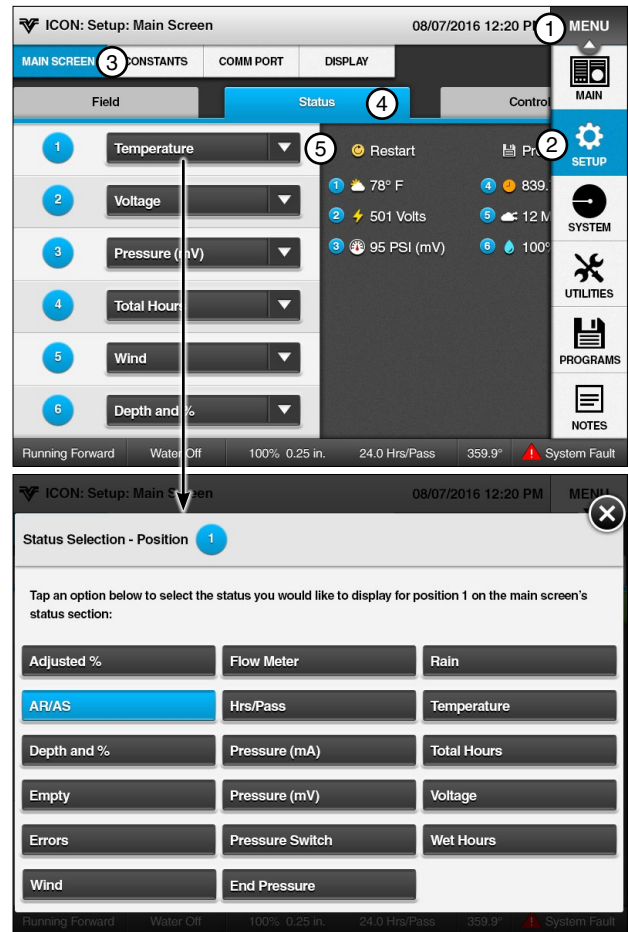

Figure 13-1 1. Menu 4. Status
2. Setup 5. Status Drop-Down
3. Main Screen

Setup / Main Screen

Controls

Choose up to six different controls that you want to appear on the Main Screen. The Controls Drop-Down Menu number relates to the location of the control on the Main Screen.

1. To set the Main screen controls, Push **Menu**, **Setup**, **Main Screen**, and **Controls** to display the Controls screen. Refer to Figure 14-1.
2. Select a **Control** drop-down menu.
3. Choose the control to be displayed on the Main screen.
4. Repeat step 2 and 3 for any other control drop-down menus.

Control of the following functions can be selected.

- Water
- Cruise (Hours)
- Depth and %
- Stop in Slot
- AR/AS
- Auto Restart
- AUX1
- AUX2
- Empty
- End Gun 1
- End Gun 2
- End Gun 3 (optional)
- End Gun 4 (optional)

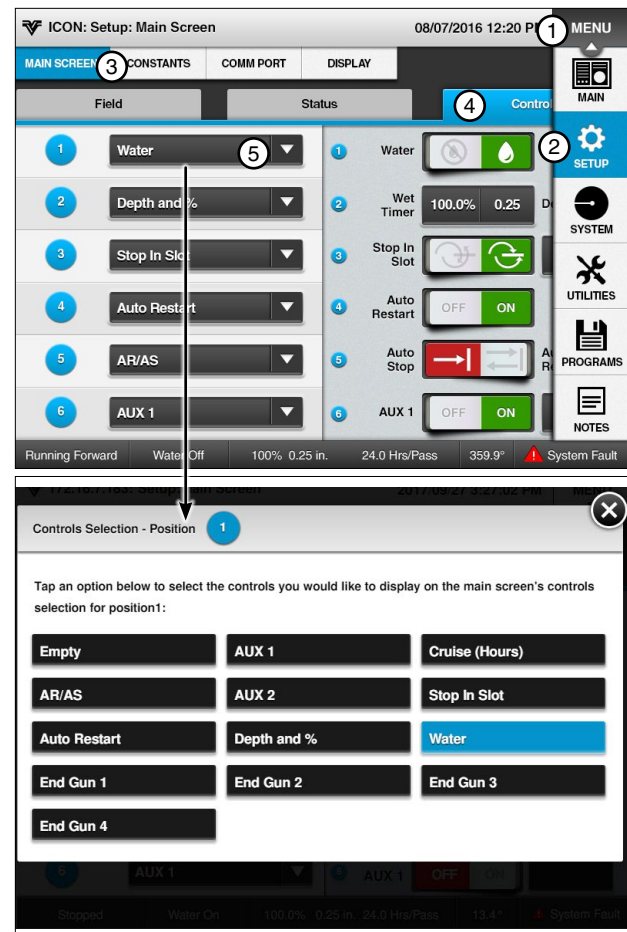

Figure 14-1 1. Menu 2. Setup 3. Main Screen 4. Controls 5. Controls Drop-Down

Constants

Push **Menu**, **Setup**, and **Constants** to display the Constants.

Push **Menu**, **Setup**, **Constants**, and **Constants** to display the System/Cruise Control/Voltage screen. Refer to Figure 15-1.

System

Minimum Application

Minimum Application is used to set the depth of water applied at a percentage timer setting of 100 percent. Refer to Figure 15-1.

The minimum application value is specific to the machine, and is used to calculate water applications at different machine speeds. Refer to your machine's VChart Timer Report for this value, or contact your Valley dealer. The minimum application factory default setting is 0.250 in (6.35 mm).

Setting Minimum Application

To set the Minimum Application follow these steps:

1. Push the **Menu**, **Setup**, **Constants**, and **Constants** to display the System screen. Refer to Figure 15-1.
2. Select the **Minimum Application** field.
3. Using the numeric keypad, enter the minimum application from 0.001 to 1.000 in, or 0.001 to 25.40 millimeters, from the VChart Timer Report for your machine.
4. Push **Enter** to retain the value.

Hours Per Revolution

The **Hours Per Revolution** is used to set the number of hours required, at a percent timer setting of 100%, for the machine to make one complete revolution. Refer to Figure 15-1.

The Hours Per Revolution value is used to calculate hours per revolution for different percent timer settings, and is displayed on the Main screen. The value is specific to the machine. Refer to your machine's VChart Timer Report for this value, or contact your Valley dealer. The default setting is 24.0 hours.

Setting Hours Per Revolution

To set the hours per revolution follow these steps:

1. Select the **Hours Per Revolution** field.
2. Using the numeric keypad, enter the hours per revolution from the VChart Timer Report at 100%.
3. Push **Enter** to retain the value.

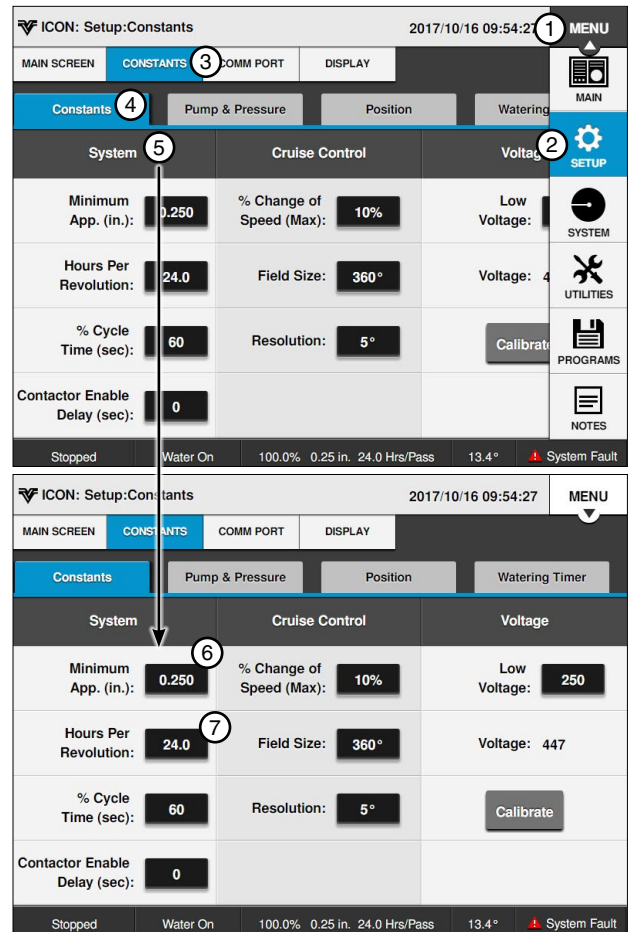

Figure 15-1 1. Menu 5. System/Cruise Control/
2. Setup Voltage
3. Constants 6. Minimum Application
4. Constants 7. Hours Per revolution

Setup / Constants

System/Voltage (Continued)

% Cycle Time

% Cycle Time is used to set the Percent Timer Cycle Time. The Percent Timer Cycle Time factory default setting is 60 seconds. When the Percent Timer Cycle Time is set at 60 seconds, and the Percent Timer is set at 50 percent, the end tower moves for 30 seconds of each minute. The Percent Timer Cycle Time can be set from 20 to 200 seconds.



CAUTION

• INCREASING THE PERCENT TIMER CYCLE TIME SETTING OVER 60 SECONDS MAY CAUSE UN-EVEN WATER DISTRIBUTION.

Setting % Cycle Time

To set the Percent Timer Cycle Time follow these steps:

1. Push the **Menu, Setup, Constants, and Constants** to display the System/Voltage screen. Refer to Figure 16-1.
2. Select the **% Cycle Time** field.
3. Using the numeric keypad, enter the Percent Timer Cycle Time in seconds.
4. Push **Enter** to retain the value.

Contractor Enable Delay

The Contractor Enable Delay sets the delay (in seconds) until the contractor can be enabled. The range can be set from 0 to 5,000 seconds. Refer to Figure 16-1.

Setting Contractor Enable Delay

To set the Contractor Enable Delay Time follow these steps:

1. Push the **Menu, Setup, Constants, and Constants** to display the System/Voltage screen. Refer to Figure 16-1.
2. Select the **Contractor Enable Delay** field.
3. Using the numeric keypad, enter the Contractor Enable Delay Time in seconds.
4. Push **Enter** to retain the value.

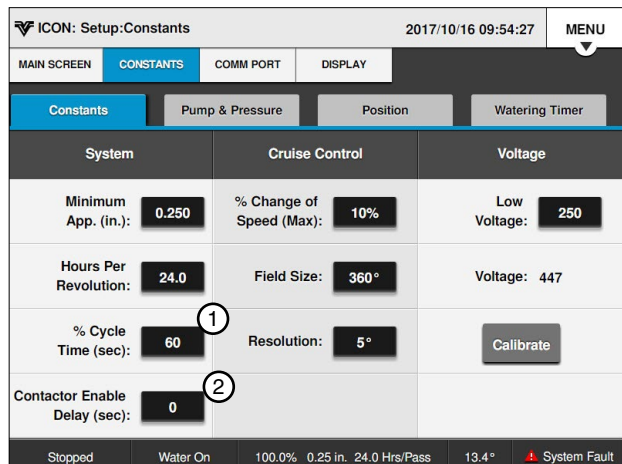

Figure 16-1 System Voltage Screen
1. % Cycle Time
2. Contractor Enable Delay

Voltage

Low Voltage

The Low Voltage constant is used to set the Low Voltage limit. The Low Voltage limit factory default setting is 440 volts for use with a supply voltage of 480 VAC @ 60Hz. Recommended Low Voltage limits for other supply voltages are shown in the Recommended Low Voltage chart. Refer to Figure 17-1.

If the control panel voltmeter senses voltage below the Low Voltage limit, a built-in timer keeps the machine running for up to 15 seconds to prevent nuisance shutdowns due to voltage fluctuations.

If the Low Voltage condition still exists after 15 seconds, the machine is shut down and the diagnostics screen will display a fault for System Power Low Fault.

Nominal Supply Voltage	Recommended Low Voltage Setting
480 VAC @ 60Hz	440 VAC
415 VAC @ 50Hz	375 VAC
400 VAC @ 50Hz	365 VAC
380 VAC @ 50Hz	355 VAC
230 VAC @ 60Hz	220 VAC
220 VAC @ 50Hz	210 VAC

Figure 17-1 Recommended Low Voltage

CAUTION

- DO NOT SET LOW VOLTAGE LOWER THAN THE RECOMMENDED LOW VOLTAGE LIMIT.
- LOW VOLTAGE WILL DAMAGE THE DRIVE MOTORS AND OTHER ELECTRICAL COMPONENTS. CORRECT THE PROBLEM BEFORE RESUMING OPERATION.

Setting Low Voltage

To set the Low Voltage limit follow these steps:

1. Push the **Menu, Setup, Constants, and System/Voltage** to display the System/Voltage screen. Refer to Figure 17-2.
2. Select the **Low Voltage** field.
3. Using the numeric keypad, enter the low voltage limit in volts.
4. Push **Enter** to retain the value.

Voltage Calibration

The Voltage Calibration button calibrates the volt meter with the actual voltage coming into the control panel so that the voltage fluctuations can be monitored correctly. Calibration recommended while the machine is running.

The incoming voltage to the control panel must be measured with a meter by a qualified electrician or service person. This value is entered as the voltage constant.

The supply voltage should never exceed the limits shown in the Maximum Supply Voltage chart. Refer to Figure 17-3.

Setting Voltage

To set the voltage follow these steps:

1. Push the **Menu, Setup, Constants, and System/Voltage** to display the System/Voltage screen. Refer to Figure 17-2.
2. Push the **Calibrate** button.
3. Using the numeric keypad, enter the actual measured voltage.
4. Push **Enter** to retain the value.

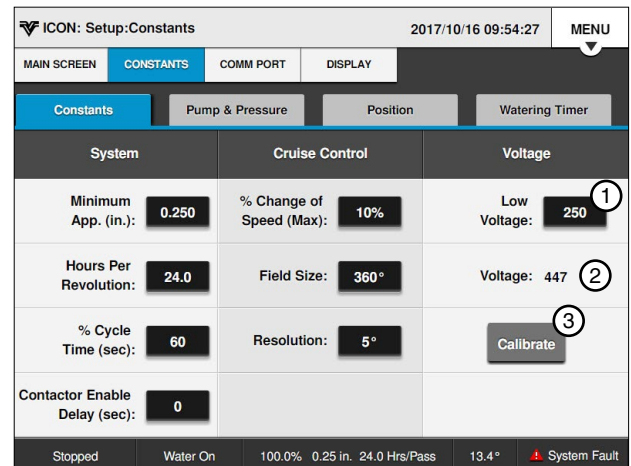

Figure 17-2 1. Low Voltage 2. Voltage 3. Calibrate

Nominal Supply Voltage	Maximum Supply Voltage
480 VAC @ 60Hz	505 VAC
415 VAC @ 50Hz	420 VAC
400 VAC @ 50Hz	420 VAC
380 VAC @ 50Hz	420 VAC
230 VAC @ 60Hz	253 VAC
220 VAC @ 50Hz	243 VAC

Figure 17-3 Maximum Supply Voltage

Setup / Constants

Cruise Control

Use Cruise Control to program the irrigation machine to automatically adjust its speed, based on completing a defined number of degrees (Resolution) in a specific amount of time. This feature can be used to more precisely manage chemigation and fertigation through the irrigation machine.

The Cruise Control settings for the **% Change Of Speed (max)**, **Field Size**, and **Resolution** constants can be viewed or changed from the Constants screen. Push **Menu**, **Setup, Constants**, and **Constants** for the Cruise Control screen. Refer to Figure 18-1.

% Change of Speed (max)

The % Change of Speed (max) is used to view and change the maximum percentage change of speed. This value is the maximum percentage of change in speed that Cruise is allowed to make. The default setting is 10%. The range is 0% to 255%. When set to 0%, Cruise is not allowed to change the speed. When set to 255%, Cruise is allowed to change 255% of the set % timer setting.

For example, if the Percent Timer is set to 20% and the Max % Change Of Speed is set to 50%, then Cruise can adjust the Percent Timer in a range from 10%-30%.

To change the % Change of Speed follow these steps:

1. Select the **% Change of Speed (max)** field.
2. Using the numeric keypad, enter a percentage from 0 to 255.
3. Push **Enter** to retain the value.

Field Size

Field Size is used to view and change the Field Size. This value is the Field Size in degrees, and assumes that the field always starts counting at 0 degrees. The default is 360 degrees. The range is 15 to 360 degrees.

To change the Field Size follow these steps:

1. Select the **Field Size** field.
2. Using the numeric keypad, enter a degree from 15 to 360.
3. Push **Enter** to retain the value.

Resolution

The Resolution value is the number of degrees that the machine must travel before Cruise recalculates. Cruise looks forward at the estimated distance remaining and, using the Hrs/Pass constant, it recalculates the speed while staying within the set limits. The default setting is 5 degrees. The valid range is 1, 5, 10, or 15 degrees.

To change the Resolution follow these steps:

1. Select the **Resolution** field.
2. Using the numeric keypad, enter a degree: 1, 5, 10 or 15 degrees.
3. Push **Enter** to retain the value.

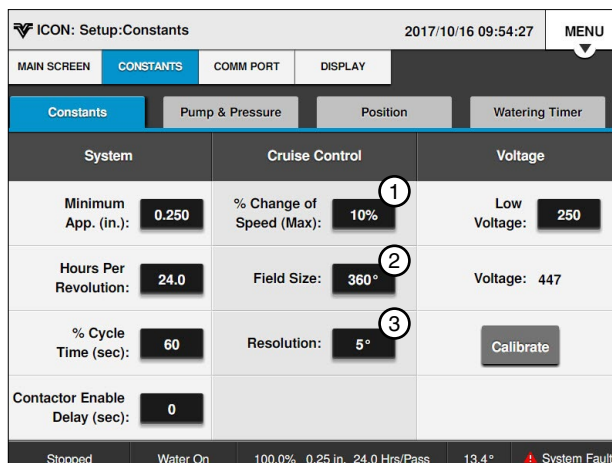

Figure 18-1 1. % Change of Speed
2. Field Size
3. Resolution

Pump

Push **Menu**, **Setup**, **Constants**, **Pump & Pressure**, and **Pump** for the Pump screen. Refer to Figure 19-1.

Auto Restart Via: (Auto Restart)

The Auto Restart option is used to restart the machine automatically. It will restart when either the pressure or the power have been returned to the machine after the machine was shut down by pressure, power, or both. The Auto Restart Via drop-down menu is used to select the shutdown input. Refer to Figure 19-1.

When Auto Restart is on and the machine is running, a Restart message is displayed on the Main screen status when the machine is running to remind the user that the machine is programmed to restart automatically.

NOTE

• **The Restart message is also shown on the Main screen when Daily Ops is on and activated.**

- If the machine is shut down by pushing the STOP button, by the stop-in-slot position, or by a programmed shutdown, Auto Restart is temporarily disabled by the control panel, and the Restart status changes to a No Restart status on the Main screen as shown in Figure 19-1.

If the operator starts the machine again by pushing the Start button, or by a programmed start, the Restart message appears on the Main screen and Auto Restart is active again.

Pressure Restart

When Auto Restart is on and a shutdown occurs because of a loss of water pressure, the machine restarts when pressure is regained and reaches the low pressure limit. Pressure restart does not use the START\$ program unless power is cycled.

Power Restart

When Auto Restart is on and a shutdown occurs because of a loss of power, the control panel runs the START\$ program when power is restored.

The START\$ program must contain all commands required to restart the machine to the desired status, including an adequate delay and the Start command. This is important when a pump restart delay is required after a momentary loss of power resulting in a shutdown.

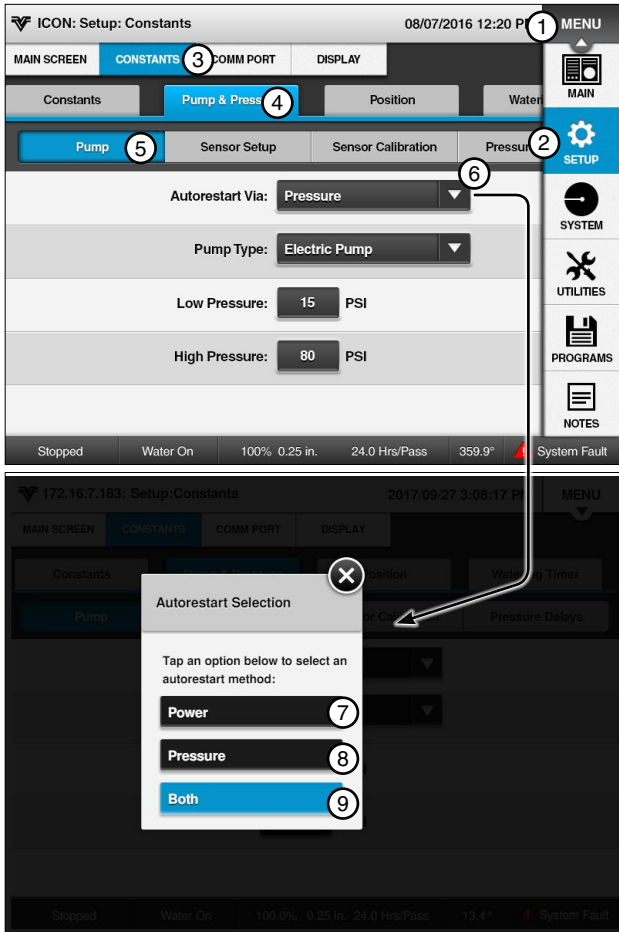

Figure 19-1 1. Menu 2. Setup 3. Constants 4. Pump 5. Pump 6. Auto Restart Via 7. Power 8. Pressure 9. Both

Setup / Constants

Pump (Continued)

Auto Restart Via

NOTE

- If **START\$** is not programmed with a start-up procedure, power restart does not operate correctly, even though Auto Restart is on.
- If a machine was shut down by pushing **STOP**, by the stop-in-slot position, or by a programmed shutdown, it does **NOT** power restart if the power is lost and comes back on, because the initial shutdown was not caused by loss of power or pressure.

Using Auto Restart

To command the Auto Restart option on or off follow these steps:

1. Push **Menu, System, Panel**, and **Controls**. Refer to Figure 20-1.
2. Push the **Auto Restart** switch to turn Auto Restart on or off.

Pump Type

The **Pump Type** field is used to select and control the type of pumping unit that is being used with the machine. The choices are Engine Pump or Electric Pump. The factory default setting is **Electric Pump**. Refer to Figure 21-1.

Electric Pump indicates an electric motor is being used to operate the pumping unit. The Pump mode engages the pump safety relay when water is turned on, and disengages the relay when water is turned off.

Engine indicates a combustion engine is being used as the power for operating the pump. The Engine mode keeps the pump safety relay engaged while the machine is running, water on or water off, and disengages the relay when the machine is stopped.

- **Engine Pump** stops the machine and disengages the engine simultaneously after a 3.0 second delay.

Low Pressure

Low Pressure is used to set the water pressure minimum that must be met before the machine runs or continues running.

If the water pressure in the machine falls below the low pressure limit, and the pressure delays have expired, the machine and water supply (if wired to do so) shut down due to a pressure fault, which is displayed on the Menu/System/Diagnostics, and System Faults screen. The low pressure limit factory default setting is 15 psi (103 kPa).

High Pressure

High Pressure is used to set the water pressure limit that shuts down the machine and records a High Pressure Fault.

If the water pressure in the machine reaches the high pressure limit, and the pressure delays have expired, the machine and water supply (if wired to do so) shut down due to a high pressure fault, which is displayed on the Diagnostics/Faults/System Faults screen. The high pressure limit factory default setting is 80 psi (551.6 kPa).

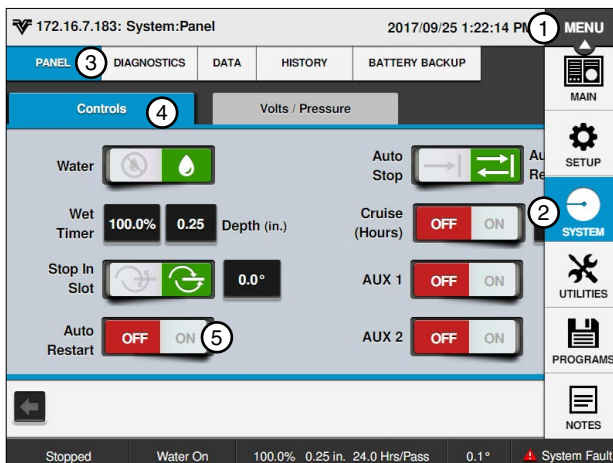

Figure 20-1 1. Menu 2. System 3. Panel 4. Controls 5. Auto Restart On

Pump (Continued)

Pump Settings

To change the Pump settings follow these steps:

1. Push **Menu, Setup, Constants, Pump & Pressure and Pump**. Refer to Figure 21-1.
2. To set the Auto Restart mode follow these steps:
 - a) Select the **Auto Restart Via** drop-down menu. Refer to Figure 21-1.
 - b) Choose the mode of restart from the drop-down menu.
 - » Pressure
 - » Power
 - » Both
3. To set the type of pumping unit follow these steps:
 - a) Select the **Pump Type** drop-down menu.
 - b) Choose the type of pumping unit:
 - » Engine Pump
 - » Electric Pump
4. To set the low pressure limit follow these steps:
 - a) Select the **Low Pressure** field.
 - b) Using the numeric keypad, enter a pressure value in either Pounds Per Square Inch (psi) or Kilopascal (kPa).
 - c) Push **Enter** to retain the value.

NOTE

- **If a mechanical pressure switch is used, the switch should be adjusted manually, and should indicate either an open condition (low pressure) or a closed condition (sufficient pressure). To select the type of pressure sensor to be used, refer to Pressure Sensor Setup in this section.**

5. To set the high pressure limit follow these steps:
 - a) Select the **High Pressure** field.
 - b) Using the numeric keypad, enter a pressure value in either Pounds Per Square Inch (psi) or Kilopascal (kPa).
 - c) Push **Enter** to retain the value.

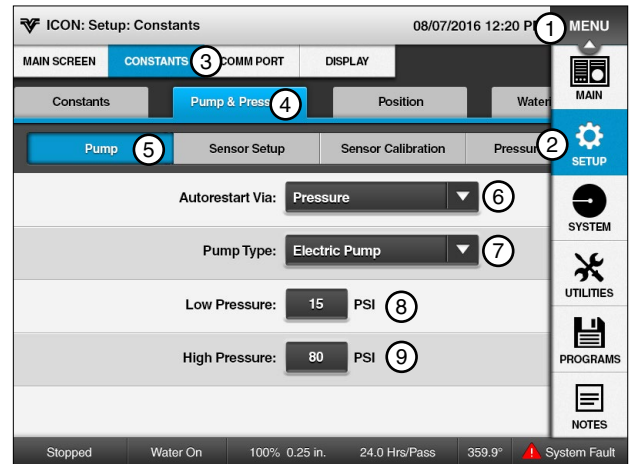

Figure 21-1

1. Menu	6. Auto Restart Via Drop-Down
2. Setup	7. Pump Type Drop-Down
3. Constants	8. Low Pressure
4. Pump	9. High Pressure
5. Pump	

Setup / Constants

Pump (Continued)

Sensor Setup

The Pressure Sensor Setup screen is used to identify which inputs are used when the machine is stopped or when the machine is running.

Push **Menu, Setup, Constants, Pump & Pressure**, and push the **Sensor Setup** button to display the Pressure Sensor Setup screen. Refer to Figure 22-1.

Types of Pressure Sensors

There are four types **Pressure Sensors** that can be used on the machine.

- Pressure (mV) - for millivolt pressure sensor
- Pressure (mA)- for milliampere pressure sensor
- Pressure Switch - for mechanical pressure switch
- Valley GPS Pressure Sensor

Setting Pressure Sensor

To set the pressure sensor type follow these steps:

1. Push **Menu, Setup, Constants, Pump & Pressure**, and push the **Sensor Setup** button to display the Pressure Sensor Setup screen.
2. Check the checkboxes next to the preferred inputs that will be used when the machine is stopped and check the checkboxes next to the preferred inputs that will be used when the machine is running.

NOTE

- If none of the boxes are checked the machine will run with Water on. If multiple sensors are checked for running, the machine will start after the first sensor reaches the low pressure limit. However if all sensors do not meet the low pressure limit before the pressure delay the machine will shut down.
- Valley GPS Pressure can be used as the only transducer on the system. It will be able to stop the pivot on pressure loss, but will not be able to do pressure restart.
- Valley GPS Pressure cannot be used to restart on water pressure. A transducer must be wired at the control panel and a "Stopped" transducer selected for this pressure restart.

CAUTION

- IF USING MORE THAN ONE PRESSURE SENSOR, WITH AUTORESTART VIA; SET TO EITHER PRESSURE OR BOTH, MAKE SURE THE PUMP HAS THE PROPER RESTART PROTECTION.

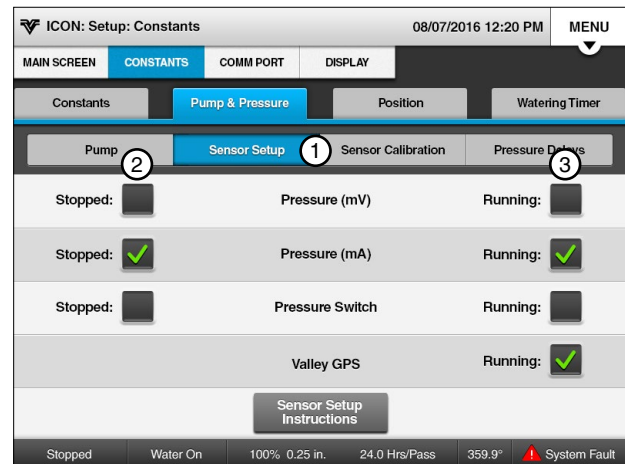

Figure 22-1 1. Sensor Setup
2. Stopped
3. Running

Pump (Continued)

Sensor Calibration

The Calibrate Pressure Sensor buttons are used to calibrate the pressure transducer to a water pressure reading of zero when the pump is off and the machine is dry.

Calibrating

To calibrate the pressure transducer to zero follow these steps:

1. Make sure the pump is off and the machine is dry.
2. Push **Menu, Setup, Constants, Pump & Pressure**, and push the **Sensor Calibration** button to display the Sensor Calibration screen. Refer to Figure 23-1.
3. Push the **Calibrate Pressure Sensor** button for sensor being used.
4. Push **Yes** to set the Water Pressure Sensor to the current water pressure of 0.

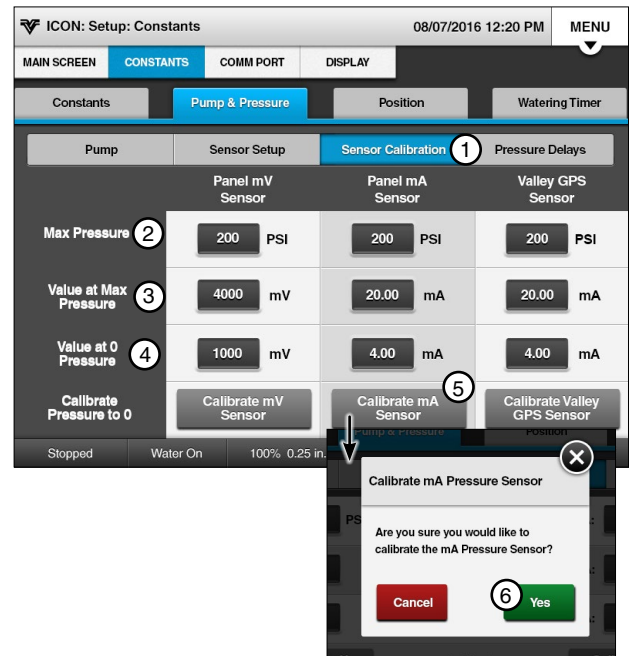

Figure 23-1 1. Sensor Calibration 4. Value at 0 Pressure
 2. Max Pressure 5. Calibrate Pressure Sensor
 3. Value at Max Pressure 6. Yes

Setup / Constants

Pump (Continued)

Pressure Delays Setup

The Pressure Delay Setup screen provides the ability to set the pressure delays for Startup, Operating, and High Pressure. Push **Menu**, **Setup**, **Constants**, **Pump & Pressure**, and push the **Pressure Delays** button to display the Pressure Delay Setup screen. Refer to Figure 24-1.

Startup Pressure Delay (seconds)

Startup Pressure Delay bypasses the pressure transducer for the amount of time required in seconds for the machine to initially build water pressure above the low pressure limit after the pump has been started. The Startup Pressure Delay setting has a range of 0 to 5000 seconds. The factory default is set to 600 seconds, or 10 minutes. Refer to Figure 24-1.

NOTE

- If a mechanical pressure switch is used, the Startup Pressure Delay constant must be entered as the amount of time required for the pressure switch to close.

Operating Pressure Delay (seconds)

Operating Pressure Delay is active only after the Startup Pressure Delay time setting has expired. The Operating Pressure Delay is the amount of time in seconds that the machine continues operating after pressure drops below the low pressure limit. The operating pressure delay has a range of 0 to 5000 seconds. The factory default is set to 30 seconds of continuous pressure loss. The operating pressure delay is reset when pressure rises above the low pressure limit.

If the water pressure does not reach the low pressure limit before the startup pressure delay expires, error code E06 Pressure Too Low After Pressure Delay is recorded, and the operating pressure delay takes over.

If the water pressure does not reach the low pressure limit before the operating pressure delay time expires, the machine is shut down due to a Low Pressure fault, which is displayed on the System/Diagnostics/System Faults screen.

High Pressure Delay (seconds)

The High Pressure Delay has a range of 0 to 255 seconds. The factory default is set to 3 seconds of continuous high pressure.

Setting Pressure Delays

To set the Startup, Operating, and High Pressure Delays follow these steps:

1. Push **Menu**, **Setup**, **Constants**, **Pump & Pressure**, and the **Pressure Delays** button to display the **Pressure Delays** screen. Refer to Figure 24-1.
2. Select the **Startup Pressure Delay**, **Operating Pressure Delay**, or **High Pressure Delay** field.
3. Using the numeric keypad, enter the delay time in seconds.
4. Push **Enter** to retain the value.
5. Repeat steps 2-4 for the other pressure delays.

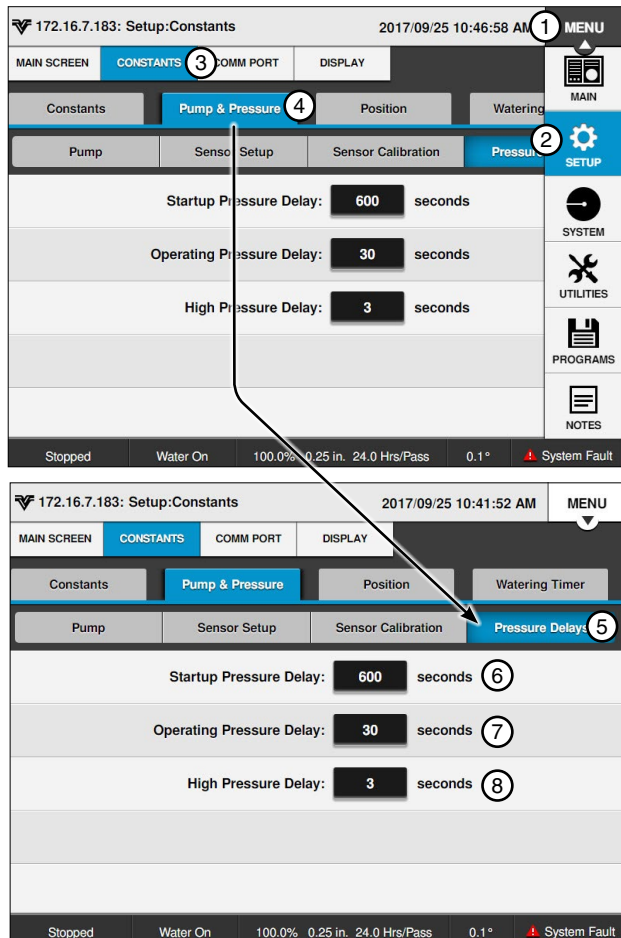

Figure 24-1 1. Menu 5. Pressure Delays
2. Setup 6. Startup Pressure Delay
3. Constants 7. Operating Pressure Delay
4. Pump & Pressure 8. High Pressure Delay

Position

The Position screen displays the Raw and Present pivot position in the field, defined as a degree location between 0.0° and 359.9°, and shown on the Main screen. Typically, the 0° pivot position is set to due north. However, any pivot location can be the 0° position.

Position Encoder

When using the Position Encoder, the RJ11 Comm Port Protocol must be set to the Position Encoder Protocol with baud rate set to 4800. Position Loss Constants are used to control the machine if signal loss occurs.

Refer to the Comm Port area of this section for information about setting up the Comm Port.

Setting Present Position

NOTE

- Changing the pivot position affects the location in the field from which the End Gun, Wide Boundary, Stop-In-Slot, and Programs are controlled.

To set the Present position follow these steps:

1. Push **Menu**, **Setup**, **Constants**, **Position** and **Pivot Position** to display the Position screen. Refer to Figure 25-1.
2. Push the **Calibrate** button.
3. Using the numeric keypad, enter the current pivot position from 0.0° to 359.9°.
4. Push **Enter** to retain the value.

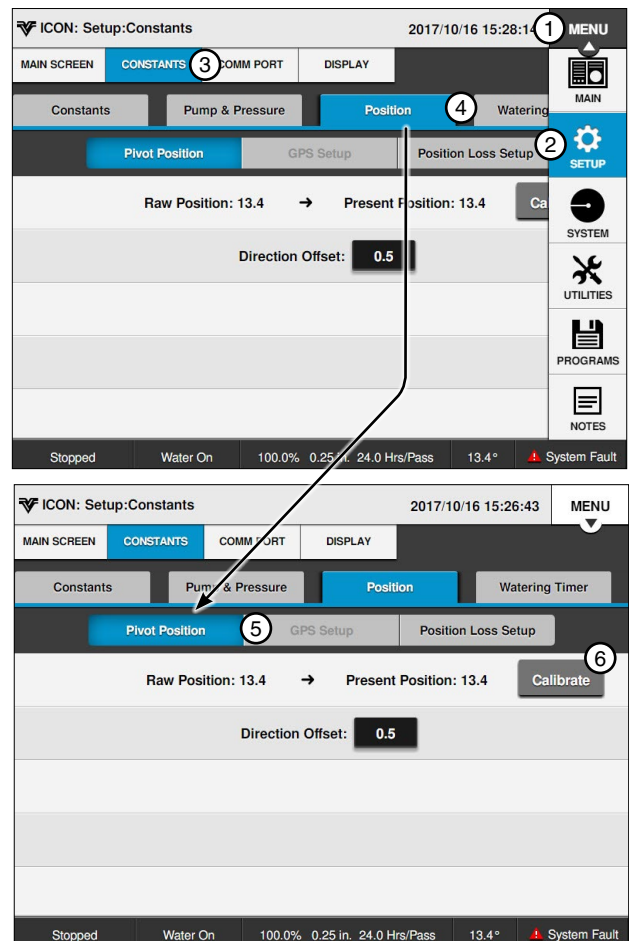

Figure 25-1 1. Menu 4. Position
2. Setup 5. Pivot Position
3. Constants 6. Calibrate

Setup / Constants

Position (Continued)

Position Encoder Direction Offset

Position Encoder Direction Offset (Direction Offset) is used to adjust, or offset, the actual pivot position of the machine so that the End Gun on/off locations, Wide Boundary On/Off locations, Stop-In-Slot locations, or any other position-based command locations are repeatable when the direction of the machine is changed. A repeatable accuracy of $\pm 1^\circ$ can be expected. The Direction Offset factory default setting is 0.5° and is adjustable from 0° to 10° .

Estimating the Direction Offset

If, after changing directions, the machine runs/stops past the normal End Gun On/Off locations, Wide Boundary On/Off locations, Stop-In-Slot location or any other position based program locations by an estimated value of 1.0° , the direction offset needs to be increased by $1/2$ of the estimated value, which in this case is 0.5° . Refer to Figure 26-1.

1. Measure the distance in feet from where the machine stopped to where it should have stopped. This is the measured offset.
Measured Offset _____
2. The table in Figure 26-2 lists the approximate length of a 1° offset, based on machine length. Find and record the approximate 1° offset for your machine length.
Approximate Offset _____
3. Calculate the value for the estimated offset, based on whether the machine runs/stops past or runs/stops short of the position. Then set the new direction offset. Refer to Figure 26-3.

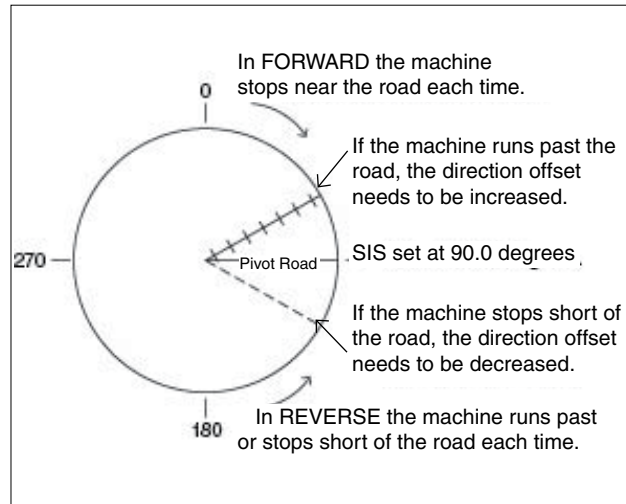

Figure 26-1

Machine Length (Feet)	115	230	345	460	575	690	805	920	1035	1150	1265	1380	1495	1610	1725
1 Degree Offset (Feet)	2	4	6	8	10	12	14	16	18	20	22	24	26	28	30

Machine Length (Meters)	35.0	70.1	105.1	140.2	175.2	210.3	245.3	280.4	315.4	350.5	385.5	420.6	455.6	490.7	525.7
1 Degree Offset (Meters)	0.6	1.2	1.8	2.4	3.0	3.6	4.2	4.8	5.4	6.0	6.7	7.3	7.9	8.5	9.1

Figure 26-2

Machine Runs/Stops Past Position:				Machine Runs/Stops Short of Position:			
Estimated Direction Offset	=	Current Direction Offset +	Measured (Offset) ÷ 2	Estimated Direction Offset	=	Current Direction Offset -	Measured (Offset) ÷ 2

Figure 26-3

Position (Continued)

Position Encoder Direction Offset (Continued)

Calculating Direction Offset

To calculate the direction offset value follow these steps:

1. Start the machine in the FORWARD or REVERSE running direction, and watch the position reading on the Main screen. For this example, the running direction used is REVERSE.

Stop the machine when the position changes by at least 7° . This indicates that the position encoder is now turning as the pivot rotates.

2. Place a flag next to the wheel track and in line with the center of the rear wheel on the first regular drive unit. This is position A. Refer to Figure 27-1.

In the running direction opposite to that in step 1, measure a distance of 50 feet from position A, along the first regular drive unit wheel track, and place another flag. This is position B. For this example, the opposite running direction is Forward

3. Push **Menu**, **Setup**, **Constants**, **Position** and **Pivot Position** to view the Present Position of the machine. Refer to Figure 27-2.

Record the position displayed in the position field to the nearest tenth of a degree as position A.

Position A = _____ Degrees

4. Start the machine in the running direction opposite of that in step 1, and let it run exactly 50 feet. The flag at position B should be in line with the center of the rear wheel on the first regular drive unit. Then, stop the machine.

5. Push **Menu**, **Setup**, **Constants**, and **Position** to view the position of the machine.

Record the position displayed in the Present Position field to the nearest tenth of a degree as position B.

Position B = _____ Degrees

6. Measure the distance in feet from the center of the pivot to the center line of the tire on the first regular drive unit. This distance is R. Refer to Figure 27-3.

R = _____ Feet

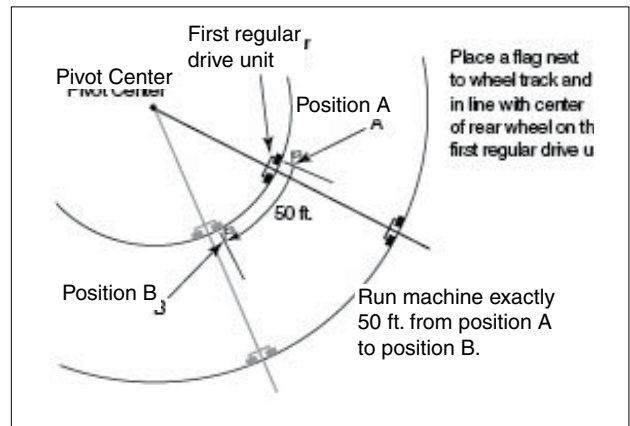

Figure 27-1



Figure 27-2 Pivot Position Screen
1. Present Position

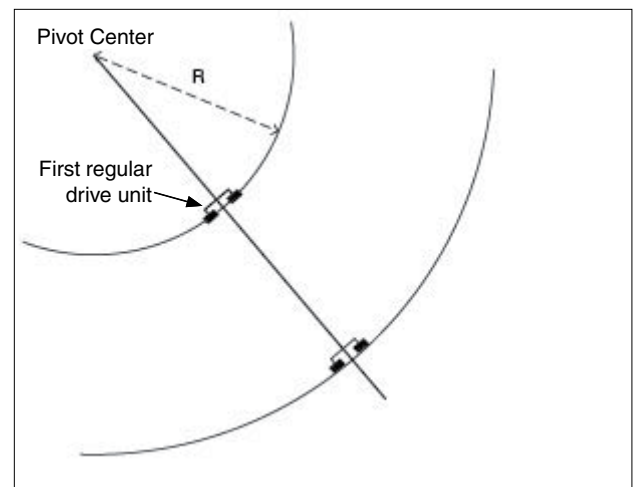

Figure 27-3

Setup / Constants

Position (Continued)

Position Encoder Direction Offset (Continued)

Calculating Direction Offset (Continued)

- Use the measured degrees formula to determine how many degrees the pivot should travel in 50 feet. This is the measured degrees. Refer to Figure 28-1.
- Use the actual degrees formula to determine the actual degrees traveled. This is the difference in readings between position A and position B.

NOTE: If this value is negative, drop the negative sign and use as a positive value.

- Push **Setup**, **Constants**, and **Position** to view the **Position** screen and the **Encoder Direction Offset** field. Refer to Figure 28-2.

Record the current direction offset displayed in the encoder direction offset field.

Current Direction Offset = _____

- Calculate the value for the new direction offset using one of the two formulas shown below. Then set the new direction offset. Refer to Figure 28-3.

Setting Encoder Direction Offset

To set the direction offset follow these steps:

- Push **Menu**, **Setup**, **Constants**, **Position**, and **Pivot Position** to display the Position screen. Refer to Figure 28-1.
- Select the **Encoder Direction Offset** field.
- Using the numeric keypad, enter the Position Encoder Direction Offset value in degrees.
- Push **Enter** to retain the value.

Measured Degrees Formula

$$\text{Measured Degrees} = (2864.8) / (R)$$

$$= (2864.8) / (\text{_____})$$

$$= \text{_____}$$

Actual Degrees Formula

$$\text{Actual Degrees} = \text{Position B} - \text{Position A}$$

$$= (\text{_____}) - (\text{_____})$$

$$= \text{_____}$$

Figure 28-1

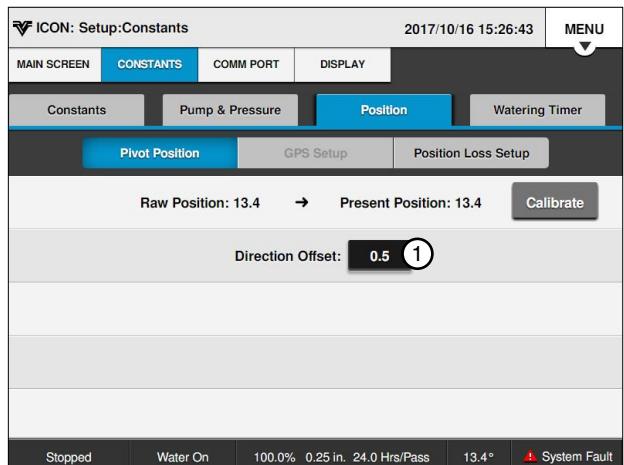

Figure 28-2 Position Screen
1. Encoder Direction Offset

If the actual degrees are LESS THAN the measured degrees use the formula below:

$$\text{New Direction Offset} = \text{Current Direction Offset} + \left[\frac{(\text{Measured Degrees}) - (\text{Actual Degrees})}{2} \right]$$

$$= \text{_____} + \left[\frac{(\text{_____}) - (\text{_____})}{2} \right]$$

$$= \text{_____} + \left[\frac{(\text{_____})}{2} \right]$$

$$= \text{_____} + \text{_____}$$

$$= \text{_____}$$

If the actual degrees are GREATER THAN the measured degrees use the formula below:

$$\text{New Direction Offset} = \text{Current Direction Offset} - \left[\frac{(\text{Actual Degrees}) - (\text{Measured Degrees})}{2} \right]$$

$$= \text{_____} - \left[\frac{(\text{_____}) - (\text{_____})}{2} \right]$$

$$= \text{_____} - \left[\frac{(\text{_____})}{2} \right]$$

$$= \text{_____} - \text{_____}$$

$$= \text{_____}$$

Figure 28-3

Position (Continued)

GPS Position

When using GPS position, the Communications (Comm) Port RJ-11 protocol must first be set up for GPS V2 or Valley GPS. The GPS position of the pivot point must then be set before setting Present Position in the field.

NOTE

•If the Communications (Comm) Port RJ-11 protocol is not set up for PLC GPS V2 or Valley GPS, the GPS Setup button will not be visible on the control panel. Refer to the Comm Port area of this section for information about setting up the Comm Port.

GPS Setup

Current Position

The current GPS latitude and GPS longitude of the GPS antenna is displayed at the top of the screen when it is locked on the satellite signal. The current position is only displayed when the Comm Port protocol is set to PLC GPS V2 or Valley GPS. Refer to Figure 29-1.

Pivot Point GPS

Pivot Point GPS displays the longitude and latitude of the pivot point. Pivot Point GPS is only displayed when the Comm Port protocol is set to PLC GPS V2 or Valley GPS.

Setting Pivot Point GPS

To set the pivot point GPS follow these steps:

1. Push **Menu**, **Setup**, **Constants**, **Position**, and **GPS Setup** to display the GPS Setup screen. Refer to Figure 29-1.

NOTE

- Latitude and Longitude positions displayed on a handheld GPS receiver are usually displayed as North, South, East or West.
- The direction displayed affects how the position is entered into the control panel.
- If the position is shown as West or South the position MUST be entered as a Negative Degree.
- In North America, latitude positions are always positive, and longitude positions are always negative.

2. Select the **Pivot Point GPS Latitude** field and enter the positions manually.
3. Push **Enter** to retain the value.
4. Repeat steps 2 and 3 for the **Pivot Point GPS Longitude** field.

Satellite Lock

Satellite Lock displays the satellite signal (No GPS, Standard, or DGPS) that the GPS antenna is locked on.

Count

Count displays the number of satellites in view.

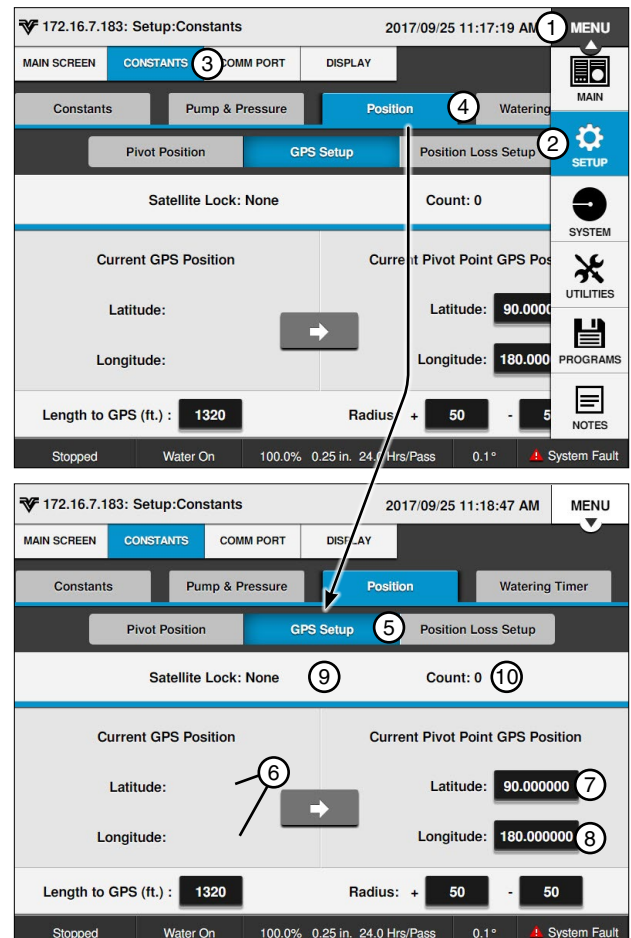

Figure 29-1 1. Menu 2. Setup 3. Constants 4. Position 5. GPS Setup 6. Current Position 7. Latitude 8. Longitude 9. Satellite Lock 10. Count

Setup / Constants

Position (Continued)

GPS Position (Continued)

GPS Setup (Continued)

Length to GPS

Length to GPS is the length from the pivot point to the GPS antenna or GPS tower box.

Setting the Distance to GPS (The distance from pivot point to GPS tower box).

To set the set the distance to the GPS follow these steps:

1. Push **Menu, Setup, Constants, Position** and **GPS Setup** to display the GPS Setup screen. Refer to Figure 30-1.
2. Select the **Length to GPS** field.
3. Using the numeric keypad, enter the length from the pivot point to the GPS antenna or GPS tower box. Do not enter the pivot length. The default is 1320 ft (402.3 m), and the range is 10 to 6554 ft (3.0 to 1997.6 m). Refer to Figure 30-1.
4. Push **Enter** to retain the value.
5. Select the **Radius +** field.
6. Using the numeric keypad, enter the Plus tolerance for the length outside the GPS antenna that the panel will accept satellites. The Default is 50 ft (15.2 m) and the range is 10 to 6554 ft (3.0 to 1997.6 m). A setting of 50 ft (15.2 m) or more is recommended to allow for variation in the GPS signal if Wide Area Application Services (WAAS) is unavailable. Refer to Figure 30-1.
7. Push **Enter** to retain the value.
8. Select the **Radius -** field.
9. Using the numeric keypad, enter the Minus tolerance for the length inside of the GPS antenna that the panel will accept satellites. The Default is 50 ft (15.2 m) and the range is 10 to 6554 ft (3.0 to 1997.6 m). A setting of 50 ft (15.2 m) or more is recommended to allow for variation in the GPS signal if WAAS is unavailable.
10. Push **Enter** to retain the value.

Setting Present Position

NOTE

•Changing the pivot position affects the location in the field from which the End Gun, Stop-In-Slot, and Programs are controlled.

To set the Present position follow these steps:

1. Push **Menu, Setup, Constants, Position** and **Pivot Position** to display the Position screen. Refer to Figure 30-2.
2. Push the **Calibrate** button.
3. Using the numeric keypad, enter the current pivot position from 0.0° to 359.9°.
4. Push **Enter** to retain the value.

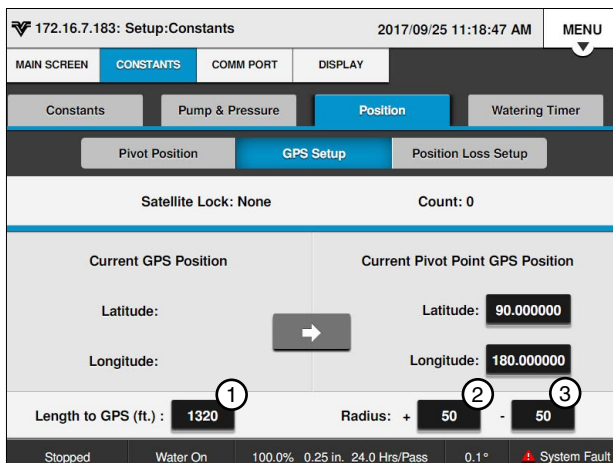

Figure 30-1 GPS Screen
1. Length to GPS
2. Radius +
3. Radius -

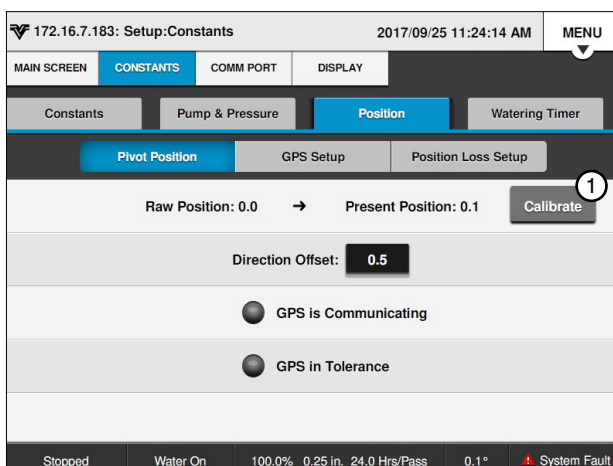

Figure 30-2 Pivot Position Screen
1. Calibrate

Position (Continued)

Position Loss Setup

The Position Loss Setup screen is used with Position Encoder and GPS Position. If the machine loses a signal, or has a loss of communication, three different position loss functions can be used independently, or with each other, to control the machine operation.

To access these functions, push **Menu**, **Setup**, **Constants**, **Position** and **Position Loss Setup**.

- **System Shutdown:** When checked, shuts the system down if the position is lost for a specified period of time. The default setting is checked (enabled) with a 20-minute delay.
- **Disable Endguns:** When checked, disables the end guns if the position is lost for a specified period of time. The default setting is unchecked (disabled) with a 10-minute delay.
- **Fallback Position:** When checked, if the position is lost, the position is calculated using Runtime until the position is re-acquired. The default setting is checked (enabled) with Runtime.

System Shutdown

To set up a shutdown of the system, do the following:

1. Check the **System Shutdown** checkbox. See Figure 31-1.
2. Select the Shutdown System **Delay Time** field and enter the number of minutes (1 to 255) on the numeric keypad. The default is 20 minutes.
3. Push **Enter** to retain the value.

Disable Endguns

To set up the disabling of end guns, do the following.

1. Check the **Disable Endguns** checkbox. See Figure 31-1.
2. Select the Disable Endguns **Delay Time** field and enter the number of minutes (1 to 255) on the numeric keypad. The default is 10 minutes.
3. Push **Enter** to retain the value.

Runtime Fallback Position

To set up the fallback position, do the following.

1. Check the **Runtime Fallback Position** checkbox. See Figure 31-1.
2. Select the **LRDU Pivot Speed** field and enter the speed on the numeric keypad. The default is 15.56 ft/min.
3. Select the **Length to LRDU** field and enter the length on the numeric keypad. The default is 1320 ft (402.3 m).
4. Push **Enter** to retain the value.

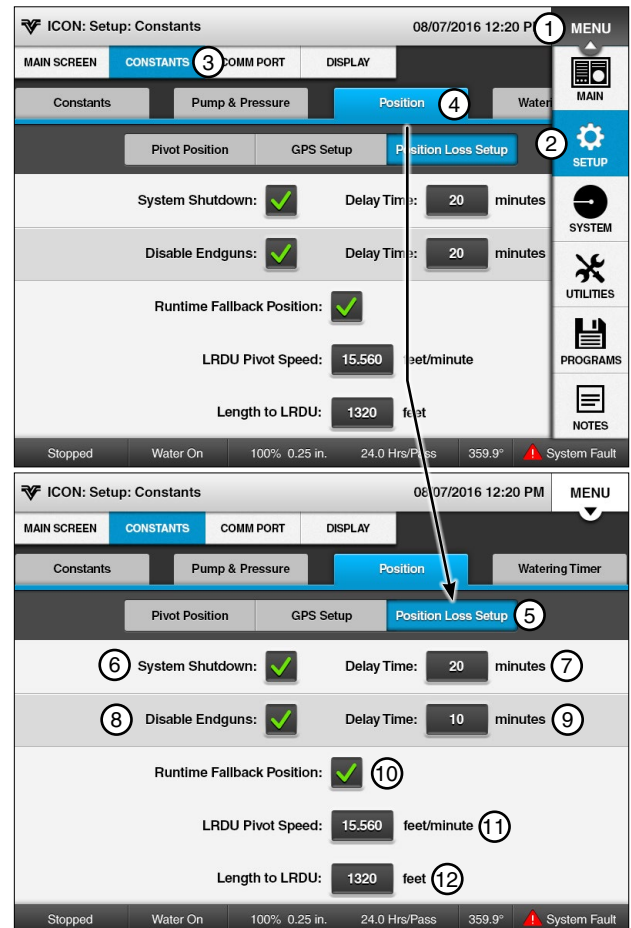

Figure 31-1 1. Menu 7. System Shutdown Delay
 2. Setup 8. Disable End Guns
 3. Constants 9. Disable End Guns Delay
 4. Position 10. Runtime Fallback Position
 5. Position Loss Setup 11. LRDU Pivot Speed
 6. System Shutdown 12. Length to LRDU

Setup / Constants

Watering Timer

Watering Timer provides separate timers for over-watering and under-watering conditions, and is used to monitor and control both. The Watering Timer feature is available for use with either GPS Position or Position Encoder.

Watering Timer Enable/Disable

1. Push **Menu**, **Setup**, **Constants**, and **Watering Timer** to display the Watering Timer screen. Refer to Figure 32-1.
2. Check the **Watering Timer** checkbox to enable the Watering Timer. The default value is Watering Timer disabled (unchecked).

NOTE

- The Watering Timer functions only when the machine is running with Water on, and after the Startup Pressure Delay time period.

Watering Timer Status

To view the status of the watering timers, push **Menu**, **Setup**, **Constants**, and **Watering Timer** to display the Watering Timer screen. Refer to Figure 32-1.

Overwater Timer @ 100%

- Run Timer - Time the machine has run without moving. Run Timer only increments when water and percent timer output is on. Run Timer resets every 0.1°, or with a change in direction.
- Shutdown Time - Time at which the machine is shut down because of lack of movement.

Underwater Timer @ 100%

- 5° Run Timer - Calculated time for machine to travel 5° at 100%. 5° Run Timer only increments when water and percent timer output is on.
- 5° Run Timer resets after 5° of travel.
- Error Time - Actual travel time, if faster than calculated time. Then, an underwatering error is logged.

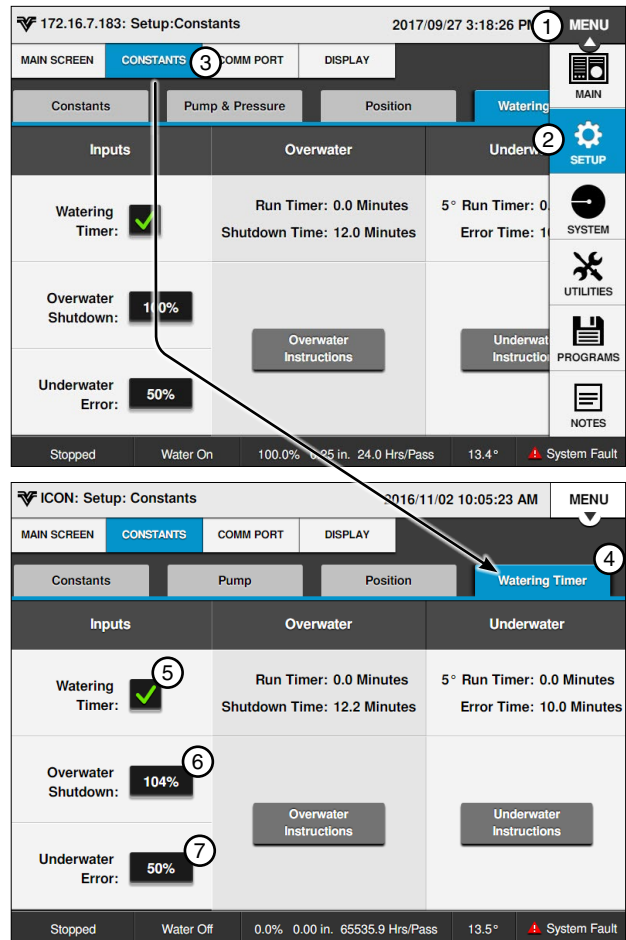

Figure 32-1 1. Menu 5. Watering Timer Checkbox
 2. Setup 6. Overwater
 3. Constants 7. Underwater
 4. Watering Timer

Watering Timer (Continued)

Overwater Shutdown (%)

Overwater Shutdown allows the irrigation system to be shut down if the machine is moving too slowly, or not moving at all. Typically the overwatering timer would trigger because the end tower stopped moving, thereby applying too much water to all, or parts of the field.

The Overwatering Timer resets every tenth of a degree (0.1°) of movement and with a change in direction. It only increments if the Percentage Timer output is on, and after the Startup Pressure Delay time period. The default Overwater Shutdown percent is 100%.

1. To set the Overwater Shutdown, push **Menu, Setup, Constants, Watering Timer** to display the Watering Timer screen.
2. Select the Overwater Shutdown field. Refer to Figure 33-1.
3. Using the numeric keypad, enter the Overwater Shutdown number of minutes. The range is 3.4 to 102.4.

Push **Enter** to retain the value.

Overwater Timer Instructions

To view the Overwater Timer Instructions, push **Menu, Setup, Constants, Watering Timer** and push the **Overwater Instructions** button. Refer to Figure 33-1.

Underwater Error (%)

Underwater Error creates an error if the irrigation system is moving faster than it should, thereby applying less water to all, or parts of the field.

The Underwater Timer resets every five degrees (5°) of movement, and with a change in direction. It only increments if the Percentage Timer output is on, and after the Startup Pressure Delay time period. The default Underwater Error percent is 50%.

1. To set the Underwater Error, push **Menu, Setup, Constants, and Watering Timer** to display the Watering Timer screen. Refer to Figure 33-1.
2. Select the **Underwater Error** field.
3. Using the numeric keypad, enter the percent of Underwater. The range is 1-255%.
4. Push **Enter** to retain the value.

Underwater Timer Instructions

To view the Underwater Timer Instructions, push **Menu, Setup, Constants, Watering Timer** and push the **Underwater Timer Instructions** button. Refer to Figure 33-1.

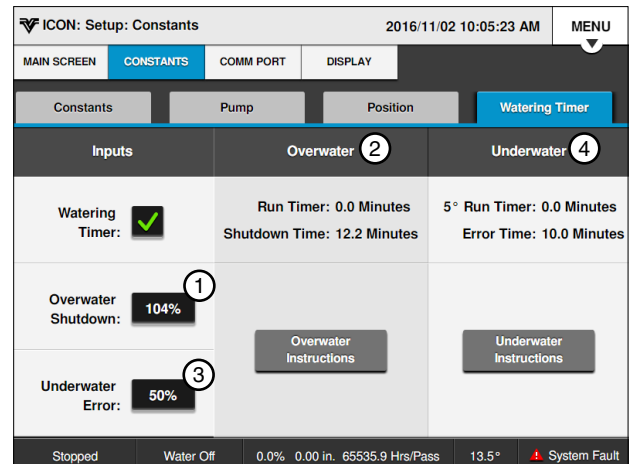

Figure 33-1 1. Overwater Shutdown
2. Overwater Instructions
3. Underwater Error
4. Underwater Instructions

Setup / Comm Port

Comm Port

Comm Port is used to set the control panel communications port, protocol, and baud rate for information that is transmitted and received when communicating with another device. There are four Comm Ports to pick from; DB9, DB9-Y, RJ11, and Spare. Options vary for each Comm Port.

DB9

The DB9 Comm Port is used as the telemetry connection for remote communications. The protocol default setting is VCP, and the baud rate default setting is 9600. Protocol options include VCP and None. Refer to Figure 34-1.

DB9-Y

The DB9-Y Comm Port is used for direct connections to an option. **The use of the DB9-Y Comm Port requires special cabling** and is being developed for future options. The protocol default setting is None, and the baud rate default setting is 9600. Protocol options include VRI-iS, PLC, Position Encoder, VCP and Valley GPS. Refer to Figure 34-1.

RJ11

The RJ11 Comm Port is used for direct connections to an option. The protocol default setting is Position Encoder, and the baud rate default setting is 4800. Protocol options include PLC, Position Encoder, VRI-iS and Valley GPS. Refer to Figure 34-1.

SPARE

The use of Spare Comm Port requires special cabling and is being developed for future options. The protocol default setting is None, and the baud rate default setting is 115200. Protocol options include VCP and None. Refer to Figure 34-1.

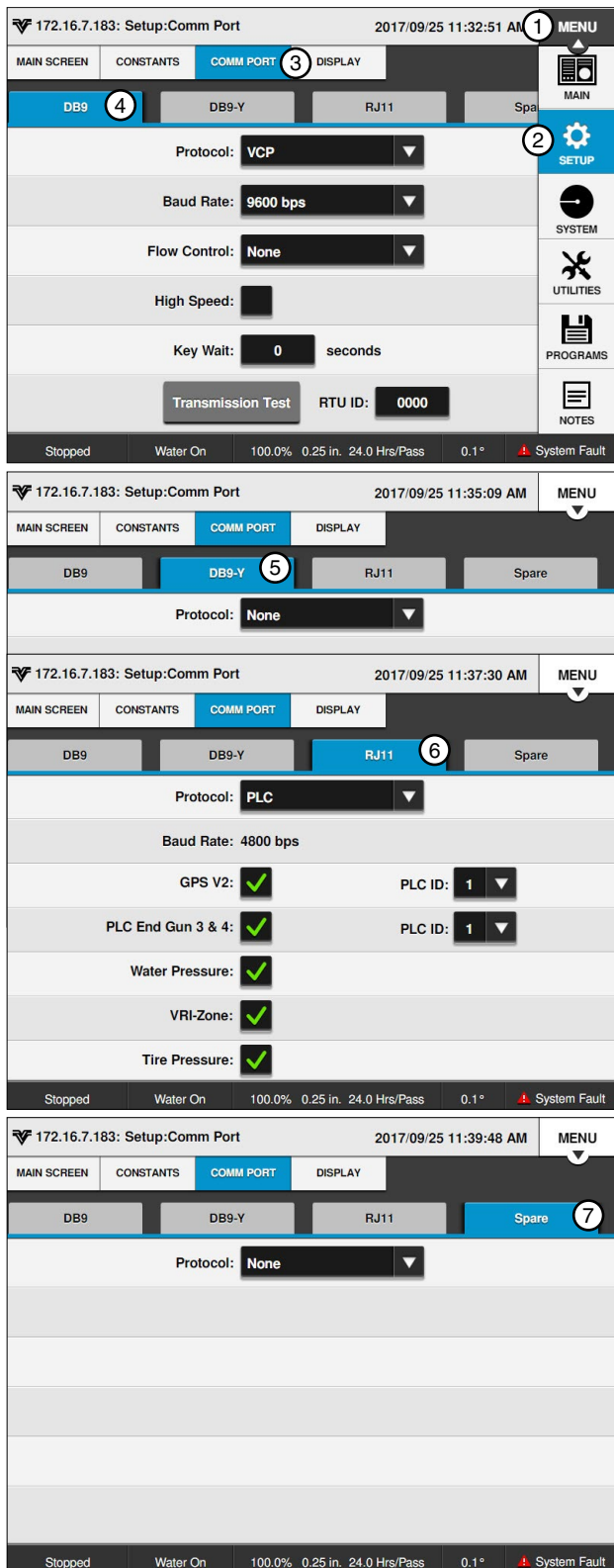

Figure 34-1 1. Menu 2. Setup 3. Comm Port 4. DB9 Protocol 5. DB9-Y Protocol 6. RJ11 Protocol 7. Spare Comm Port Protocol

Protocol and Baud Rate

To set the Communications Port, Protocol, and Baud Rate follow these steps:

1. Push **Menu**, **Setup**, **Comm Port**, and either **DB9**, **DB9-Y**, **RJ11**, or **SPARE**.
2. Select the **Protocol** drop-down menu.
3. Choose the desired protocol from the Protocol drop-down menu.

NOTE

- The VCP protocol can be used on multiple Comm Ports simultaneously.
- All other protocols can only be used by one Comm Port at a time.

4. Select the **Baud Rate** drop-down menu and choose the desired baud rate for the Comm Port. Depending on the Protocol, other parameters like Flow Control, High Speed, and Key Wait may need to be set, or additional options may need to be selected on the PLC (Power Line Carrier) and Valley GPS screen.

VRI-iS Protocol

VRI-iS used to set the protocol for the VRI-iS option. Protocol must be set prior to enabling VRI-iS in programs. Refer to Figure 35-2.

To set the VRI-iS Protocol follow these steps:

1. Push **Menu**, **Setup**, **Comm Port**, and **RJ11** (recommended) or **DB9-Y** (requires special cabling).
2. Select the **Protocol** drop-down menu.
3. Choose **VRI-iS**.
4. Select the **Baud Rate** drop-down menu.
5. Choose **4800 bps**.

Position Encoder Protocol

Position Encoder is used to set the Protocol for Position Encoder option. Position Loss Constants are used to control the machine if signal loss occurs. Refer to Figure 35-3.

To Set the Position Encoder Protocol follow these steps:

1. Push **Menu**, **Setup**, **Comm Port**, and **RJ11** (recommended) or **DB9-Y** (requires special cabling).
2. Select the **Protocol** drop-down menu.
3. Choose **Position Encoder**.
4. Select the **Baud Rate** drop-down menu.
5. Choose **4800 bps**.

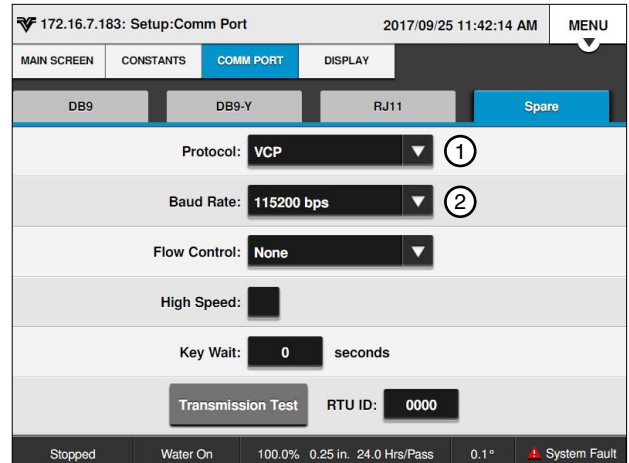

Figure 35-1 Spare Comm Port Screen
1. Protocol Drop-Down
2. Baud Rate Drop-Down

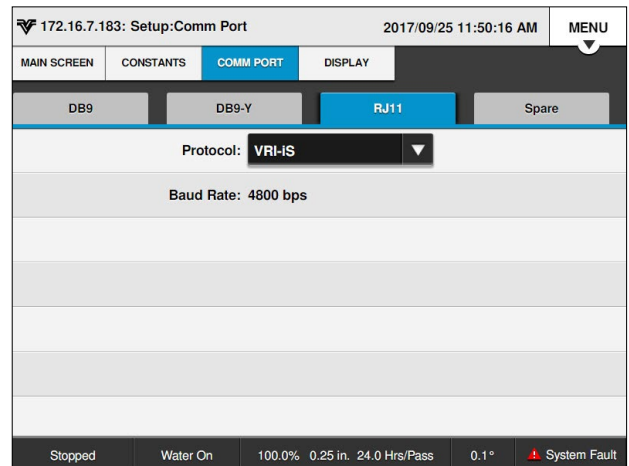

Figure 35-2 VRI-iS Protocol

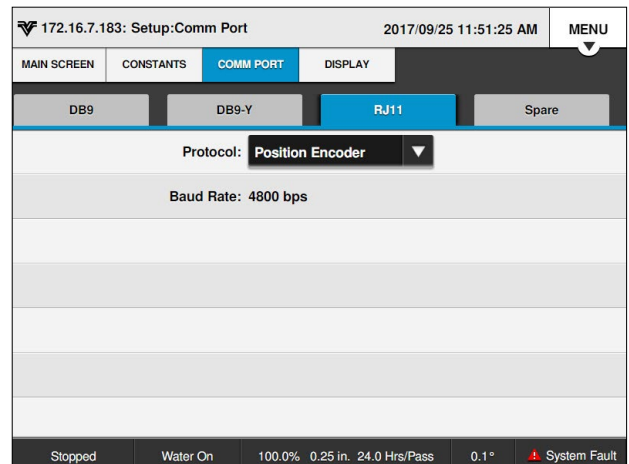

Figure 35-3 Position Encoder Protocol

Setup / Comm Port

Valley GPS Protocol

Valley GPS is used with the Valley GPS, PLC End-Gun 3 / 4, Valley GPS Pressure, Tire Pressure, and VRI Zone.

Valley GPS

Valley GPS is used for the GPS Position option and requires an OPMC5 power line carrier in the control panel. Position Loss constants are used to control the machine if signal loss occurs.

- The Valley GPS PLC ID identifies the Valley GPS.
- The Valley GPS includes PLC End Gund 3 / 4.
- Up to three Valley GPS can be used on one machine. The Intermediate Valley GPS devices could be used to locate PLC End Gun 3 & 4 or VGPS Water Pressure on a different tower or span than the GPS.

In order to use Valley GPS, Valley GPS options (PLC End Gun 3 and 4, VGPS Water Pressure), Tire Pressure or VRI-Zone a Device Discovery must be ran.

Valley GPS and Device Discovery

To run Device Discovery refer to Figure 36-1 and do the following:

1. **Ensure that any other machine that shares the same 480 VAC source, has either been running longer than five minutes or is powered off.**
2. Power cycle the control panel by turning the control panel disconnect off and then on.
3. Turn Water off.
4. Set the Dry % Timer to 0.0 (zero percent).
5. Push a Start button to start the machine, energize the safety circuit and the Valley GPS. The machine should not move.
6. Comm Port setup, push **Menu / Setup/ Comm Port** and **RJ11**.
7. Select the **RJ11 Protocol** field and choose **Valley GPS** from the drop-down list.
8. Push the **Valley GPS Device List** button.
9. Enter the Number of Devices Installed.
When only one Valley GPS is installed, enter 1.
When other Valley GPS options are installed, enter the total number of devices, up to 254.
10. Push the Discover Devices button. The control panel attempts to locate the devices.
Discovery of devices can typically take between three and six minutes.



Figure 36-1 1. Valley GPS Protocol
2. Valley GPS Device List

NOTE

- The Discover Devices button must be pushed with five minutes of starting the machine. If the machine has been running longer than five minutes, stop the machine and restart it.

Valley GPS Protocol (continued)

Valley GPS Device Discovery

11. After the devices have been discovered, note the PLC ID of all the devices shown on the Discovery section.
12. Push **Return** to close the Valley GPS Device List.
13. Push the **Valley GPS Setup** button.
14. Check the **Valley GPS** checkbox to enable GPS position.
15. Enter the PLC ID for Valley GPS.
16. **Optional: Enable PLC End Gun 3 & 4 Protocol.**

The Valley GPS supports the PLC End Gun 3 / 4 option. Connection to an external device is required.

To enable or disable End Gun 3 or 4, or configure left and right angles, push Menu and End Guns.

- a) If PLC End Gun 3 & 4 will be utilized, check the **PLC End Gun 3 & 4** checkbox to enable the protocol.
- b) Enter the **PLC End Gun 3 / 4 PLC ID** of the Valley GPS that is being used for PLC End Gun 3 / 4.

17. **Optional: Enable VGPS Water Pressure Protocol.**

Valley GPS supports the VGPS Water Pressure option (requires optional pressure transducer). VGPS Water Pressure is used to set the protocol for the Water Pressure option.

Valley GPS Pressure Sensor setup and calibration are available in Menu/Setup/ Constants/ Pump / Pressure.

- a) If VGPS Water Pressure will be installed, check the **VGPS Water Pressure** checkbox to enable the protocol.
- b) Enter the **PLC ID** of the Valley GPS that is being used for VGPS Water Pressure.

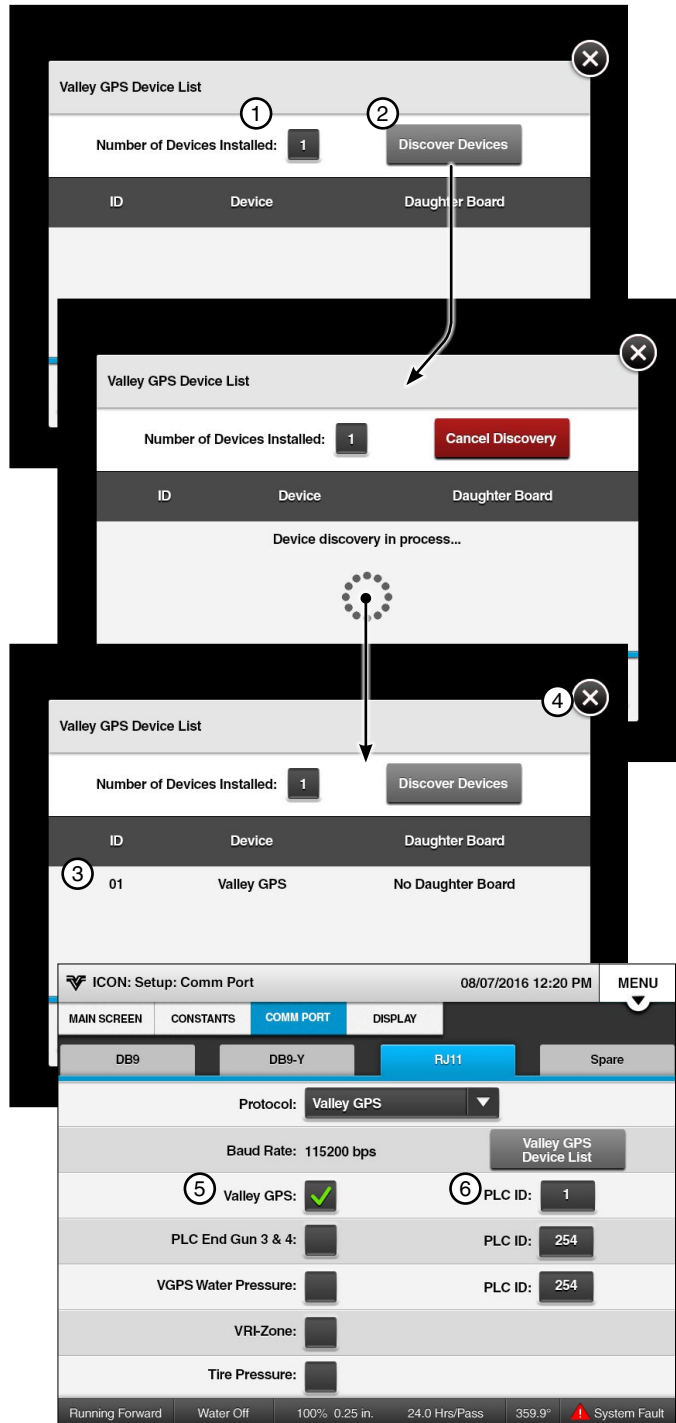

Figure 37-1 1. Enter Number of Devices
 2. Push Discover Devices
 3. Note PLC ID
 4. Close Valley GPS Device List
 5. Check Valley GPS
 6. Enter PLC ID

Setup / Comm Port

Valley GPS Protocol (continued)

Valley GPS Device Discovery

18. Optional: Enable Tire Pressure Protocol.

Tire Pressure is used to set the protocol for the Tire Pressure Monitor option. The TPMS option for ICON control panels is required. Refer to Figure 38-1.

Constants settings, Diagnostics, and Data for Tire Pressure are available in Utilities/TPMS.

Device Discovery is required.

- a) If Tire Pressure will be installed, check the **Tire Pressure** checkbox to enable the protocol.

19. Optional: Enable VRI-Zone Protocol.

VRI-Zone is used to set the protocol for the VRI-Zone option. The VRI-Zone option for ICON control panels is required. Refer to Figure 38-1.

The protocol must be set prior to enabling VRI-Zone in Programs.

Device Discovery is required.

- a) If VRI-Zone will be installed, check the **VRI-Zone** checkbox to enable the protocol.

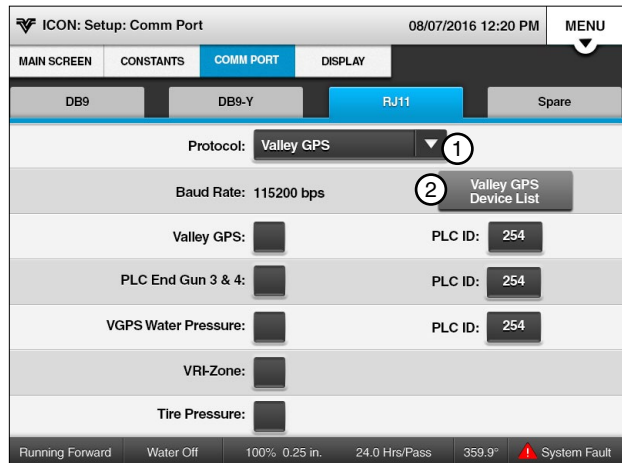

Figure 38-1 1. Valley GPS Protocol
2. Valley GPS Device List

PLC End Guns 3 & 4

PLC End Gun 3 / 4 is used to set the protocol for End Guns 3 / 4 and GPS Position option. The PLC End Gun tower box contains a GPS antenna.

- PLC End Gun 3 / 4 can be used with VRI-Zone as long as there are no more than 14 VRI-Zone boxes (28 zones).
- To enable or disable an End Gun or configure left and right angles, push Menu/End Guns.

To enable PLC End Gun 3 / 4 follow these steps:

1. Push **Menu**, **Setup**, **Comm Port**, and **RJ11** (recommended) or **DB9-Y** (requires special cabling), change the Comm Port Protocol to **Valley GPS**.
2. Check the **PLC End Gun 3 / 4** checkbox to enable.
 - However, if VRI-Zone is enabled, the PLC ID number cannot be changed. Record PLC End Gun 3 / 4 Tower Box ID _____.
3. Push **Enter** to retain the value.
4. If necessary, change the PLC ID number to match the PLC End Gun 3 / 4 PLC ID.
5. Push **Enter** to retain the value.

VGPS Water Pressure

VGPS Water Pressure is used to set the protocol for the VGPS Water Pressure option.

To enable VGPS Water Pressure follow these steps:

1. Push **Menu**, **Setup**, **Comm Port**, and **RJ11** (recommended) or **DB9-Y** (requires special cabling), change the Comm Port Protocol to **Valley GPS**.
2. Check the **VGPS Water Pressure** checkbox to enable the monitoring system. Refer to Figure 39-1.

VRI-Zone

VRI-Zone is used to set the protocol for the VRI-Zone option. Refer to Figure 39-1.

- The protocol must be set prior to enabling the VRI-Zone in Programs.

To enable the VRI-Zone follow these steps:

1. Select **Menu**, **Setup**, **Comm Port**, and **RJ11** (recommended) or **DB9-7** (requires special cabling), change the Comm Port Protocol to **Valley GPS**.
2. Check the **VRI-Zone** checkbox to enable.

Tire Pressure

Tire Pressure is used to set the protocol for the Tire Pressure Monitor option. Constants for Tire Pressure Monitor are set on the Tire Pressure Monitor screen in Utilities/TPMS.

- Constants, Diagnostics, and Data for Tire Pressure are available in Utilities/TPMS.

To enable TPMS Tire Pressure follow these steps:

1. Select **Menu**, **Setup**, **Comm Port**, and **RJ11** (recommended) or **DB9-Y** (requires special cabling), change the Comm Port Protocol to **Valley GPS**.
2. Check the **Tire Pressure** checkbox to enable the monitoring system. Refer to Figure 39-1.

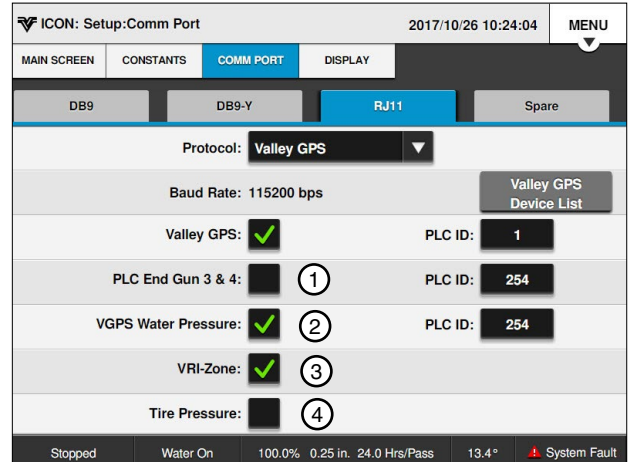

Figure 39-1 1. PLC End Guns 3 & 4 3. Tire Pressure
1. VGPS Water Pressure
2. VRI-Zone

Setup / Comm Port

Valley GPS Device List

The Valley GPS Device List, once the devices are discovered, shows the devices connected to the Valley GPS. The ID is used to set up the PLC ID.

Refer to Figures 40-1 and 40-2.

PLC ID

The PLC ID identifies the Valley GPS. The default PLC ID is 01. Position Loss constants are used to control the machine if signal loss occurs.

- If PLC End Gun 3 / 4 is used with Valley GPS position, the Valley GPS protocol should be enabled. PLC End Gun 3 / 4 because the Valley GPS PLC ID must be the same as the PLC End Gun 3 / 4 PLC ID.

Setting the PLC ID

To set the PLC ID constant follow these steps:

1. Select the **PLC ID** field. Refer to Figure 40-1.
2. Using the numeric keypad, enter the PLC ID.
3. Push **Enter** to retain the value.

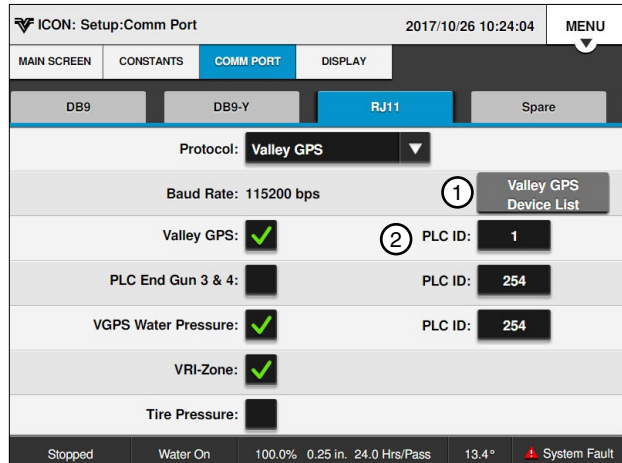

Figure 40-1 1. Valley GPS Device List
2. PLC ID

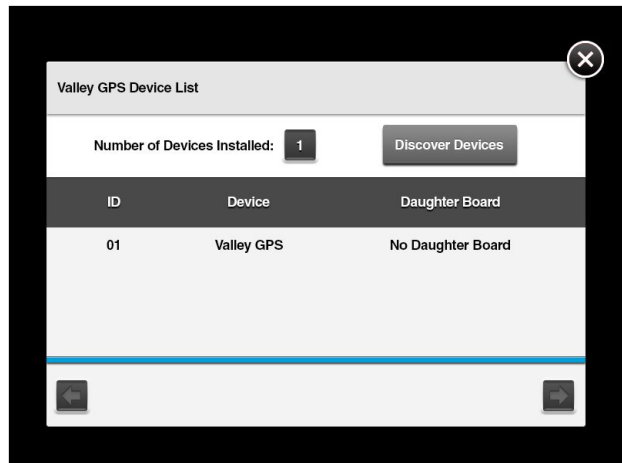

Figure 40-2 Valley GPS Device List

PLC Protocol

PLC (Power Line Carrier) is used with GPS V2, PLC End Gun 3 / 4, Water Pressure, Tire Pressure, and VRI-Zone.

1. Push **Menu**, **Setup**, **Comm Port**, and **RJ11** (recommended) or **DB9-Y** (requires special cabling).
2. Select the **Protocol** drop-down menu. Refer to Figure 41-1.
3. Push the **PLC Setup** button to display the PLC Setup screen. Refer to Figure 41-1.

GPS V2

GPS V2 is used to set protocol for the GPS Position option. The power line carrier must be running version 2 software. Position Loss constants are used to control the machine if signal loss occurs.

- The GPS V2 PLC ID identifies the tower box that the GPS antenna is in. The default PLC ID is 01.
- If PLC End Gun 3 / 4 is used with GPS position, the GPS V2 protocol should be enabled. PLC End Gun 3 / 4 because the GPS V2 PLC ID must be the same as the PLC End Gun 3 / 4 PLC ID.

To enable GPS V2 follow these steps:

1. Push **Menu**, **Setup**, **Comm Port**, and **DB9-Y**.
2. Select PLC from the Comm Port Protocol drop-down menu.
3. Push the **PLC Setup** button to display the PLC Setup screen. Refer to Figure 41-1.
4. Check the **GPS V2** checkbox to enable.
5. Select the **GPS V2 PLC ID** field.
6. Using the numeric keypad, enter the PLC ID tower box number.
7. Push **Enter** to retain the value.

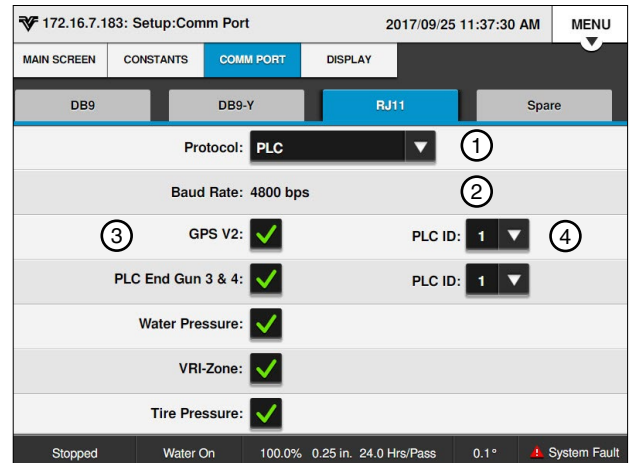

Figure 41-1 PLC Setup Screen
 1. Protocol Drop-Down
 2. Baud Rate Drop-Down
 3. GPS V2 Checkbox
 4. GPS V2 PLC ID

Setup / Comm Port

PLC End Gun 3 / 4

PLC End Gun 3 / 4 is used to set the protocol for End Guns 3 / 4 and GPS Position option. The PLC End Gun tower box contains a GPS antenna.

- PLC End Gun 3 / 4 can be used with VRI-Zone as long as there are no more than 14 VRI-Zone boxes (28 zones).
- To enable or disable an End Gun or configure left and right angles, push Menu/End Guns.

To enable PLC End Gun 3 / 4 follow these steps:

1. Push **Menu**, **Setup**, **Comm Port**, and **RJ11** (recommended) or **DB9-Y** (requires special cabling), change the comm port protocol to PLC and push the **PLC Setup** button to display the PLC screen. Refer to Figure 42-1.

2. Check the **PLC End Gun 3 / 4** checkbox to enable.

However, if VRI-Zone is enabled, the PLC ID number cannot be changed. Record PLC End Gun 3 / 4 Tower Box ID _____.

3. Push **Enter** to retain the value.
4. If necessary, change the GPS V2 PLC ID number to match the PLC End Gun 3 / 4 PLC ID.
5. Push **Enter** to retain the value.

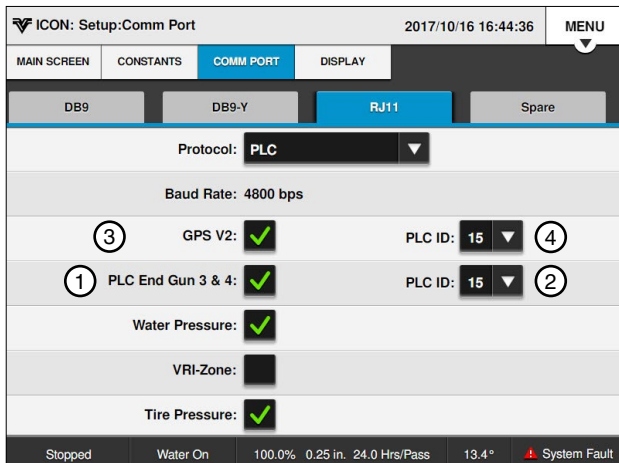

Figure 42-1 PLC Setup Screen
1. PLC End Gun 3 / 4 Checkbox
2. PLC End Gun 3 / 4 PLC ID
3. GPS V2 Checkbox
4. GPS V2 PLC ID

Water Pressure

Water Pressure is used to set the protocol for the Water Pressure option.

- Constants, Diagnostics, and Data for Water Pressure are available in Utilities/TPMS.

To enable Water Pressure follow these steps:

1. Push **Menu**, **Setup**, **Comm Port**, and **RJ11** (recommended) or **DB9-Y** (requires special cabling), change the comm port protocol to PLC and push the **PLC Setup** button to display the PLC screen.
2. Check the **Water Pressure** checkbox to enable the monitoring system. Refer to Figure 43-1.

Tire Pressure

Tire Pressure is used to set the protocol for the Tire Pressure Monitor option. Constants for Tire Pressure Monitor are set on the Tire Pressure Monitor screen in Utilities/TPMS.

- Constants, Diagnostics, and Data for Tire Pressure are available in Utilities/TPMS.

To enable TPMS Tire Pressure follow these steps:

1. Select **Menu**, **Setup**, **Comm Port**, and **RJ11** (recommended) or **DB9-Y** (requires special cabling), change the Comm Port Protocol to PLC and push the **PLC Setup** button to display the PLC screen.
2. Check the Tire Pressure checkbox to enable the monitoring system. Refer to Figure 43-1.

VRI-Zone

VRI-Zone is used to set the protocol for the VRI-Zone option. Refer to Figure 43-1.

- The protocol must be set prior to enabling VRI-Zone in Programs.

To enable VRI-Zone follow these steps:

1. Select **Menu**, **Setup**, **Comm Port**, and **RJ11** (recommended) or **DB9-Y** (requires special cabling), change the Comm Port Protocol to PLC and push the **PLC Setup** button to display the PLC screen.
2. Check the **VRI-Zone** checkbox to enable.

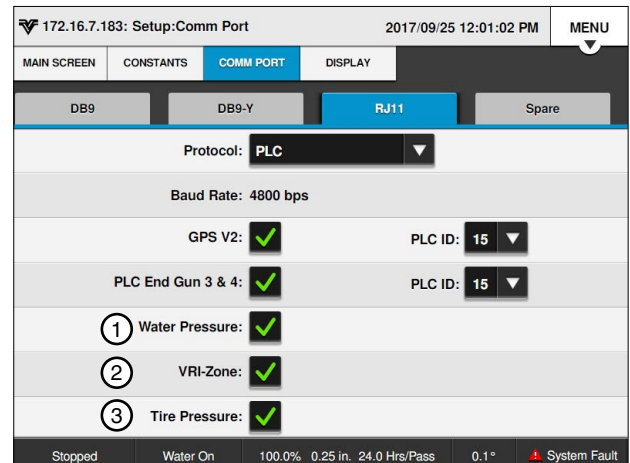

Figure 43-1 PLC Screen
 1. Water Pressure Checkbox
 2. VRI-Zone Checkbox
 3. Tire Pressure Checkbox

Setup / Comm Port

Valmont Communication Protocol (VCP)

The VCP is used to set the Protocol for use with data radios, AgSense, and BaseStation.

To set the VCP Protocol, follow steps.

1. Push **Menu**, **Setup**, **Comm Port** and **DB9** (recommended) or **DB9-Y** (requires special cabling).
2. Select the **Protocol** drop-down menu.
3. Choose **VCP**.
4. Select the **Baud Rate** drop-down menu.
5. Choose the required **Baud Rate** for the communication hardware.

Flow Control

Flow Control is used to set how the control panel communications hardware sends and receives information. The flow control factory default setting is None.

To set the Flow Control to be used by the control panel follow these steps:

1. Select the **Flow Control** drop-down menu for the Comm Port.
2. Choose the flow control type.
 - None (Default option)
 - CTS (Clear To Send)
 - DCD (Data Carrier Detect)

Set to None if hardware does not support CTS or DCD.

High Speed (High Speed Key Wait)

High Speed Key Wait is used for high speed communications hardware. High Speed is disabled as a default.

To enable the High Speed Key Wait time, check the **High Speed** checkbox. Refer to Figure 44-1.

Key Wait

Key Wait is used to set the radio key wait time before transmission of data. The Key Wait default setting is 0.0 seconds.

To set the Key Wait time follow these steps:

1. Select the **Key Wait** field for the Comm Port. Refer to Figure 44-1.
2. Using the numeric keypad, enter the Key Wait delay time in seconds.
3. Push **Enter** to retain the value.

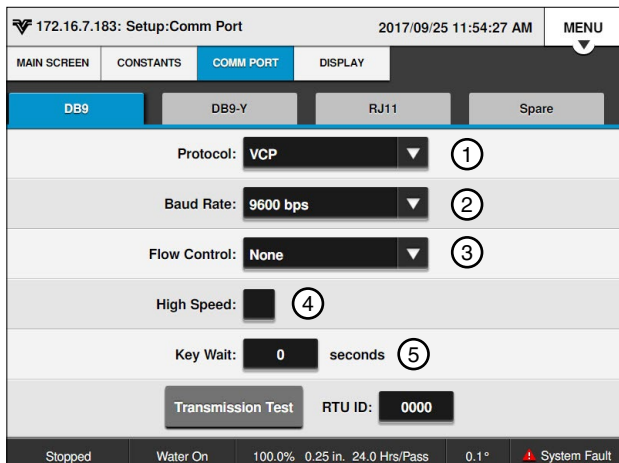

Figure 44-1 DB9 Comm Port Screen

1. VCP Protocol
2. Baud Rate Drop-Down
3. Flow Control Drop-Down
4. High Speed Checkbox
5. Key Wait

Transmission Test Button

The Transmission Test button sends a transmission test notice event message through an optional communication device, such as a radio or phone modem, to another control panel or BaseStation equipped with a similar communication device. Use the Transmission Test button to test communications after installation. There is a random 0 to 10 second delay prior to the transmission of data. Refer to Figure 45-1.

Using Transmission Test

To transmit, push **Menu, Setup, Comm Port, DB9, DB9-Y, or SPARE**, and the **Transmission Test** button.

RTU ID

The RTU ID (Remote Telemetry Unit Identity) is set only when an optional remote telemetry device is used to communicate with the control panel. The control panel RTU ID is a four-digit value with a range of 0000-FFFF that the user selects. None of the other user control panels or BaseStations can have the same RTU ID number.

- RTU ID number 0000 is the factory default setting for all RTU devices.
- RTU ID numbers 0998 and 0999 are typically reserved for use by a primary BaseStation.

Setting the RTU ID

To set the RTU ID constant follow these steps:

1. Select the **RTU ID** field. Refer to Figure 45-1.
2. Using the numeric keypad, enter the unique four-digit control module RTU ID.
3. Push **Enter** to retain the value.

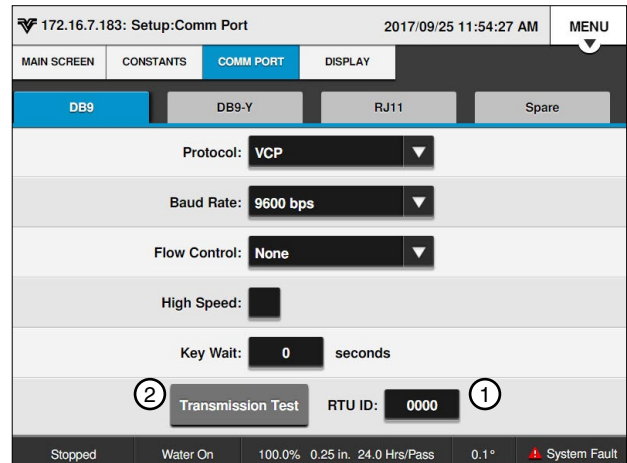

Figure 45-1 DB9 Comm Port Screen
 1. RTU ID
 2. Transmission Test

Setup / Display

Display

Display is where settings for language, units of measure, screen brightness, sleep timer, date, and times are located. Refer to ICON10 / ICON1 Owner's Manual, Part Number 0999955 (English) for information on how to access the settings in Display.

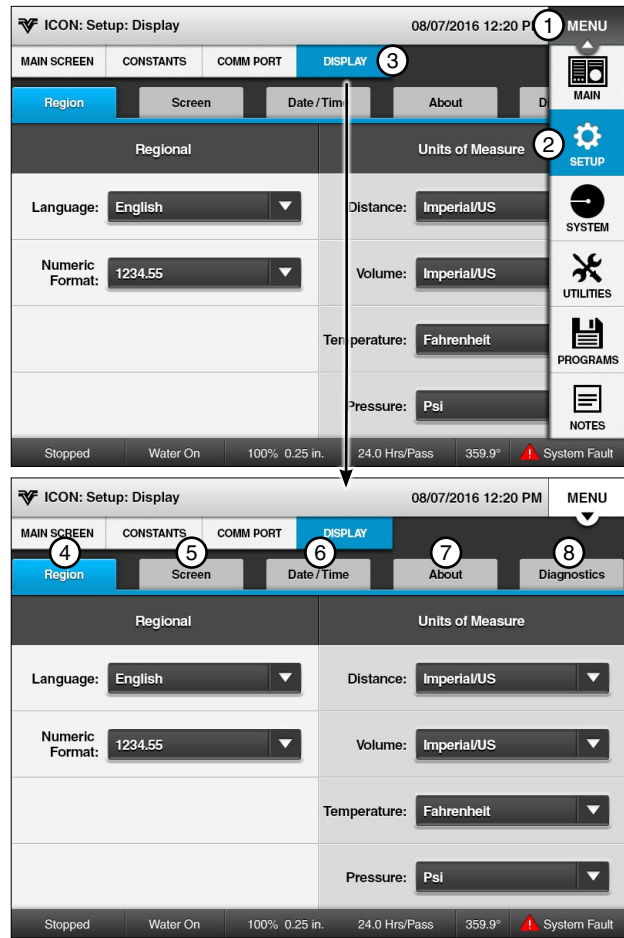

Figure 46-1 1. Menu
2. Setup
3. Display
4. Region
5. Screen
6. Date/Time
7. About
8. Diagnostics

System Menu

Push **Menu** and **System** to display the System menu. The user can change settings or view information from the System menu at any time. The following flowchart is provided to help you navigate the System menu. Refer to Figure 47-1.

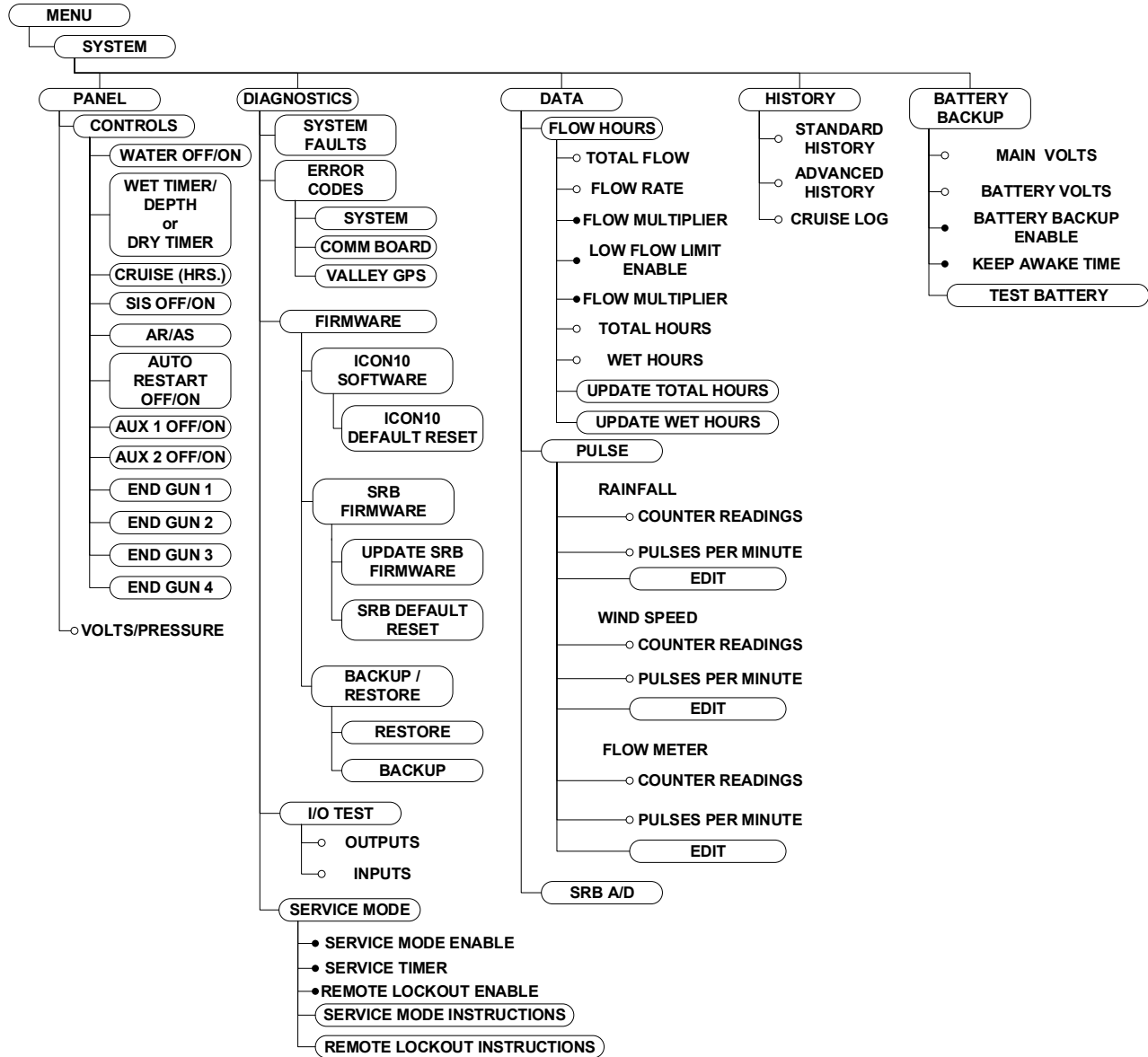

Figure 47-1

Controls

Push **Menu**, **System**, **Panel** and **Controls** to view the Controls screen. Refer to Figure 49-1.

Pushing **Controls** will display all of the control buttons, including those selected to appear on the Main screen.

Status Bar

The Status Bar runs along the bottom of the Controls screen and displays up to seven different statuses.

The statuses that are displayed are the Machine Status/Direction, Water On/Off, % Timer/Depth/Hrs/Pass, Position, and System Faults. If there is a system fault the user can press this as a button and it will navigate to Diagnostic/System Faults screen.

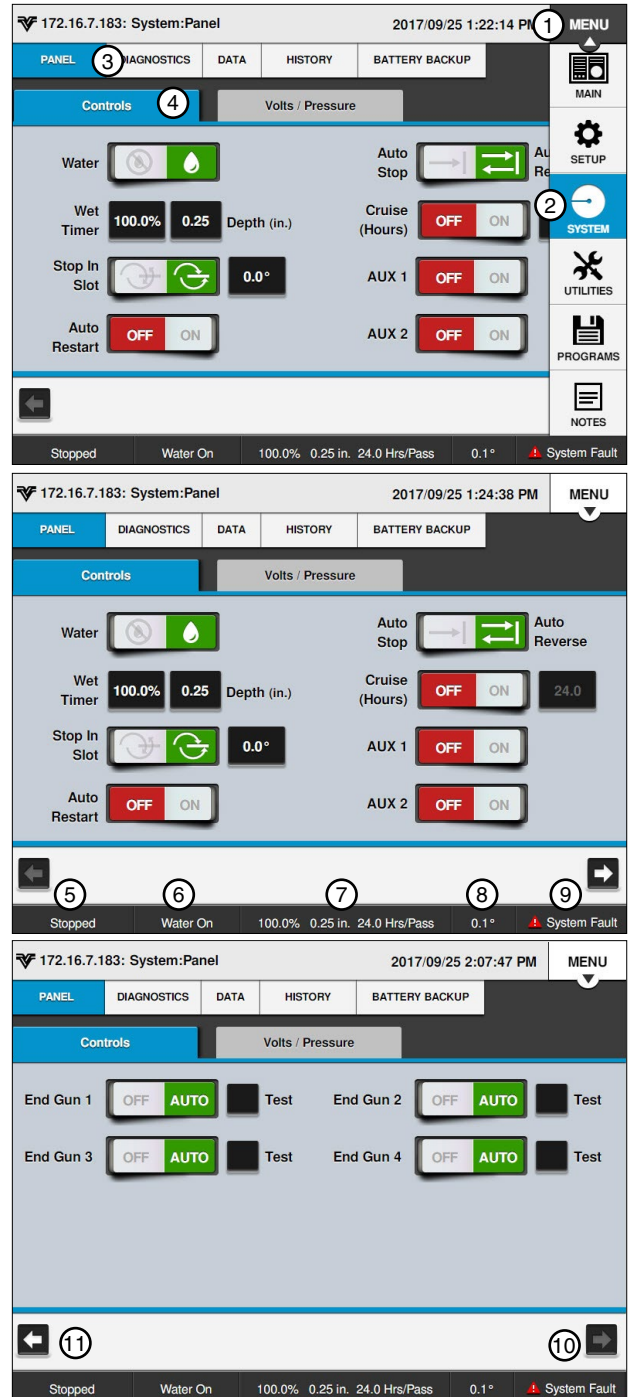

Figure 49-1

1. Menu	7. % Timer / Hrs/Pass
2. System	8. Position
3. Panel	9. System Fault
4. Controls	10. Next
5. Machine Status	11. Previous
6. Water On/Pressure	

System / Panel

Control Buttons

Up to Six control buttons can be selected to appear on the left side of the screen for operating the machine. You can access all the control buttons by pushing **Menu, System, Panel, and Controls**.

Below are descriptions of each available control button. It is very important to understand that, the control button indicates what the machine is currently doing.

Water



Water On - The pump and/or close water valve are currently on (if wired to do so). Push to turn them off.



Water Off - The pump and/or close water valve are currently off. Push to command pump to turn on, valve to open, or both, when machine starts (if wired to do so).

Pressure delay is automatically recalled to allow sufficient time for pressure to build up in the machine before it moves.

% Timer/Depth



Wet % Timer/Depth Field - When water is on, select the right side of the field for Depth and enter the water application depth by inches or millimeters, or select the left side of the field for Wet % Timer and adjust the percent to obtain the desired application depth. The percent timer indicates the percentage of a minute which the end tower runs.



Dry % Timer Field - When water is off, select the Dry % Timer field and adjust the percent to obtain the desired speed of travel. The percent timer indicates the percentage of a minute which the end tower runs.

Cruise (Hrs)



Cruise (Hrs) - On - Cruise is on. Push to turn off.



Cruise (Hrs) Off - Cruise is off. Push to turn on.



Cruise (Hrs) Field - When Cruise is on, push to set the number of hours to complete the designated field size that is set in cruise control constants.

Stop-In-Slot



Stop-In-Slot On - Stop-In-Slot is on and will stop the machine at a preset location in the field that is user selected. Push to turn Stop-In-Slot off.



Stop-In-Slot Off - Stop-In-Slot is off. Push to turn Stop-In-Slot on.



Stop-In-Slot Field - When Stop-In-Slot is on, push to set the angular location of the Stop-In-Slot.

Auto Restart



Auto Restart On - Automatic Restart is on. Push to turn off.



Auto Restart Off - Automatic Restart is off. Push to turn on.

Auxiliary 1 and 2



Aux On - The Auxiliary is on. Push to turn off.



Aux Off - The Auxiliary is off. Push to turn on.

Auto Reverse/ Auto Stop



AR/AS Disabled - Auto Reverse/Auto Stop is disabled. Push **Menu, Utilities, AR/AS, Config ARAS, Auto Reverse / Auto Stop** to enable.



Auto Reverse On - Auto Reverse is on. Push to turn Auto Stop on.



Auto Stop On - Auto Stop is on. Push to turn Auto Reverse on.

End Gun



End Gun Auto - When end gun is set to Auto the selected end gun is enabled and ready. Push to turn off (disable). Check the checkbox to test end gun operation. The test will complete when unchecked or after five minutes.



End Gun Off - The end gun is off (disabled). Push to turn auto on (enable). Check the checkbox to test end gun operation. The test will complete when unchecked or after five minutes.

Volts / Pressure

The Volts / Pressure screen is used to monitor the Voltage and Pressure for the machine. Based on the voltage calibration set up in the Constants section and the pressure sensor setup in the Constants section, under Pump & Pressure.

To monitor voltage and pressure using the Volts / Pressure screen, push **Menu**, **System**, **Panel**, and **Volts / Pressure**. Refer to Figure 51-1.

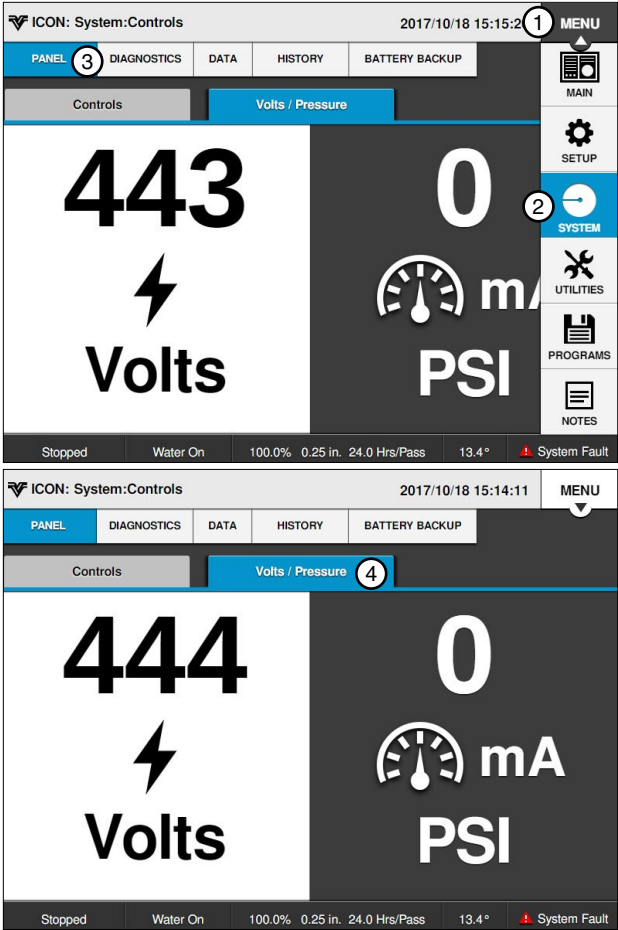

Figure 51-1 1. Menu 2. System 3. Panel 4. Volts / Pressure

System / Diagnostics

Diagnostics

The Diagnostics section provides an overview of the diagnostic features incorporated into the control panel. Diagnostics aid in identifying machine failures, troubleshooting, and correcting problems. Refer to Figure 52-1.

The following pages contain information on I/O Test and Service Mode.

For information on System Faults, Error Codes, ICON 10 Software Default, Smart Relay Board Default, Firmware Update, Backup and Restore, refer to the ICON 10 / ICON 1 Owner's Manual, Part Number 0999955 (English).

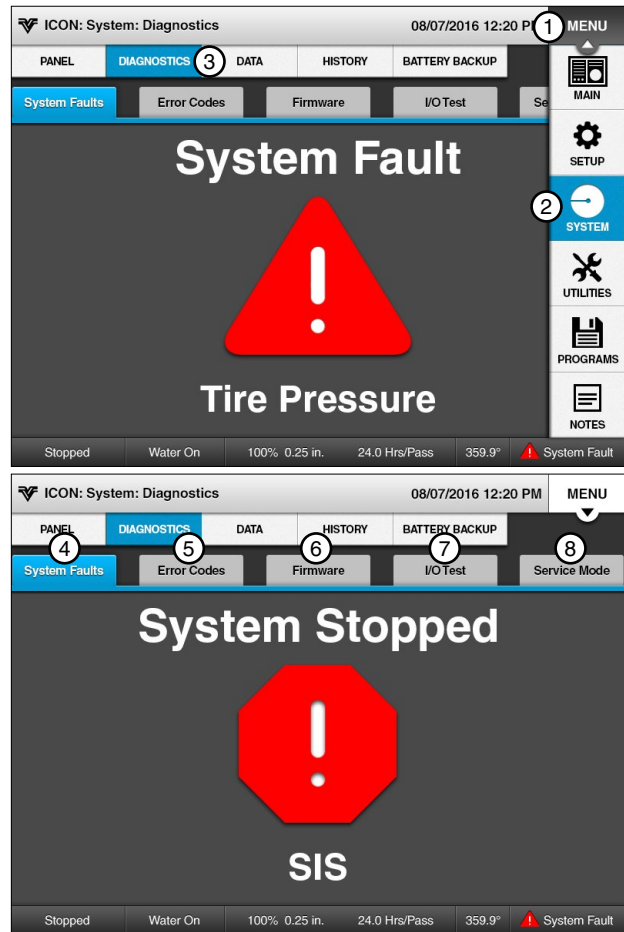

Figure 52-1

1. Menu	5. Error Codes
2. System	6. Firmware
3. Diagnostics	7. I/O Test
4. System Faults	8. Service Mode

I/O Test

I/O Test is used to view the status of the input and control the status of the output.

Outputs

The Output screen displays the current relay conditions.

When the button next to a relay description is on, the relay contacts are closed. When the button is off, the relay contacts are open.

The machine is controlled by a series of relays located in the control panel. Each the contacts in each relay are either closed (on) or open (off) as the machine is operating.

Note: Some outputs toggle faster than the display can refresh.

Reviewing Outputs

To review Outputs, do the following and refer to Figure 53-1.

1. Push **Menu**, **System**, **Diagnostics** and **I/O Test**.
2. Push **Outputs** to display the Outputs screen.
 - To move between screens use the **Next** and **Previous** buttons.
3. To test a specific output/relay, push the output button to turn it on or off.

NOTE

- Turning Display Ignition Enable OFF or 12V Output Enable will turn off the screen and require the panel to be power cycled to turn the screen back on.

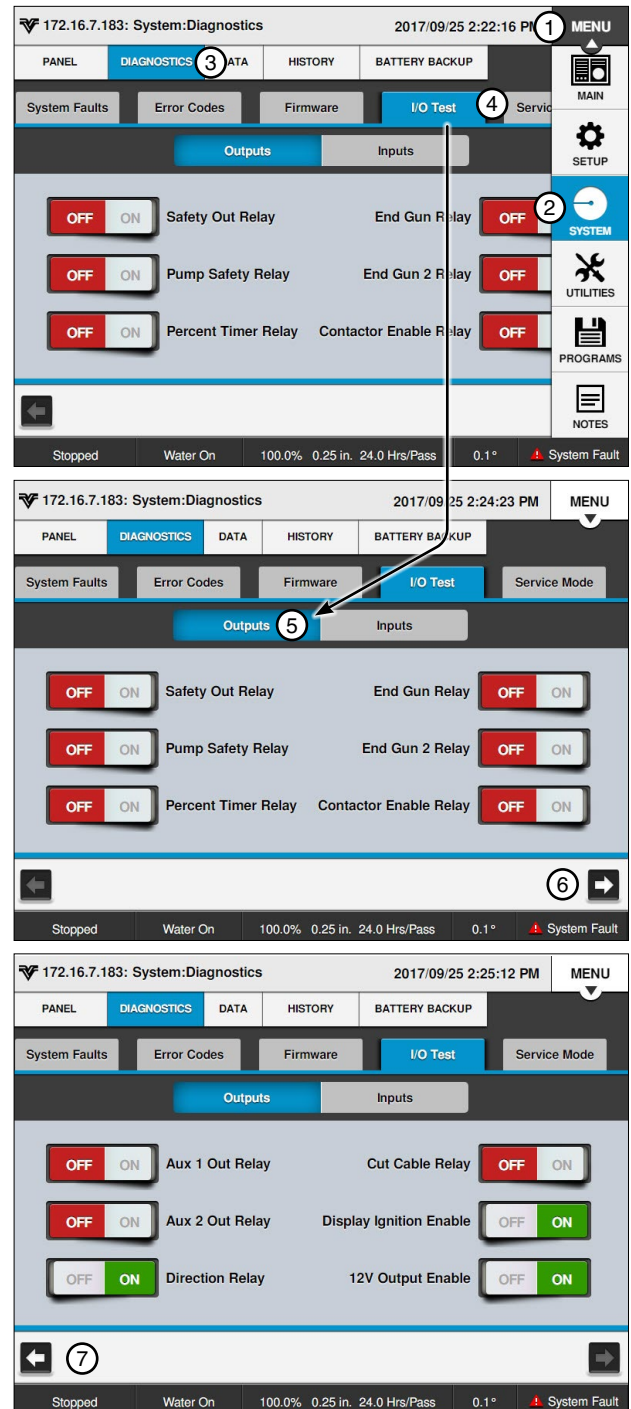

Figure 53-1

1. Menu	5. Outputs
2. System	6. Next
3. Diagnostics	7. Previous
4. I/O Test	

System / Diagnostics

I/O Test (Continued)

Inputs

The Inputs screen displays the current input statuses.

Reviewing Inputs

To review inputs, do the following and refer to Figure 54-1.

1. Push **Menu**, **System**, **Diagnostics** and **I/O Test** .
2. Push **Inputs** to display the Inputs screen.

The indicator on the screen indicates the status of each input.

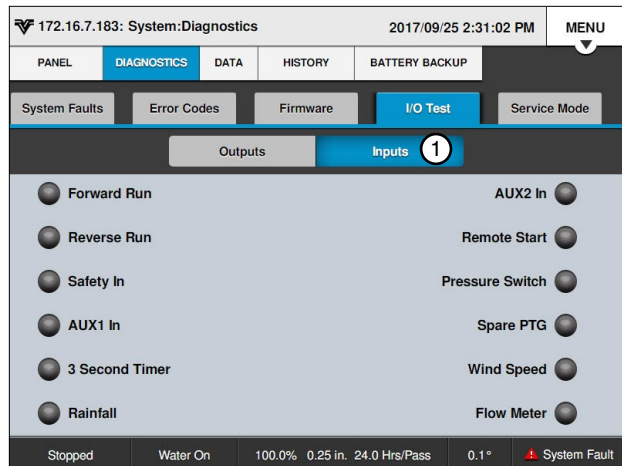

Figure 54-1 1. Inputs

Service Mode

Service Mode

Service Mode is used to help aid in the diagnostics, troubleshooting, or setup of a machine.

Enable/Disable Service Mode

To enable or disable the Service Mode follow these steps:

1. Push **Menu**, **System**, **Diagnostics**, and **Service Mode** to view the Service Mode screen. See Figure 55-1.
2. Check the **Service Mode** checkbox to enable Service Mode, and uncheck the Service Mode checkbox to disable it.
 - When Service Mode is enabled:
 - » The Safety Out line is activated.
 - » Water is turned off
 - » The Percent Timer is set to 0%.
 - » The Remote Lockout is turned on.
 - » The Service Timer is activated.
 - While in Service Mode:
 - » The Safety Out circuit remains activated.
 - » The machine mode changes to Running if safety is returned, as would be done normally.

Caution: This causes the forward or reverse contactors to engage, enabling 480VAC to be fed down the machine. There is a five second delay before contactors will engage.

 - » The user has access to all controls (Water, Percent, SIS, etc.).
 - When Service Mode is disabled:
 - » The control panel resumes normal operation at the current settings.
 - » The Remote Lockout is turned off, unless it was on prior to turning service mode on.
 - Service Mode shall be automatically disabled if:
 - » The Service Timer times out.
 - » The user turns Service Mode off through the menus.
 - » The machine is stopped with a fault condition other than the Safety fault.
 - » The user presses either the Start or Stop buttons.
3. To set the Service Timer, select the **Service Timer** field and enter the desired time in minutes. Push **Enter** to retain the value.

The service timer will turn the service mode off after the default time of 60 minutes or the user can set the service timer for 1 to 255 minutes. The service timer can be set at anytime. The service mode does not need to be enabled.

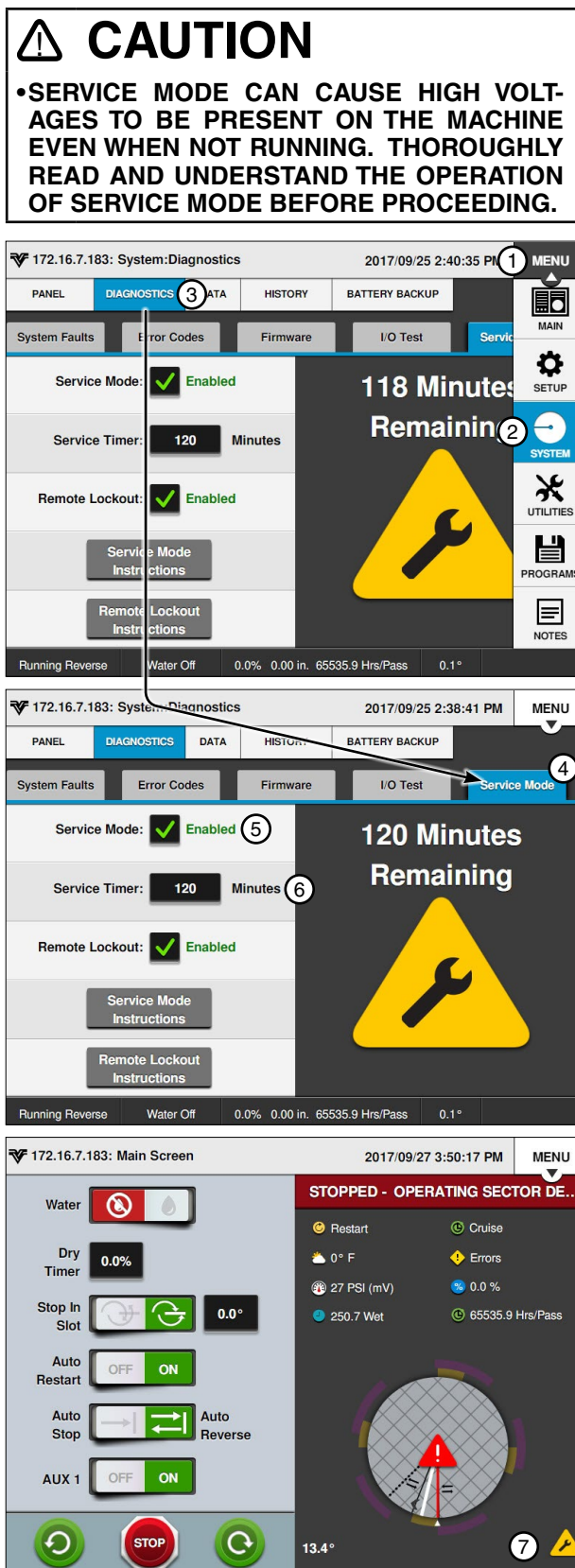

Figure 55-1 1. Menu 5. Service Mode Checkbox
 2. System 6. Service Timer
 3. Diagnostics 7. Service Mode Icon
 4. Service Mode

System / Diagnostics

Service Mode (Continued)

Remote Lockout

Remote Lockout is used to disable control through a remote communication device such as BaseStation or Agsense, and the control panel. When remote lockout is on, the control panel cannot be controlled remotely.

Enable/Disable Remote Lockout

To turn the remote lockout on or off:

1. Push **Menu**, **System**, **Diagnostics**, **Service**, and **Service Mode** to display the Service Mode screen. Refer to Figure 56-1.
2. Check the **Remote Lockout** checkbox to enable Remote Lockout, and uncheck the checkbox to disable it.

NOTE

- Remote lockout does not lock out the Wi-Fi option from controlling the panel.

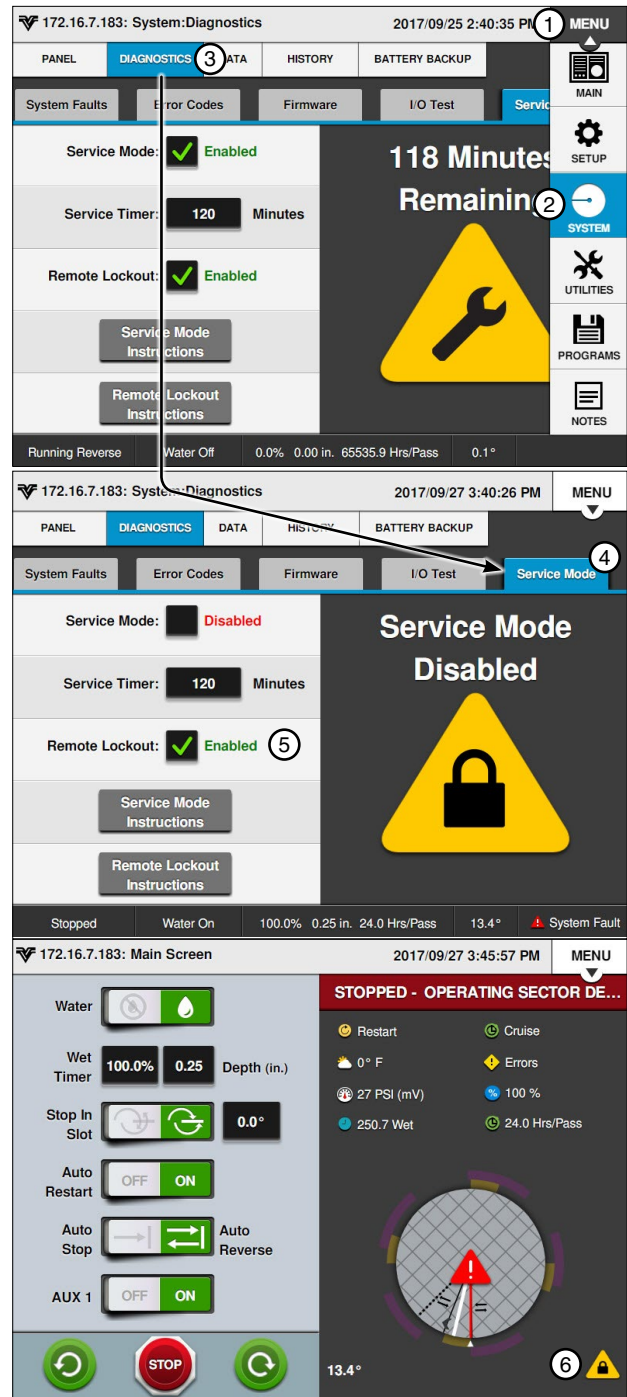

Figure 56-1 1. Menu 2. System 3. Diagnostics 4. Service Mode 5. Remote Lockout Checkbox 6. Remote Lockout Icon

Data

The Data option is used to review the machine's Flow/Hours, Pulse, and SRB A/D information collected by the control panel. Push Menu, System, and Data. Refer to Figure 57-1.

Flow/Hours

Flow/Hours is used to review and edit the machine's Flow/Hours information.

Push **Menu**, **System**, **Data**, and **Flow/Hours** to display the Flow/Hours screen. Refer to Figure 57-1.

Total Flow

The Total Flow volume and Flow Rate are displayed when the flow meter option is installed. Total Flow is displayed in millions of gallons, or cubic meters.

Flow Rate

The Flow Rate is displayed in either gallons per minute (GPM) or liters per minute (LPM), depending on the unit of measurement.

Flow Multiplier

The Flow Multiplier calibrates the control panel with the optional flow meter. Flow Multiplier constants (pulse multiplier values) are usually provided by the flow meter manufacturer. The table below lists multiplier values for Valmont-supplied flow meters.

Setting the Flow Multiplier

To set Flow Multiplier follow these steps:

1. Select the **Flow Multiplier** field. Refer to Figure 57-1.
2. Using the numeric keypad, enter the manufacturer's recommended pulse multiplier value in either gallons per pulse or liters per pulse, depending on the unit of measure.
3. Push **Enter** to retain the value.

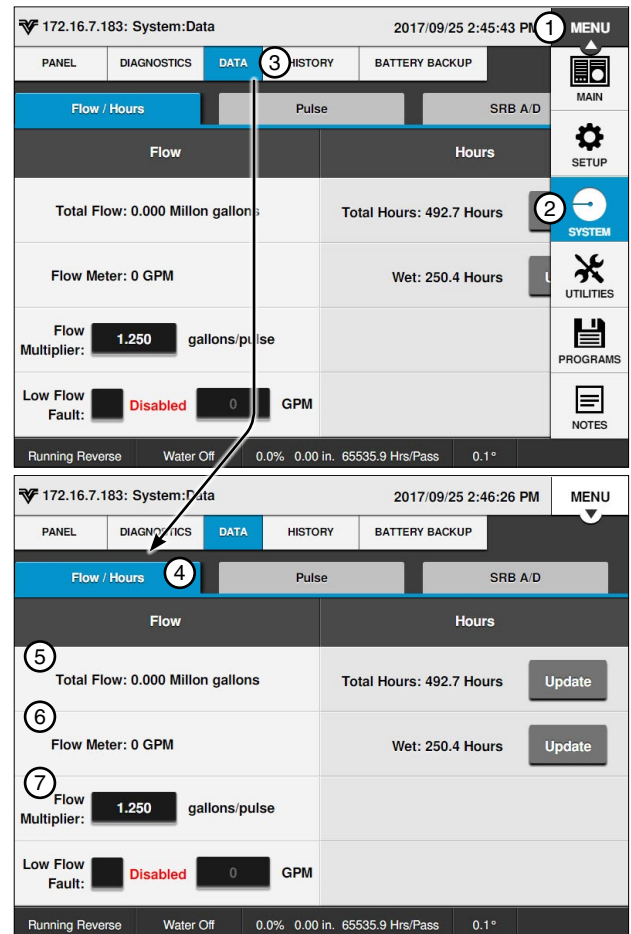

Figure 57-1 1. Menu 5. Total Flow
2. System 6. Flow Rate
3. Data 7. Flow Multiplier
4. Flow/Hours

Pipe Diameter (inches)	Gallons per Pulse Typical Values	Liters per Pulse	Max. GPM/RPM	Max. LPS/RPM
6	0.6250	2.366	1300/2080	82.02/2080
6-5/8	0.7407	2.804	1300/1755	82.02/1755
8	1.2500	4.732	2500/2000	157.72/2000
8-5/8	1.3514	5.116	2500/1850	157.82/1850
10	1.9231	7.280	3000/1560	189.27/1560

The above chart reflects McCrometer Flowmeter information.

System / Data

Flow/Hours (Continued)

Low Flow Limit

Low Flow Limit is used to monitor the flow rate, and requires the use of an optional flow meter.

A Low Flow error is recorded if the flow rate reaches the minimum flow rate setting while the system is above the low pressure setting.

If the flow rate remains at or below the low flow rate setting for 15 seconds, the machine is shut down and a Low Flow system fault is recorded.

A Low Flow system fault can only occur if the system is above the low pressure setting, the Low Flow Limit feature is on, and a flow meter is installed. Refer to Figure 58-1.

1. To enable the Low Flow Limit, select the **Low Flow Limit** field to open the numeric keypad.
2. Enter a value into the numeric keypad and push **Enter** to retain the value.

Note: The Low Flow Limit will automatically be enabled when a valid number is entered into the keypad, this will be indicated when the Low Flow Limit checkbox becomes checked. A value of 0 disables the Low Flow Limit.

Total Hours

Total Hours displays the cumulative hours of both wet and dry operation. Total Hours can be changed by the operator, but only an increase in total hours is accepted.

Wet Hours

Wet Hours displays only the hours that the machine was operated with water, or wet. Wet Hours can be changed by the operator. An increase or decrease is accepted.

Setting Total Hours or Wet Hours

To set **Total Hours** or **Wet Hours** follow these steps:

1. Push **Menu, System, Data,** and **Flow/Hours** to display the Flow/Hours screen. Refer to Figure 58-1.
2. Push the **Update Total Hours** button or **Update Wet Hours** button for the Total Hours or Wet Hours screen.
3. Enter the number of hours on the numeric keypad.
 - Total Hours can only be increased. Decimal values are not allowed.
 - Hours Wet can be increased or decreased. Decimal values are not allowed.
4. Push **Enter** to retain the value.

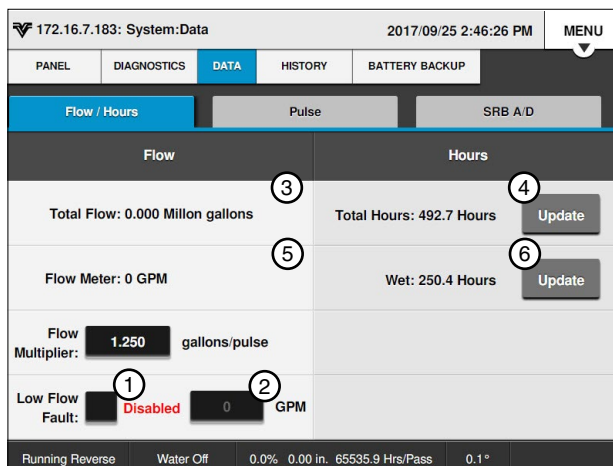

Figure 58-1 1. Low Flow Limit Checkbox 2. Low Flow Limit 3. Total Hours Status 4. Update Total Hours 5. Wet Hours 6. Update Wet Hours

Pulse

Pulse is used to review pulse counts from external equipment. There are three Pulse Counters: Rain, Wind, and Flow. Refer to Figure 59-1.

- Rain is reserved for the Rain Measurement indicator option. The rain measurement pulses are provided by a tipping rain bucket.
 - » Counter Reading, for Rain, counts and totals the electrical pulses from the tipping bucket. This value is converted to inches and displayed on the Current Weather screen.
 - » Pulses Per Minute, for Rain, provides the rate of pulses from the tipping bucket in pulses per minute. This value is converted to inches, or millimeters, and is displayed with the rain icon on the Current Weather and Status screens. It can also be displayed on the Main screen status.

- Wind is reserved for the Wind Speed indicator option. The wind speed pulses are provided by an anemometer. Two pulses are recorded for each turn of the anemometer.
 - » Counter Reading for Wind counts and totals the electrical pulses from the anemometer.
 - » Pulses Per Minute for Wind provides the rate of pulses from the anemometer in pulses per minute. This value is converted to miles per hour, or kilometers per hour, and is displayed with the wind icon on the Current Weather and Status screens. It can also be displayed on the Main screen status.

- Flow is reserved for the Flow Meter option. The flow meter propeller produces a certain number of electrical pulses per gallon, or liter. Example: 1.250 pulses per gallon.
 - » Counter Reading for Flow counts and totals the electrical pulses from the flow meter.
 - » Pulses Per Minute for Flow provides the rate of pulses from the flow meter in pulses per minute. This value is converted to gallons per minute, or liters per second, and is displayed as Flow Meter on the Flow/Hours screen.

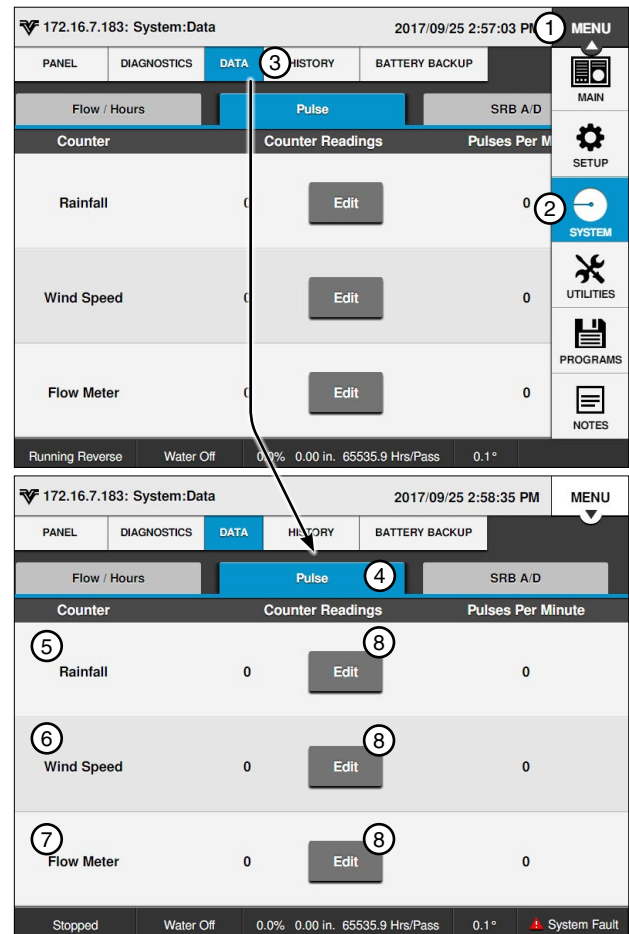

Figure 59-1

1. Menu	5. Rainfall
2. System	6. Wind Speed
3. Data	7. Flow Meter
4. Pulse	8. Edit

Edit Counter Readings

To edit counter readings follow these steps:

1. Push **Menu**, **System**, **Data**, and **Pulse** to display the Pulse screen. Refer to Figure 59-1.
2. Push the **Edit** button for the Counter value that will be edited.
3. Enter a value using the numeric keypad.
4. Push **Enter** to retain the value.

System / Data

SRB A/D

Smart Relay Board Analog to Digital Voltages (SRB A/D) is used to review analog voltage inputs. There are 15 analog channels to monitor voltage feedback. The normal range for each voltage measurement is indicated by orange hash marks along one side of the volt meter. The meters are color coded. Green is displayed when voltage is within the voltage range. Red is displayed when voltage is outside the voltage range. Refer to Figure 60-1.

- Voltage Pressure monitors the voltage from the (mV) pressure sensor. This voltage varies as pressure increases and decreases, and it is converted into a pressure reading in either pounds per square inch (PSI) or kilopascals (kPa). This voltage varies between approximately 1000 mV [0 psi. (0 kPa)] and 4000 mV [200 PSI (1387 kPa)].
- 5 VDC Sensor Power displays voltage available to the (mV) Pressure sensor. The voltage should always be around 5 VDC.
- 4-20 mA Pressure monitors current from the (mA) pressure sensor. This current varies as pressure increases and decreases, and it is converted into a pressure reading in either pounds per square inch (PSI) or kilopascals (kPa). This current varies between approximately 4 mA and 20 mA.
- 12 VDC Sensor Power displays the voltage available to the (mA) Pressure sensor and other inputs such as rain, wind, and temperature. The voltage should always be around 12 VDC.
- 480 VAC monitors machine voltage. This value varies as the voltage to the machine varies from the power source.
- 12 VDC Main Supply monitors voltage from the 12 VDC power supply.
- 3.3 VDC Internal Power monitors output of the SRB 3.3 VDC regulator.
- 12 VDC Battery Supply monitors voltage from the optional 12 VDC battery.
- 5 VDC Internal Power monitors output of the SRB 5 VDC regulator.
- 12 VDC Power Out monitors voltage from the 12 VDC power supply.
- 12 VDC Internal Power monitors output of the SRB 12 VDC regulator.
- 12 VDC Expansion Card monitors voltage from the optional 12 VDC power supply expansion card.
- Temperature monitors voltage from the temperature sensor. This value varies, as the temperature increases and decreases.
- Aux Monitor monitors voltage from an optional auxiliary device.
- Wind Direction monitors voltage from the wind direction sensor. This value varies, as the temperature increases and decreases.

Reviewing A/D

To review analog voltages follow these steps:

1. Push **Menu**, **System**, **Data**, and **SRB A/D** to display the Data screen.

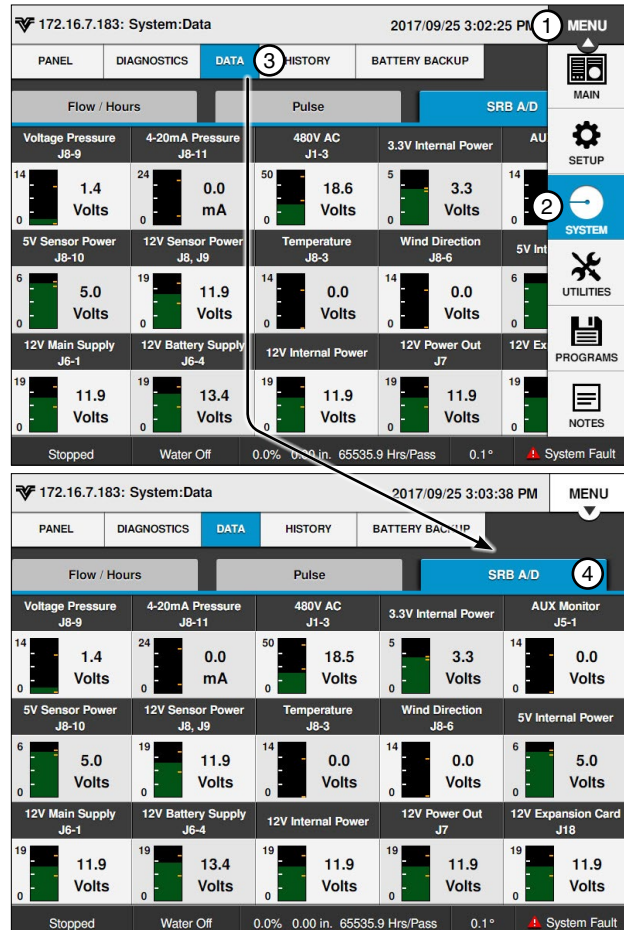

Figure 60-1 1. Menu
2. System
3. Data
4. SRB A/D

History

History provides a record of the 50 most recent machine operation status changes. For information on viewing Standard History, Advanced History, or the Cruise Log refer to ICON10 / ICON1 Owner's Manual, Part Number 0999955 (English).

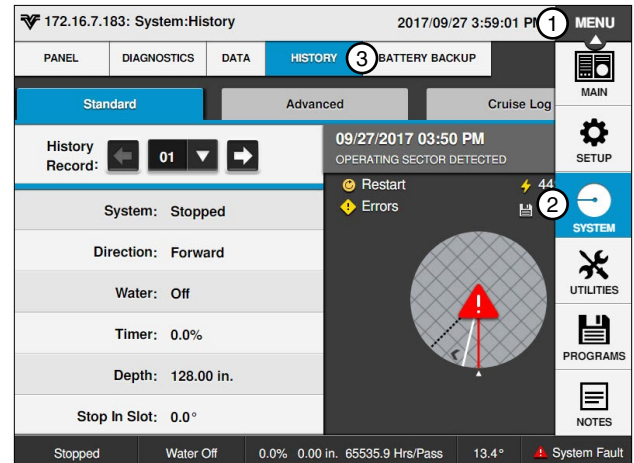

Figure 61-1 1. Menu
2. System
3. History

System / Battery Backup

Battery Backup Option

The Battery Backup screen provides the ability to keep the ICON, SRB, and telemetry awake for a set amount of time while the fault is sent to BaseStation. The Battery Backup screen also monitors the voltage from the main power source and the battery. The normal range of each voltage measurement is indicated by orange marks along one side of the volt meter. Battery Backup requires additional hardware. Refer to Figure 62-1.

Enable Battery Backup

To enable Battery Backup follow these steps:

1. Push **Menu**, **System**, and **Battery Backup** to display the Battery Backup screen.
2. Check the **Battery Backup** checkbox.

Test Battery

To test the backup battery push the **Test Battery** switch to on.

If the machine does not have a backup battery the control panel will restart.

Set Keep Awake Time

To set the Keep Awake Timer for the amount of time Battery Backup will keep the ICON, SRB, and telemetry awake after a power loss follow these steps:

1. Push **Menu**, **System**, and **Battery Backup** to display the Battery Backup screen. Refer to Figure 62-1.
2. Select the **Keep Awake Time** field and enter a value from 0 to 255 using the numeric keypad.
3. Push **Enter** to retain the value.

NOTE

- A setting value of 0 will run off the backup battery until it is depleted.

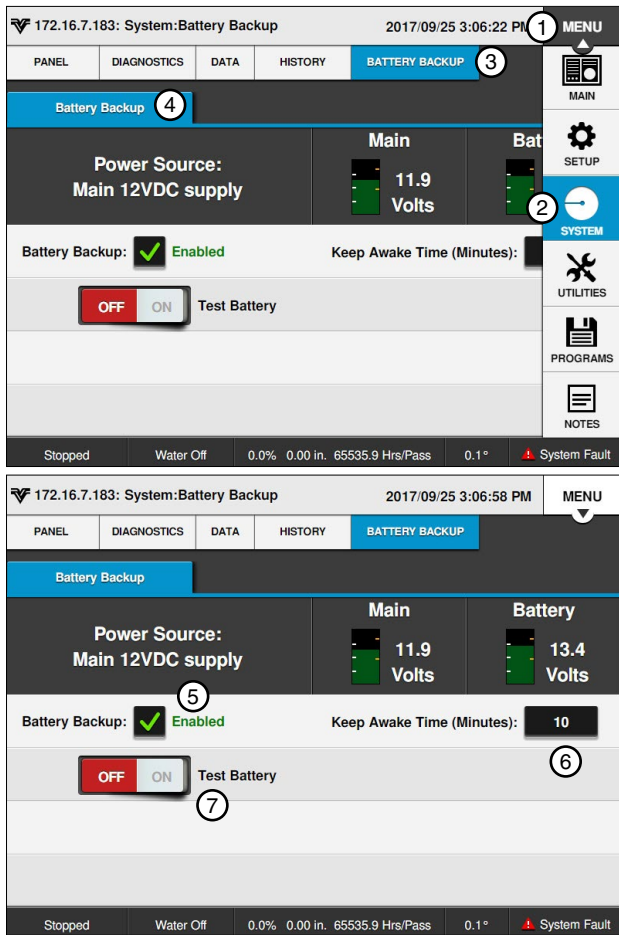

Figure 62-1 1. Menu 5. Battery Backup Checkbox
2. System 6. Keep Awake Time (Minutes)
3. Battery Backup 7. Test Battery
4. Battery Backup

Utilities Menu

Push **Menu** and **Utilities** to display the Utilities menu. The user can change settings or view information from the Utilities menu at any time. The following flowchart is provided to help you navigate the Utilities menu. Refer to Figure 63-1.

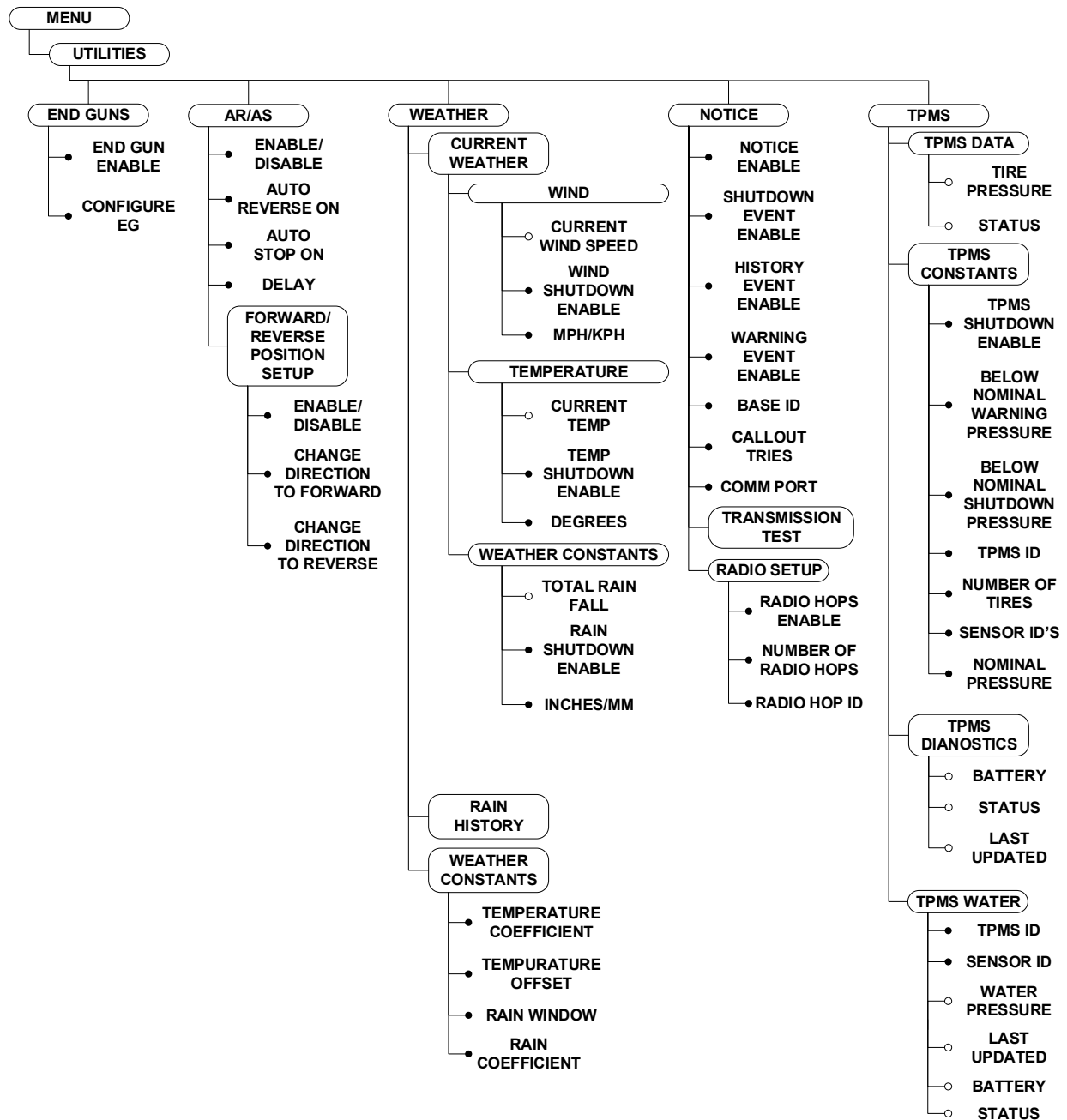

Figure 63-1

End Guns

The End Guns screen is used to enable, disable, and set End Gun Sequences.

Push **Menu**, **Utilities and End Guns** and use the End Gun checkboxes to enable or disable End Guns. Refer to Figure 65-1.

End Guns 3 and 4

End Guns 3 and 4 can be used to control a corner machine sprinkler sequence, a second end gun, a span of sprinklers, or other electrically controlled devices with a voltage of 120 VAC that does not exceed a continuous load current of 1 amp maximum.

NOTE

- End Guns 3 and 4 are only available when PLC End Guns 3 and 4 is enabled in Setup/Comm Port/Protocol/PLC/PLC Setup screen. It can also be enabled with Valley GPS.
- To use End Guns 3 and 4, the machine must be equipped with a Wide Boundary tower box.
- The desired Wide Boundary must be enabled on the End Gun screen.
- Also available when using Valley GPS protocol and EG3&4 are selected as an option.

End Gun Display

The Main Screen Controls can be customized to include End Gun switches. The End Gun switch allows End Gun to be enabled (auto) or disabled (off) for the Main screen. See Figure 65-2.

Enabled State: For each End Gun a different colored line is shown indicating the angle range. The enabled state is visible when the pivot position is outside the angle range. The End Gun must be enabled and the angles must be set. The color of the device will vary.

- EG1 - ● yellow indicates EG1 is enabled
- EG2 - ● purple indicates EG2 is enabled
- EG3 - ● gray indicates EG3 is enabled
- EG4 - ● red indicates EG4 is enabled

Active State: For each End Gun that is on, a blue line is shown indicating the angle range. The active state is visible when the machine is running and the pivot position is in the angle range. The End Gun must be enabled and the angles must be set. The color of the device will vary.

- EG1 - ● indicates EG1 is on
- EG2 - ● indicates EG2 is on
- EG3 - ● indicates EG3 is on
- EG4 - ● indicates EG4 is on

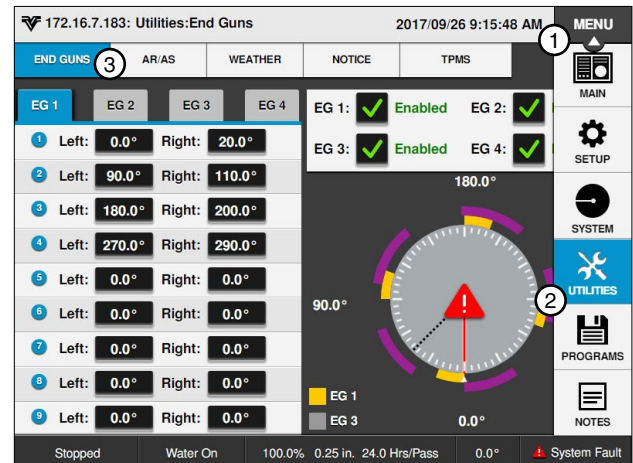

Figure 65-1 1. Menu 2. Utilities 3. End Guns

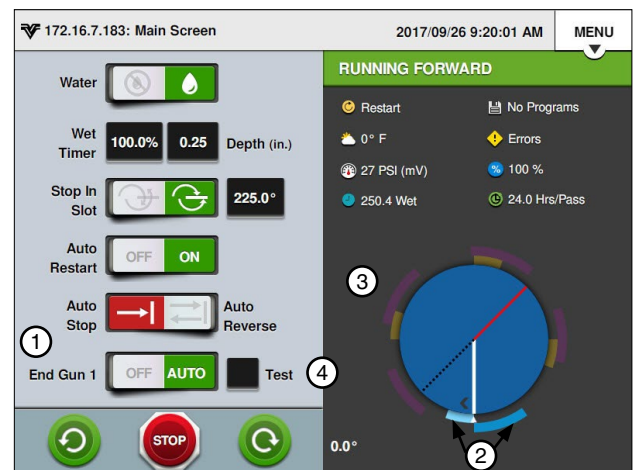

Figure 65-2 End Gun Display 1. End Gun Control 2. Enabled State 3. Active State 4. End Gun Test

NOTE

- The test checkbox allows the user to test end gun operation. The test will complete when unchecked or after five minutes.

Utilities / End Guns

End Gun Sequence Pairs

A pivot can have up to 9 End Gun Sequence Pairs, numbered 1 through 9. Each sequence consists of a left angle and a right angle. The wedge between the left and right angle is where the End Gun turns on.

The End Gun Sequence number does not affect when the End Gun turns on or off. The End Gun turns on or off based on the left angle and right angle entries.

End Gun Sequences operate the same in the forward or reverse direction.

- In the Forward direction, the End Gun turns on at the left angle and off at the right angle.
- In the Reverse direction, the End Gun turns on at the right angle and off at the left angle.

Angles can be entered in tenths to fine tune the End Gun settings.

For example, an angle can be input as 300.6°.

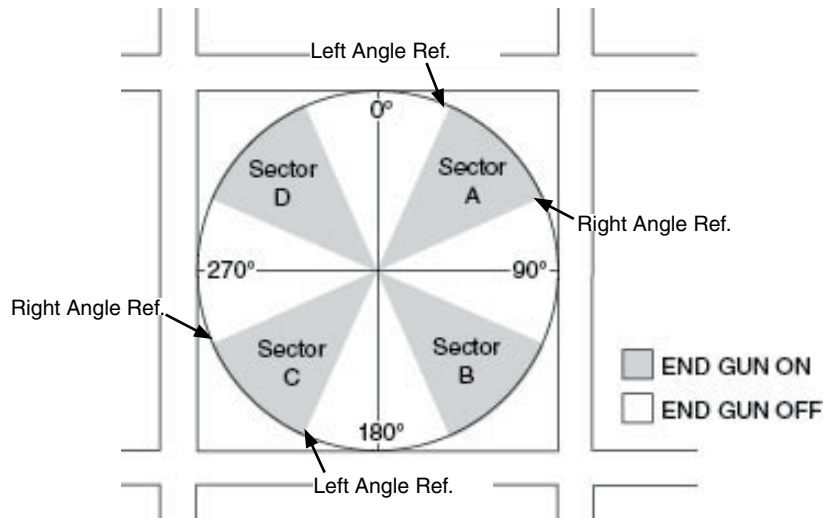

Figure 66-1

Listed below are typical end gun settings for a pivot, based on the field size and end gun being used. Note that the pivot sectors are based on the location of 0° in relation to the pivot. Refer to Figure 66-1 and the End Gun Settings table below it.

NOTE

•These End Gun settings are approximate, and vary for different fields.

NUMBER OF ACRES	END GUN	SECTOR A		SECTOR B		SECTOR C		SECTOR D	
		LEFT ANGLE	RIGHT ANGLE	LEFT ANGLE	RIGHT ANGLE	LEFT ANGLE	RIGHT ANGLE	LEFT ANGLE	RIGHT ANGLE
40	NELSON 100	31	59	121	149	211	239	301	329
40	RAINBIRD 85	27	63	117	153	207	243	297	333
160	NELSON 100	21	69	111	159	201	249	291	339
160	RAINBIRD 85	18	72	108	162	198	252	288	342
640	NELSON 100	16	74	106	164	196	254	286	344
640	RAINBIRD 85	13	77	103	167	193	257	283	347

Configure End Guns

To configure End Guns, follow these steps:

1. Push **Menu**, **Utilities** and **End Guns** to display the End Guns screen. Refer to Figure 67-1.
2. Push the **Configure EG 1** button to display the EG 1 screen.
3. To configure the first sequence pair, select the Pair 1 **Left Angle** field.
4. Using the numeric keypad, enter the left angle.
5. Push **Enter** to retain the value.
6. Select the Pair 1 **Right Angle** field.
7. Using the numeric keypad, enter the right angle.
8. Push **Enter** to retain the value.
9. Repeat steps 3 through 8 for the rest of the Pairs/Sequences.

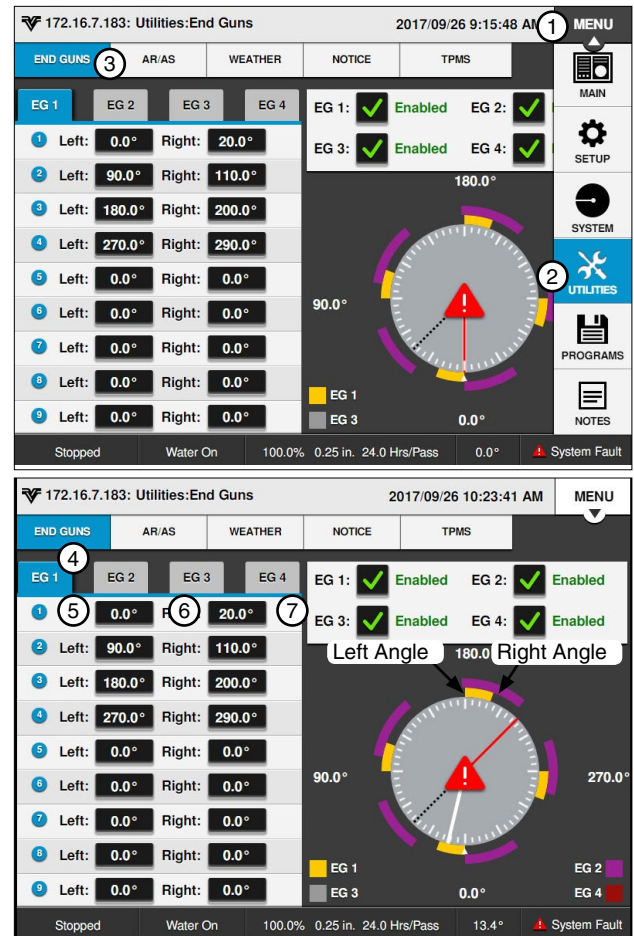

Figure 67-1 1. Menu
2. Utilities
3. End Guns
4. EG1
5. Sequence Pair
6. Left Angle
7. Right Angle

Utilities / AR/AS

Auto Reverse Auto Stop (AR/AS)

Auto Reverse Auto Stop (AR/AS) is used to enable Auto Reverse/Auto Stop, set the delay time when a machine is equipped with a drive-unit-mounted end-of-field stop/auto reverse, and to set points at which the machine will switch directions. Refer to Figure 68-1.

The AR/AS screen provides the ability to enable the Auto Reverse/Auto Stop feature and to set the delay time for Auto Reverse or Auto Stop. The Auto Reverse/Auto Stop default setting is off. The AR/AS delay time default setting is 0 seconds.

- **Auto Reverse;** If AR/AS is on and the Auto Reverse/Auto Stop option is set to Auto Reverse, when the actuator arm is tripped or when the forward/reverse boundary is reached the machine changes direction, disables the percent timer, waits for the set AR/AS delay time, and then enables the percent timer and continues running. Refer to Figure to Figure 68-1.
- **Auto Stop;** If AR/AS is on and the Auto Reverse/Auto Stop option is set to Auto Stop, when the actuator arm is tripped or when the forward/reverse boundary is reached the machine changes directions, disables the percent timer, waits for the set AR/AS delay time, and then shuts down. Refer to Figure 68-1.
- **AR/AS delay** only occurs when AR/AS is on, Water is on, and an AR/AS event has occurred.
- If AR/AS is off, the machine shuts down when the actuator arm is tripped.

⚠ CAUTION

•WHEN A MACHINE MUST REVERSE AROUND AN OBSTACLE, A DRIVE-UNIT-MOUNTED END-OF-FIELD AUTO STOP/AUTO REVERSE MUST BE INSTALLED, WITH PHYSICAL BARRIERS AS A SAFETY BACK-UP.

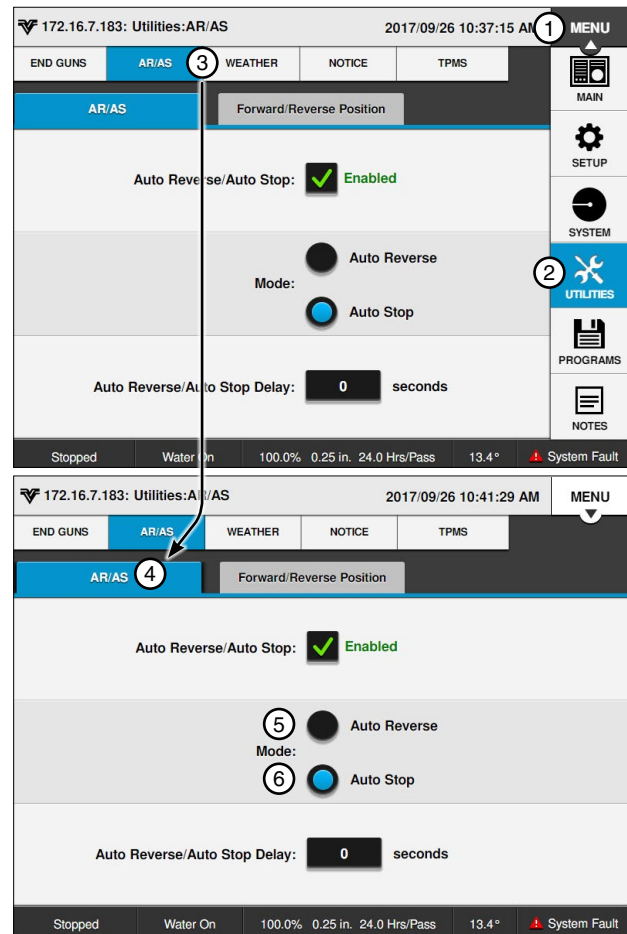

Figure 68-1 1. Menu
2. Utilities
3. AR/AS
4. Auto Reverse Disabled
5. Auto Stop Enabled

Auto Reverse Auto Stop (AR/AS) (Continued)

Enable/Disable AR/AS

To enable or disable the AR/AS option follow these steps:

1. Push **Menu**, **Utilities**, and **AR/AS** to display the AR/AS screen. Refer to Figure 69-1.
2. Check the **Auto Reverse/Auto Stop** checkbox to enable AR/AS or uncheck the Auto Reverse/Auto Stop checkbox to disable AR/AS.
3. To set AR/AS to Auto Reverse, push the **Auto Reverse** button.
4. To set AR/AS to Auto Stop, push the **Auto Stop** button.

NOTE

•AR/AS can also be set to Auto Reverse or Auto Stop on the Main screen when AR/AS is enabled.

5. To set the AR/AS Delay,
 - a. Select the **Delay (seconds)** field.
 - b. Using the numeric keypad, enter the AR/AS Delay time in seconds.
 - c. Push **Enter** to retain the value.

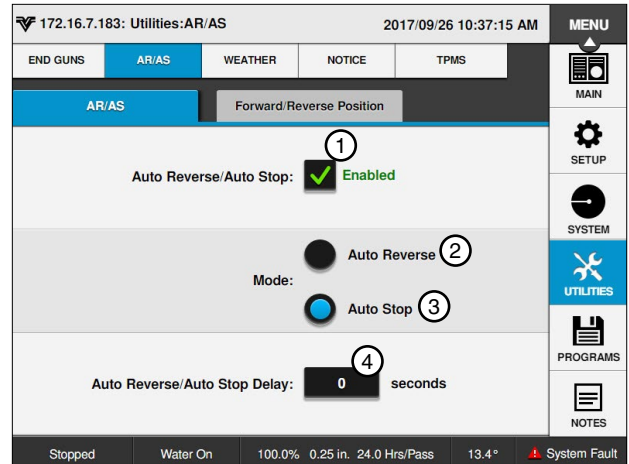

Figure 69-1 1. AR/AS Enabled 2. Auto Reverse 3. Auto Stop 4. Auto Reverse Delay

Auto Reverse Auto Stop (AR/AS) (Continued)

Forward/Reverse Position Setup

The Forward/Reverse Position Setup screen provides the ability to enable the Forward/Reverse Position option and to set the point at which the machine changes directions.

NOTE

- AR/AS must be enabled for Forward/Reverse Position to function.

Enable Forward/Reverse Position

To enable the Forward/Reverse Position option follow these steps:

1. Push **Menu**, **Utilities**, and **AR/AS** and push the **Forward/Reverse Position Setup** button to display the Forward/Reverse Position Setup screen. Refer to Figure 70-2.
2. Check the **Forward/Reverse Position** checkbox.
3. To set the point at which the machine will change its direction to forward.
 - a) Select the **Change Direction to Forward** field and enter a value using the numeric keypad.
 - b) Push **Enter** to retain the value.
4. To set the point at which the machine will change its direction to reverse.
 - a) Select the **Change Direction to Reverse** field and enter a value using the numeric keypad.
 - b) Push **Enter** to retain the value.

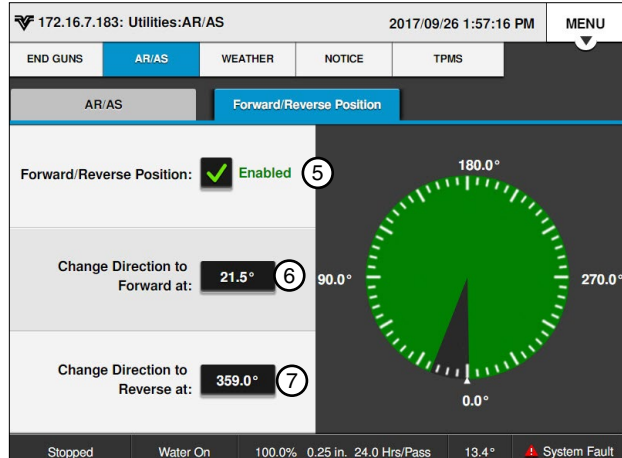
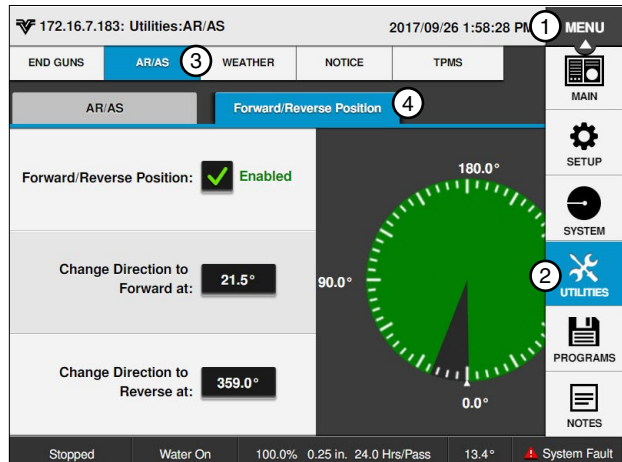

Figure 70-2

1. Menu	5. Forward/Reverse Position Checkbox
2. Utilities	6. Change Direction to Forward
3. AR/AS	7. Change Direction to Reverse
4. Forward/Reverse Position	

Weather

The Weather tab provides the options to display wind speed, temperature, and rain data, and to view or change the temperature and rain constants.

To view the Weather menu, push **Menu**, **Utilities**, and **Weather**. Refer to Figure 71-1.

Current Weather

The Current Weather screen is used to display wind speed, temperature, and rain data, and to enable/disable the wind, temperature, and rain shutdown options. Refer to Figure 71-1.

Wind Speed

The wind speed is displayed in miles per hour, or meters per second, depending on the selected unit of measure. Refer to Figure 71-1.

1. Push **Menu**, **Utilities**, **Weather**, and **Current Weather** to display the Current Weather screen.
 - The current wind speed can also be added to the Main screen status. Refer to the Setup section of this manual.

Wind Shutdown

Wind Shutdown is used to turn the high wind limit shutdown on or off, and to set the high wind speed limit. When the high wind limit shutdown is on, and the high wind limit is reached, the machine stops and a Wind fault is logged in the system. Refer to Figure 71-1.

Enabling Wind Shutdown

Check the **Wind Shutdown** checkbox to enable the wind shutdown function, and uncheck the checkbox to disable the wind shutdown function. Refer to Figure 71-1.

Setting High Wind Shutdown Limit

To set the high wind limit follow these steps:

1. Select the **Wind Speed Limit** field.
2. Using the numeric keypad, enter the high wind speed limit. The default setting is 15 miles per hour (6.7 meters per second).
3. Push **Enter** to retain the value.

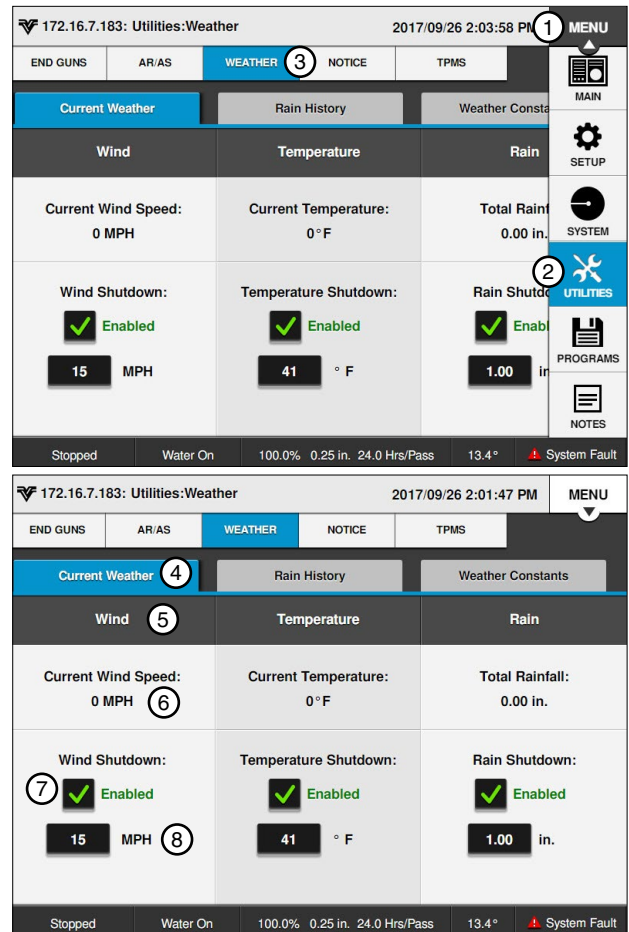

Figure 71-1

1. Menu	5. Wind
2. Utilities	6. Current Wind Speed
3. Weather	7. Wind Shutdown Checkbox
4. Current Weather	8. Wind Speed Limit

Utilities / Weather

Temperature

The temperature is displayed as + or - degrees Fahrenheit (F) or Celsius (C), depending on the selected unit of measure.

1. Push **Menu, Utilities, Weather, and Current Weather** to display the Current Weather screen. Refer to Figure 72-1.
2. View the current temperature reading at the top of the Current Weather screen or on the Status screen by pushing **Menu, Setup, Main Screen and Status**.
 - The current temperature reading can also be added to the Main screen status. Refer to the Setup section of this manual.

Temperature Shutdown

The Temperature Shutdown function is used to turn the low temperature limit shutdown on or off and set the temperature limit. If the temperature shutdown function is on, and the temperature goes below the temperature limit, the machine stops and a Temperature fault is logged in the system. The temperature shutdown limit default value is 41°F (5°C). The minimum value is 14°F (-10°C), and the maximum value is 176°F (80°C).

Temperature Shutdown

Enabling Temperature Shutdown

Check the **Temperature Shutdown** checkbox to enable the temperature shutdown function, and uncheck the checkbox to disable temperature shutdown function. Refer to Figure 72-1.

Setting Low Temperature Shutdown Limit

To set the low temperature limit follow these steps:

1. Select the **Shutdown Temperature Limit** field.
2. Using the numeric keypad, enter the low temperature limit.
3. Push **Enter** to retain the value.

NOTE

•When irrigating at low temperatures, icing or severe structural damage may occur.

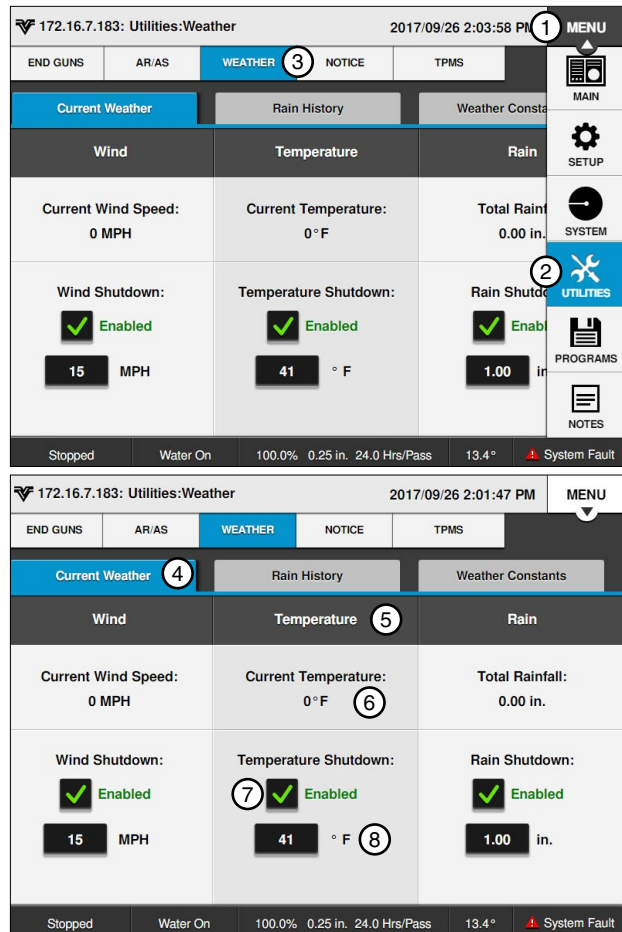

Figure 72-1

1. Menu	5. Temperature
2. Utilities	6. Current Temperature
3. Weather	7. Temperature Shutdown
4. Current Weather	Checkbox
	8. Shutdown Temperature

Rain Measurement

The Rain function allows the user to view the current rainfall amount, and to set the amount of rainfall above which the irrigation system is shut down.

The rain measurement is displayed in inches or millimeters, depending on the selected unit of measure.

1. Push **Menu**, **Utilities**, **Weather**, and **Current Weather** to display the Current Weather screen. Refer to Figure 73-1.
2. View the current rainfall amount at the top of the Current Weather screen or on the Status screen by pushing **Menu**, **Setup**, **Main Screen**, and **Status**.
 - The current rainfall amount can also be added to the Main screen status. Refer to the Setup section of this manual.

Rain Shutdown

The Rain Shutdown function allows the user to set the amount of rainfall above which the irrigation system is shut down. If the Rain Shutdown function is on, and the total rainfall in the defined window of time goes above the shutdown limit, the machine stops and a Rain fault is logged in the system.

Enable Rain Shutdown

Check the **Rain Shutdown** checkbox to enable the rain shutdown function, and uncheck the checkbox to disable the rain shutdown function. Refer to Figure 73-1.

Setting Rain Shutdown Limit

To set rain shutdown limit follow these steps:

1. Push **Menu**, **Utilities**, **Weather**, and **Current Weather** to display the Current Weather screen.
2. Select the **Rain Shutdown Limit** field.
3. Using the numeric keypad, enter the number of inches. Example: 1, 5, 0 for 1.50. Refer to Figure 73-1.

The default value is 1.00 inch (25.4 mm). The rainfall is entered and displayed in inches or millimeters, depending on if English or Metric units have been enabled.

4. Push **Enter** to retain the value.

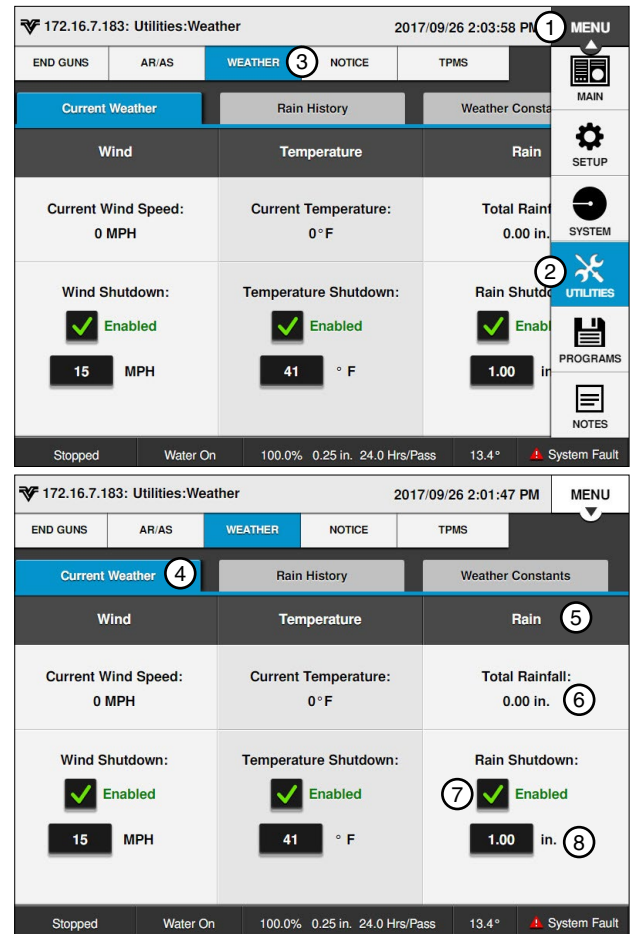

Figure 73-1 1. Menu 5. Rain
2. Utilities 6. Total Rainfall
3. Weather 7. Rain Shutdown Checkbox
4. Current Weather 8. Rain Shutdown Limit

Utilities / Weather

Rain History

The Rain History screen provides a summary of the daily rainfall totals for the current day since midnight and previous days. To view the Rain History screen push **Menu**, **Utilities**, **Weather**, and **Rain History**. Refer to Figure 74-1.

- NA means that panel was off.
- 0.00 means no rain was measured.
- Rain window is used for calculating rain shut-down.
- A 10-day rainfall history is stored in the system.

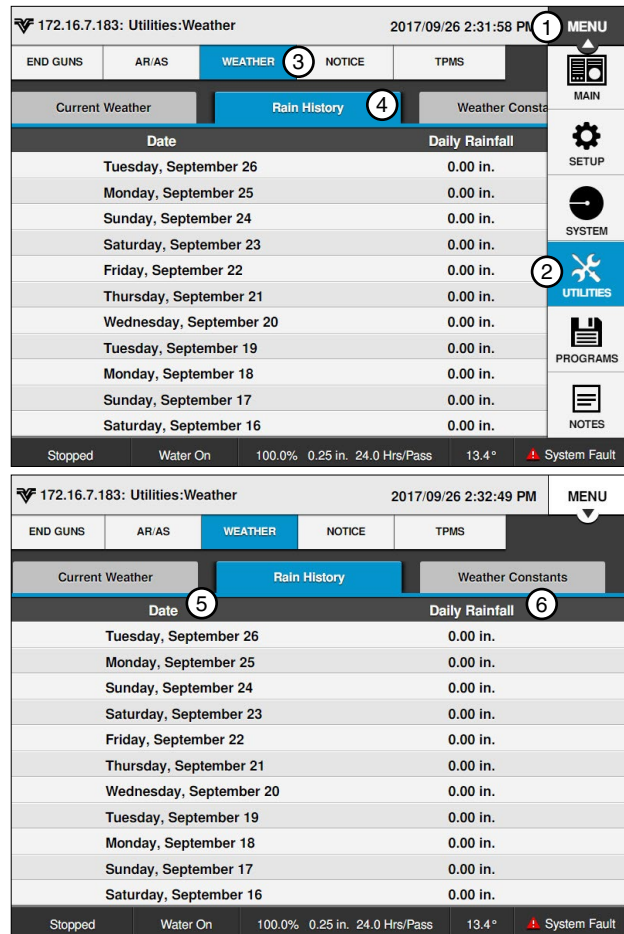

Figure 74-1 1. Menu 2. Utilities 3. Weather 4. Rain History 5. Date 6. Daily Rainfall

Weather Constants

The Weather Constants screen contains the constant values used by the Current Weather and Rain History screens.

Temperature Coefficient

Push **Menu**, **Utilities**, **Weather**, and **Weather Constants** to display the Weather Constants screen. Refer to Figure 75-1.

1. Select the **Temperature Coefficient** field.
2. Using the numeric keypad, enter the temperature coefficient. Example: 1, 7, 7, 8 for 17.78. Valid values are 0.00 - 99.9 mV/°C.

If you are using the air temperature sensor provided, its temperature coefficient has already been set up on the control panel. It is displayed as the default value, 17.78, for Temp Coefficient.

If you are using an air temperature sensor other than the one provided, it must be calibrated to work with the ICON10. Refer to its manufacturer's specifications for the temperature coefficient.

3. Push **Enter** to retain the value.

Temperature Offset

To set the temperature offset follow these steps:

1. Select the **Temperature Offset** field.
2. Using the numeric keypad, enter the temperature offset.

Example: to enter a negative number, push the **ABC** button, then push the +/- button and select -, then push the **123** button to return the numeric keypad and enter 1, 8, - for -18. Valid values are -500 - +500. The default value is -18. Refer to Figure 75-1.

3. Push **Enter** to retain the value.

Rain Window (days)

To set the number of days during which the total rainfall is calculated for use the Rain Shutdown field on the Weather Constants screen follow these steps:

1. Select the **Rain Window (days)** field.
2. Using the numeric keypad, enter the number of days (0 - 10). The default value is 1. Refer to Figure 75-1.
 - Enter 0 days to calculate the amount from midnight to the current time.
 - Enter 1 day to calculate the amount from all of yesterday plus the accumulation from midnight to the current time.

3. Push **Enter** to retain the value.

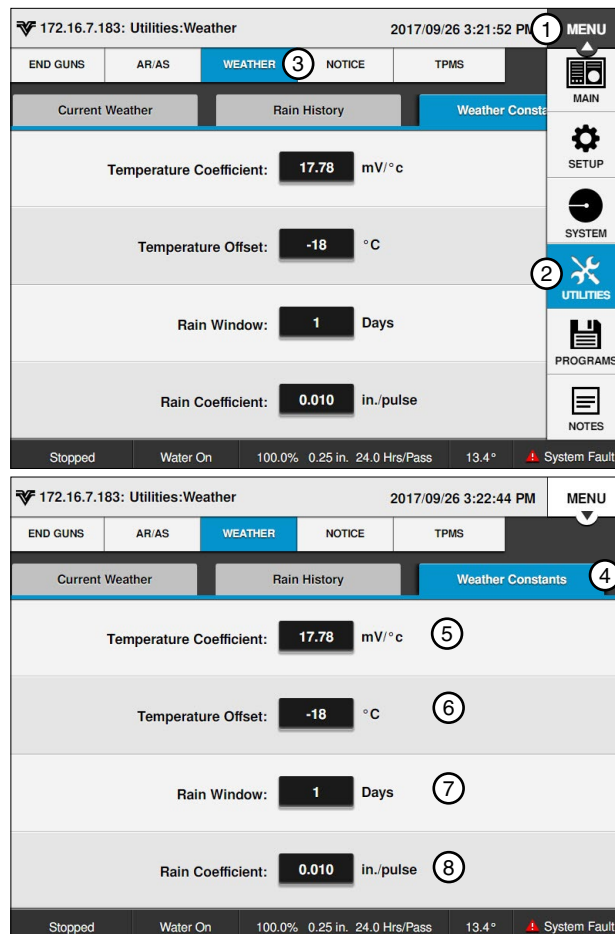

Figure 75-1 1. Menu 5. Temperature Coefficient
 2. Utilities 6. Temperature Offset
 3. Weather 7. Rain Window
 4. Weather Constants 8. Rain Coefficient

Rain Coefficient (inches/pulse)

1. Select the **Rain Coefficient (inches/pulse)** field.
2. Using the numeric keypad, enter the Rain Coefficient Inches per Pulse (Rain Coefficient inches/pulse). Example: 1, 0 for 0.010. Refer to Figure 75-1.

Most rainfall sensors are calibrated at 0.010 (factory default). Refer to the sensor manufacturer's specifications for the Rainfall Coefficient Inches per Pulse.

3. Push **Enter** to retain the value.

Utilities / Notice

Notice

Use the Notice screen to configure communications and enable event notifications for the real-time update feature, where the control panel is able to transmit a notice that its status has changed.

This provides the BaseStation with status information at the time that the change occurs, rather than requiring the BaseStation to request it at a later time.

Push **Menu**, **Utilities**, and **Notice** to view the Notice Setup screen. Refer to Figure 76-1.

Constants and Comm Port communications must be configured, and Menu/Utilities/Notice must be enabled before real-time updates notifies the BaseStation that the status has changed.

To enable notice:

1. The Comm Port must be configured based on method of communication with BaseStation.
2. Radio Setup must be configured base on the number of Hops required.
3. Selected Notice Events must be enabled.
4. The BaseStation software must be BaseStation3, version 3.5 or higher.
5. If a radio is used, it must be set to monitor channel busy information.
6. The radio and modem hardware must support the flow control signals in order to use the Clear To Send (CTS) or Data Carrier Detect (DCD) settings.
7. Reprogramming the radio with modifications, or replacing the modem and harness may be necessary. Contact your Valley dealer for more information.

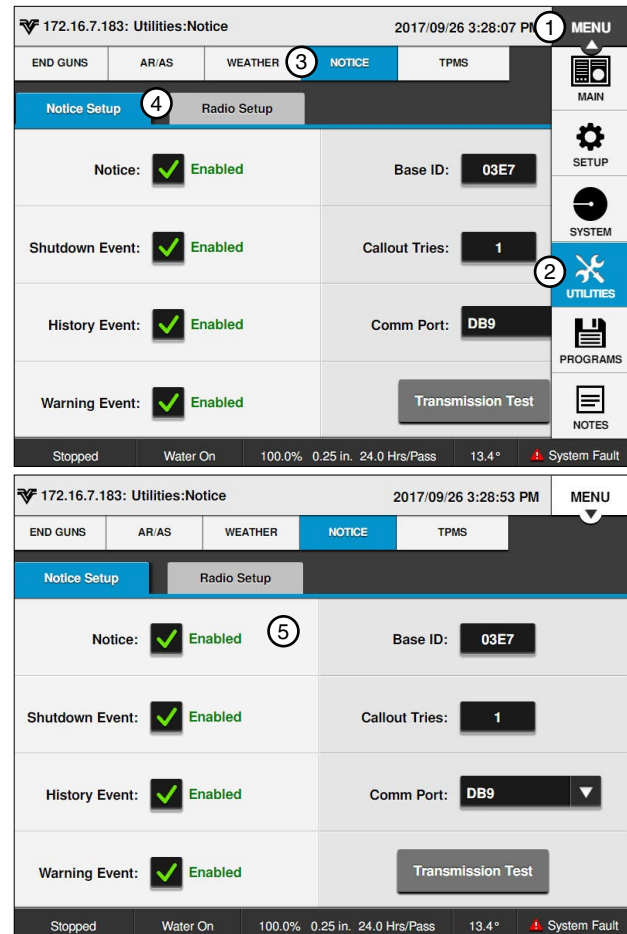

Figure 76-1 1. Menu
2. Utilities
3. Notice
4. Notice Setup
5. Notice Checkbox

Event Notifications

There are three Event Notifications:

- Shutdown Events are defined as anything that stopped the machine including commanded stops or faults.
- History Events are defined as anything that causes a history record to be saved by the SRB.
- Warning Events are defined as informational events indicating some action may need to be taken.

The default state for all event notifications is Disabled.

When an event is enabled and the event occurs, a real-time update is sent from the SRB to the BaseStation when the radio channel is clear. Refer to the BaseStation3 Owner's Manual for configuration of real-time updates alarms in BaseStation.

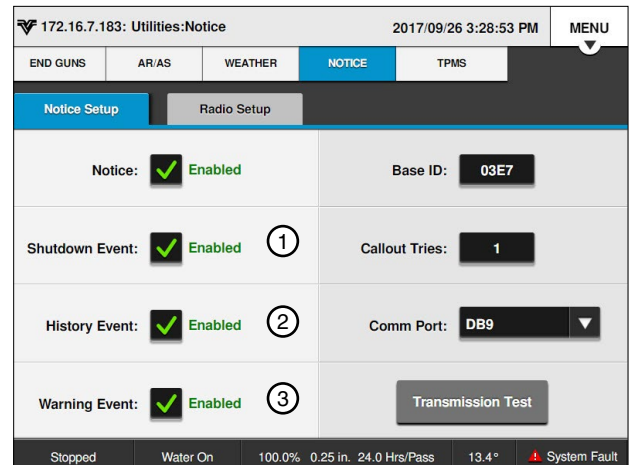

Figure 77-1 1. Shutdown Event 3. Warning Event
2. History Event

Enable/Disable Event Notifications

To enable or disable notification to the BaseStation3 for the listed Shutdown, History, or Warning events. Refer to Figure 77-2.

1. Push **Menu, Utilities, Notice** and **Notice Setup** to display the Notice screen. Refer to Figure 77-1.
2. Check the **Notice** checkbox to enable Notices.
3. Check the checkbox of the event to enable the Event Notification or uncheck the checkbox to disable the Event Notification.

A list of History and Warning Events is shown on the next page.

Shutdown Event	Description
System Power Lost	System power is lost
System Safety	System safety not sensed
Low Pressure	Water pressure is too low
Command	User commanded stop
SIS	SIS position reached
NVMEM	E01 error is active
For/Rev	For/Rev sense inputs both energized
Operating Sector	System position is not within operating sector
Wind	Wind is too high
Temperature	Temperature is too low
Daily Ops	Daily operation sequence completed
GPS Com	GPS not communicating
GPS Lock	GPS signal loss
Program	Program stop command
Auto-Stop	Auto-stop boundary reached
Flow	Flow rate is too low
High Pressure	Water pressure is too high
Tire Pressure	A tire's pressure is too low
Rain	Total rainfall is too high
Water Timer	Overwater shutdown time exceeded
Cut Cable	Span cable has been cut
PCB Hardware	PCB hardware issue detected
12V Power	12V power is lost
Position Encoder Comm	Position encoder not communicating
System Power Low	System power is too low
License	Protocol license is not valid

Figure 77-2 Shutdown Events

Utilities / Notice

History Events
System_Run_Stop_Status change
System_Percent_Timer change
System went from no programs running to one or more step or sector programs running, or vice-versa
Log Event program command executed
Auto_Restart_Possible change
Daily_Ops_Restart_Possible change
Cycle_Repeat_Restart_Possible change
System_Direction change
System_Water on/off change
SIS_Control on/off change
SIS_Position change
Cruise_Control enabled/disabled change
VRI-S_Status active/inactive change
VRI-Z_Status active/inactive change
VRI-iS_Status active/inactive change
Aux1 In active/inactive change
Aux2 In active/inactive change
Aux1 Out on/off change
Aux2 Out on/off change
End Gun on/off change
End Gun 1 on/off change
End Gun 2 on/off change
End Gun 3 on/off change
Spare pull-to-ground input active/inactive change
System crossed SIS_Position
Date changed (midnight)

Figure 78-1 History Events

Warning Events	Description
Transmission Test	This event occurs upon user request via VCP command.
Power Lost/Returned	This event occurs when a switch to or from the battery backup supply occurs, or on power up/reset of the unit.
Tire Pressure Low	This event occurs when the E26 error becomes active.
Battery Low	This event occurs when the battery backup supply voltage falls below 11V for at least 3 seconds but only if Battery Backup Control is enabled.
Cut Cable Detected	This event occurs when Cut Cable Detected transitions to true.
License Expiring Soon	This event occurs when it is 30 days, and then 7 days, and then 1 day from the current System Date to the protocol license expiration date. If the unit is powered off when one of these thresholds is reached, this event will occur when the unit is powered back up.

Figure 78-2 Warning Events

Base ID

Use Base ID to set the BaseStation identification number in the control panel. The factory default setting is 9999. Refer to Figure 79-1.

To set the Base ID follow these steps:

1. Push **Menu**, **Utilities**, and **Notice** to display the Notice Setup screen.
2. Select the **Base ID** field.
3. Enter the four-digit BaseStation RTU ID number.

Callout Tries

Use Callout Tries to set the number of callout tries the control panel makes to the BaseStation before abandoning the call and deleting the data. The factory default setting is 1.

To set the number of callout tries follow these steps:

1. Push **Menu**, **Utilities**, and **Notice** to display the Notice screen. Refer to Figure 79-1.
2. Select the **Callout Tries** field.
3. Enter the desired number of callout tries.
4. Push **Enter** to retain the value.

Comm Port

Use the Comm Port drop-down menu to select the Comm Port that will be used to communicate with BaseStation.

To select the Comm Port follow these steps:

1. Push **Menu**, **Utilities**, and **Notice** to display the Notice screen. Refer to Figure 79-1.
2. Select the **Comm Port** drop-down menu.
3. Choose the Comm Port.

Transmission Test

The Transmission Test button sends current status information through an optional communication device, such as a radio or phone modem, to another control panel or BaseStation equipped with a similar communication device. Use the Transmission Test button to test communications after installation. There is a random 0 to 10 second delay prior to the transmission of data.

Using the Transmission Test button

To transmit current status information, push **Menu**, **Utilities**, and **Notice** and push the **Transmission Test** button. Refer to Figure 79-1.

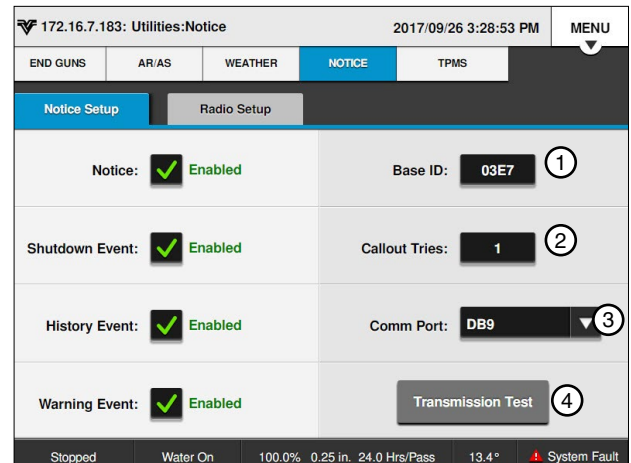

Figure 79-1 Notice Screen
 1. Base ID
 2. Callout Tries
 3. Comm Port Drop-Down
 4. Transmission Test

Utilities / Notice

Radio Setup

If Radio communication is used and the communication system uses an intermediate unit (radio) to pass data (hop) from the control panel on to the BaseStation, use the Radio Setup screen to set the number of Radio Hops and the Radio Hop IDs.

Number of Radio Hops

The Number of Radio Hops drop-down menu is used to setup the number of Radio Hops. Refer to Figure 80-1.

NOTE

- **BaseStation3 only supports one radio hop to an ICON control panel through another ICON control panel. Both control panels must be ICON control panels.**

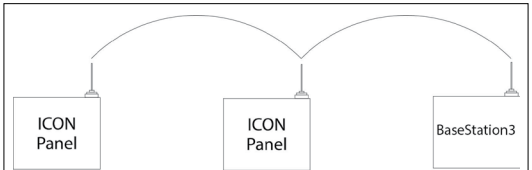

Radio Hop IDs

Use Radio Hop ID fields to setup the intermediate unit ID to be used by the control panel. Refer to Figure 80-1.

The Notice checkbox must be enabled before using Radio Hop.

Enabling/Disabling Radio Hops

To enable or disable Radio Hops follow these steps:

1. Push **Menu**, **Utilities**, **Notice**, and **Radio Setup** to display the Radio Setup screen. Refer to Figure 80-1.
2. Check the **Radio Hops** checkbox to enable Radio Hops or uncheck the Radio Hops checkbox to disable Radio Hops.
3. Select the **Number of Radio Hops** drop-down menu and select the preferred Number of Radio Hops. The maximum number of Radio Hops is 3.
Based on the number of radio hops the Radio IDs.
 - 1 Radio Hop - Provides Radio Hop ID 1
 - 2 Radio Hops - Provide Radio Hop IDs 1 and 2
 - 3 Radio Hops - Provide Radio Hop IDs 1, 2, and 3
4. Select the **Radio Hop 1, 2, or 3 ID** field and use the numeric keypad to enter the Radio Hop ID.
5. Push **Enter** to retain the value.
6. Repeat steps 4 and 5 as required.

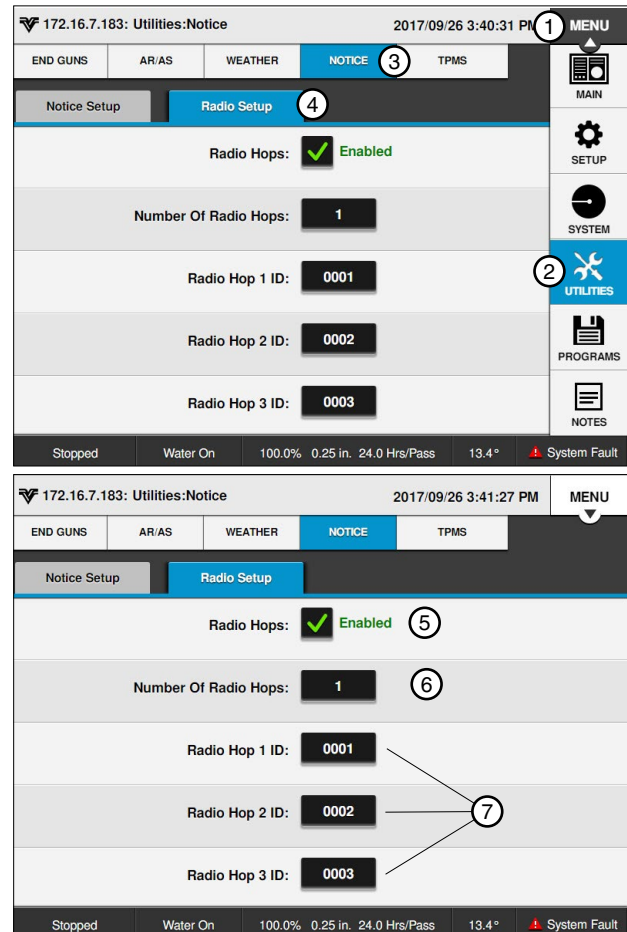

Figure 80-1 1. Menu 2. Utilities 3. Notice 4. Radio Setup 5. Radio Hops Checkbox 6. Number of Radio Hops 7. Radio Hop IDs

Tire Pressure Monitor System (TPMS)

The TPMS menu provides the options to view tire pressure data, set tire pressure constants, view results of tire pressure diagnostics, and to view water pressure data, constants, and diagnostics.

Push **Menu**, **Utilities**, and **TPMS** to display the TPMS menu. Refer to Figure 81-1.

TPMS Data

The Tire Pressure Data screen is only available when the TPMS Tire Pressure protocol is enabled in Setup/Comm Port/PLC. To review tire pressure information follow these steps:

1. Push **Menu**, **Utilities**, **TPMS**, and **TPMS Data** for the Tire Pressure Data screen. Refer to Figure 81-1.
2. Choose the tower number to display current information.
3. Verify the tire pressure readings at each tire position shown (REV, MR, MF, FOR). Only tires with a valid sensor ID configured on the tower are shown.
4. View the tire status displays, which can be:
 - Old - Sensor or TPMS has not responded for two or more hours.
 - Low - Tire pressure is at or below Warning Pressure value.
 - OK - Pressure is above Warning Pressure value.
 - N/A - There is no data to show.

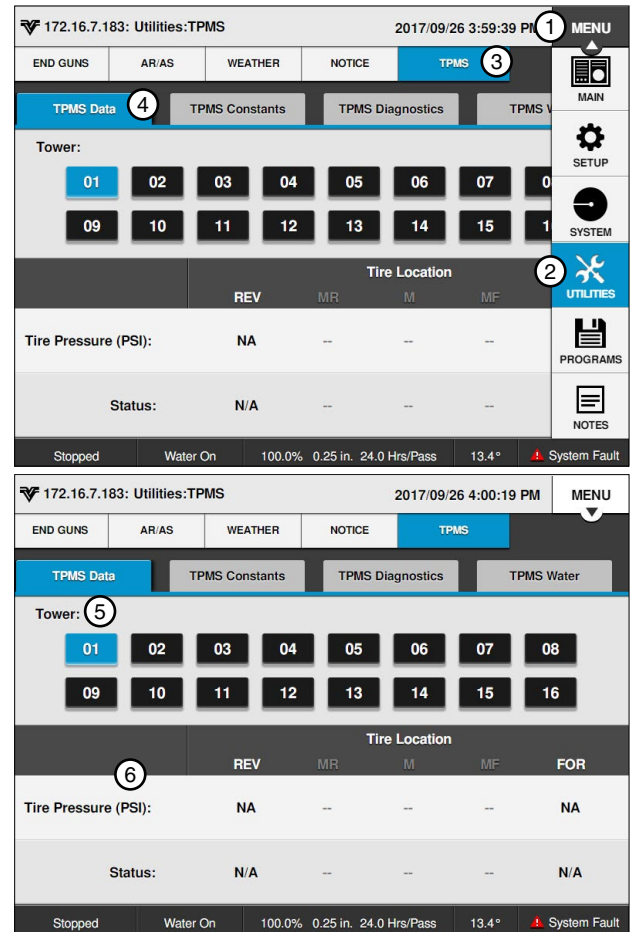

Figure 81-1 1. Menu 2. Utilities 3. TPMS 4. TPMS Data 5. Tower 6. Tower Information

Utilities / TPMS

TPMS Constants

The TPMS Constants screen is used to set the following constants. Refer to Figure 82-1:

- TPMS Shutdown
- Below Nominal Warning Pressure
- Below Nominal Shutdown Pressure

TPMS Shutdown

The system can be set to shut down if tire pressure falls below a set amount. Figure 82-1.

1. Push **Menu**, **Utilities**, **TPMS**, and **TPMS Constants** for the Tire Pressure Constants screen.
2. Check the **TPMS Shutdown** checkbox to turn TPMS Shutdown on.

The system default is off (unchecked).

Warning Pressure

A warning can be provided if tire pressure falls below a certain amount.

1. Select the **Warning Pressure** field.
2. Using the numeric keypad, enter the pressure value for the pressure drop warning. Refer to Figure 82-1.

The default is 4 psi (27 kPa), and the range is 1 psi (6 kPa) to 15 psi (103 kPa).

3. Push **Enter** to retain the value.

Shutdown Pressure

1. With TPMS Shutdown turned on, select the **Shutdown Pressure** field.
2. Using the numeric keypad, enter the pressure value for the pressure drop shutdown.

The system default is 6 psi (41 kPa), and the range is 1 psi (6 kPa) to 15 psi (103 kPa).

3. Push **Enter** to retain the value.

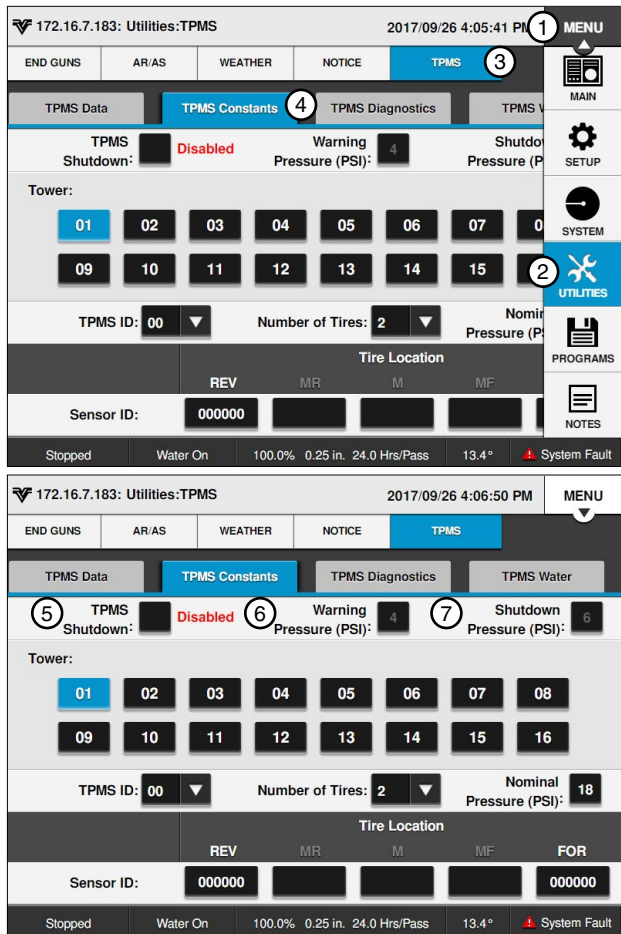

Figure 82-1 1. Menu 5. TPMS Shutdown
 2. Utilities 6. Warning Pressure
 3. TPMS 7. Shutdown Pressure
 4. TPMS Constants

TPMS Sensor

The TPMS Sensor Setup screen is used to set the following sensors for any tower. Refer to Figure 83-1.

- TPMS ID
- Number of Tires
- Sensor IDs
- Nominal Pressure

To setup sensors follow these steps:

1. Push **Menu**, **Utilities**, **TPMS**, and **TPMS Sensor** for the Tire Pressure Monitor System Constants screen.
2. Select the tower number. Tower 1 is the tower closest to the pivot point. The range is 1-16. Refer to Figure 83-1.
3. Select the **TPMS ID** drop-down menu, choose the **TPMS ID** that receives signals from pressure sensors on this tower.
The default ID is 00, and the range is 0-9 and 0A-0F.
4. Select the **Number of Tires** drop-down menu, choose the number of tires on this tower. The default number of tires is 2, and the range is 2 - 4.
5. Select the **Nominal Pressure** field.
6. Using the numeric keypad, enter the recommended inflation pressure value for the tires on this tower. The default is 18 psi (124 kPa) and range is 6 psi (41 kPa) to 37 psi (255 kPa).
7. Push **Enter** to retain the value.
8. Select one of the **Sensor ID** fields. Refer to Figure 83-1.
9. Using the numeric keypad, enter the six-digit tire sensor ID in the specified order for the number of tires selected, the default sensor ID is 000000.
 - Two tires - Enter the reverse (REV) tire sensor ID and the forward (FOR) tire sensor ID
 - Three tires - Enter the reverse tire sensor ID, the mid (M) tire sensor ID, and the forward tire sensor ID
 - Four tires - Enter the reverse tire sensor ID, the mid-reverse (MR) tire sensor ID, the mid-forward (MF) tire sensor ID and the forward tire sensor ID
10. Push **Enter** to retain the value after each sensor ID entry.
11. Repeat steps 2 - 10 for other towers.

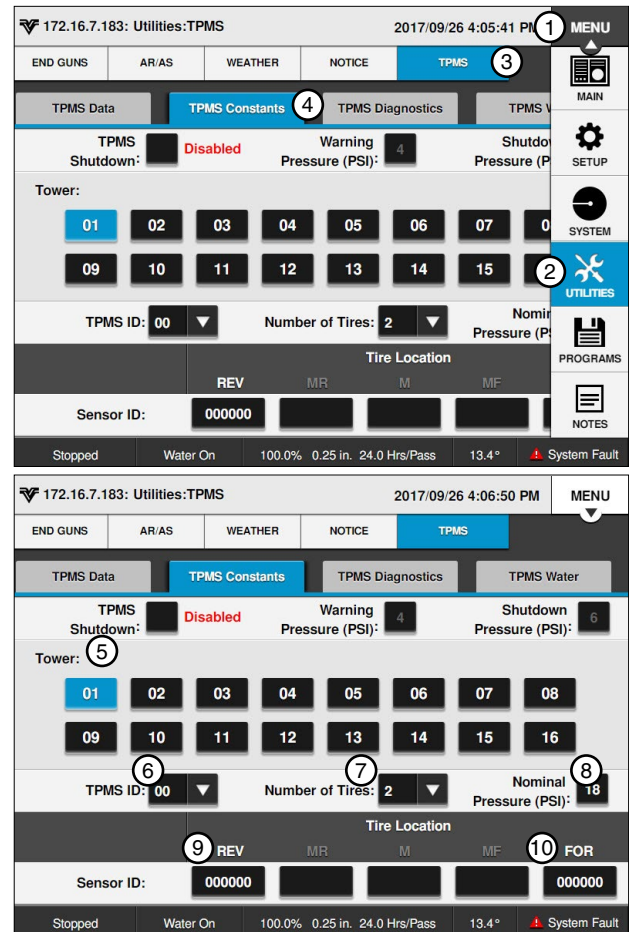

Figure 83-1

1. Menu	6. TPMS ID
2. Utilities	7. Number of Tires
3. TPMS	8. Nominal Pressure
4. TPMS Constants	9. Rev Sensor ID
5. Tower	10. For Sensor ID

Utilities / TPMS

TPMS Diagnostics

The TPMS Diagnostics screen displays the tire pressure sensor battery level, a signal acknowledgement, and Minutes Since Last Received update. Refer to Figure 84-1.

To view the Tire Pressure Diagnostics screen follow these steps:

1. Push **Menu**, **Utilities**, **TPMS**, and **TPMS Diagnostics** for the Tire Pressure Diagnostics screen.
2. Select the tower to view diagnostic information.
3. Observe the data to make sure all sensors are working correctly. Verify the number of tires on the tower, sensor battery levels, status, and Minutes Since Last Received update.
 - Tire positions shown are based on pivot tower sensor setup number of tires (REV, MR, MID, MF, FOR). Only tires with a valid sensor ID configured on the tower are shown.
 - Battery (sensor battery level) is either OK, Low, or - - (no information).
 - Status may display OK, - - (no information), or one of the following:
 - » NA-Not Available: The control panel has not requested data yet.
 - » NR-No Response: While running or waiting, the TPMS box did not respond to last data request.
 - » NS-Never Seen: The sensor never reported to the TPMS box.
 - Last Updated (minutes since last received update) is shown, or - - (no information). Update frequency is approximately every two minutes.

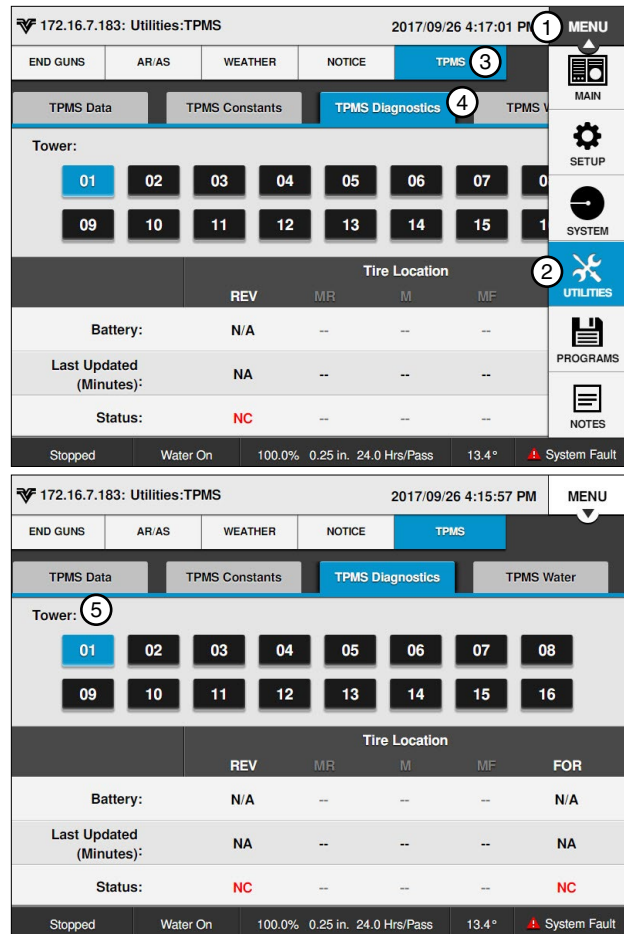

Figure 84-1 1. Menu 2. Utilities 3. TPMS 4. TPMS Diagnostics 5. Tower

TPMS Water

The TPMS Water screen displays the TPMS Water Constants, Data, and Diagnostics.

Push **Menu**, **Utilities**, **TPMS**, and **TPMS Water** to view the TPMS Water screen. Refer to Figure 85-1.

TPMS Water Constants

The TPMS Water Constants section of the screen is used to view or change the TPMS and Sensor ID numbers for the TPMS water pressure. Refer to Figure 85-1.

1. On the TPMS screen, select the **TPMS ID** drop-down menu, and choose the TPMS tower box ID that receives signals from the water pressure sensor near this tower.

The default ID is 00, and the range is 0-9 and 0A-0F. Refer to figure 85-1.

2. Select the **Water Sensor ID** field and enter the six-digit water pressure sensor ID, using the numeric keypad. The default Sensor ID is 000000.

3. Push **Enter** to retain the value.

TPMS Water Data

The TPMS Water Data section of the TPMS Water screen provides information about water pressure from the TPMS Water Pressure. It also indicates when the last update was made to this information.

Observe the data to ensure that the TPMS Water Pressure is operating correctly. Verify the Water Pressure and Last Updated.

TPMS Water Diagnostics

The Water Pressure Diagnostics section of the TPMS Water screen displays the sensor Battery level and Status.

Observe the data to verify the sensor is working correctly. Verify the sensor Battery level and Status.

- Battery (sensor battery level) is either OK, Low, or - - (no information).
- Status may display OK, - - (no information), or one of the following:
 - » NA-Not Available: The control panel has not requested data yet.
 - » NR-No Response: While running or waiting, the TPMS box did not respond to last data request.
 - » NS-Never Seen: The sensor never reported to the TPMS box.

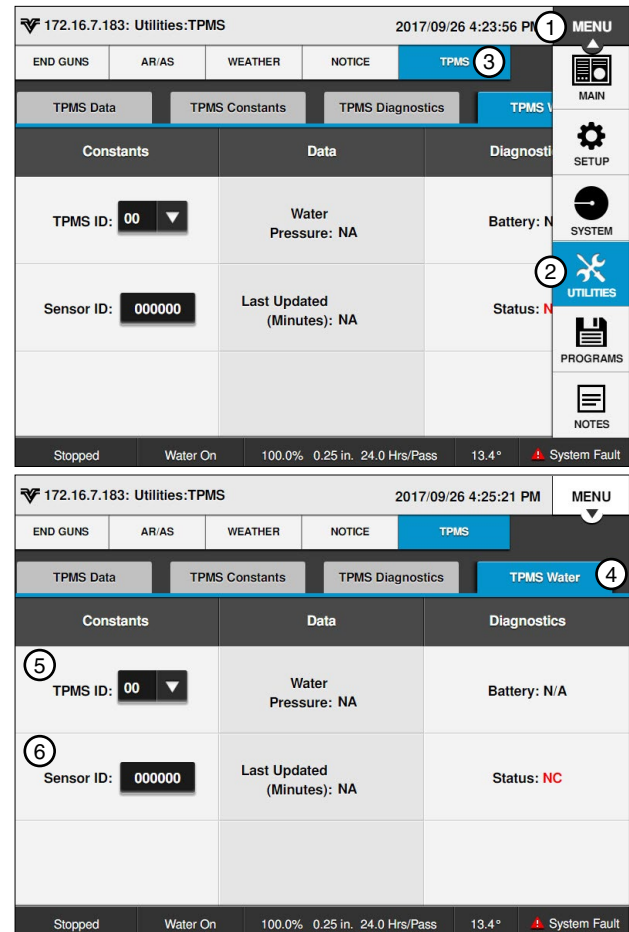

Figure 85-1 1. Menu 4. TPMS Water
2. Utilities 5. TPMS ID
3. TPMS 6. Sensor ID

Programs Menu

Push **Menu** and **Programs** to display the Programs menu. The user can change settings or view information from the Programs menu at any time. The following flowchart is provided to help you navigate the Programs menu. Refer to Figure 87-1.

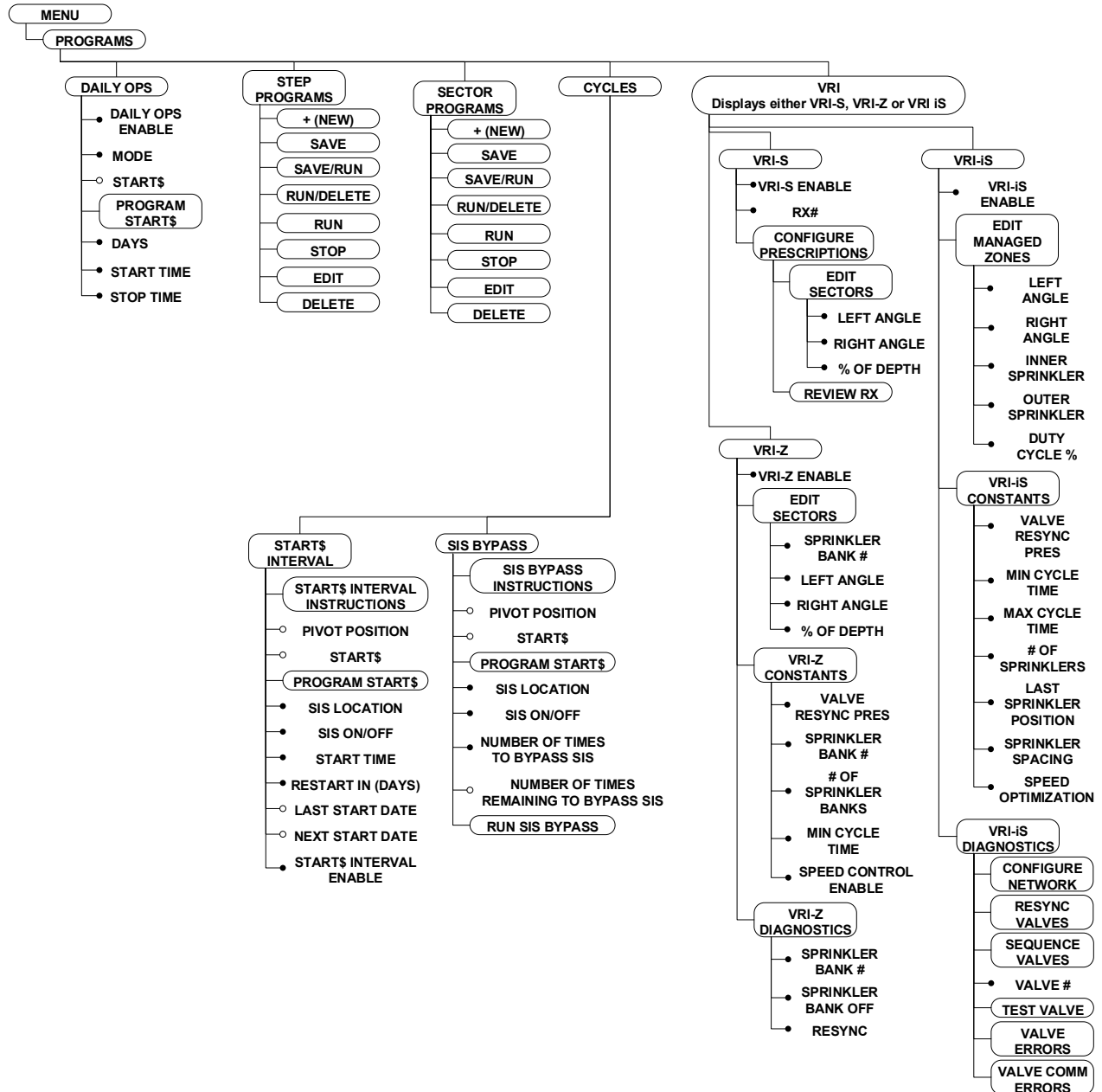

Figure 87-1

Programs

Daily Ops

Daily Ops is used to execute the START\$ or STOP\$ programs at set times on selected days. Daily Ops works in conjunction with any other program. There are two Daily Ops modes: Daily Operations mode and Load Management mode. Refer to Daily Ops program examples in the Step Program Examples section.

NOTE

- For Daily Ops to work correctly in all applications, the START\$ must be programmed.

Enable/Disable Daily Ops

The Daily Ops checkbox is used to enable or disable Daily Ops. Daily Ops must be enabled for the machine to start and stop on the specified days and times. The factory default setting is disabled (unchecked).

Enabling Daily Ops and setting the mode to Daily Ops displays the restart message in the Main screen status indicating that the machine can start at anytime. However, this does not automatically cause the power/pressure Auto Restart to be active.

If Daily Ops is disabled, or if Daily Ops is enabled but the mode is set to Load Management and Restart Activated is unchecked, restart is not displayed in the Main screen status.

If the machine is stopped by a pressure or power fault, and Auto Restart is enabled, the machine auto restarts unless the attempted auto restart is outside of the Daily Start/Stop time window. The Daily Ops mode is reactivated only if the Daily Ops mode was activated prior to the shutdown.

If the machine is stopped, either at the panel or remotely, the Restart function will not restart the machine at the Daily Start/Stop start time until the machine has been started again.

Setting Daily Operations

To set Daily Ops follow these steps:

1. Push **Menu**, **Programs**, and **Daily Ops** to display the Daily Ops screen. Refer to Figure 89-1.
2. Check the **Daily Ops** checkbox to enable Daily Ops or uncheck the checkbox to disable Daily Ops.
3. Select the **Mode** drop-down menu and choose **Daily Operations** or **Load Management**.

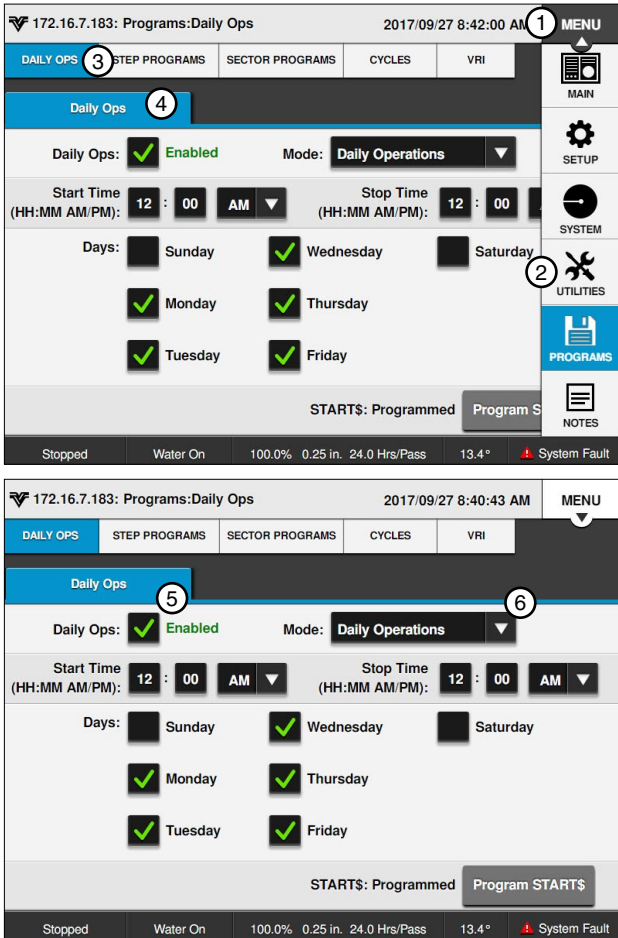

Figure 89-1 1. Menu 2. Programs 3. Daily Ops 4. Daily Ops 5. Daily Ops Check Box 6. Mode

Programs / Daily Ops

Daily Operations Mode

The Daily Operations mode has two functions:

1. Start and stop the machine at regular predefined times for selected days of the week.
2. Provide a shutdown mechanism with a lockout feature for energy rate contract eligibility.

When DAILY Ops is on and Daily Operations Mode is selected/active, the following apply:

- If the current day is selected in Daily Operations, and it is the start time, the START\$ program runs and the machine starts. Refer to Figure 90-1.
- If the start time comes before the stop time, and the current day is selected in Daily Operations, and it is the stop time, the STOP\$ program runs and the machine stops.
- If the stop time comes before the start time, and the previous day is selected in Daily Operations, and it is the stop time, the STOP\$ program runs and the machine stops.
- The lockout feature shuts the machine down if a start attempt is made outside of the daily start/stop time window. If the Start button is pressed, the machine runs for five seconds without water, and a Daily Ops fault is logged after the machine stops. Daily Ops must be disabled in order to run the machine outside of the daily start/stop time window.
- If the system time is changed to a time outside the daily start/stop time window, the machine shuts down. If the machine is stopped by the stop button it will not automatically restart.
- The Daily Operations mode can only be deactivated by disabling Daily Ops.
- Stop-In-Slot, auto-stop or a programmed stop WILL NOT deactivate the Daily Operations mode.

Load Management Mode

The Load Management mode has two functions.

- Start and stop the machine at regular predefined times for selected days of the week.
- Provide a load management shutdown mechanism without a lockout feature.

When Daily Ops is enabled and the Load Management mode is selected and Restart Activated is checked, the following apply:

- If the current day is selected in Daily Start/Stop, and it is the start time, the START\$ program runs and the machine starts. Refer to Figure 90-1.
- If the start time comes before the stop time, and the current day is selected in Daily Start/Stop, and it is the stop time, the STOP\$ program runs and the machine stops.

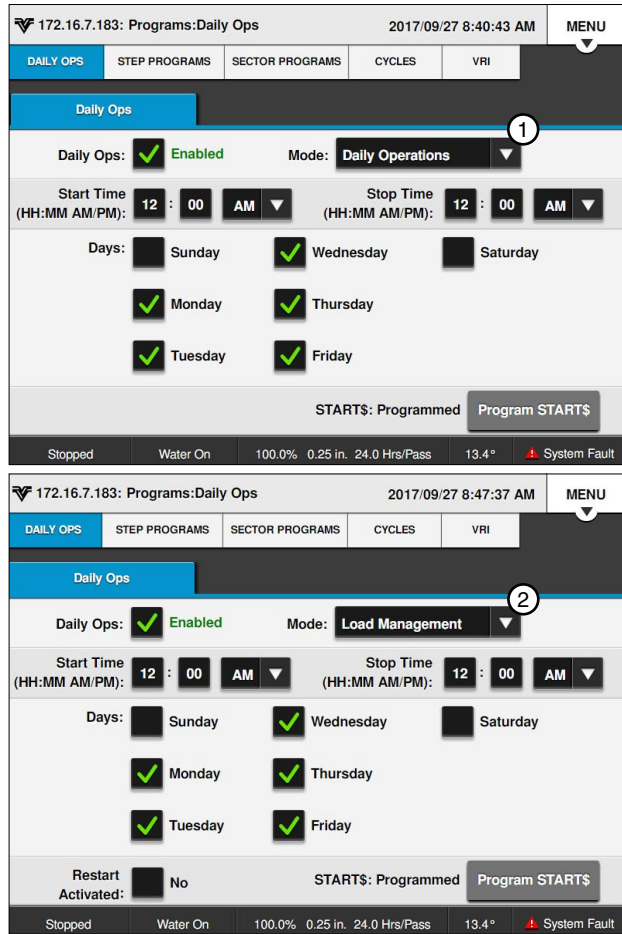

Figure 90-1 Daily Ops Screen
1. Daily Ops Mode
2. Load Management Mode

- If the stop time comes before the start time, and the previous day is selected in Daily Start/Stop, and it is the stop time, the STOP\$ program will NOT run. The machine continues to run until the next stop time on the next selected day in Daily Start/Stop, unless the user or a program stops the machine. Load Management does not stop the machine on days not selected for Load Management.
- The machine can be started at any time when Load Management is enabled. The machine continues to run until a stop time and day is reached.
- When Load Management is selected but not active, if any start command occurs, Load Management is activated. The user can manually activate the Load Management mode on the Daily Ops screen.
- The Load Management mode is deactivated when any stop command other than a Daily Ops commanded stop occurs. The machine stops, and the mode is deactivated. If Daily Ops commanded the last stop, the Daily Operations mode remains activated.
- Stop-In-Slot, Auto-Stop, or a programmed stop deactivates the Load Management mode.

START\$ Program

The START\$ Program is a special command string program that does not have a condition for the first step because it is executed immediately when commanded, either by another program or a machine function such as the CYCLE\$ Execute command, the Power Restart option, or the Daily Ops function. Refer to START\$ Program examples in the Step Program Example section. The default Start\$ Program has 1 step with a Delay condition of 10 minutes and a single command of Start.

Listed below are important details about the START\$ Program.

- The START\$ Program can only be programmed for one situation at a time.
- The START\$ Program does not automatically start the machine unless the Start command is in the START\$ Program.

CAUTION

- **A DELAYED START IS RECOMMENDED TO REDUCE THE POSSIBILITY OF DAMAGE TO AN ELECTRIC PUMP IF POWER IS LOST AND REGAINED IN A SHORT PERIOD OF TIME.**

Programs / Daily Ops

Using START\$

To edit a START\$ program, follow these steps (refer to the START\$ program examples in the Step Program Examples section). Refer to Figure 92-1.

1. Push **Menu, Programs, Daily Ops**, and push the **Program START\$** button to display the Program START\$ screen.
2. Push the **Settings** button (gear icon) at the top left corner of the Program START\$ screen to edit the conditions at which the current step will start.
3. The default condition is Delay. If Delay is not selected select the **Choose Condition** drop-down menu and choose **Delay**. Refer to Figure 92-2.
 - a) Select the **Delay Time** field, use the numeric keypad to enter the delay time, push **Enter** to retain the value.
 - b) Push **Seconds** or **Minutes**.
 - c) Push **Enter** to retain the selections or **Cancel** to return to the default selections.
4. To add a command, select the **Choose Command** drop-down menu on the Program START\$ screen.
5. Set the parameters as required for the selected command.

NOTE

•The START\$ program **MUST** contain the **Start** command in order to start the machine.

6. To add steps to the program push the **Add Step** button.
7. To scroll through multiple steps within a program use the **Next Step** or **Previous Step** buttons.
8. Finish the program by selecting one of the following. Refer to Figure 92-3.
 - Push **Save** to save the changes to the program.
 - Push **Cancel** to cancel the changes to program.

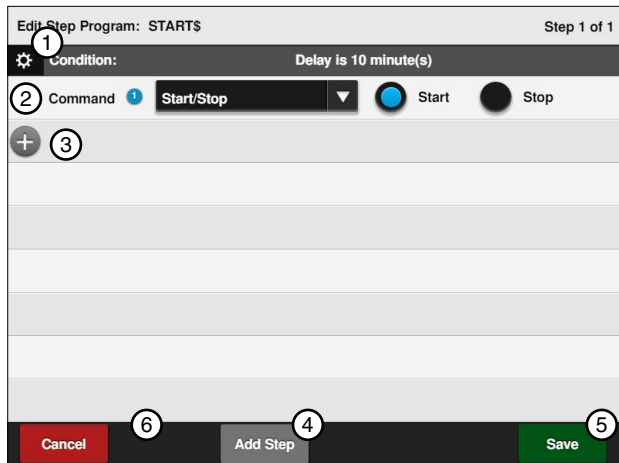

Figure 92-1 1. Settings 4. Add Step
2. Command Drop-Down 5. Save
3. Add Command 6. Cancel

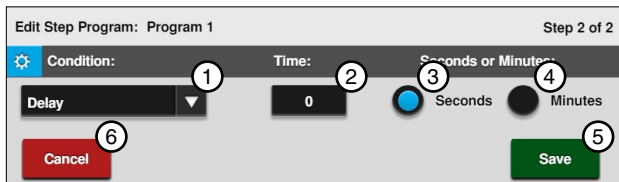

Figure 92-2 1. Condition Drop-Down 4. Minutes
2. Delay Time 5. Save
3. Seconds 6. Cancel

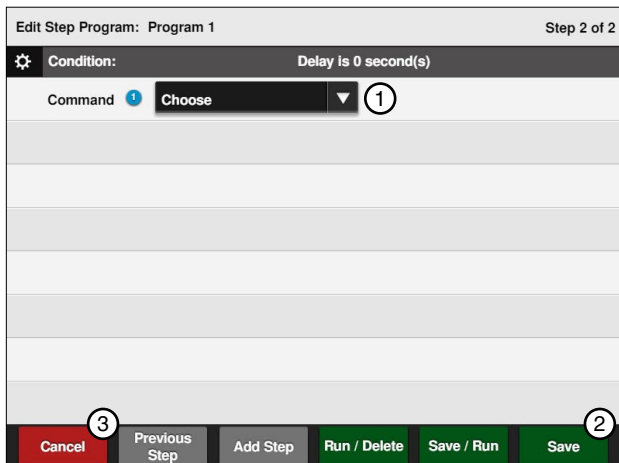

Figure 92-3 1. Choose Command Drop-Down
2. Save
3. Cancel

Configure Times

Configure Times is used to set the daily machine start time and daily machine stop time for Daily Ops to be active. When 24 hour clock format is enabled in Menu/Setup/Display/Date/Time, daily start and stop times are entered in 24 hour clock format. For example, a time of 6:00 PM is entered as 18:00 hours or a time of 10:00 AM is entered as 10:00 hours. Factory default value is 00:00. Refer to Figure 93-1.

Setting Times

To set daily machine start and stop times for Daily Ops to be active follow these steps:

1. Push **Menu, Programs, and Daily Ops** to view the Daily Ops screen.
2. Select the **Start Time** fields to enter the start time.
3. Push **Enter** to retain the value.
4. Push the **AM** or **PM** button.
5. Select the **Stop Time** fields to enter the stop time.
6. Push **Enter** to retain the value.
7. Push the **AM** or **PM** button.

Configure Days

The Days checkboxes are used to set the day(s) of the week for Daily Ops to be active.

Setting Days

To set day(s) of the week for Daily Ops to be active follow these steps:

1. Push **Menu, Programs, and Daily Ops** to view the Daily Ops screen.
2. Check the checkbox corresponding to the preferred days of week for Daily Ops to be active.

Restart Activated (for Load Mgmt Mode)

The Restart Activated checkbox is used to restart the machine at the next programmed time regardless of how the machine was shut down. If Restart Activated is not enabled the machine must be shut down by Load Management in order to start up by Load Management.

To enable and disable the Restart Activated option follow these steps:

1. Push **Menu, Programs, and Daily Ops** to view the Daily Ops screen.
2. Check the **Restart Activated** checkbox to enable the Restart Activated option.
3. Uncheck the **Restart Activated** checkbox to disable the Restart Activated option.

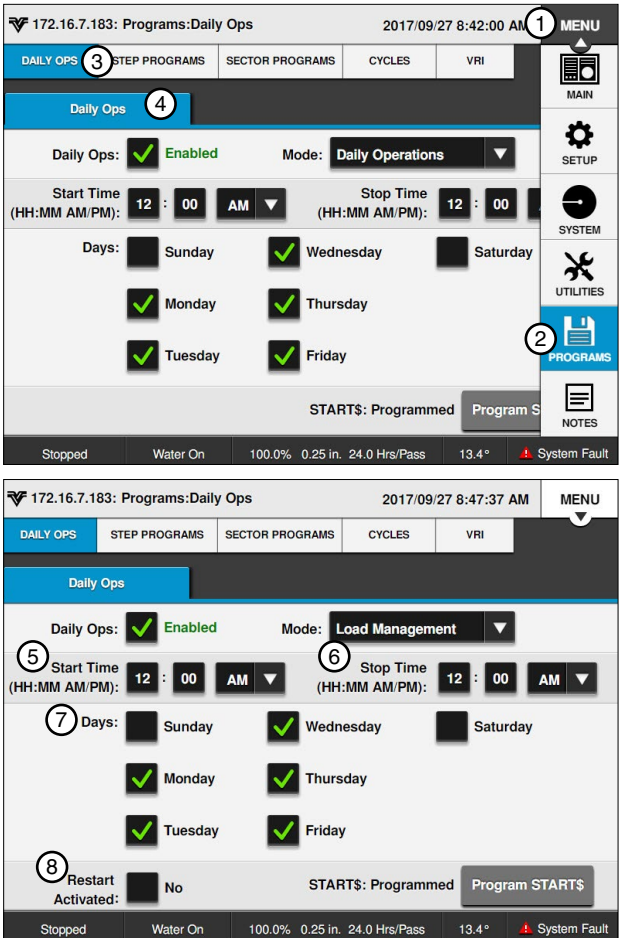

Figure 93-1 1. Menu 5. Start Time Fields
 2. Programs 6. Stop Time Fields
 3. Daily Ops 7. Days
 4. Daily Ops 8. Restart Activated

Step Programs

From the Step Programs screen the user can choose to create, edit, store, run, review, and erase Step Programs.

Push **Menu**, **Programs**, and **Step Programs** to view the Step Programs screen. Refer to Figure 95-1.

Use Step Programs to execute one or more commands, options, or a stored Step Program based on a selected programming condition. The user can program up to 17 Step Programs, with a maximum of 9 steps in each. The steps in a program are executed in numerical order.

Up to seventeen programs can be run at the same time. If more than one program is running, the computer continuously scans all of the running programs and looks for an active step with a condition which is met.

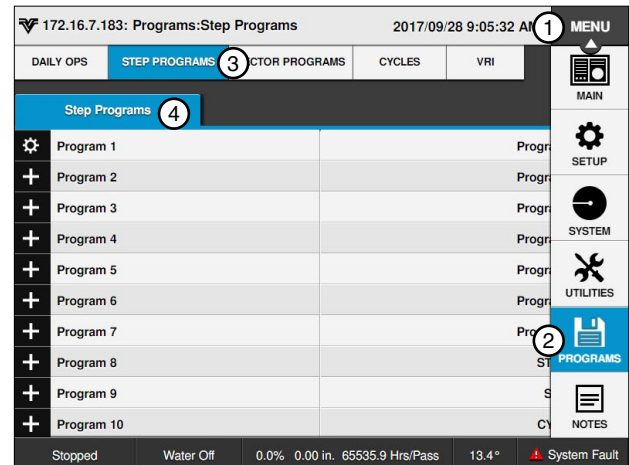

Figure 95-1 1. Menu
2. Programs
3. Step Programs
4. Step Programs

Step Programs Functions

- New - used to write new Step Programs.
- Run - used to load stored Step Programs in current memory for execution.
- Stop - used to stop a selected Step Program from running.
- Delete - used to delete stored Step Programs which can be recalled for execution.
- Edit - used to edit stored Step Programs.

Available Commands		Stored Program
<ul style="list-style-type: none"> • Start/Stop • Direction Forward/Reverse • Water On/Off • Depth • Percent • Auxiliary 1 On/Off • Auxiliary 2 On/Off • SIS On/Off • Run Program • ARAS Auto Reverse/Auto Stop • Auto Restart • Delete Command • Set Cycle 	<ul style="list-style-type: none"> • % of %, Adjust % Timer • % of Depth, Adjust Depth by a % • Log Event • VRI ON/OFF • Cruise Control Off • Cruise Control On • 12V Power • Display Ignition • End Gun 1 • End Gun 2 • End Gun 3* • End Gun 4* 	<ul style="list-style-type: none"> • Any stored Step Program can be run from the last step of another Step Program. Refer to the Run Program command in this section of this manual.

* PLC End Gun 3 / 4 must be enabled in Menu/Setup/Comm Port

Programs / Step Programs

Programming Conditions

- Date/Time - a condition that executes commands based on the date and time of day.
- Day/Time - a condition that executes commands based on the day of the week and time of day.
- Position - a condition that executes commands based on the position of the machine.
- Pressure - a condition that executes commands based on water Pressure.
- Delay - a condition that executes commands based on a time delay of up to 60,000 seconds (16.67 hours) or 60,000 minutes (41.67 days).
- Direction - a condition that executes commands based on the direction of the machine movement.

Other Programming Conditions

- Analog • Pulse Rate • Wind • Spare PTG • Pressure Switch
- Aux 1 • Pulse Count • Rain • End Gun • Cable Theft
- Aux 2 • Remote Start • Temp • Safety Sense

Analog

The Analog programming condition is based on an analog voltage being higher or lower than the set value. This condition can only be used if an external device with an analog voltage output is connected to the control panel.

Analog Conditions

- Temp • Aux Monitor • Pressure (VGPS)
- Wind • Main Supply
- (mV) Pressure • Battery Supply
- (mA) Pressure • 12V Out

Pulse Rate

The Pulse Rate programming condition is based on pulse per minute rates of a counter (for example, rain, wind, or flow) being higher than a set value. This condition can only be used if a device with a pulse output is connected to the control panel.

Pulse Count

The Pulse Count programming condition is based on pulse counts (for example, rain wind, or flow) being higher or lower than a set value. This condition can only be used if a device with a pulse output is connected to the control panel.

Wind

The Wind programming condition is based on the wind speed being higher or lower than a set value. The minimum is 0 mph (0 km), and the maximum is 300 mph (482.8 km). This condition can only be used if a wind speed sensor is installed.

Rain

The Rain programming condition is based on the rainfall being higher or lower than a set level. The minimum is 0.00 in (0.00 mm), and the maximum is 9.99 in (253.7 mm). This condition can only be used if a rainfall sensor is installed.

Other Programming Conditions (Continued)

Temperature

The Temperature programming condition is based on the temperature being higher or lower than a set level. The minimum value is 14°F (-10°C) to 176°F (80°C). This condition can only be used if a temperature sensor is installed.

End Gun

The End Gun programming condition is based on whether the selected End Gun is on or off. This condition can only be used if an end gun is installed. End Gun 3 and 4 require additional hardware.

Aux 1 and 2

The Aux 1 and 2 programming conditions are based on the whether the selected output or input is on or off. This condition can only be used if an auxiliary component is installed.

Remote Start

The Remote Start programming condition is based on whether the remote start feature is on or off.

Pressure Switch

The Pressure Switch programming condition is based on whether the pressure switch is on or off. This condition can only be used if a pressure switch is installed.

Spare PTG

The Spare PTG programming condition is based on whether the signal from an external device is on or off.

Safety Sense

The Safety Sense programming condition is based on whether the safety circuit is on (energized) or off (de-energized).

Cable Theft

The Cable Theft programming condition is based on whether a cut span cable has been detected. Cable Theft On means a cut span cable has been detected and Cable Theft Off means that a cut span cable has not been detected. This only applies if cable theft has been activated by BaseStation.

Programs / Step Programs

Run Program Command

A stored Step Program can be loaded and run from the last step within the same, or another Step Program. It is recommended that the Run Program command be the last command in the last step of the program.

This programming feature can be used to run the same program over, or run programs in a sequence. For example, if there are three stored programs that need to be run in sequence, the last step of program 1 would command program 2 to run. The last step in program 2 would command program 3 to run. The last step in program 3 would command program 1 to run, starting the sequence over.

To add the Run Program command to the last step in another program follow these steps:

1. Push **Menu**, **Programs**, and **Step Programs** to view the Step Programs screen.
2. Push the **Settings** button corresponding to the program number. Refer to Figure 98-1.
3. Push the **Edit** button.
4. Select the **Choose Command** drop-down menu and choose **Run Program**.
5. Select the **Choose Program** drop-down menu and choose the program that you want to run. Refer to Figure 98-2.
6. Finish the program by pushing the **Save** button and selecting one of the following.
 - Push **Save** to save the program.
 - Push **Save / Run** to save and then run the program.
 - Push **Run / Delete** to run and then delete the program.
 - Push **Cancel** to return to the main step program page.

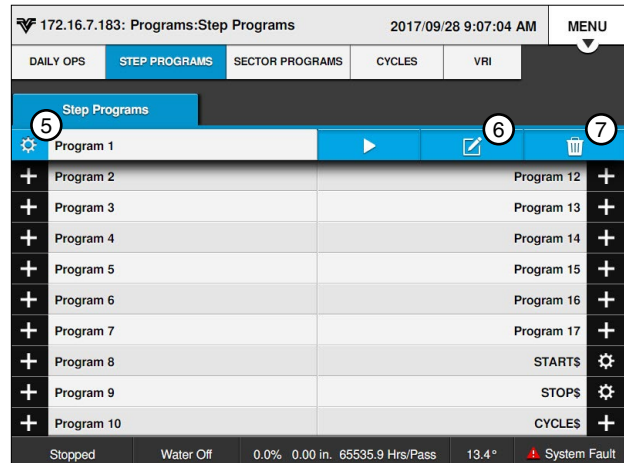
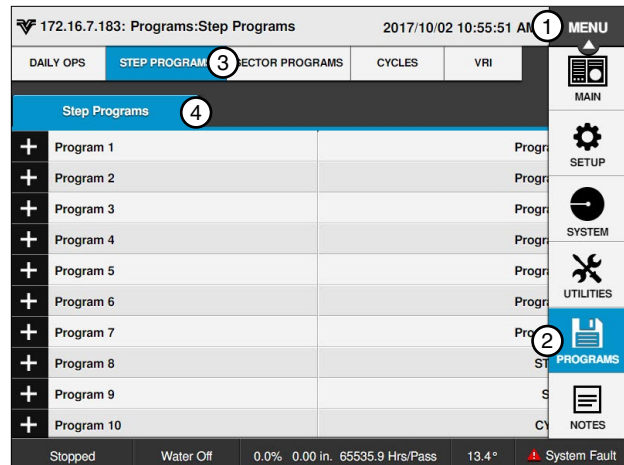

Figure 98-1 1. Menu 5. Settings
 2. Programs 6. Edit
 3. Step Programs 7. Delete
 4. Step Programs Screen

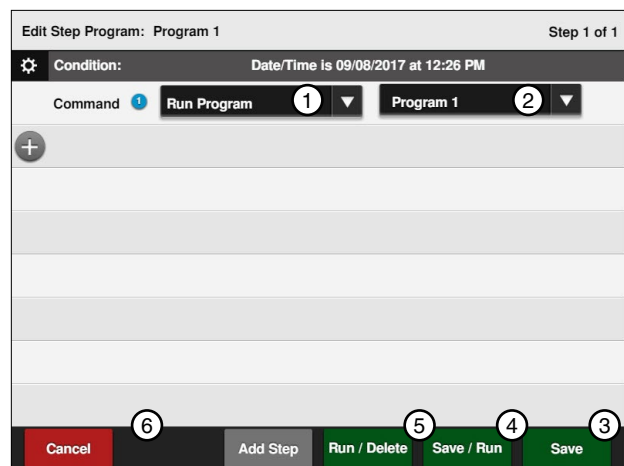

Figure 98-2 1. Choose Command 4. Save / Run
 2. Choose Program 5. Run / Delete
 3. Save 6. Cancel

Sample Step Program Design Form

The Step Program design form is a useful tool when you are planning your Step Program. It provides you with the ability to describe the conditions, commands, and options you want included in the program. Figure 99-1 below is an example of how the steps in Step Programming could each be mapped out and described.

STEP Program Number 2
 Field ID 004

4 AT 0°
STOP

1
START
08/08/16
3:00 am
WATER ON
1.00 INCHES
FORWARD

2 AT 180°
WATER OFF
PERCENT 100

3 AT 225°
WATER ON
0.75 INCHES

CONDITIONS	STEP 1	STEP 2	STEP 3	STEP 4	STEP 5	STEP 6	STEP 7	STEP 8	STEP 9
DATE / TIME	8/8/16 3am								
DAY / TIME									
POSITION		180°	225°	0°					
PRESSURE									
DELAY									
DIRECTION									
ANALOG									
MODULE									
PULSE RATE									
PULSE COUNT									
RAIN									
WIND									
FLOW									
TEMPERATURE									
DISPLAY IGNITION									
END GUN									
AUXILIARY									
REMOTE START									
PRESSURE SWITCH									
SPARE PTG									
SAFETY SENSE									
CABLE THEFT									
COMMANDS									
START/STOP	START			STOP					
DIRECTION FOR/REV	FORWARD								
WATER ON/OFF		OFF	ON						
DEPTH	1.00 IN		0.75 IN						
PERCENTAGE		100 %							
AUX 1 ON / OFF									
AUX 2 ON / OFF									
STOP-IN-SLOT ON/OFF									
RUN PROGRAM									
ARAS									
AUTO RESTART									
SET CYCLE									
% OF % ADJUST % TIMER									
% OF DEPTH, ADJUST DEPTH BY A %									
LOG EVENT									
VRI ON/OFF									
CRUISE CONTROL ON/OFF									
12 V POWER									
END-GUN 1, 2, 3, 4									

Figure 99-1

Programs / Step Programs

Write a New Program

To write a new Step Program, fill in a copy of the Step Program design form with conditions and commands for each step. Refer to the sample Step Program design form on the previous page. Blank forms are located in the Appendix. Using a completed design form, follow the steps below:

1. Push **Menu**, **Programs**, and **Step Programs** to view the Step Programs screen.
2. Push the **New Program** button corresponding to the preferred program number as shown in Figure 100-1.
3. Select the **Choose Condition** drop-down menu and choose a condition for this step. Refer to Figure 100-1.

Set the condition parameters as required for the selected programming condition.

4. Select the **Choose Command** drop-down menu and choose a command. Refer to Figure 100-1.

Set the command as required to turn on/off, enable/disable or enter a parameter for the selected programming condition.

Add up to 8 commands per step.

5. To add a step, push the Add Step button to add up to 9 steps and repeat steps 3 and 4.
6. To finish the program select one of the following.
 - Push **Save** to save the program.
 - Push **Save / Run** to save and then run the program.
 - Push **Run / Delete** to run the program once and then delete it.
 - Push **Cancel** to return to the main step program page.

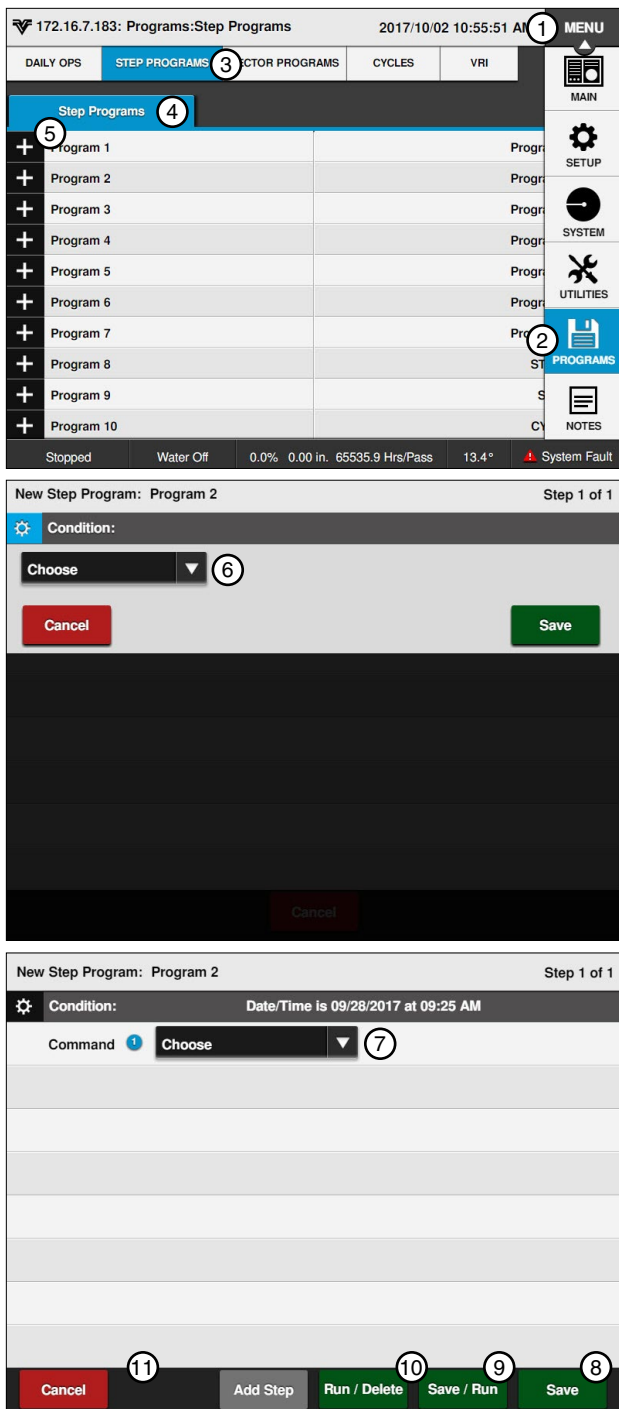

Figure 100-1 1. Menu 7. Choose Command
 2. Programs 8. Save
 3. Step Programs 9. Save / Run
 4. Step Programs 10. Save / Delete
 5. New Program 11. Cancel
 6. Choose Condition

Review or Edit a Step Program

Use edit to review or edit Step Programs that are stored in memory, running, or will be executed as soon as their conditions are met. All steps in a program can be reviewed while the program is running.

Using Edit

To review or edit a Step Program stored in memory, follow the steps below:

1. Push **Menu**, **Programs**, and **Step Programs** to view the Step Programs screen.
2. Push the **Settings** button corresponding to the preferred program number as shown in Figure 101-1.
3. Push the **Edit** button.
4. Edit the program step, if desired.
 - Select the Condition or Command drop-down menu to make changes.
 - Set or change the condition or command parameters as required or turn on/off, enable/disable.
 - To add a new step at the end of the program, push the **Add Step** button.
 - » Program the new step, selecting the programming condition and commands. Up to nine steps can be programmed.
5. When finished reviewing and if no changes were made, push the **Cancel** button. Refer to Figure 101-2.

If changes were made when reviewing select one of the following.

- Push **Save** to save the program.
- Push **Save / Run** to save and then run the program.
- Push **Run / Delete** to run the program once and then delete it.
- Push **Cancel** to return to the main step program page.

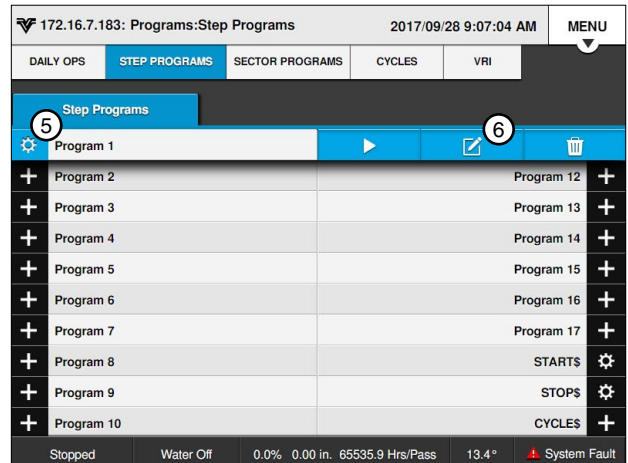
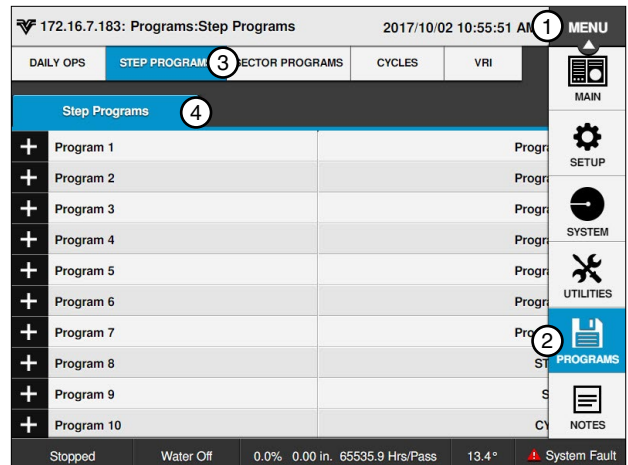

Figure 101-1 1. Menu 4. Step Programs
2. Programs 5. Settings
3. Step Programs 6. Edit

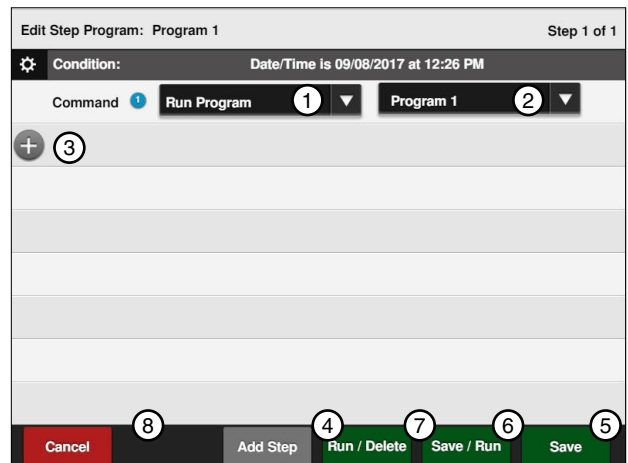

Figure 101-2 1. Choose Command 5. Save
2. Choose Program 6. Save / Run
3. Add Command 7. Run / Delete
4. Add Step 8. Cancel

Programs / Step Programs

Deleting a Step Program

To delete a Step Program stored in memory, follow the steps below:

1. Push **Menu**, **Programs**, and **Step Programs** to view the Step Programs screen.
2. Push the **Settings** button corresponding to the preferred program number as shown in Figure 102-1.
3. Push the **Delete** button.
4. When prompted with the Delete Step Program screen, push **OK** to finish deleting. Refer to Figure 102-1.
 - If this is not a program you want to delete, push the **Cancel** button.

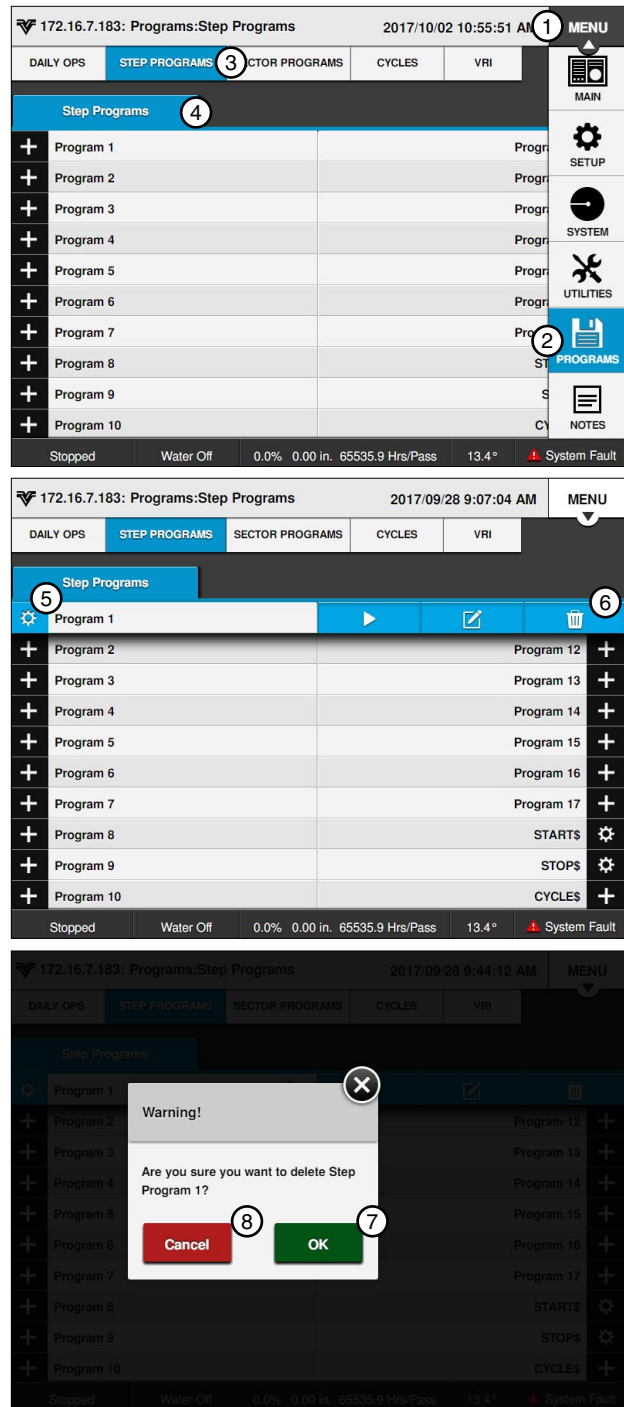

Figure 102-1 1. Menu 5. Settings
2. Programs 6. Delete
3. Step Programs 7. OK
4. Step Programs 8. Cancel

Programs / Step Program Examples

Step Programs

A program is a list of conditions and commands which need to occur in a specified order. The completed step program design form example below illustrates how to use the form to outline the following example program. Refer to Figure 103-1.

Sample Step Program Design Form

Current Conditions:

- Machine Off at 0°

Program Machine By:

- Date/Time: On 08/08/17, at 3:00 AM, Water On, Depth 1.00", Forward, Start
- Position: At 180°, Water Off, 100 percent
- Position: At 225°, Water On, Depth 0.75"
- Position: At 0°, Stop

The program design form has been filled out to reflect the example program. Follow these steps as a guide when thinking about programs you want to write.

1. Make a sketch of the field and identify what you want the irrigation machine to do.
2. Determine what must happen first. This is Step #1. (Ex. Start on 08/08/17 at 3:00 AM).
3. Identify the condition. Will Step #1 occur at a position in the field, a date/time, a specified time delay or other conditions? (Ex. 08/08/17 at 3:00 AM).
4. Identify what commands need to occur for Step #1. (Ex: Water On, 1.00 inch Depth, Forward, Start).
5. Determine conditions and commands for other steps.

NOTE: All steps are executed in sequential order.

If you complete the step program design form, it makes entering the program easy.

Just follow each column down and enter the correct information.

Blank step program design form is provided in the Appendix.

STEP Program Number 2

Field ID 004

CONDITIONS	STEP 1	STEP 2	STEP 3	STEP 4	STEP 5	STEP 6	STEP 7	STEP 8	STEP 9
DATE / TIME	8/8/16 3:00								
DAY / TIME									
POSITION		180°	225°	0°					
PRESSURE									
DELAY									
DIRECTION									
ANALOG									
MODULE									
PULSE RATE									
PULSE COUNT									
RAIN									
WIND									
FLOW									
TEMPERATURE									
DISPLAY IGNITION									
END GUN									
AUXILIARY									
REMOTE START									
PRESSURE SWITCH									
SPARE PTG									
SAFETY SENSE									
CABLE THEFT									
COMMANDS									
START/STOP	START			STOP					
DIRECTION FOR/REV	FORWARD								
WATER ON/OFF		OFF	ON						
DEPTH	1.00 IN		0.75 IN						
PERCENTAGE		100 %							
AUX 1 ON / OFF									
AUX 2 ON / OFF									
STOP-IN-SLOT ON/OFF									
RUN PROGRAM									
ARAS									
AUTO RESTART									
SET CYCLE									
% OF % ADJUST % TIMER									
% OF DEPTH, ADJUST DEPTH BY A %									
LOG EVENT									
VRI ON/OFF									
CRUISE CONTROL ON/OFF									
12 V POWER									
END-GUN 1, 2, 3, 4									

Figure 103-1

Programs / Step Program Examples

Example 1. Program by Date, Time, and Position

In this program example, the machine is being programmed to start on a specific date and time, water one half of the field, turn the water off, and increase speed over set aside acres. It then turns the water on, sets the depth, and waters the remaining half of the field, stopping at 0°. Refer to Figure 104-1.

Current Machine Condition:

- Machine Off at 0°

Program Machine By:

- Time: On 08/08/17 at 3:00 AM, Water On, Forward, Depth 1.00", Start
- Position: At 180°, Water Off, Percent 100
- Position: At 225°, Water On, Depth 0.75"
- Position: At 0°, Stop

Start Programming

To program Example 1 follow these steps:

1. Push **Menu**, **Programs**, and **Step Programs** to view the Step Programs screen.
2. Push the **New Program** button corresponding to the preferred program number as shown in Figure 104-2.

Program Step 1

3. To program the date and time condition for this step follow these steps:
 - a) Select the **Choose Condition** drop-down menu and choose **Date/Time**. Refer to Figure 104-2.
 - b) Select the **Date** field one at a time and choose 2017, 08, 08 for August 08, 2017, push **Enter** to retain the value.
 - c) Select the **Time** field one at a time and choose 03, 00 for 3:00 AM, push **Enter** to retain the value then push AM.
 - d) Push the **Save** button to retain the values for the Date/Time condition.

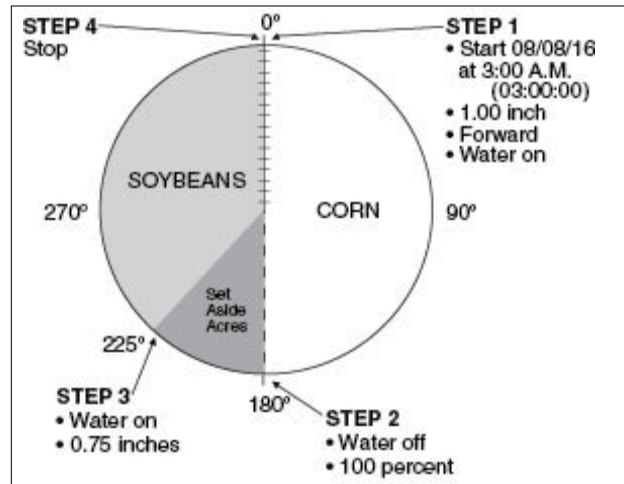

Figure 104-1

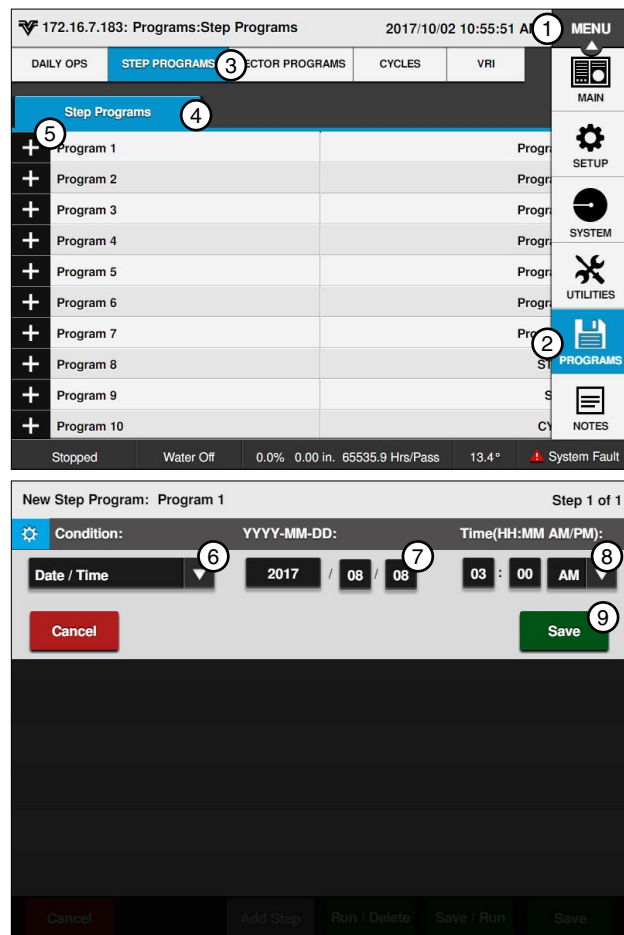

Figure 104-2 1. Menu 6. Date/Time
 2. Programs 7. Date
 3. Step Programs 8. Time
 4. Step Programs 9. Save
 5. New Program

Programs / Step Program Examples

Example 1. Program by Date, Time, and Position (Continued)

Program Step 1

4. Enter the commands to execute on 08/08/17 at 3:00 AM. Refer to Figures 105-1 through 105-2.
 - a) Select the **Choose Command** drop-down menu and choose **Water**.
 - b) Push the **On** button to set the command to **Water On**.
 - c) Select the **Add Command** drop-down menu and choose **Depth**.
 - d) Select the **Inches** field, enter **1, 0, 0** for 1.00 inches and push **Enter** to retain the value.
 - e) Select the **Add Command** drop-down menu and choose **Direction**.
 - f) Push the **Forward** button to set the command to **Forward**.
 - g) Select the **Add Command** drop-down menu and choose **Start/Stop**.
 - h) Push the **Start** button to set the command to **Start**.
 - i) Push **Add Step** to add step 2.

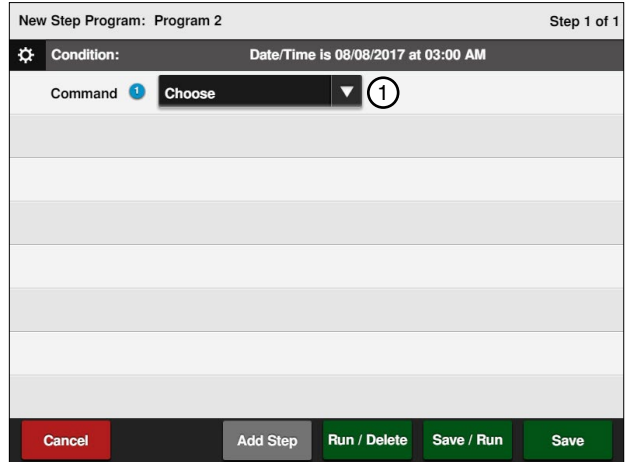

Figure 105-1 1. Choose Command Drop-Down

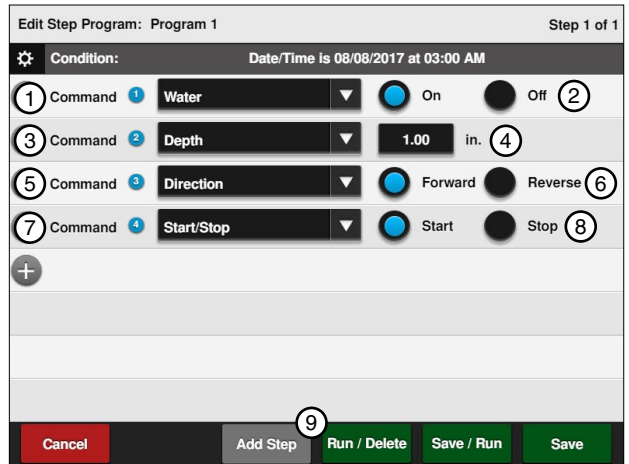

Figure 105-2 1. Water Command 6. Forward
2. Water On 7. Start/Stop Command
3. Depth Command 8. Start
4. Inches 9. Add Step
5. Direction Command

Programs / Step Program Examples

Example 1. Program by Date, Time, and Position (Continued)

Program Step 2

5. Program the position condition for this step. Refer to Figure 106-1.
 - a) Select the **Choose Condition** drop-down menu and choose **Position**.
 - b) Select the **Degrees** field, enter **1, 8, 0, 0** for 180.0 degrees and push **Enter**.
 - c) Push the **Save** button to retain the values for the Position condition.
6. Enter the commands to execute at this position. Refer to Figure 106-1.
 - a) Select the next **Choose Command** drop-down menu, choose **Water**, and use the default setting of Water Off.
 - b) Select the **Add Command** drop-down menu and choose **Percent**.
 - c) Select the **Percent** field, enter **1, 0, 0** for 100 percent, and push **Enter** to retain the value.
7. Push **Add Step** to add step 3.

Program Step 3

8. Program the position condition for this step. Refer to Figure 106-2.
 - a) Select the **Choose Condition** drop-down menu and choose **Position**.
 - b) Select the **Degrees** field, enter **2, 2, 5, 0** for 225.0 degrees, and push **Enter** to retain the value.
 - c) Push the **Save** button to retain the values for the Position condition.
9. Enter the commands to be executed at this position.
 - a) Select the **Choose Command** drop-down menu and choose **Water**.
 - b) Push the **On** button to set the command to Water On.
 - c) Select the **Add Command** drop-down menu and choose **Depth**.
 - d) Select the **Inches** field, enter **0, 7, 5** for 0.75 inches, and push **Enter** to retain the value.
10. Push **Add Step** to add step 4.

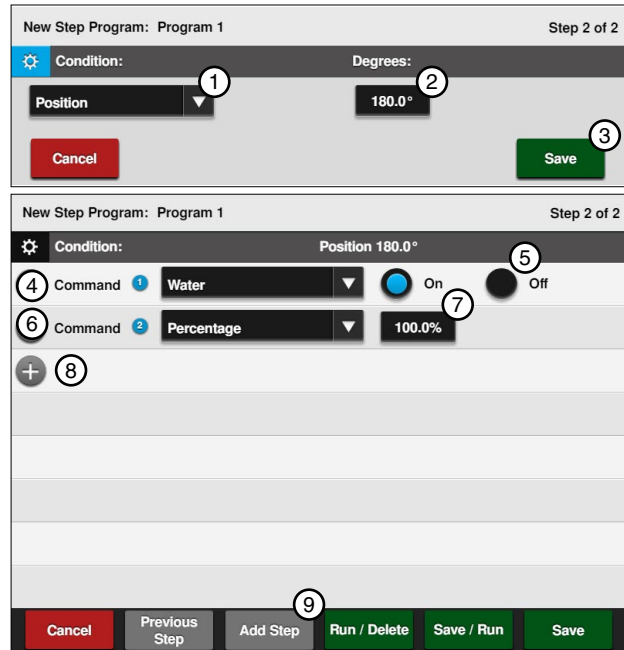

Figure 106-1 1. Position Condition 2. Degrees 3. Save 4. Water Command 5. Water OFF 6. Percent Command 7. Percent 8. Add Command 9. Add Step

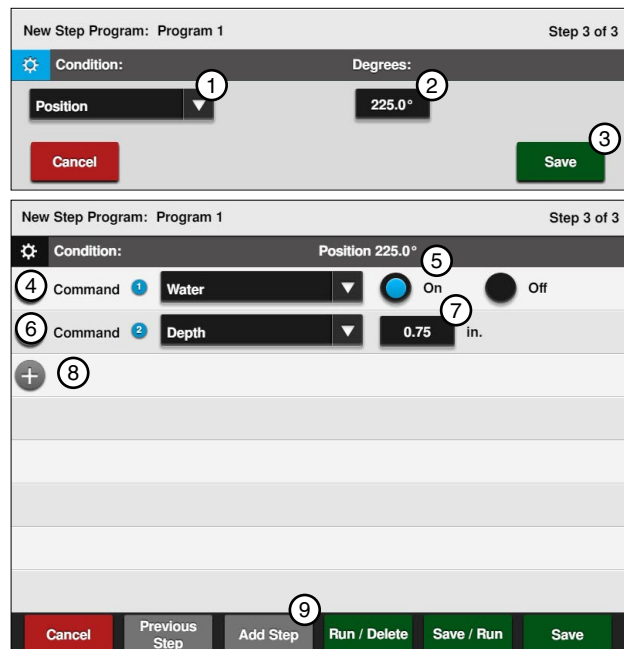

Figure 106-2 1. Position Condition 2. Degrees 3. Save 4. Water Command 5. Water ON 6. Depth Command 7. Inches 8. Add Command 9. Add Step

Example 1. Program by Date, Time, and Position (Continued)

Program Step 4

11. Program the position condition for this step. Refer to Figure 107-1.
 - a) Select the **Choose Condition** drop-down menu.
 - b) Choose **Position** as the condition for this step and use the default setting of **0.0** degrees.
 - c) Push the **Save** button to retain the values for the Position condition.
12. Enter the command to be executed at this position. Refer to Figure 107-1.
 - a) Select the **Choose Command** drop-down menu, choose **Start/Stop**, and use the default setting of **Stop**.

Finish Programming

13. Finish the program by selecting one of the following. Refer to Figure 107-1.
 - Push **Save** to save the program.
 - Push **Save / Run** to save and then run the program.
 - Push **Run / Delete** to run the program once and then delete it.
 - Push **Cancel** to return to the main step program screen.

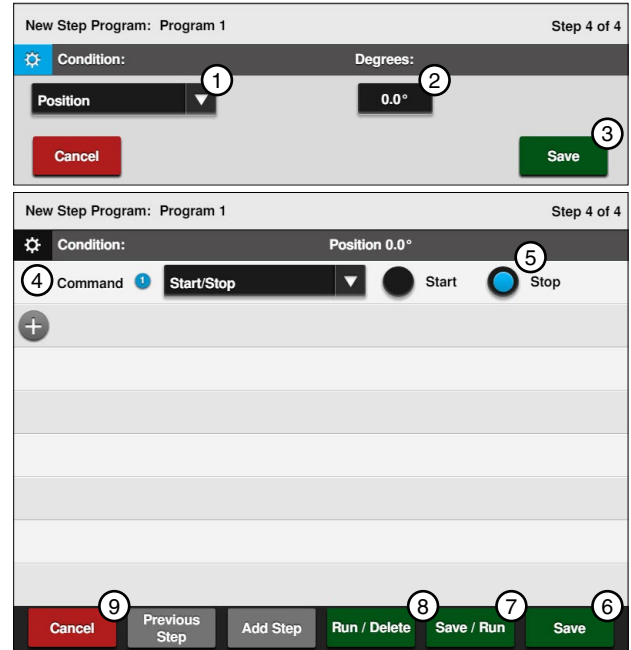

Figure 107-1

1. Position Condition	6. Save
2. Degrees	7. Save / Run
3. Save	8. Save / Delete
4. Start/Stop Command	9. Cancel
5. Stop	

Programs / Step Program Examples

Example 2. Program by Day and Time

In this program example, the machine is being programmed to start on specific days and time, water one half of the field, turn the water off, and increase speed over set aside acres. It then turns the water on, sets the depth, and waters the remaining half of the field, stopping at 0°. Refer to Figure 108-1.

Current Machine Condition:

- Machine Off at 0°

Program Machine By:

- Day and Time: On Mondays, Wednesdays, and Fridays at 3:00 AM, Water On, Forward, Depth 1.00", Start
- Position: At 180°, Water Off, Percent 100
- Position: At 225°, Water On, Depth 0.75"
- Position: At 0°, Stop

Start Programming

To program Example 2 follow these steps:

1. Push **Menu**, **Programs**, and **Step Programs** to view the Step Programs screen.
2. Push the **New Program** button corresponding to the preferred program number as shown in Figure 108-2.

Program Step 1

3. Program the day and time for this step. Refer to Figure 108-2.
 - a) Select the **Choose Condition** drop-down menu and choose **Day/Time**.
 - b) Select the days by pushing the **Configure Days** button and checking the **Monday**, **Wednesday** and **Friday** checkboxes.
 - c) Select the **HH/MM Time** field one at a time and choose 3, 00 for 3:00 AM, then push **Enter** to retain the value.
 - d) Push the **Save** button to retain the values for the Day/Time condition.

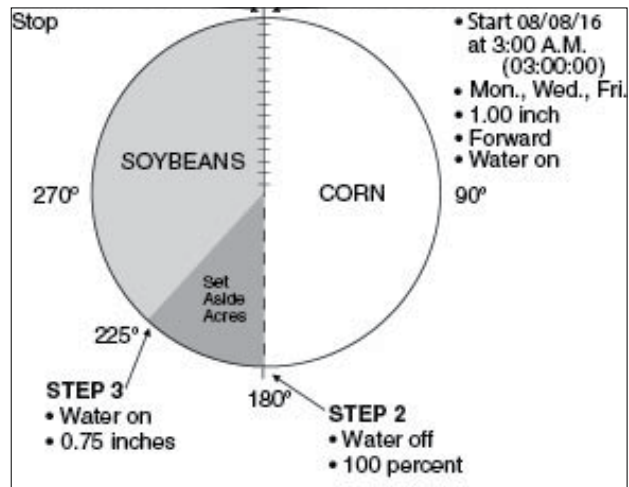

Figure 108-1

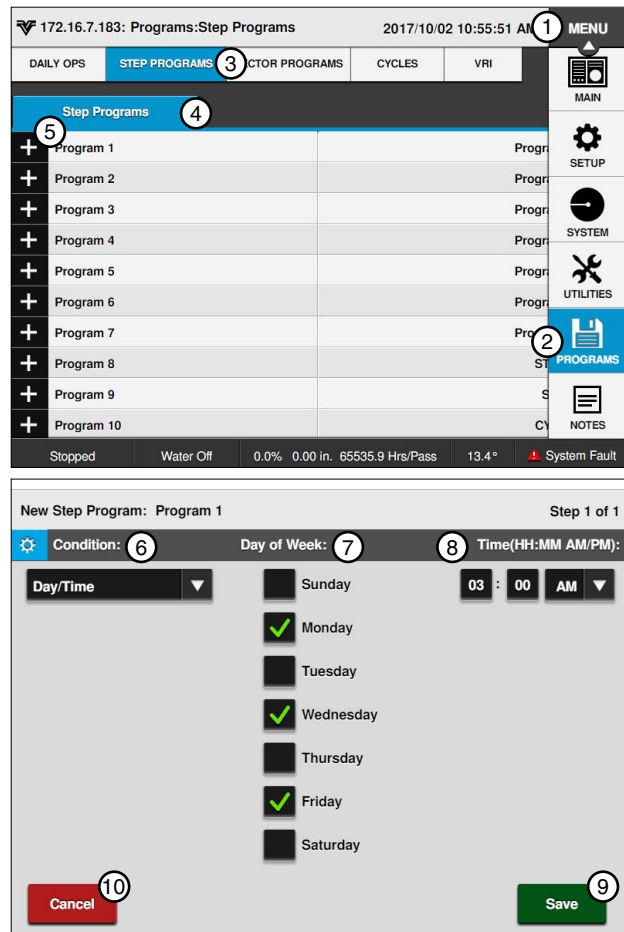

Figure 108-2 1. Menu 2. Programs 3. Step Programs 4. Step Programs 5. New Program 6. Condition 7. Day of Week 8. Time 9. Save 10. Cancel

Example 2. Program by Day and Time (Continued)

4. Enter the commands to execute on Mondays, Wednesdays, and Fridays at 3:00 AM. Refer to Figure 109-1.
 - a) Select the **Choose Command** drop-down menu and choose **Water**.
 - b) Push the **On** button to set the command to **Water On**.
 - c) Select the **Add Command** drop-down menu and choose **Direction**.
 - d) Push the **Forward** button to set the command to **Forward**.
 - e) Select the **Add Command** drop-down menu and choose **Depth**.
 - f) Select the **Inches** field, enter **1, 0, 0** for 1.00 inches, and push **Enter**.
 - g) Select the **Add Command** drop-down menu and choose **Start/Stop**.
 - h) Push the **Start** button to set the command to **Start**.
 - i) Push the **Add Step** button to add step 2.

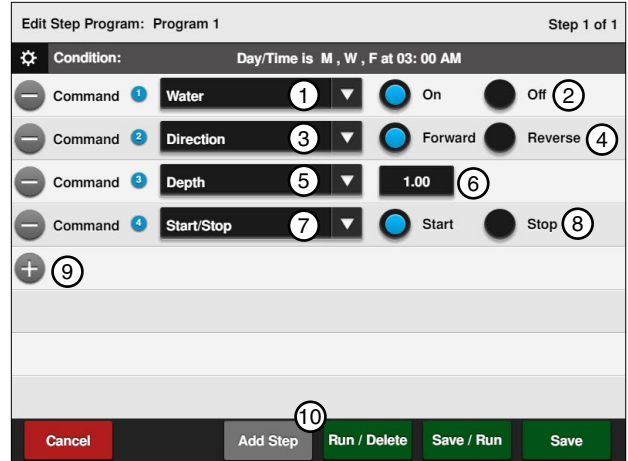

Figure 109-1 1. Water Command 6. Inches
 2. Water ON 7. Start/Stop Command
 3. Direction Command 8. Start
 4. Forward 9. Add Command
 5. Depth 10. Add Step

Program Step 2

5. Program the position condition for this step. Refer to Figure 109-2.
 - a) Select the **Choose Condition** drop-down menu and choose **Position**.
 - b) Select the **Degrees** field, enter **1, 8, 0, 0** for 180.0 degrees, and push **Enter** to retain the value.
 - c) Push the **Save** button to retain the values for the Position condition.
6. Enter the commands to be executed at this position. Each command appears on the screen when entered. Refer to Figure 109-3.
 - a) Select the **Choose Command** drop-down menu, choose **Water**, and use the default setting of **Water Off**.
 - b) Select the **Add Command** drop-down menu and choose **Percent**.
 - c) Select the **Percent** field, enter **1, 0, 0** for 100 percent and push **Enter** to retain the value.
7. Push **Add Step** button to add step 3.

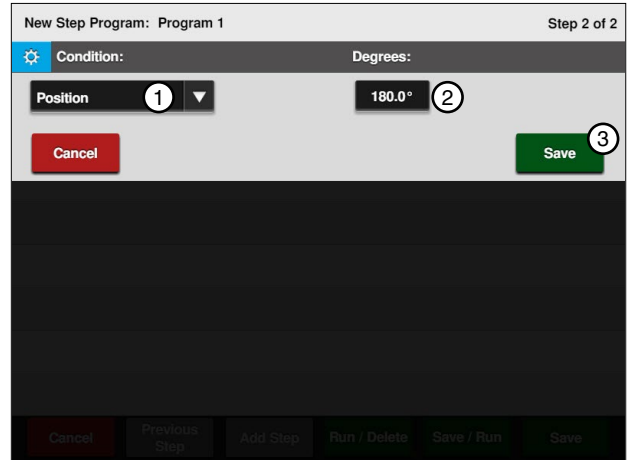

Figure 109-2 1. Condition 3. Save
 2. Degrees

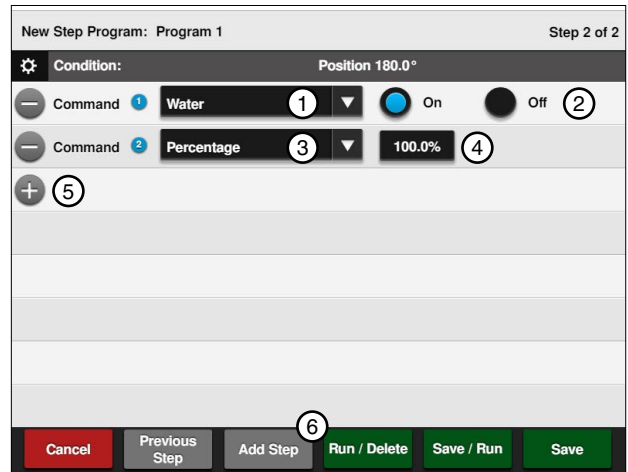

Figure 109-3 1. Water Command 4. Percent
 2. Water Off 5. Add Command
 3. Percent Command 6. Add Step

Programs / Step Program Examples

Example 2. Program by Day and Time (Continued)

Program Step 3

8. Program the position condition for this step. Refer to Figure 110-1.
 - a) Select the **Choose Condition** drop-down menu and choose **Position**.
 - b) Select the **Degrees** field, enter **2, 2, 5, 0** for 225.0 degrees, and push Enter.
 - c) Push the **Save** button to retain the values for the Position condition.
9. Enter the commands to be executed at this position. Refer to Figure 110-2.
 - a) Select the **Choose Command** drop-down menu and choose **Water**.
 - b) Push the **On** button to set the command to **Water On**.
 - c) Select the **Add Command** drop-down menu and choose **Depth**.
 - d) Select the **Inches** field, enter **0, 7, 5** for 0.75 inches, and push **Enter** to retain the value.
10. Push **Add Step** to add step 4.

Program Step 4

11. Program the position condition for this step. Refer to Figure 110-3.
 - a) Select the **Choose Condition** drop-down menu and choose **Position**.
 - b) Use the default setting of **0.0** degrees.
 - c) Push the **Save** button to retain the values for the Position condition.
12. Enter the command to be executed at this position. Refer to Figure 110-4.
 - a) Select the **Choose Command** drop-down menu and choose **Start/Stop**.
 - b) Use the default setting of **Stop**.

Finish Programming

13. Finish the program by selecting one of the following. Refer to Figure 110-4.
 - Push **Save** to save the program.
 - Push **Save / Run** to save and then run the program.
 - Push **Run / Delete** to run the program once and then delete it.
 - Push **Cancel** to return to the main step program screen.

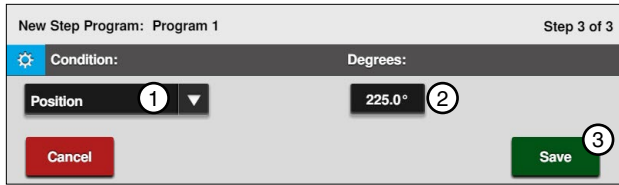

Figure 110-1 1. Condition 2. Degrees 3. Save

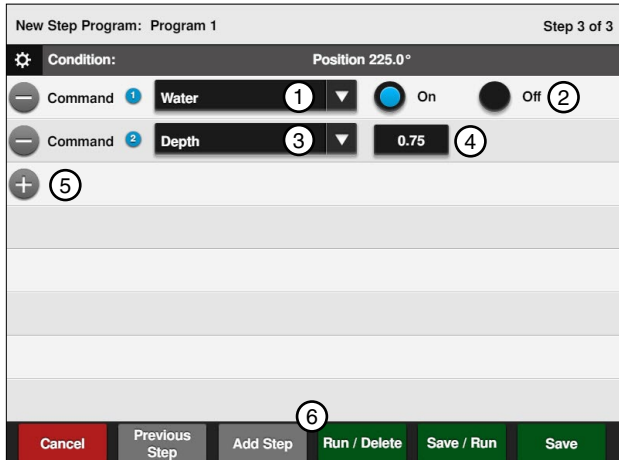

Figure 110-2 1. Water Command 2. Water ON 3. Depth 4. Inches 5. Add Command 6. Add Step

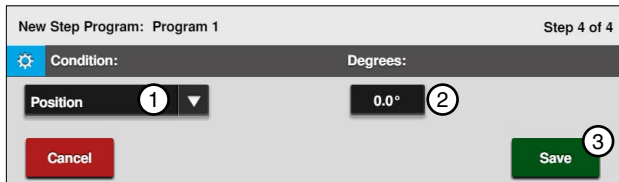

Figure 110-3 1. Condition 2. Degrees 3. Save

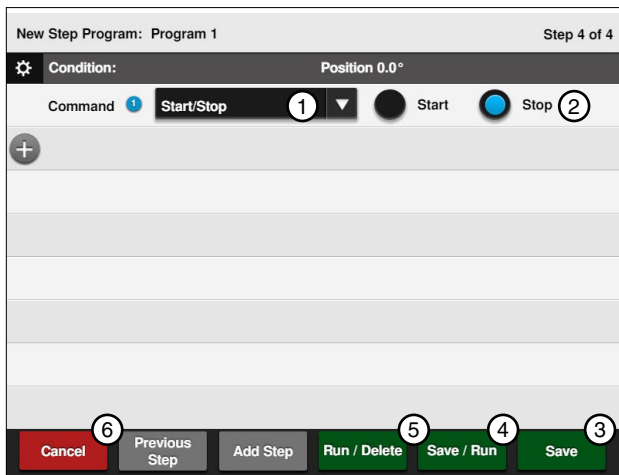

Figure 110-4 1. Start/Stop Command 2. Stop 3. Save 4. Save / Run 5. Run / Delete 6. Cancel

Programs / Step Program Examples

Example 3. Program by Date/Time and Position with SIS On

In this programming example, the machine is programmed to start at a specific date and time. Water one quarter of the field, turn AUX1 on and increase speed over one half of the field, then turn AUX1 off, slow down and SIS on to water the remaining quarter of the field. The SIS is set at 90°. Refer to Figure 111-1.

Current Conditions:

- Machine Off at 90°
- SIS is on and set at 90°

Program Machine By:

- Date/Time: On 08/08/17 at 3:00 AM, Water On, Forward, Depth 1.00", Start
- Position: At 180°, Aux1 On, Percent 100
- Position: At 0°, Aux1 Off, Depth to 0.75"

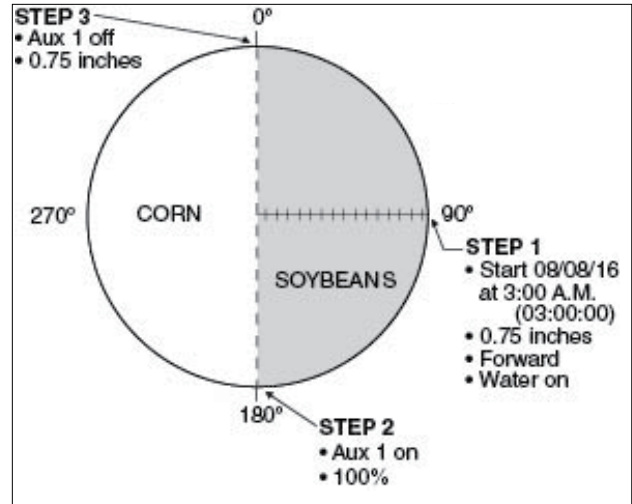

Figure 111-1

Start Programming

To program Example 3 follow these steps:

1. Push **Menu**, **Programs**, and **Step Programs** to view the Step Programs screen. Refer to Figure 111-2.
2. Push the **New Program** button corresponding to the preferred program number as shown in Figure 111-2.

Program Step 1

3. Program the start time on a date and time. Refer to Figure 111-2.
 - a) Select the **Choose Condition** drop-down menu and choose **Date/Time**.
 - b) Select the **Date (MM/DD/YY)** field and enter 08, 08, 17 for August 08, 2017, then push **Enter** to retain the value.
 - c) Select the **Time (HH:MM)** field one at a time and enter 03, 00, for 3:00 AM, then push **Enter** to retain the value.
 - d) Push the **Save** button to retain the values for the Date/Time condition.

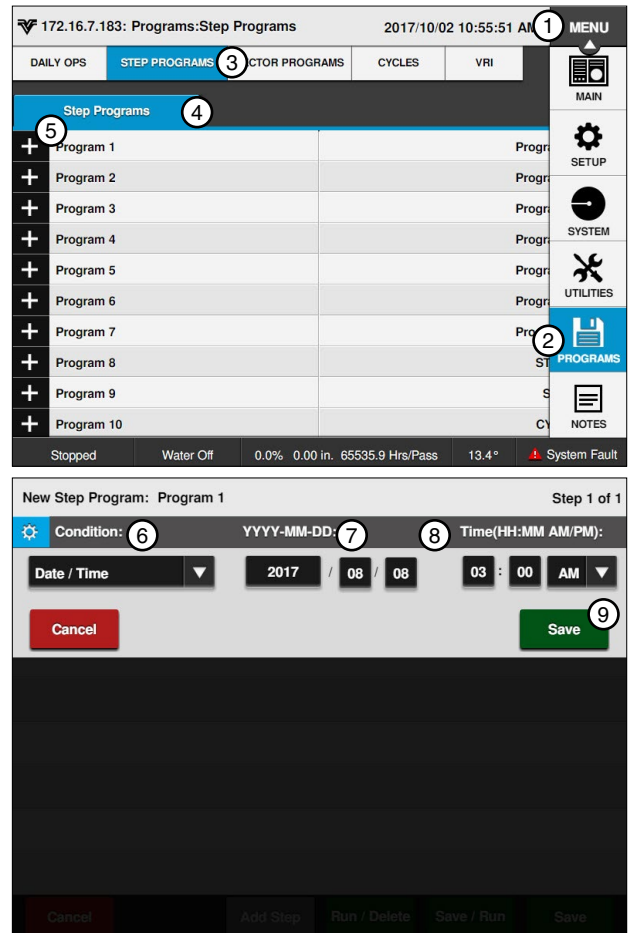

Figure 111-2

1. Menu	6. Condition
2. Programs	7. Day of Week
3. Step Programs	8. Time
4. Step Programs	9. Save
5. New Program	

Programs / Step Program Examples

Example 3. Program by Date/Time and Position with SIS On (Continued)

4. Enter the commands to execute on 2017/08/08 at 3:00 AM. Refer to Figure 112-1.
 - a) Select the **Add Command** drop-down menu and choose **Water**.
 - b) Push the **On** button to set the command to Water On.
 - c) Select the **Add Command** drop-down menu and choose **Depth**.
 - d) Select the **Inches** field, enter **1, 0, 0** for 1.00 inches, and push **Enter**.
 - e) Select the **Add Command** drop-down menu and choose **Direction**.
 - f) Push the **Forward** button to set the command to **Forward**.
 - g) Select the next **Add Command** drop-down menu and choose **Start/Stop**.
 - h) Push the **Start** button to set the command to **Start**.
 - i) Push **Add Step** to add step 2.

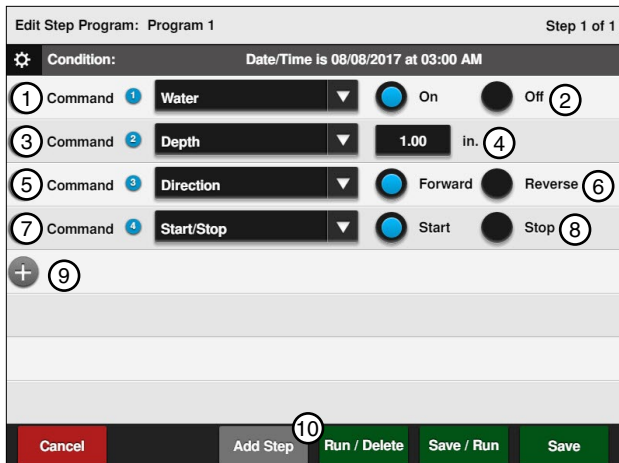

Figure 112-1 1. Depth Command 2. Depth 3. Water Command 4. Water On 5. Direction Command 6. Forward Direction 7. Start/Stop Command 8. Start 9. Add Command 10. Add Step

Program Step 2

5. Program the position condition for this step. Refer to Figure 112-2.
 - a) Select the **Choose Condition** drop-down menu and choose **Position**.
 - b) Select the **Degrees** field, enter **1, 8, 0, 0** for 180.0 degrees, and push **Enter**.
 - c) Push the **Save** button to retain the values for the Position condition.
6. Enter the commands to be executed at this position. Each command appears on the screen when entered. Refer to Figure 112-3.
 - a) Select the next **Add Command** drop-down menu and choose **Percent**.
 - b) Select the **Percent** field, enter **1, 0, 0** for 100 percent, and push **Enter**.
 - c) Select the **Choose Command** drop-down menu and choose **Aux 1**.
 - d) Push the **On** button to turn Aux 1 on.
 - e) Push **Add Step** to add step 3.

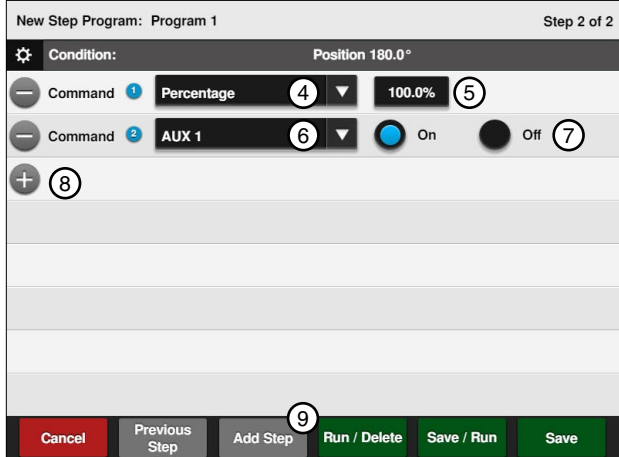
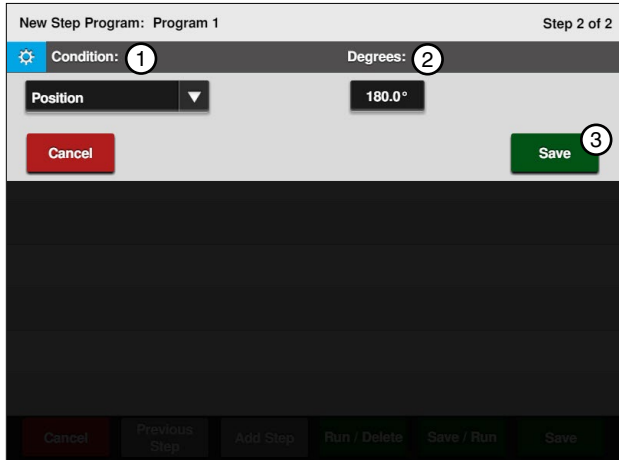

Figure 112-2 1. Condition 2. Degrees 3. Save 4. Percent Command 5. Percent 6. Aux 1 Command 7. Aux 1 On 8. Add Command 9. Add Step

Example 3. Program by Date/Time and Position with SIS On (Continued)

Program Step 3

7. Program the position condition for this step. Refer to Figure 113-1.
 - a) Select the **Choose Condition** drop-down menu, choose **Position**.
 - b) Use the default setting of **0.0** degrees in the **Degrees** field.
 - c) Push the **Save** button to retain the values for the Position condition.
8. Enter the commands to be executed at this position.
 - a) Select the **Add Command** drop-down menu, choose **Aux 1**.
 - b) Push the **Off** button to turn Aux 1 off.
 - c) Select the next **Add Command** drop-down menu and choose **Depth**.
 - d) Select the **Inches** field, enter **7, 5** for 0.75 inches and push **Enter** to retain the value.
 - e) Select the next **Add Command** drop-down menu and choose **Stop In Slot**.
 - f) Push the **On** button to turn Stop-In-Slot (SIS) on. The SIS position is set on the Main screen.

Finish Programming

9. Finish the program by selecting one of the following. Refer to Figure 113-1.
 - Push **Save** to save the program.
 - Push **Save / Run** to save and then run the program.
 - Push **Run / Delete** to run the program once and then delete it.
 - Push **Cancel** to return to the main step program screen.

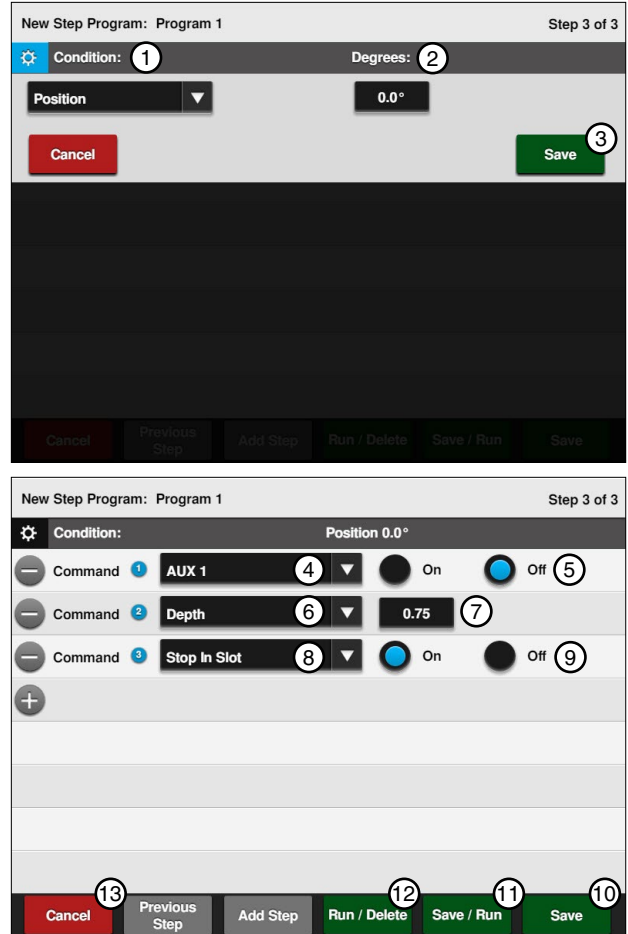

Figure 113-1

1. Condition	8. Stop-In-Slot Command
2. Degrees	9. Stop-In-Slot Off
3. Save	10. Save
4. Aux1 Command	11. Save / Run
5. Aux1 Off	12. Run / Delete
6. Depth Command	13. Cancel
7. Depth	

Programs / Step Program Examples

Example 4. Program by Pressure

In this example, the machine is programmed by pressure to compensate for reduced flow rate/low pressure due to draw-down of the well. The program must be loaded with the pressure reading on the screen greater than 25 PSI, otherwise the program executes immediately as soon as it is run. The program runs only one time. If the pressure returns to 33 PSI, the machine still continues to run at 44 percent. A second program can be created that looks for a pressure higher than 30 PSI and sets the machine back to 50 percent.

Several variables are involved when trying to determine an adjustment to machine speed based on the operating pressure. Several of these include field elevations and the use of pressure regulators. Valmont Irrigation is not responsible for a degradation of water uniformity caused by adjusting the speed of the machine based on pressure readings at the pivot. Contact your local Valley dealer for further information regarding this subject.

Current Conditions:

- Machine is operating at 33 PSI water pressure
- After 4-5 hours, the draw-down of the well increases, causing the pressure to drop approximately 8 PSI

Program Machine By:

- Pressure: when the pressure drops below 25 PSI, set the percent to 44, this may help compensate for the reduced flow rate due to a drop in pressure

Start Programming

To program Example 6 follow these steps:

1. Push **Menu**, **Programs**, and **Step Programs** to view the Step Programs screen.
2. Push the **New Program** button corresponding to the preferred program number as shown in Figure 114-1.

Program Step 1

3. Program the pressure condition for this step. Refer to Figure 114-2.
 - a) Select the **Choose Condition** drop-down menu and choose **Pressure**.
 - b) Push the **Lower** button to set the condition to **Lower**.
 - c) Select the **PSI** field, enter **2, 5** for 25 PSI, and push **Enter** to retain the value.
 - d) Push the **Save** button to retain the values for the Pressure condition.

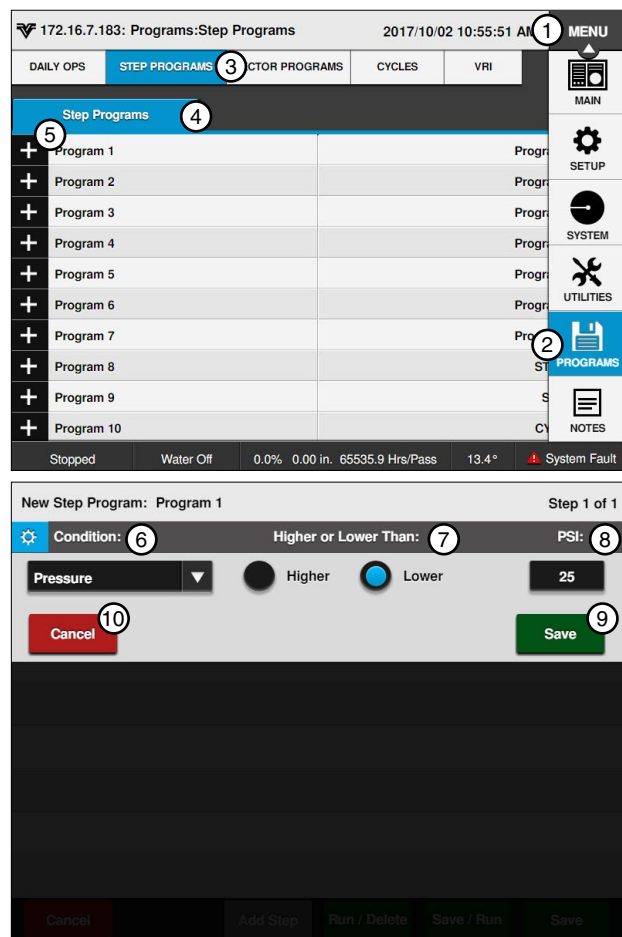

Figure 114-1 1. Menu
2. Programs
3. Step Programs
4. Step Programs
5. New Program
6. Condition
7. Day of Week
8. Time
9. Save
10. Cancel

Example 4. Program by Pressure (Continued)

Program Step 1 (Continued)

4. Enter the command to be executed when the water pressure drops below 25 PSI. Refer to Figures 115-1.
 - a) Select the **Choose Command** drop-down menu and choose **Percent**.
 - b) Select the **Percent** field and enter **4, 4** for 44 percent and push **Enter** to retain the value.

Finish Programming

5. Finish the program by selecting one of the following. Refer to Figure 115-1.
 - Push **Save** to save the program.
 - Push **Save / Run** to save and then run the program.
 - Push **Run / Delete** to run the program once and then delete it.
 - Push **Cancel** to return to the main step program screen.

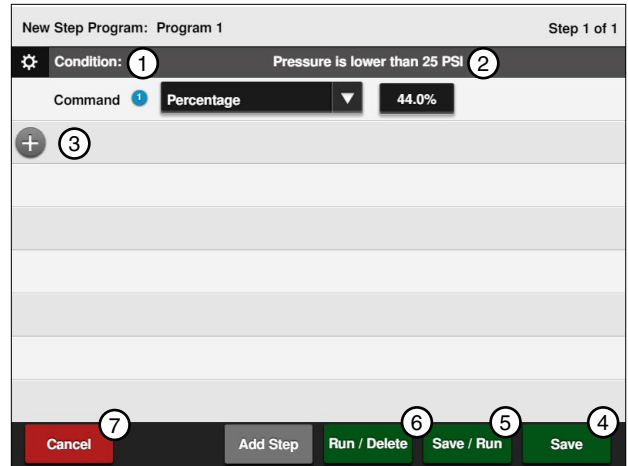

Figure 115-1 1. Percent Condition 5. Save / Run
2. PSI 6. Run / Delete
3. Add Command 7. Cancel
4. Save

Programs / Step Program Examples

Example 5. Program with Percent-of-Percent Timer or Percent-of-Depth

In this example, the Percent Timer will be programmed to 50% of its current setting when the wind speed exceeds 20 mph. This action is not dependent on such things as direction, position, time of day, etc. As a result of this program, when the wind speed reaches 20 mph the Percent Timer will be adjusted from 60% to 30%.

Current Conditions:

- Machine Running, 60%, Water On

Program Machine By:

- Wind speed equal to or greater than 20 mph - 50% of 60%

Start Programming

To program Example 7 follow these steps:

1. Push **Menu**, **Programs**, and **Step Programs** to view the Step Programs screen.
2. Push the **New Program** button corresponding to the preferred program number as shown in Figure 116-1.

Program Step 1

3. To program using the Wind condition. Refer to Figure 116-1.
 - a) Select the **Choose Condition** drop-down menu and choose **Wind**.
 - b) Push the **Higher** button to set the condition to **Higher**.
 - c) Select the **MPH** field, enter **2, 0** for 20 MPH wind speed, and push **Enter** to retain the value.
 - d) Push the **Save** button to retain the values for the Wind condition.
4. Enter the command to be executed when wind speed is higher than 20 mph. Refer to Figure 116-1.
 - a) Select the **Choose Command** drop-down menu and choose **% of % Timer**.

NOTE: You can alternately choose to specify a percent of the depth setting by choosing % of Depth (percent of depth).

- b) Select the **Percent** field, enter **5, 0** for 50 percent and push **Enter** to retain the value.

Finish Programming

5. Finish the program by selecting one of the following. Refer to Figure 116-2.
 - Push **Save** to save the program.
 - Push **Save / Run** to save and then run the program.
 - Push **Run / Delete** to run the program once and then delete it.
 - Push **Cancel** to return to the main step program screen.

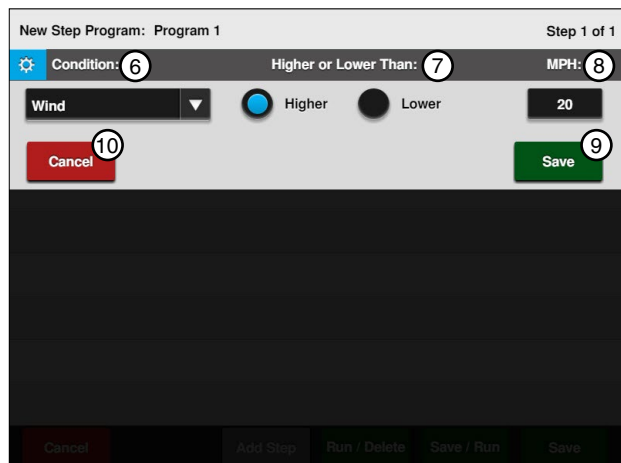
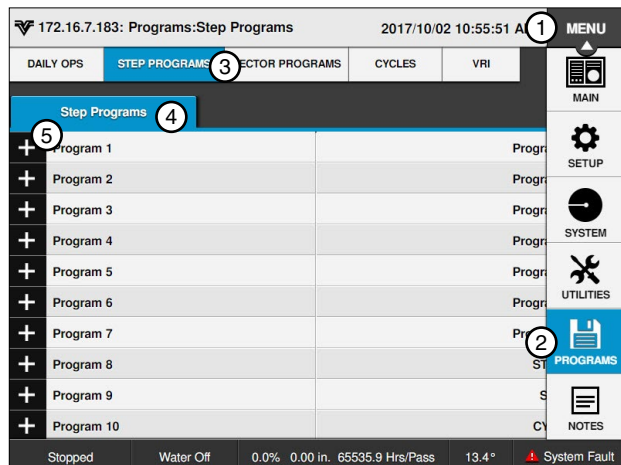

Figure 116-1 1. Menu
2. Programs
3. Step Programs
4. Step Programs
5. New Program
6. Condition
7. Higher Than
8. MPH
9. Save
10. Cancel

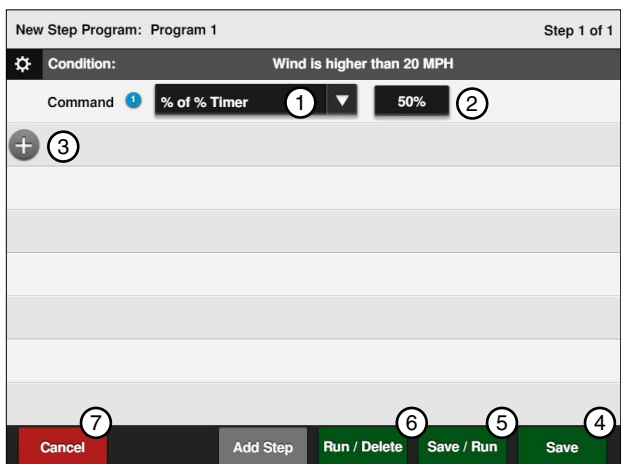

Figure 116-2 1. % of % Timer Command
2. Percent
3. Add Command
4. Save
5. Save / Run
6. Run / Delete
7. Cancel

Programs / Step Program Examples

Example 6. Program with Enable/Disable End Guns

In this example, the end gun will be disabled when the wind speed exceeds 20 mph. This action is not dependent on such things as direction, position, time of day, etc.

Current Conditions:

- Machine Running, Water On, End Gun Enabled

Program Machine By:

- Wind speed equal to or greater than 20 mph - End Gun Disabled

Start Programming

To program Example 8 follow these steps:

1. Push **Menu**, **Programs**, and **Step Programs** to view the Step Programs screen.
2. Push the **New Program** button corresponding to the preferred program number as shown in Figure 117-1.

Program Step 1

3. To program using the wind condition to enable/disable the End Gun. Refer to Figure 117-1.
 - a) Select the **Choose Condition** drop-down menu and choose **Wind**.
 - b) Push the **Higher** button to set the condition to **Higher**.
 - c) Select the **MPH** field, enter **2, 0** for 20 MPH Wind Speed, and push **Enter** to retain the value.
 - d) Push the **Save** button to retain the values for the Wind condition.
4. Enter the command to be executed when wind speed is higher than 20 mph. Refer to Figure 117-2.
 - a) Select the **Choose Command** drop-down menu and choose **End Gun 1** for End Gun 1.
 - b) Use the default setting of **Off**.

NOTE

- You can alternately choose to enable/disable End Gun 2, End Gun 3, and End Gun 4.

Finish Programming

5. Finish the program by selecting one of the following. Refer to Figure 117-2.
 - Push **Save** to save the program.
 - Push **Save / Run** to save and then run the program.
 - Push **Run / Delete** to run the program once and then delete it.
 - Push **Cancel** to return to the main step program screen.

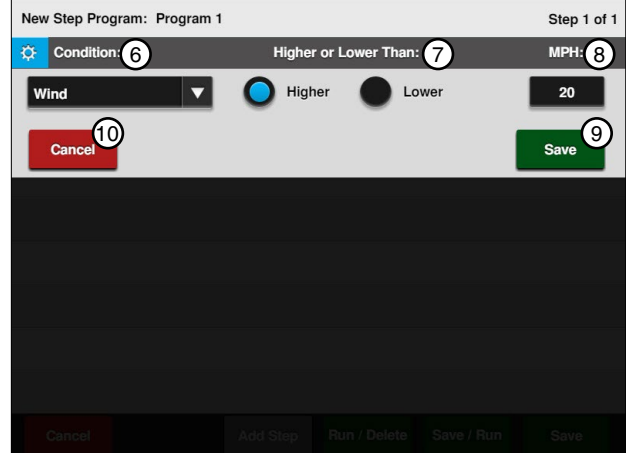
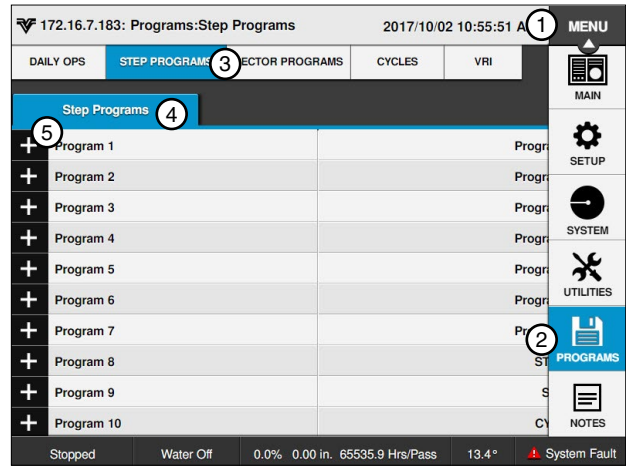

Figure 117-1 1. Menu
2. Programs
3. Step Programs
4. Step Programs
5. Add New Program
6. Wind Condition
7. Higher Than
8. MPH
9. Save
10. Cancel

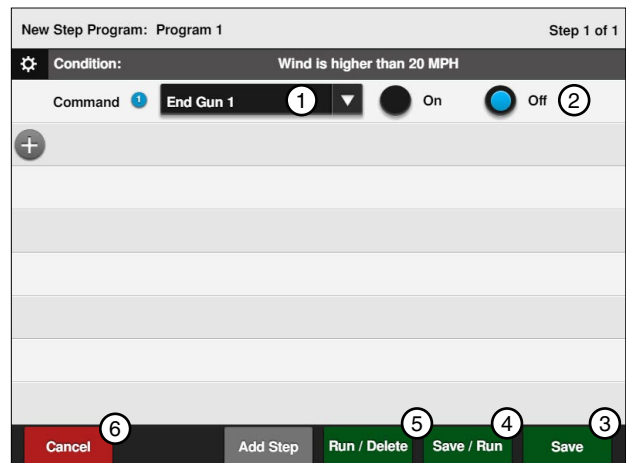

Figure 117-2 1. End Gun 1 Command
2. End Gun 1 Off
3. Save
4. Save / Run
5. Run / Delete
6. Cancel

Programs / Step Program Examples

Example 7. Program with Enable Cruise Control

In this example, the Cruise Control hours will be increased when the wind speed exceeds 20 mph. This action is not dependent on such things as direction, position, time of day, etc.

Current Conditions:

- Machine Running, Water On, Cruise Control set at 48 hours

Program Machine By:

- Wind speed equal to or greater than 20 mph - Cruise Control set at 72 hours

NOTE

- When Cruise Control is enabled, VRI is automatically turned off.

Start Programming

To program Example 9 follow these steps:

1. Push **Menu**, **Programs**, and **Step Programs** to view the Step Programs screen.
2. Push the **New Program** button corresponding to the preferred program number as shown in Figure 118-1.

Program Step 1

3. To program using the wind condition to enable/disable Cruise Control follow these steps:
 - a) Select the **Choose Condition** drop-down menu and choose **Wind**.
 - b) Push the **Higher** button to set the condition to **Higher**.
 - c) Select the **MPH** field, enter **2, 0** for 20 MPH Wind Speed, and push **Enter** to retain the value.
 - d) Push the **Update** button to retain the values for the Wind condition.
4. Enter the command to be executed when wind speed is higher than 20 mph. Refer to Figure 118-2.
 - a) Select the **Choose Command** drop-down menu and choose **Cruise Control On**.
 - b) Select the **Hrs/Pass** field and enter **7, 2, 0** for 72.0 hours per revolution and push **Enter** to retain the value.

Finish Programming

5. Finish the program by selecting one of the following. Refer to Figure 118-2.
 - Push **Save** to save the program.
 - Push **Save / Run** to save and then run the program.
 - Push **Run / Delete** to run the program once and then delete it.
 - Push **Cancel** to return to the main step program screen.

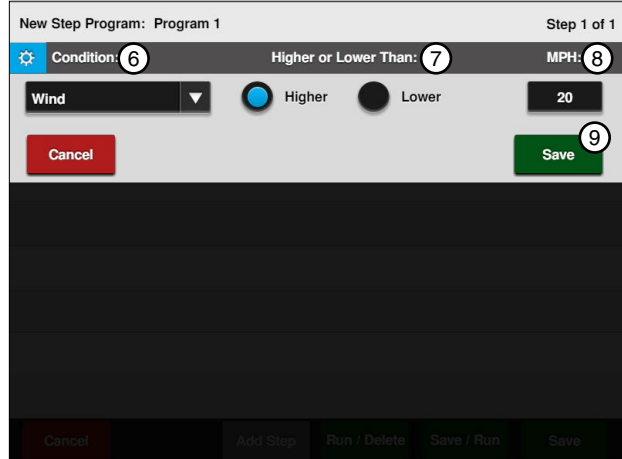
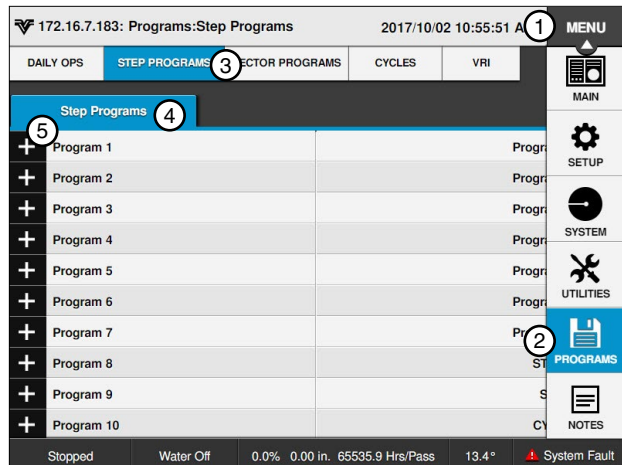

Figure 118-1 1. Menu
2. Programs
3. Step Programs
4. Step Programs
5. Add New Program
6. Wind Condition
7. Higher Than
8. MPH
9. Update

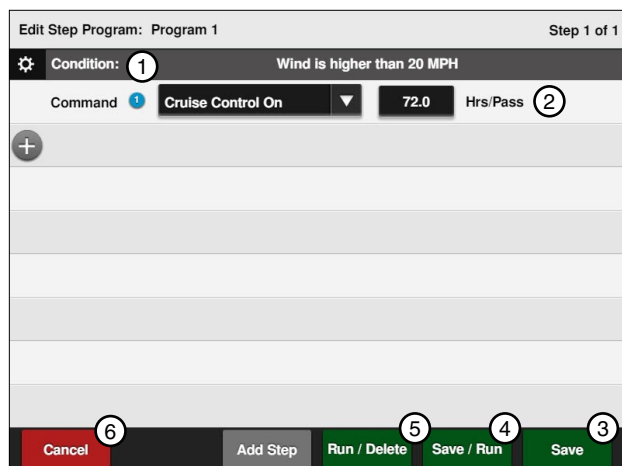

Figure 118-2 1. Cruise Control On
2. Hrs/Pass
3. Save
4. Save / Run
5. Run / Delete
6. Cancel

Example 8. Program for a Logging Event

In this example, when the wind speed exceeds 25 mph, an entry will be made in the event log and displayed on the History Review screens.

Program Machine By:

- Wind speed equal to or greater than 25 mph

Start Programming

To program Example 11 follow these steps:

1. Push **Menu**, **Programs**, and **Step Programs** to view the Step Programs screen.
2. Push the **New Program** button corresponding to the preferred program number as shown in Figure 119-1.

Program Step 1

3. To program using the wind condition to initiate a logging event follow these steps:
 - a) Select the **Choose Condition** drop-down menu and choose **Wind**.
 - b) Push the **Higher** button to set the condition to **Higher**.
 - c) Select the **MPH** field, enter **2, 5** for 25 MPH Wind Speed, and push **Enter** to retain the value.
 - d) Push the **Save** button to retain the values for the Wind condition.
4. Enter the command to be executed when wind speed is higher than 25 mph. Refer to Figure 119-2.
 - a) Select the **Choose Command** drop-down menu and choose **Log Event**.

Finish Programming

5. Finish the program by selecting one of the following. Refer to Figure 119-2.
 - Push **Save** to save the program.
 - Push **Save / Run** to save and then run the program.
 - Push **Run / Delete** to run the program once and then delete it.
 - Push **Cancel** to return to the main step program screen.

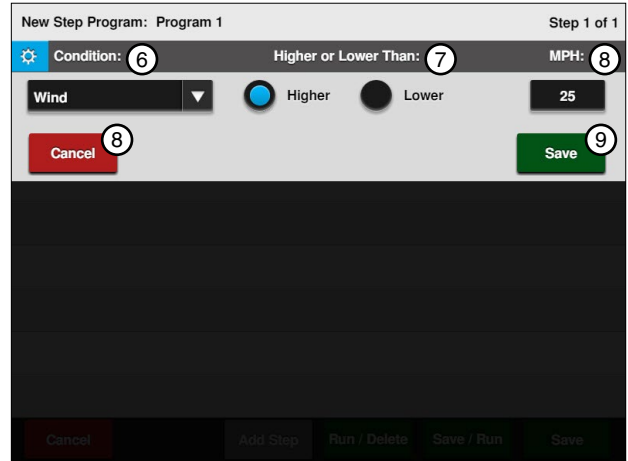
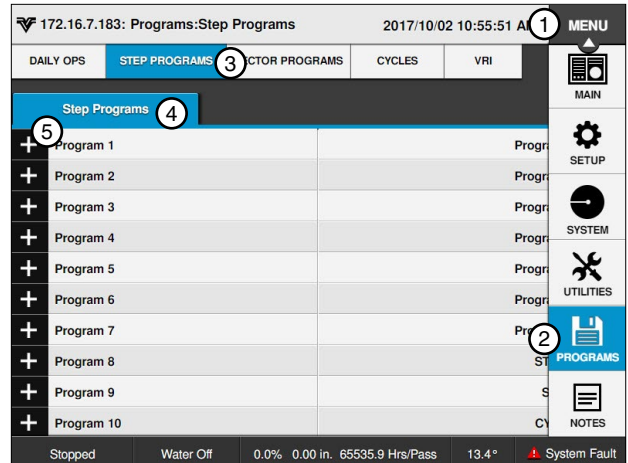

Figure 119-1 1. Menu
2. Programs
3. Step Programs
4. Step Programs
5. Add New Program
6. Wind Condition
7. Higher Than
8. MPH
9. Save

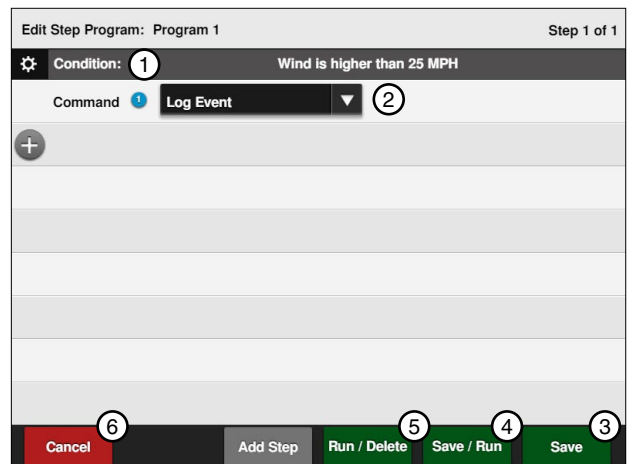

Figure 119-2 1. Wind Condition
2. Log Event Command
3. Save
4. Save / Run
5. Run / Delete
6. Cancel

Programs / Step Program Examples

Example 9. Using Run Program Command

In this example, the machine needs to complete two irrigation cycles and stop at 0°. To accomplish this, two programs are written Program #2 is written first. Refer to Figure 120-1.

Program #2 changes the depth to 0.50" At 180° and stop the machine at 0° to complete the second cycle.

Program #1 starts the machine at 3:00 am on 08/08/17, change the depth to 0.50" At 180°, change the depth to 1.00" At 0°, and load program two to complete the first cycle.

Program Two

Create program two with two steps. Step 1 changes the water application to 0.50" at 180°, and Step 2 stops the machine at 0°.

Expected Conditions - Program Two:

- Machine Running at 0°

Program Machine By:

- Position: At 180°, Depth 0.50"
- Position: At 0°, Stop

Program Step 1

1. Program the position condition for this step. Refer to Figure 120-2.
 - a) Select the **Choose Condition** drop-down menu and choose **Position**.
 - b) Select the **Degrees** field, enter **1, 8, 0, 0** for 180.0 degrees and push **Enter** to retain the value.
 - c) Push the **Enter** button to retain the values for the Position condition.
2. Enter the command to be executed at this position. Refer to Figure 120-3.
 - a) Select the **Choose Command** drop-down menu and choose **Depth**.
 - b) Select the **Inches** field and enter **0, 5, 0** for 0.50 inches and push **Enter** to retain the value.
3. Push **Add Step** to add step 2.

Program Step 2

4. Program the position condition for this step. Refer to Figure 120-3.
 - a) Select the **Choose Condition** drop-down menu, choose **Position**.
 - b) Use the default setting of **0.0** degrees in the **Degrees** field.
 - c) Push the **Enter** button to retain the values for the Position condition.
 - d) Select the **Choose Command** drop-down menu, choose **Start/Stop**, and push **Stop**.

Finish Programming

5. Finish the program by selecting one of the following.
 - Push **Save** to save the program.

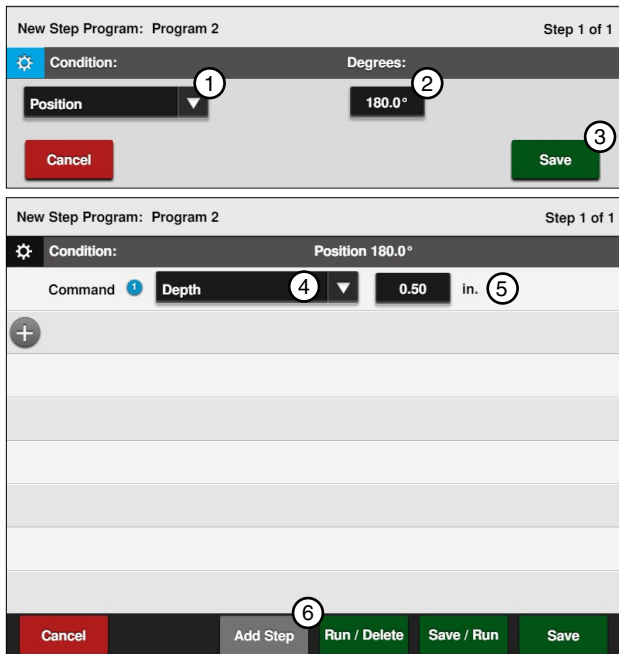

Figure 120-1 1. Position Condition 2. Degrees 3. Save 4. Depth Command 5. Inches 6. Add Step

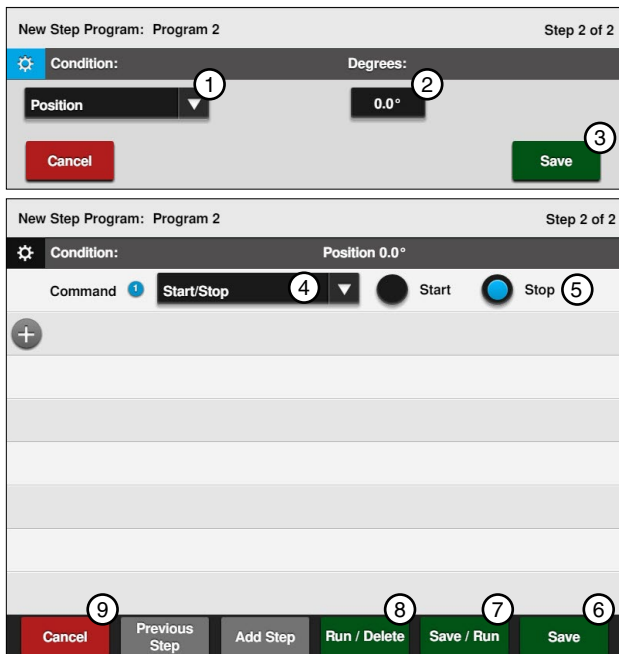

Figure 120-2 1. Position Condition 2. Degrees 3. Save 4. Start/Stop Command 5. Stop 6. Save 7. Save / Run 8. Run / Delete 9. Cancel

Example 9. Using Run Program Command (Continued)

Program One

Expected Conditions - First Program:

- Machine Off at 0°

Program Machine By:

- Time: On 08/08/17 at 3:00:00 AM, Forward, Water On, Depth 1.00", Start
- Position: At 180°, Depth 0.50"
- Position: At 0°, Depth 1.00", Run Program 2

Start Programming

To write program one of Example 9 follow these steps:

6. Push **Menu**, **Programs**, and **Step Programs** to view the Step Programs screen. Refer to Figure 121-1.
7. Push the **New Program** button corresponding to the preferred program number.

NOTE
 •Only Program one needs to be running in order to execute this example successfully.

Program Step 1

8. Program the date and time condition for this step follow these steps:
 - a) Select the **Choose Condition** drop-down menu and choose **Date/Time**. Refer to Figure 121-2.
 - b) Select the **Date (YYYY-MM-DD)** field and enter 08, 08, 17 for August 8, 2017 and push **Enter** to retain the value.
 - c) Select the **Time (HH:MM)** field and choose 03, 00, 00 for 3:00 and push **Enter** to retain the value.
 - d) Push the **AM** button the set the condition to **AM**.
 - e) Push the **Enter** button to retain the values for the Date/Time condition.

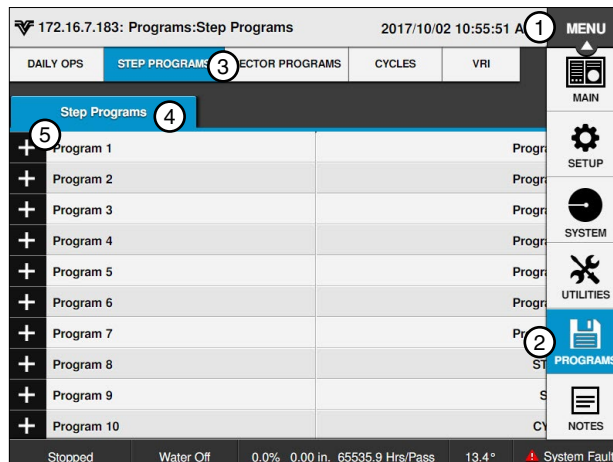

Figure 121-1 1. Menu 2. Programs 3. Step Programs 4. Step Programs 5. New Program

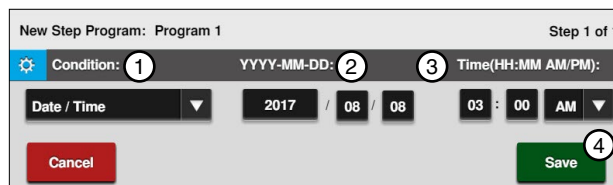

Figure 121-2 1. Date/Time Condition 2. Date 3. Time 4. Save

Programs / Step Program Examples

Example 9. Using Run Program Command (Continued)

Program Step 1 (Continued)

9. Enter the commands to be executed at that time. Refer to Figures 122-1.
 - a) Select the **Choose Command** drop-down menu and choose **Depth**.
 - b) Select the **Inches** field, enter **1, 0, 0** for 1.00 inches and push **Enter** to retain the value.
 - c) Select the **Add Command** drop-down menu and choose **Water**.
 - d) Push the **On** button to set the command to Water On.
 - e) Push the **Next** button.
 - f) Select the **Add Command** drop-down menu and choose **Direction**.
 - g) Push the **Forward** button to set the command to **Forward**.
 - h) Select the **Add Command** drop-down menu and choose **Start/Stop**.
 - i) Push the **Start** button to set the command to **Start**.

10. Push **Add Step** to add step 2.

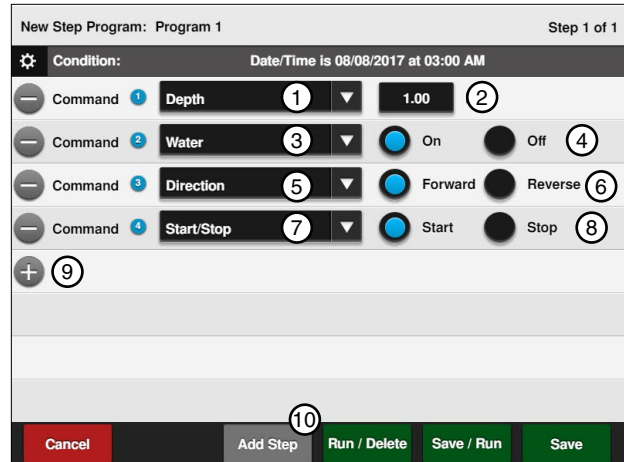

Figure 122-1 1. Depth Command 6. Forward
2. Inches 7. Start/Stop Command
3. Water Command 8. Start
4. On 9. Add Command
5. Direction Command 10. Add Step

Example 9. Using Run Program Command (Continued)

Program Step 2

11. Program the position condition for this step. Refer to Figure 123-1.
 - a) Select the **Choose Condition** drop-down menu and choose **Position**.
 - b) Select the **Degrees** field, enter **1, 8, 0, 0** for 180.0 degrees and push **Enter** to retain the value.
 - c) Push the **Save** button to retain the values for the Position condition.
12. Enter the command to be executed at this position.
 - a) Select the **Choose Command** drop-down menu and choose **Depth**.
 - b) Select the **Inches** field, enter **5, 0** for 0.50 inches and push **Enter** to retain the value.

13. Push **Add Step** to add step 3.

Program Step 3

14. Program the position condition for this step. Refer to Figure 123-2.
 - a) Select the **Choose Condition** drop-down menu and choose **Position**.
 - b) Use the default setting of **0.0** degrees in the **Degrees** field. Push **Enter** to retain the value.
 - c) Push the **Save** button to retain the values for the Position condition.
15. Enter the commands to be executed at this position.
 - a) Select the **Choose Command** drop-down menu and choose **Depth**.
 - b) Select the **Inches** field, enter **1, 0, 0** for 1.00 inches, and push **Enter** to retain the value.
 - c) Select the **Add Command** drop-down menu and choose **Run Program**.
 - d) The default selection is Program 1. Select the drop-down menu and choose **Program 2** for stored program 2.

Finish Programming

16. Finish the program by selecting one of the following. Refer to Figure 123-2.
 - Push **Save** to save the program.
 - Push **Save / Run** to save and then run the program.
 - Push **Run / Delete** to run the program once and then delete it.
 - Push **Cancel** to return to the main step program screen.

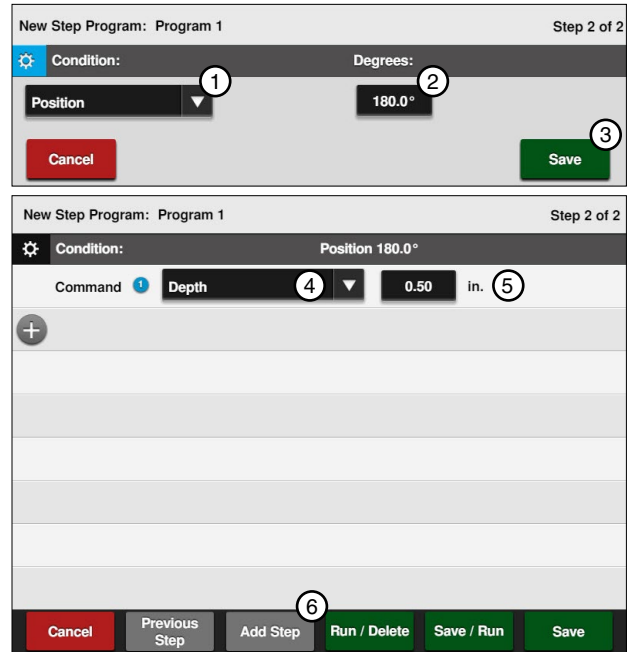

Figure 123-1 1. Position Condition 2. Degrees 3. Save 4. Depth Command 5. Inches 6. Add Step

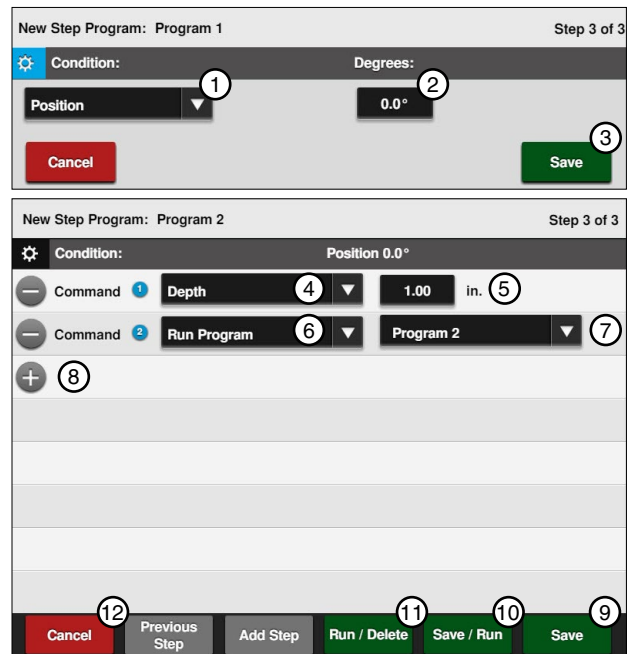

Figure 123-2 1. Position Condition 2. Degrees 3. Save 4. Depth Command 5. Inches 6. Run Program Command 7. Program 8. Add Command 9. Save 10. Save / Run 11. Run / Delete 12. Cancel

Programs / Step Program Examples

Example 9. Using Run Program Command (Continued)

Program Operation

The programming for Example 9 is complete.

The machine starts on August 08, 2017 at 3:00 AM, changes the water application to 0.50" at 180°, changes water application to 1.00" at 0°, and then loads program #2. Program 2 changes the water application to 0.50" at 180° and stops the machine at 0°.

This sequence of events could have been programmed all in one program by adding steps 4 and 5 to the first program. However, this example was used to illustrate how one program could load another, and how it can be applied.

There could be 17 stored programs, with each one performing a different sequence of events. These could be run one right after the other by using the Run Program command described in this example.

Scheduled Irrigation Cycles

Example 10. Time Delay with Run Program Command

This example illustrates one way to write a series of step programs, one program per irrigation cycle with time delays between each program. Execute the series of programs by running program one, program two, and program three automatically as they are called upon. Refer to Figure 125-1.

Current Conditions:

- Machine Off at 0°

Program Machine To:

- Start on 08/08/17, at 3:00 AM, Forward, Water On, Depth 1.00"
- Depth 0.75" at 180°
- Stop machine at 0° after 3 complete irrigation cycles with a 2 day (2880 minute) delay in between each cycle

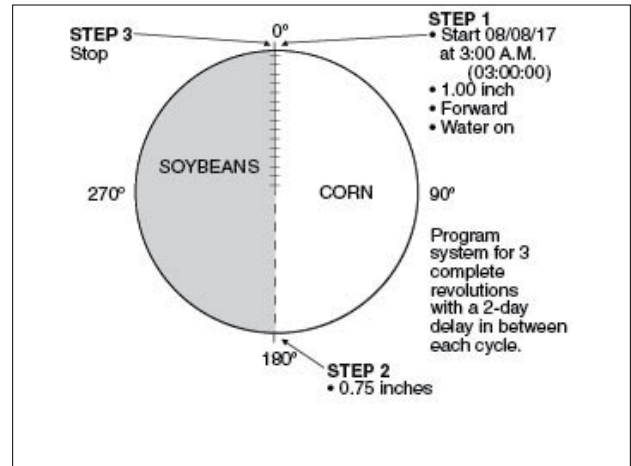

Figure 125-1

Programs / Step Program Examples

Example 10. Time Delay with Run Program Command (Continued)

Program Three

Step 1: At 180°, Depth 0.75"

Step 2: At 0°, Stop

Start Programming

To write the third program of Example 1 follow these steps:

Program Step 1

17. Program the position condition for this step. Refer to Figure 126-1.

- Select the **Choose Condition** drop-down menu and choose **Position**.
- Select the **Degrees** field, enter **1, 8, 0, 0** for 180.0 degrees and push **Enter** to retain the value.
- Push the **Save** button to retain the values for the Position condition.

18. Enter the command to be executed at this position.

- Select the **Choose Command** drop-down menu and choose **Depth**.
- Select the **Inches** field and enter **0, 7, 5** for 0.75 inches, push **Enter** to retain the value.

19. Push **Add Step** to add step 2.

Program Step 2

20. Program the position condition for this step. Refer to Figure 126-2.

- Select the **Choose Condition** drop-down menu and choose **Position**.
- Use the default setting of **0.0** degrees in the **Degrees** field.
- Push the **Save** button to retain the values for the Position condition.

21. Enter the command to be executed at this position. Refer to Figure 126-2.

- Select the **Choose Command** drop-down menu.
- Choose **Start/Stop** and use the default setting of **Stop**.

Finish Programming

22. Finish the program by selecting one of the following. Refer to Figure 126-2.

- Push **Save** to save the program.
- Push **Save / Run** to save and then run the program.
- Push **Run / Delete** to run the program once and then delete it.
- Push **Cancel** to return to the main step program screen.

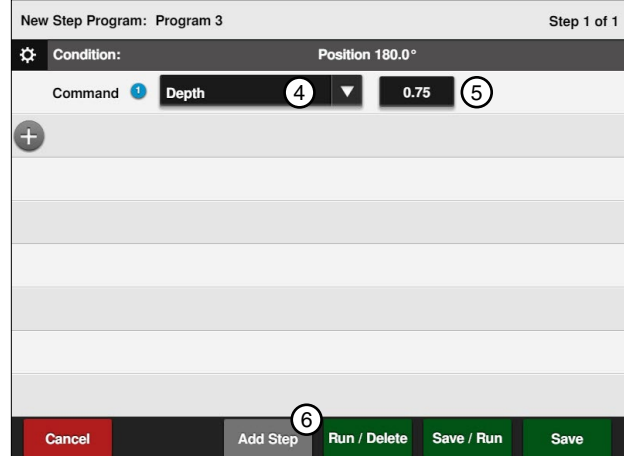
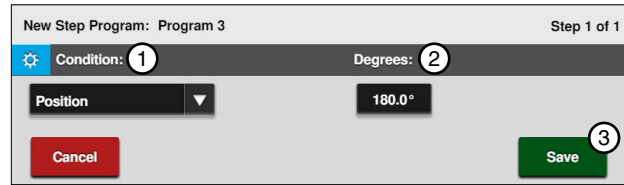

Figure 126-1 1. Position Condition 2. Degrees 3. Save 4. Depth Command 5. Inches 6. Add Step

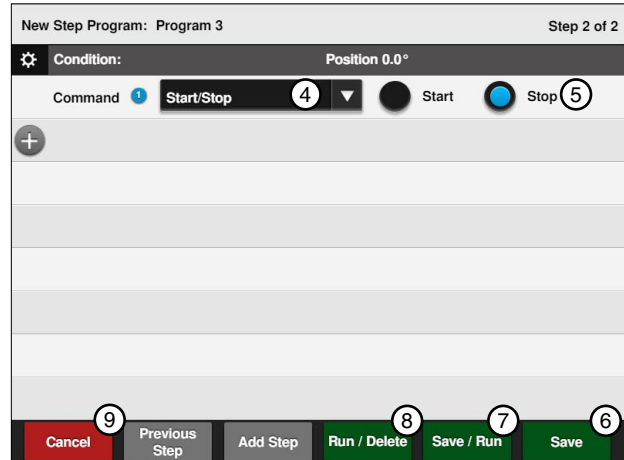
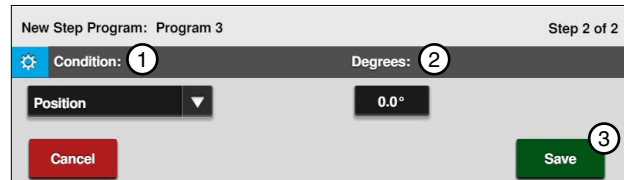

Figure 126-2 1. Position Condition 2. Degrees 3. Save 4. Start/Stop Command 5. Stop 6. Save 7. Save / Run 8. Run / Delete 9. Cancel

Example 10. Time Delay with Run Program Command (Continued)

Program Two

Step 1: At 180°, Depth 0.75"

Step 2: At 0°, Stop

Step 3: At 2880 Minutes Delay, Water On, Depth 1.00", Forward, Start, run Program 3

Start Programming

To write the second program of Example 1 follow these steps:

Program Step 1

23. Program the position condition for this step.
 - a) Select the **Choose Condition** drop-down menu and choose **Position**.
 - b) Select the **Degrees** field, enter **1, 8, 0, 0** for 180.0 degrees and push **Enter** to retain the value.
 - c) Push the **Save** button to retain the values for the Position condition.
24. Enter the command to be executed at this position. Refer to Figure 127-1.
 - a) Select the **Choose Command** drop-down menu and choose **Depth**.
 - b) Select the **Inches** field and enter **0, 7, 5** for 0.75 inches, and push **Enter** to retain the value.
25. Push **Add Step** to add step 2.

Program Step 2

26. Program the position condition for this step. Refer to Figure 127-2.
 - a) Select the **Choose Condition** drop-down menu and choose **Position**.
 - b) Use the setting of **0.0** degrees in the **Degrees** field.
 - c) Push the **Save** button to retain the values for the Position condition.
27. Enter the command to be executed at this position.
 - a) Select the **Choose Command** drop-down menu, choose **Start/Stop**.
 - b) Use the setting of **Stop**.
28. Push **Add Step** to add step 3.

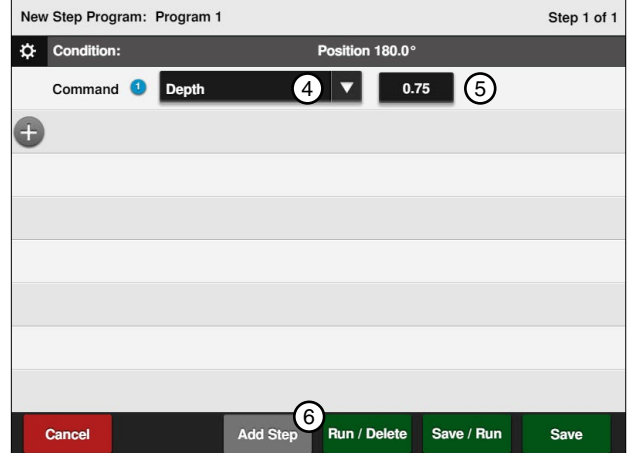
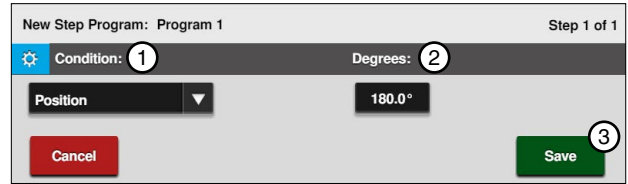

Figure 127-1 1. Position Condition 4. Depth Command
2. Degrees 5. Inches
3. Save 6. Add Step

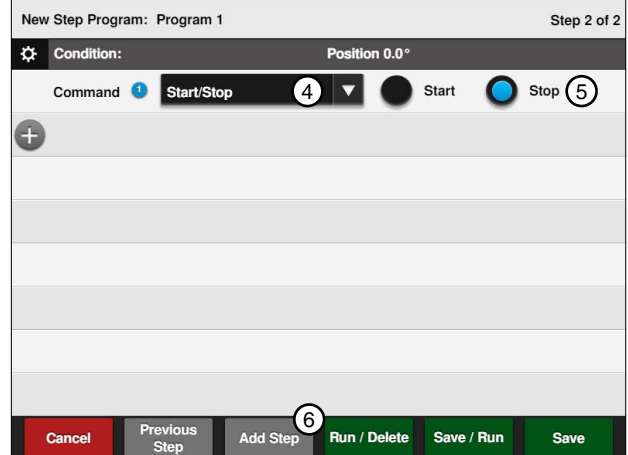
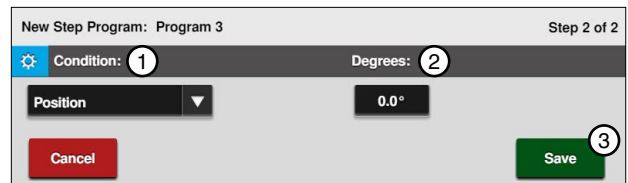

Figure 127-2 1. Position Condition 4. Start/Stop Command
2. Degrees 5. Stop
3. Save 6. Add Step

Programs / Step Program Examples

Example 10. Time Delay with Run Program Command (Continued)

Program Step 3

29. Program the delay time condition for this step. Refer to Figure 128-1.

- Select the **Choose Condition** drop-down menu and choose **Delay**.
- Select the **Delay Time** field and enter **2, 8, 8, 0** for 2880 minutes, push **Enter** to retain the value.
- Push the **Minutes** button to set the condition as **Minutes**.
- Push the **Save** button to retain the value for the Delay condition.

NOTE: A delay only counts as down time when the power is on.

30. Enter the commands to be executed after the delay. Refer to Figure 128-2.

- Select the **Choose Command** drop-down menu and choose **Water**.
- Push the **On** button to set the command to Water On.
- Select the **Add Command** drop-down menu and choose **Depth**.
- Push the **Inches** button, enter **1, 0, 0** for 1.00 inches and push **Enter** to retain the value.
- Select the **Add Command** drop-down menu and choose **Direction**.
- Push the **Forward** button to set the command to **Forward**.
- Select the **Add Command** drop-down menu and choose **Start/Stop**.
- Push the **Start** button to set the command to **Start**.
- Select the **Add Command** drop-down menu and choose **Run Program**.
- The default selection is Program 1. Select the drop-down menu and choose **Program 3** for stored program 3.

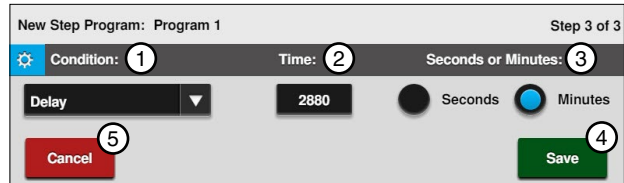

Figure 128-1 1. Delay Condition 2. Time 3. Seconds or Minutes 4. Save 5. Cancel

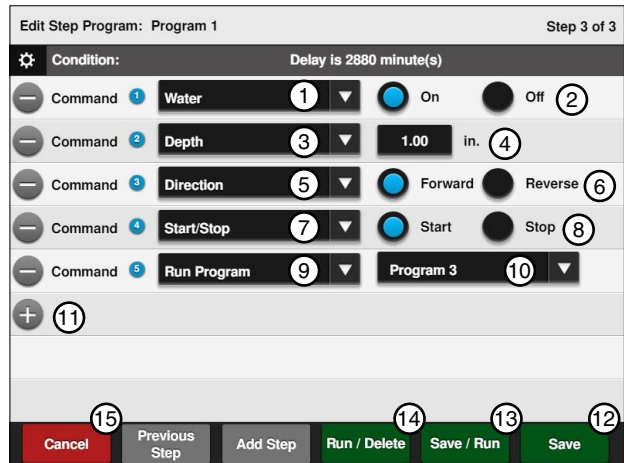

Figure 128-2 1. Water Command 2. Water On 3. Depth Command 4. Inches 5. Direction Command 6. Forward 7. Start/Stop Command 8. Start 9. Run Program Command 10. Program 11. Add Command 12. Save 13. Save / Run 14. Run / Delete 15. Cancel

Finish Programming

31. Finish the program by selecting one of the following. Refer to Figure 128-2.

- Push **Save** to save the program.
- Push **Save / Run** to save and then run the program.
- Push **Run / Delete** to run the program once and then delete it.
- Push **Cancel** to return to the main step program screen.

Example 10. Time Delay with Run Program Command (Continued)

Program One

- Step 1: At 3:00 AM on 08/08/17, Water On, Depth 1.00", Forward, Start
- Step 2: At 180°, Depth 0.75"
- Step 3: At 0°, Stop
- Step 4: At 2880 Minutes Delay, Water On, Depth 1.00", Forward, Start, Run Program #2

Program Step 1

Start Programming

To write the first program of Example 10 follow these steps:

1. Push **Menu**, **Programs**, and **Step Programs** to view the Step Programs screen. Refer to Figure 129-1.
2. Push the **New Program** button corresponding to the preferred program number.
3. Program the date and time condition for this step follow these steps:
 - a) Select the **Choose Condition** drop-down menu and choose **Date/Time**. Refer to Figure 129-2.
 - b) Select the **Date (YYYY/MM/DD)** field and choose 2017, 08, 08 for August 08, 2017, push **Enter** to retain the value.
 - c) Select the **Time (HH:MM)** field and choose 03, 00, push **Enter** to retain the value.
 - d) Push the **AM** button the set the condition to AM.
 - e) Push the **Save** button to retain the values for the Date/Time condition.
4. Enter the commands to be executed at that time. Refer to Figure 129-2.
 - a) Select the **Choose Command** drop-down menu and choose **Water**.
 - b) Push the **On** button to set the command to Water On.
 - c) Select the **Add Command** drop-down menu and choose **Depth**.
 - d) Push the **Inches** field, enter **1, 0, 0** for 1.00 inches and push **Enter** to retain the value.
 - e) Select the **Add Command** drop-down menu and choose **Direction**.
 - f) Push the **Forward** button to set the command to **Forward**.
 - g) Select the **Add Command** drop-down menu and choose **Start/Stop**.
 - h) Push the **Start** button to set the command to **Start**.
5. Push **Add Step** to add step 2.

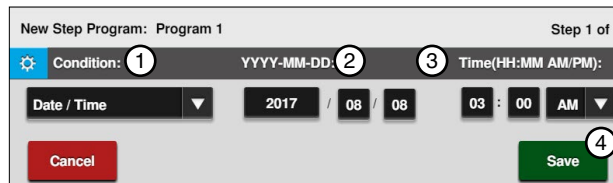

Figure 129-1 1. Date/Time Condition 3. Time
2. Date 4. Save

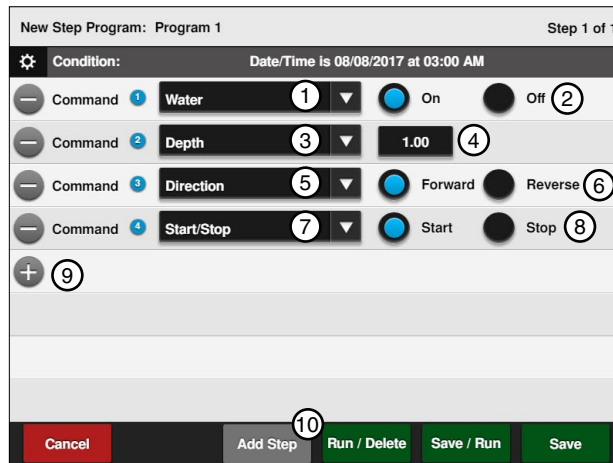

Figure 129-2 1. Water Command 6. Forward
2. Water On 7. Start/Stop Command
3. Depth Command 8. Start
4. Inches 9. Add Command
5. Direction Command 10. Add Step

Programs / Step Program Examples

Example 10. Time Delay with Run Program Command (Continued)

Program Step 2

6. Program the position condition for this step. Refer to Figure 130-1.
 - a) Select the **Choose Condition** drop-down menu and choose **Position**.
 - b) Select the **Degrees** field, enter **2, 7, 0, 0** for 270.0 degrees and push **Enter** to retain the value.
 - c) Push the **Save** button to retain the values for the Position condition.
7. Enter the command to be executed at this position. Refer to Figure 130-1.
 - a) Select the **Choose Command** drop-down menu and choose **Depth**.
 - b) Select the **Inches** field, enter **7, 5** for 0.75 inches and push **Enter** to retain the value.
8. Push **Add Step** to add step 3.

Program Step 3

9. Program the position condition for this step.
 - a) Select the **Choose Condition** drop-down menu and choose **Position**. Refer to Figure 130-2.
 - b) Use the setting of **0.0** degrees in the **Degrees** field.
 - c) Push the **Save** button to retain the values for the Position condition.
 - d) Select the **Choose Command** drop-down menu and choose **Start/Stop**. Refer to Figure 130-2.
 - e) Push the **Stop** button to set the command to **Start**.
10. Push **Add Step** to add step 4.

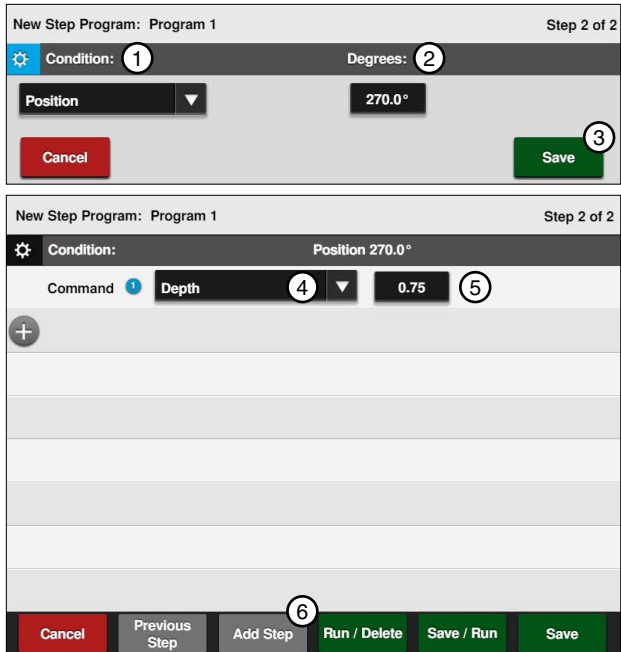

Figure 130-1 1. Position Condition 2. Degrees 3. Save 4. Depth Command 5. Inches 6. Add Step

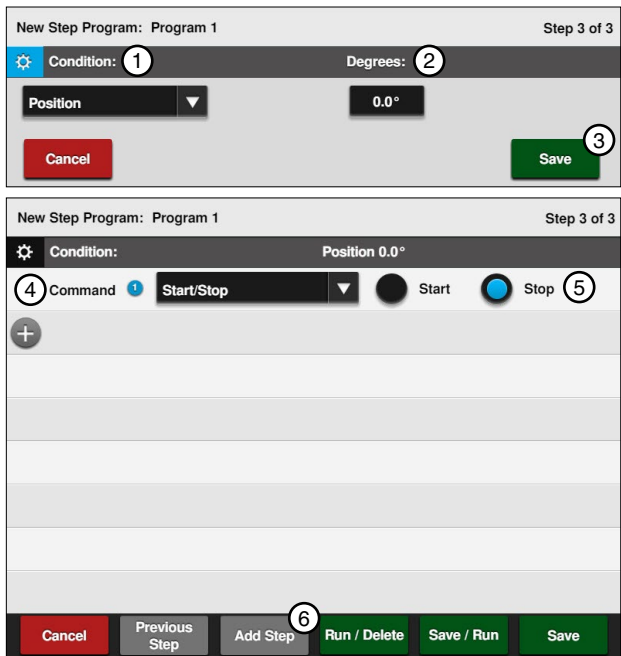

Figure 130-2 1. Position Condition 2. Degrees 3. Save 4. Start/Stop Command 5. Start 6. Add Step

Example 10. Time Delay with Run Program Command (Continued)

Program Step 4

11. Program the delay time condition for this step. Refer to Figure 131-1.

- Select the **Choose Condition** drop-down menu and choose **Delay**.
- Select the **Delay Time** field and enter **2, 8, 8, 0** for 2880 minutes and push **Enter** to retain the value.
- Push the **Minutes** button to set the condition to **Minutes**.
- Push the **Save** button to retain the values for the Delay condition.

NOTE: A delay time only counts down when the power is on.

12. Enter the commands to be executed after the delay. Refer to Figure 131-2.

- Select the **Choose Command** drop-down menu and choose **Water**.
- Push the **On** button to set the command to Water On.
- Select the **Add Command** drop-down menu and choose **Depth**.
- Select the **Inches** field, enter **1, 0, 0** for 1.00 inches and push **Enter** to retain the value.
- Select the **Add Command** drop-down menu and choose **Direction**.
- Push the **Forward** button to set the command to **Forward**.
- Select the **Add Command** drop-down menu and choose **Start/Stop**.
- Push the **Start** button to set the command to **Start**.
- Select the **Add Command** drop-down menu and choose **Run Program**. Refer to Figure 131-2.
- The default selection is Program 1. Select the drop-down menu and choose **Program 2** for stored program 2.

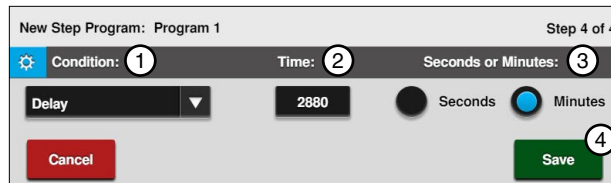

Figure 131-1 1. Delay Condition 2. Delay Time 3. Minutes or Seconds 4. Save

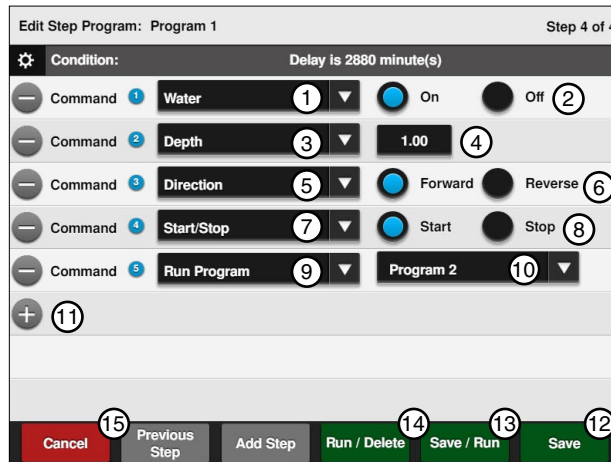

Figure 131-2 1. Water Command 2. Water On 3. Depth Command 4. Inches 5. Direction Command 6. Forward 7. Start/Stop Command 8. Start 9. Run Program Command 10. Program 11. Add Command 12. Save 13. Save / Run 14. Run / Delete 15. Cancel

Finish Programming

13. Finish the program by selecting one of the following. Refer to Figure 131-2.

- Push **Save** to save the program.
- Push **Save / Run** to save and then run the program.
- Push **Run / Delete** to run the program once and then delete it.
- Push **Cancel** to return to the main step program screen.

Programs / Step Program Examples

START\$ Program Example

The START\$ program is used by the Auto Restart power restart feature. There must be START\$ program and Auto Restart must be on for power restart to operate correctly. The START\$ program preexists on the step program screen by default to start the machine and pump (if wired to do so) after a 10 minute delay. The START\$ program can be edited if the user wants to change the delay mode, adjust delay time or do something in addition to the start command.

Delayed Start - Recommended

The default START\$ program is set for a delayed start, the machine is started 10 minutes (default delay time) after regaining power when Auto Restart is on. Use a delayed power restart to reduce the possibility of damage to an electric pump if power is lost and regained in a short period of time. The time delay for safe restart of your pump/machine may be different. When the machine starts, the Direction, Percent, Depth and Water On or Water Off settings remain the same as when the machine was last shut down. That is, unless the CYCLE\$ program or Daily Ops, along with a Step program, commands other conditions.

Immediate Start - Not Recommended

The START\$ program can be set for an immediate start, where after regaining power, the machine is started after the control panel's built in 10 second delay. **To set up an immediate start, change the START\$ program delay mode to seconds and set the delay time to 10, for a 10 second delay.**

NOTE: Always use the delay time recommended by the manufacturer of the pumping system.

When the machine starts, the Direction, Percent, Depth, and Water On or Water Off remain the same as when the machine was last shut down. That is, unless the CYCLE\$ program or Daily Ops, along with a step program, commands other conditions.

CAUTION

- A DELAYED START IS RECOMMENDED TO REDUCE THE POSSIBILITY OF DAMAGE TO AN ELECTRIC PUMP IF POWER IS LOST AND REGAINED IN A SHORT PERIOD OF TIME.

Programs / Step Program Examples

START\$ Program Example (Continued)

Editing

To edit the START\$ program follow these steps:

1. Push **Menu**, **Programs**, and **Step Programs** to view the Step Programs screen. Refer to Figure 133-1.
2. Push **START\$ Settings** then push **Edit**.

Edit Step 1

3. Push the **Settings** button (gear icon). Refer to Figure 133-1.
4. Edit the **Condition** and its parameters. The default Condition is a Delay of 10 Minutes.

NOTE

•A delay only counts down when the power is on.

5. Push the **Update** button to retain the changes.
6. START is the default first command.

NOTE

•The START\$ program **MUST** contain the Start command if you want the machine to start.

7. Edit or add Commands and their parameters.
8. When you are done editing, finish the program by pushing the **Save** button and selecting **Save** to save the program. Refer to Figure 133-2.

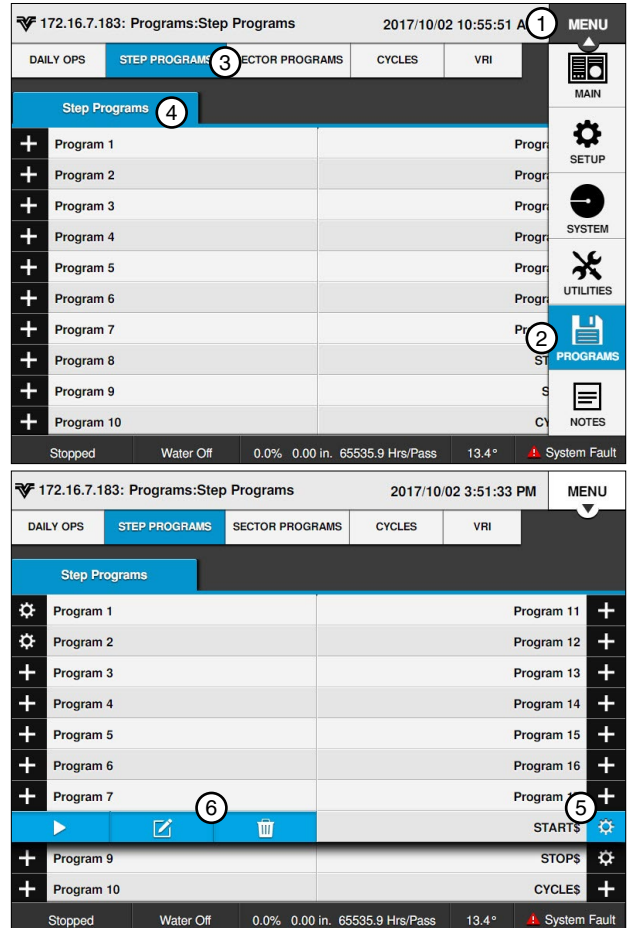

Figure 133-1 1. Menu 2. Programs 3. Step Programs 4. Step Programs 5. Settings 6. Edit

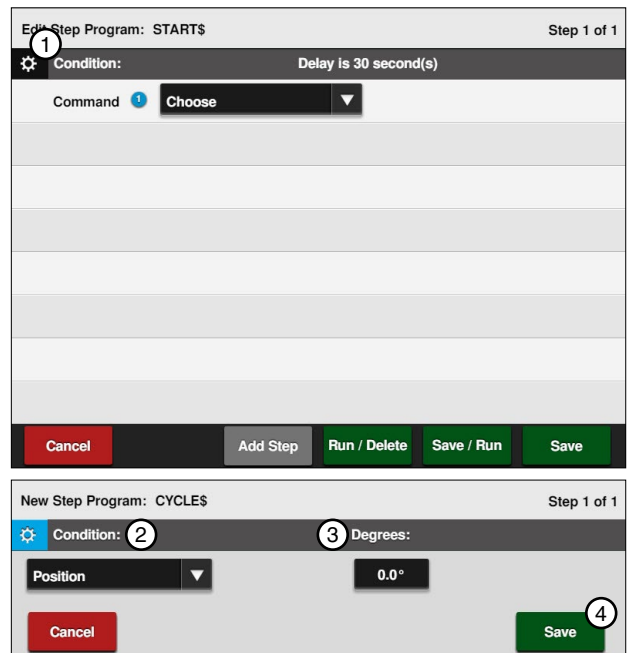

Figure 133-2 1. Settings 2. Condition 3. Degrees 4. Save

Programs / Step Program Examples

STOP\$ Program Example Immediate Stop

The STOP\$ program is used by Daily Ops and the CYCLE\$ program to stop the machine. The STOP\$ program preexists on the step program screen and is pre-programmed by default to stop the machine and pump (if wired to do so) after a 0 seconds delay. The STOP\$ program can be edited if the user wants the machine to do something in addition to the stop command. The Stop command is not required to be in the STOP\$ program.

⚠ WARNING

• TO REDUCE THE POSSIBILITY OF SEVERE INJURY, DEATH AND/OR MAJOR EQUIPMENT OR PROPERTY DAMAGE, NEVER USE THE START COMMAND IN THE STOP\$ PROGRAM.

Editing

To edit the STOP\$ program for Example 1 follow these steps:

1. Push **Menu**, **Programs**, and **Step Programs** to view the Step Programs screen. Refer to Figure 134-1.
2. Push **STOP\$** then push **Edit**.

Edit Step 1

3. Select the **Choose Command** drop-down menu and choose a different command. Refer to Figure 134-2.

NOTE: The Stop command is not required to be in the STOP\$ program.

or

4. Select the **Add Command** drop-down menu, choose a command and, if required, adjust its parameters.
5. When you are done editing, finish the program by pushing the **Save** button and selecting to **Save** the program.

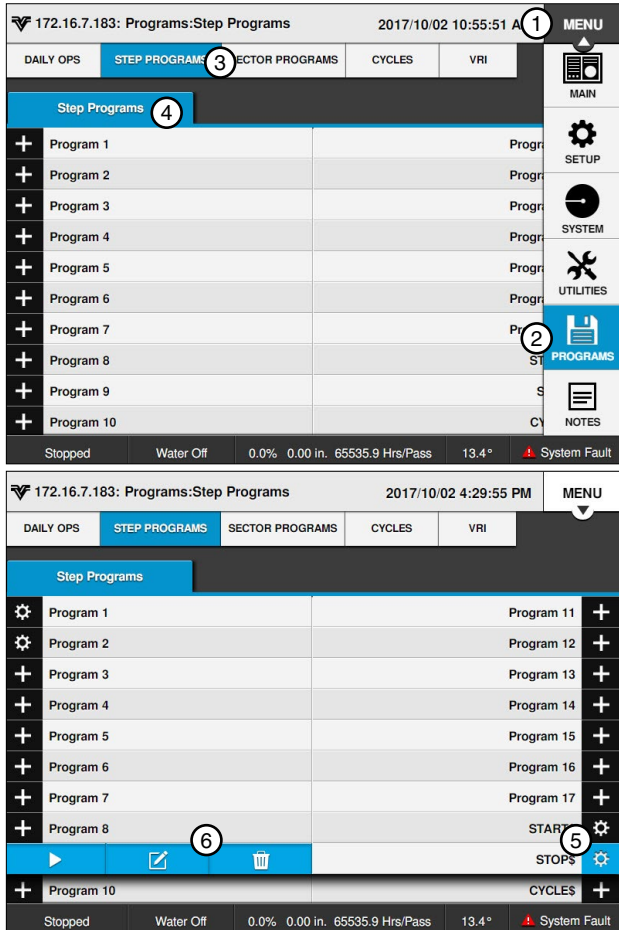

Figure 134-1 1. Menu
2. Programs
3. Step Programs
4. Step Programs
5. Settings
6. Edit

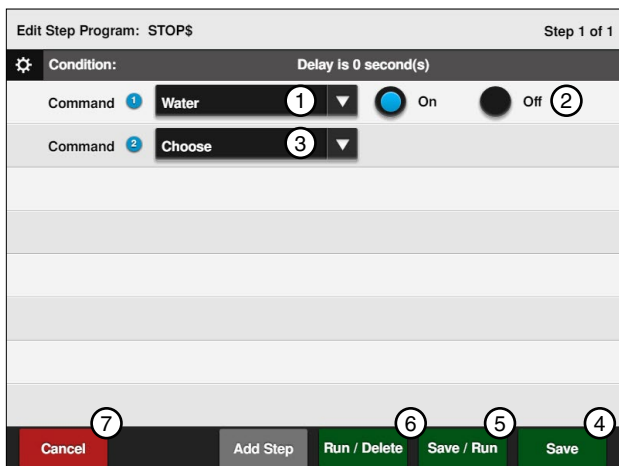

Figure 134-2 1. Water Command
2. Water On
3. Choose Command
4. Save
5. Save / Run
6. Run / Delete
7. Cancel

Programs / Step Program Examples

CYCLE\$ Program Example - Repeating Cycles

Using CYCLE\$ Program

In this example, the START\$, STOP\$, and CYCLE\$ programs are used to start the machine, complete two identical irrigation cycles, and stop the machine at 0°. Refer to Figure 135-1.

Expected Conditions:

- Delayed START\$ program is written
- STOP\$ program is written
- Machine Off at 0°
- SIS position set for 0°
- SIS is off

Program Machine By:

- CYCLE\$ program
- Position: At 0°, Forward, Depth 1.00"
- Position: At 180°, Depth 0.50"

NOTE

- The Stop-In-Slot is used as a counter by the computer to signal when a cycle has been completed. During each cycle, the machine **MUST** pass the Stop-In-Slot position in order to execute the Cycles program again.

Start Programming

To write the CYCLE\$ program for Example 1 follow these steps:

1. Push **Menu**, **Programs**, and **Step Programs** to view the Step Programs screen. Refer to Figure 135-2.
2. Push **CYCLE\$ Settings** then push **Edit**.

Program Step 1

3. Program the position condition for this step. Refer to Figure 135-3.
 - a) Select the **Choose Condition** drop-down menu and choose **Position**.
 - b) Select the **Degrees** field, enter **0, 0** for 0.0 degrees and push **Enter** to retain the value.
 - c) Push the **Save** button to retain the values for the Position condition.

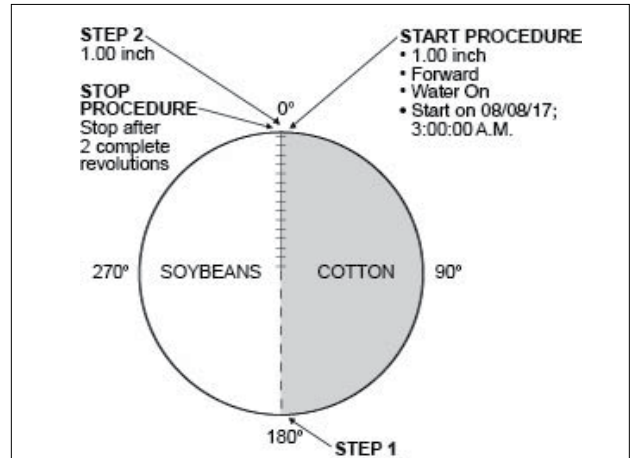

Figure 135-1

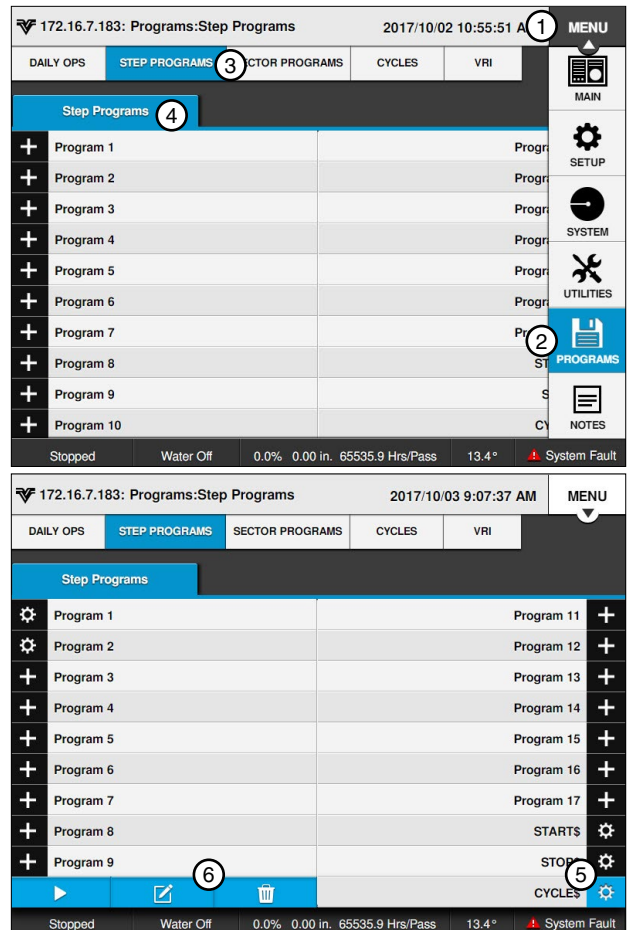

Figure 135-2 1. Menu 2. Programs 3. Step Programs 4. Step Programs 5. Settings 6. Edit

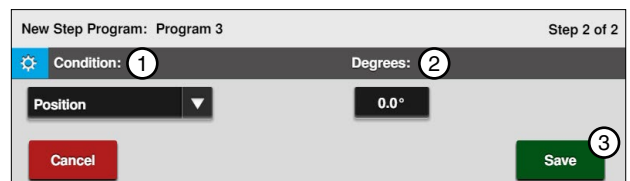

Figure 135-3 1. Position Condition 2. Degrees 3. Save

Programs / Step Program Examples

Example 1. Using Cycles Program (Continued)

Program Step 1 (Continued)

4. Enter the commands to be executed. Refer to Figure 136-1.
 - a) Select the **Choose Command** drop-down menu and choose **Direction**.
 - b) Push the **Forward** button to set the command to **Forward**.
 - c) Select the **Add Command** drop-down menu and choose **Depth**.
 - d) Select the **Inches** field, enter **1, 0, 0** for 1.00 inches and push **Enter** to retain the value.
5. Push **Add Step** to add step 2.

Program Step 2

6. Program the position condition for this step. Refer to Figure 136-2.
 - a) Select the **Choose Condition** drop-down menu and choose **Position**.
 - b) Select the **Degrees** field, enter **1, 8, 0, 0** for 180.0 degrees and push **Enter** to retain the value.
 - c) Push the **Save** button to retain the values for the Position condition.
7. Enter the command to be executed at this position. Refer to Figure 136-2.
 - a) Select the **Choose Command** drop-down menu and choose **Depth**.
 - b) Select the **Inches** field, enter **5, 0** for 0.50 inches and push **Enter** to retain the value.

Finish Programming

8. Finish the program by selecting one of the following. Refer to Figure 136-2.
 - Push **Save** to save the program.
 - Push **Save / Run** to save and then run the program.
 - Push **Run / Delete** to run the program once and then delete it.
 - Push **Cancel** to return to the main step program screen.

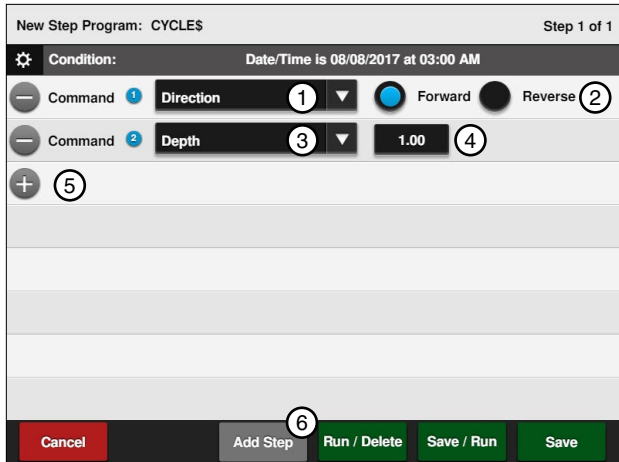

Figure 136-1 1. Direction Command 2. Forward 3. Depth Command 4. Inches 5. Add Command 6. Add Step

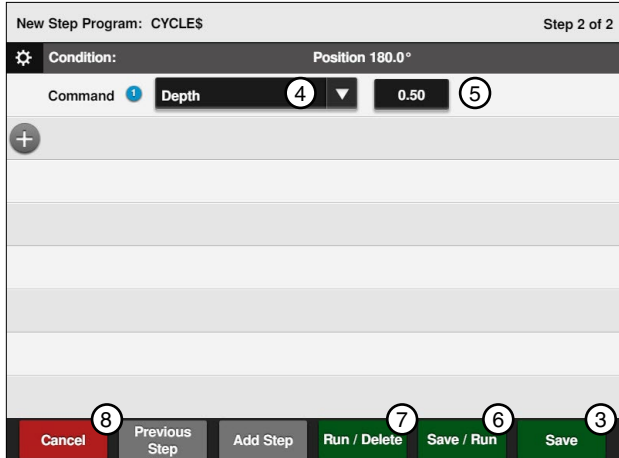
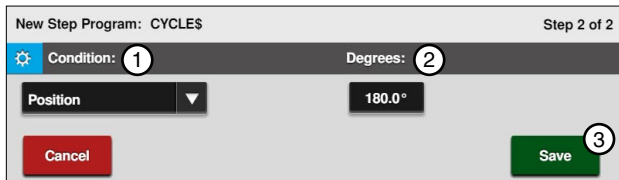

Figure 136-2 1. Position Condition 2. Degrees 3. Save 4. Depth Command 5. Inches 6. Save / Run 7. Run / Delete 8. Cancel

Example 1. Using Cycles Program (Continued)

Execute Cycles By Time

To execute the Cycles program due to a condition follow these steps:

1. Push **Menu**, **Programs**, and **Step Programs** to view the Step Programs screen. Refer to Figure 137-1.
2. Push the **New Program** button corresponding to the preferred program number.
3. Program the date and time condition for this step follow these steps:
 - a) Select the **Choose Condition** drop-down menu and choose **Date/Time**. Refer to Figure 137-2.
 - b) Select the **Date (YYYY-MM-DD)** field and choose 2017, 08, 08 for August 08, 2017, push **Enter** to retain the value.
 - c) Select the **Time (HH:MM)** field and choose 03, 00, 00 for 3:00, push **Enter** to retain the value.
 - d) Push the **AM** button to set the condition to **AM**.
 - e) Push the **Save** button to retain the values for the Date/Time condition.
4. Enter the command to be executed at that time.
 - a) Select the **Choose Command** drop-down menu and choose **Set Cycles**.
 - b) Select the **Set Cycles** field, enter the number of cycles to run, and push **Enter** to retain the value.

Finish Programming

5. Finish the program by selecting one of the following. Refer to Figure 137-2.
 - Push **Save** to save the program.
 - Push **Save / Run** to save and then run the program.
 - Push **Run / Delete** to run the program once and then delete it.
 - Push **Cancel** to return to the main step program screen.

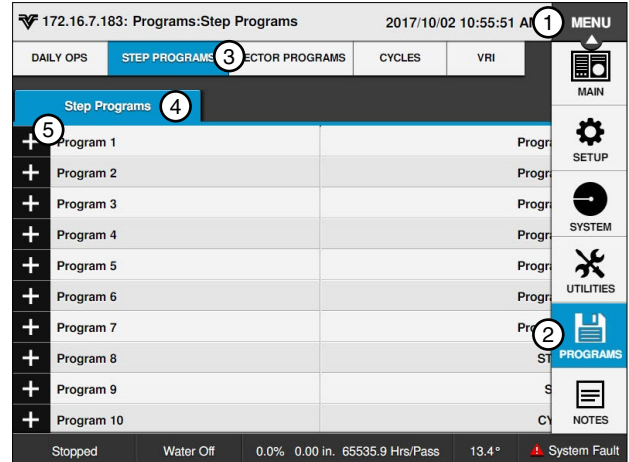

Figure 137-1 1. New Program

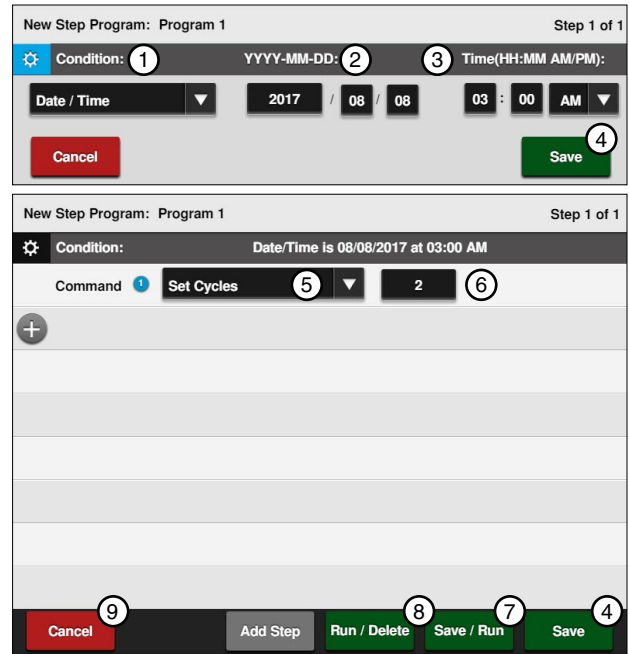

Figure 137-2 1. Date/Time Condition 2. Date 3. Time 4. Save 5. Set Cycles Command 6. Cycles 7. Save / Run 8. Run / Delete 9. Cancel

Programs / Step Program Examples

Sector Programs

From the Sector Program screen the user can choose to create, edit, save, run, review, and delete Sector Programs. Refer to Figure 139-1.

Sector programming allows you to specify commands to be executed in unique regions, or sectors, of the field. When the machine enters the region, the Sector Program overrides the normal machine operation with temporary settings. When the machine leaves the region, all settings are returned to the original settings.





Up to 20 Sector Programs can be written for one field, with a maximum of 9 commands in each. The commands in a program are executed in the order in which they appear in the program.

When the program is completed, it is deleted from the current memory, but remains in the stored memory.

Sector Program Functions

- Sector Program screen - Use to write new sector programs, review and edit stored sector programs which can be recalled for execution.
- Save - Use to save, save and run, or run and delete a sector program in stored memory.
- Run - Use to load stored sector programs in current memory for execution.
- Delete - Use to erase stored sector programs from memory.
- Edit - Use to review or make changes to a stored sector program.
- Stop - Use to stop a halt a sector program that is running.

Program Run Status Key

Display:	Color:	Status:
	Solid Green	Running
	Flashing Green	Active Running
	Solid Orange	Run and Delete
	Blinking Orange	Active and Running and Delete

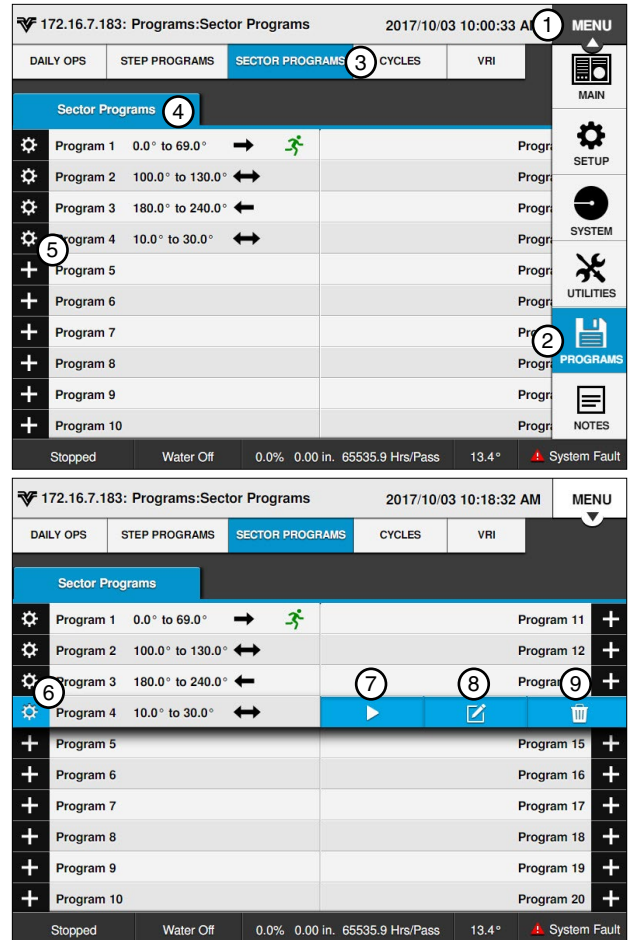

Figure 139-1 1. Menu 2. Programs 3. Sector Programs 4. Sector Programs 5. Add Program 6. Settings 7. Run/Stop 8. Edit 9. Delete

Programs / Sector Programs

Available Commands

- Stop
- Water
- Depth
- Percentage
- Cruise Control On
- Cruise Control Off
- Auxiliary 1 On/Off
- Auxiliary 2 On/Off
- End gun 1 through 4 Enable/Disable
- % of %
- % of Depth, Adjust Depth by a %
- VRI On/Off

Using Run

A stored Sector program can easily be run from the ICON10 control panel.

1. Push **Menu**, **Programs**, and **Sector Programs** to view the Sector Programs screen. Refer to Figure 140-1.
2. Select the number of the program you want to run by pushing the **Settings** button corresponding to the program number.
3. Push the **Run** button to run the selected program. Refer to Figure 140-1.

The program commands will be executed when the machine reaches the region specified. Indication that the program is running occurs in multiple places.

On the Sector Programs screen:

- A running icon appears next to the program being run.

On the Main screen:

- Programs appears in the status area. Refer to Figure 140-2.

Two Sector programs with overlapping regions, running in the same direction, cannot be run at the same time. If you attempt to run a stored program that overlaps with a running program, and runs in the same direction, the system displays a message telling you it cannot be loaded. Refer to Figure 140-3. You can then modify the start or end angles of one or the other programs to allow them both to be run.

NOTE

- Two Sector programs with overlapping regions, running in opposite directions, can be run at the same time.

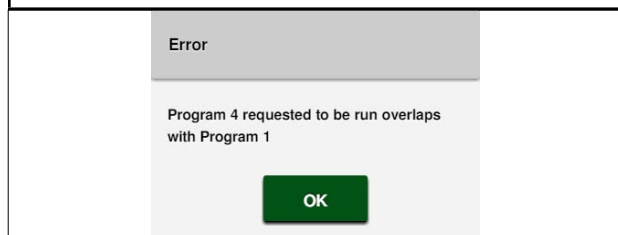

Figure 140-3 Error Message

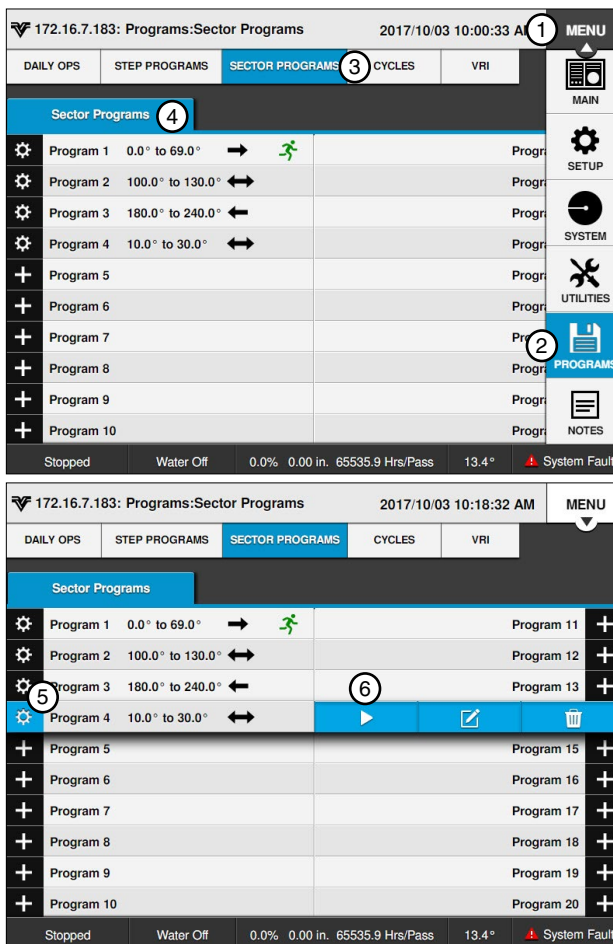

Figure 140-1 1. Menu
2. Programs
3. Step Programs



Figure 140-2 Main Screen With Programs Running

Sample Sector Program Design Form

The Sector Program Design Form is a useful tool when you are planning your Sector program. It provides you with the ability to describe the left and right angles, direction, and actions you want included in the program. Figure 141-1 below is an example of how the sectors could each be mapped out and described.

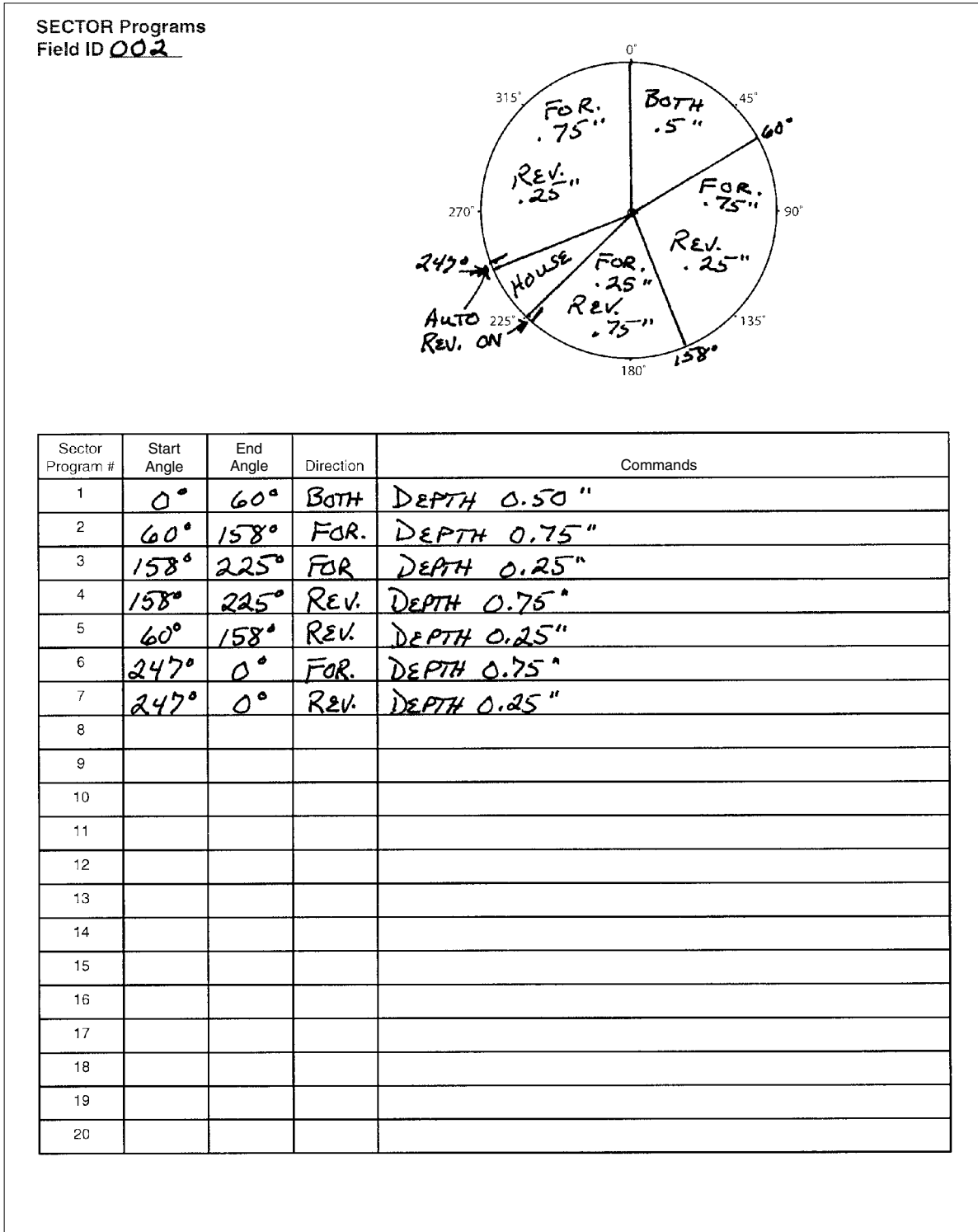

Figure 141-1

Programs / Sector Programs

Write a New Program

To write a new Sector program, fill in a copy of the Sector Program Design Form with commands for each step. Refer to the sample Sector Program Design Form on the previous page. Blank forms are located in the Appendix. Using a completed design form follow the steps:

1. Push **Menu**, **Programs**, and **Sector Programs** to view the Sector Programs screen. Refer to Figure 142-1.
2. Push the **Add Program** button corresponding to the program number.
3. Select the **Start Angle** field.
4. Using the numeric keypad, enter the start angle of the new sector.
5. Push **Enter** to retain this value.
6. Select the **End Angle** field. Refer to Figure 142-2.
7. Using the numeric keypad, enter the end angle of the new sector.
8. Push **Enter** to retain this value.
9. Select the **Direction** drop-down menu.
10. Choose the direction in which the machine will be moving when this sector program begins. The choices are:
 - Both - The program will begin when the machine is moving either forward or in reverse.
 - Forward - The program will begin only when the machine is moving forward.
 - Reverse - The program will begin only when the machine is moving in reverse.
11. Push **Save** to begin choosing commands.
12. To choose the commands for this sector follow these steps: Refer to Figure 142-3.
 - a) Select the **Choose Command** drop-down menu and choose a command.
 - b) Set the command as required to turn on/off, enable/disable or enter a parameter.
13. Repeat steps 2 through 12 for all sectors of the field.
14. Finish the program by selecting one of the following. Refer to Figure 142-2.
 - Push **Save** to save the program.
 - Push **Save / Run** to save and then run the program.
 - Push **Run / Delete** to run the program once and then delete it.
 - Push **Cancel** to return to the main step program screen.

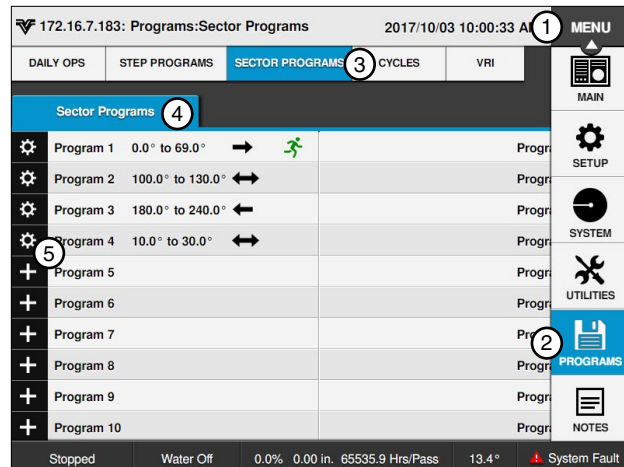

Figure 142-1 1. Menu 2. Programs 3. Sector Programs 4. Sector Programs 5. Add Program

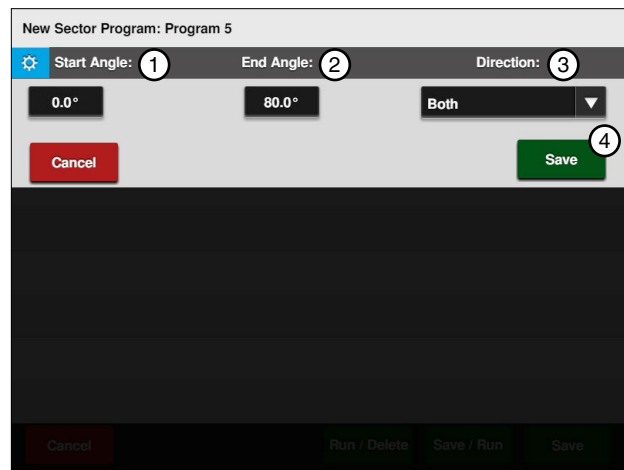

Figure 142-2 1. Start Angle 2. End Angle 3. Direction 4. Save

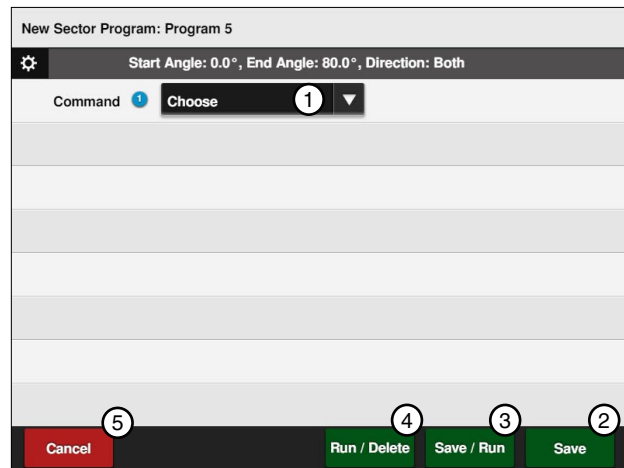

Figure 142-3 1. Choose Command 2. Save 3. Save / Run 4. Run / Delete 5. Cancel

Reviewing or Editing Sector Programs

To review current Sector program(s) that are running, or will be executed as soon as their boundaries are reached follow these steps:

1. Push **Menu**, **Programs**, and **Sector Programs** to view the Sector Programs screen. Refer to Figure 143-1.
2. Push the **Settings** button corresponding to the program number.
3. To review or edit the program.
 - If no changes are required, push Settings to accept the program and exit.
 - If changes are required, make changes to any command or condition by pushing the **Edit** button.
4. Finish the program by selecting one of the following. Refer to Figure 143-2.
 - Push **Save** to save the program.
 - Push **Save & Run** to save and then run the program.
 - Push **Run & Delete** to run the program once and then delete it.
 - Push **Cancel** to return to the main step program screen.

Deleting a Stored Program

To delete a Sector program that is stored in memory follow these steps:

1. Push **Menu**, **Programs**, and **Sector Programs** to view the Sector Programs screen. Refer to Figure 143-1.
2. Push the **Settings** button corresponding to the program number.
3. Push the **Delete** button to delete the stored program number.

Stopping a Running Program

To stop a program that is running follow these steps:

1. Push **Menu**, **Programs**, and **Sector Programs** to view the Sector Programs screen. Refer to Figure 143-1.
2. Push the **Settings** button corresponding to the program number.
3. Push the **Start/Stop** button to stop or start the program.

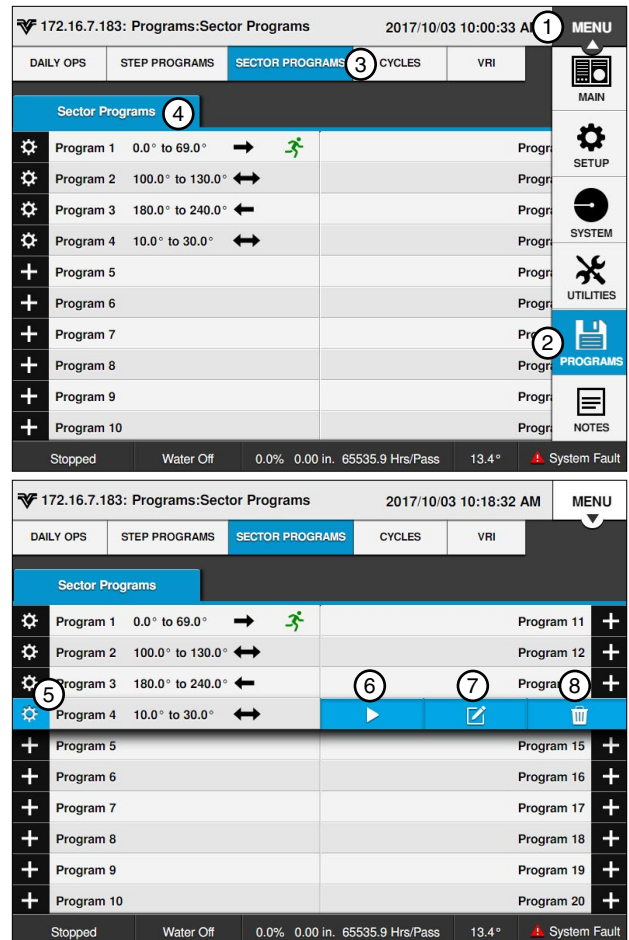

Figure 143-1 1. Menu 5. Settings
 2. Programs 6. Start/Stop
 3. Sector Programs 7. Edit
 4. Sector Programs 8. Delete

Programs / Sector Programs

Programs / Sector Program Examples

Designing Sector Programs

A sector program is a list of commands which need to occur in a specified order. The completed Sector Program Design Form example below illustrates how to use the form to outline the following example program. Refer to Figure 145-1.

Example Sector Program and Design Form

Current Conditions:

- Machine On at 0°

Program Machine By:

- Position: At 45°, Water On, End-Gun Disabled, Depth 0.75 Inches
- Position: At 135°, Return to original settings
- Position: At 180°, Water Off, Percent 100
- Position: At 225°, Return to original settings

The program design form has been filled out to reflect the example program. Follow these steps as a guide when thinking about programs you want to write.

1. Make a sketch of the field and identify what you want the irrigation machine to do.
2. Determine what must happen first. This will be Sector Program #1.
3. Identify the left and right angles of the sector (Ex: 45° and 135°).
4. Identify the direction in which the machine will be moving when the program is run (Forward, Reverse, or Both) (Ex: Both).
5. Identify what commands need to occur for Sector Program #1 (Ex: Water On, 1.00 inch Depth).
6. Determine conditions and commands for all other steps.

NOTE: All steps are executed in sequential order.

If you complete the Sector Program Design Form, it makes entering the program easy.

Just follow each row across and enter the correct information.

A blank Sector Program Design Forms are provided in the Appendix.

SECTOR Programs
Field ID 002

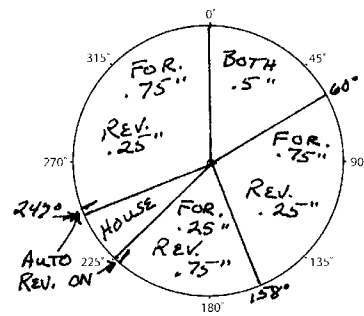

Sector Program #	Left Angle	Right Angle	Direction	Actions
1	0°	60°	BOTH	DEPTH 0.50"
2	60°	158°	FOR.	DEPTH 0.75"
3	158°	225°	FOR	DEPTH 0.25"
4	158°	225°	REV.	DEPTH 0.75"
5	60°	158°	REV.	DEPTH 0.25"
6	247°	0°	FOR.	DEPTH 0.75"
7	247°	0°	REV.	DEPTH 0.25"
8				
9				
10				
11				
12				
13				
14				
15				
16				
17				
18				
19				
20				

Figure 145-1

Programs / Sector Program Examples

Using the Depth and Percent Commands

In this programming example, the machine is programmed to override the normal system operation at a wet area of the field, resume normal operation, override the normal system operation at a dry area of the field, and resume normal operation. Refer to Figure 146-1.

Normal System Operation:

- Machine: On at 0°
- Water: On
- Direction: Forward
- Depth: 0.75 Inches

Program First Sector:

- Start Angle: 72°
- End Angle: 90°
- Direction: Both
- Command(s): Water Off, Percent 100

Program Second Sector:

- Start Angle: 180°
- End Angle: 225°
- Direction: Both
- Command(s): Depth 1.00 Inch

Programming a Sector

To program the sector for Depth follow these steps:

1. Push **Menu**, **Programs**, and **Sector Programs** to view the Sector Programs screen. Refer to Figure 146-2.
2. Push the **Add Program** button to the corresponding to Program.
3. Select the **Start Angle** field. Refer to Figure 146-3.
4. Using the numeric keypad, enter **7, 2, 0** for 72.0° as the start angle of the new sector.
5. Push **Enter** to retain the value.
6. Select the **End Angle** field.
7. Using the numeric keypad, enter **9, 0, 0** for 90.0° as the end angle of the new sector.
8. Push **Enter** to retain the value.
9. Select the **Direction** drop-down menu and choose **Both**.
10. Push the **Save** button to begin choosing commands.

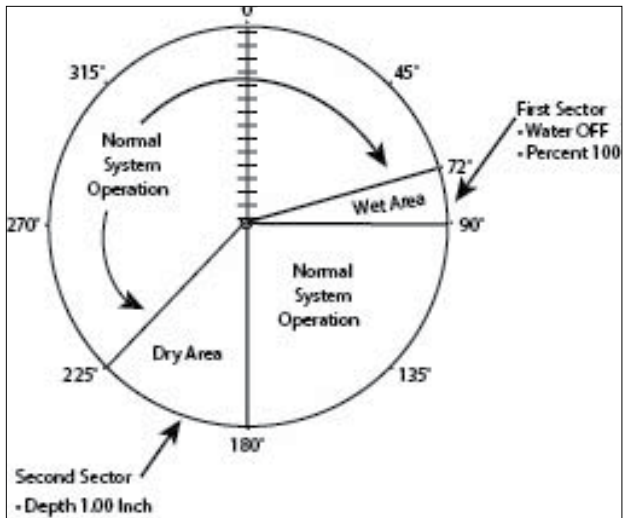

Figure 146-1

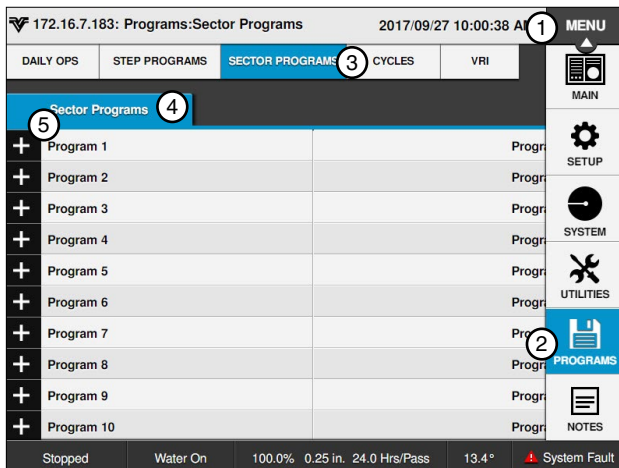

Figure 146-2 1. Menu 2. Programs 3. Sector Programs 4. Sector Programs 5. Add Program

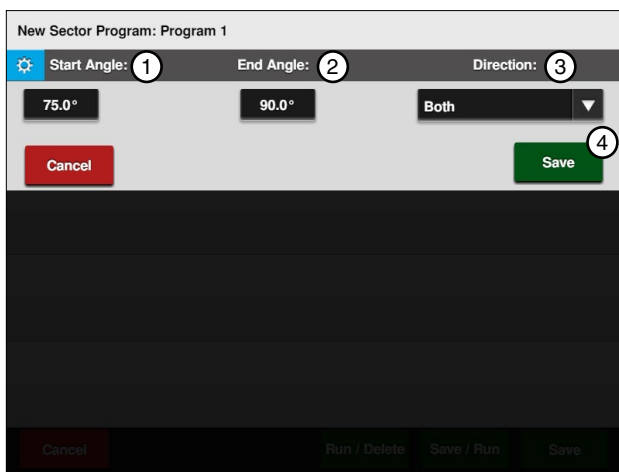

Figure 146-3 1. Start Angle 2. End Angle 3. Direction 4. Save

Programming the Sector (Continued)

11. To choose the Depth command for this sector follow these steps:

- Select the **Choose Command** drop-down menu and choose **Water**. Refer to Figure 147-1.
- Push the **Off** button to set the command to Water Off.
- Select the **Add Command** drop-down menu and choose **Percent**.
- Select the **Percent** field, enter **1, 0, 0, 0** for 100 percent.
- Push **Enter** to retain the value.

12. Finish the program by selecting one of the following. Refer to Figure 147-2.

- Push **Save** to save the program.
- Push **Save / Run** to save and then run the program.
- Push **Run / Delete** to run the program once and then delete it.
- Push **Cancel** to return to the main step program screen.

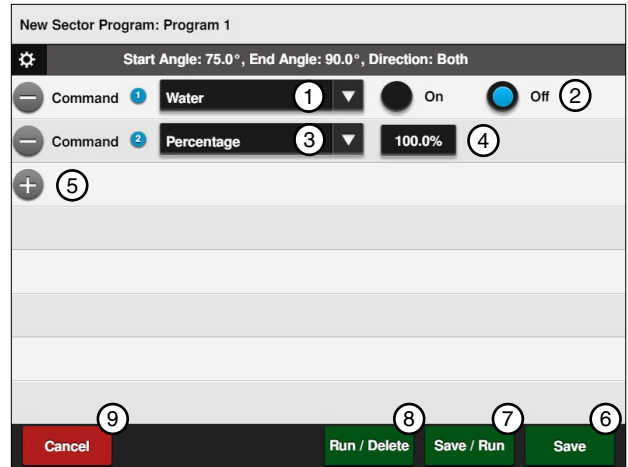

Figure 147-1

1. Water Command	6. Save
2. Water Off	7. Save / Run
3. Percent Command	8. Run / Delete
4. Percent	9. Cancel
5. Add Command	

Programs / Sector Program Examples

Programming the Next Sector

To program the second sector for Percentage follow these steps:

1. Push **Menu**, **Programs**, and **Sector Programs** to view the Sector Programs screen. Refer to Figure 148-1.
2. Push the **New Program** button corresponding to Program 2.
3. Select the **Start Angle** field. Refer to Figure 148-2.
4. Using the numeric keypad, enter **1, 8, 0, 0** for 180.0° as the start angle of the new sector.
5. Push **Enter** to retain the value.
6. Select the **End Angle** field.
7. Using the numeric keypad, enter **2, 2, 2, 0** for 222.0° as the end angle of the new sector.
8. Push **Enter** to retain the value.
9. Select the **Direction** drop-down menu and choose **Both**.
10. Push the **Save** button to begin choosing commands.
11. To choose the Percentage command for the second sector follow these steps:
 - a) Select the **Choose Command** drop-down menu and choose **Depth**. Refer to Figure 148-3.
 - b) Select the **Inches** field, enter **1, 0, 0** for 1.00 inches.
 - c) Push **Enter** to retain the value.
12. Finish the program by selecting one of the following. Refer to Figure 148-3.
 - Push **Save** to save the program.
 - Push **Save / Run** to save and then run the program.
 - Push **Run / Delete** to run and then delete the program.
 - Push **Cancel** to return to the main step program screen.

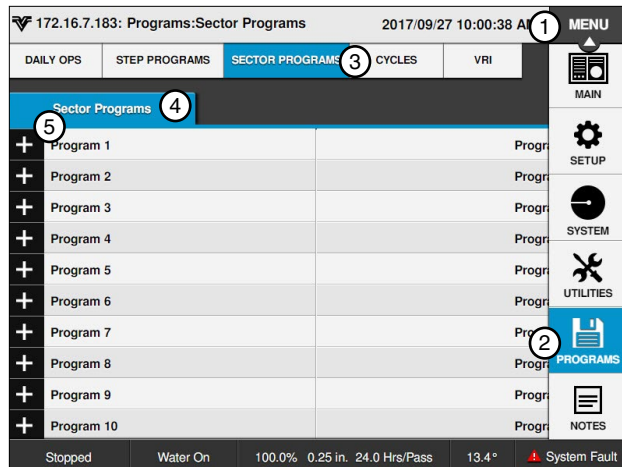

Figure 148-1 1. Menu 2. Programs 3. Sector Programs 4. Sector Programs 5. Add Program

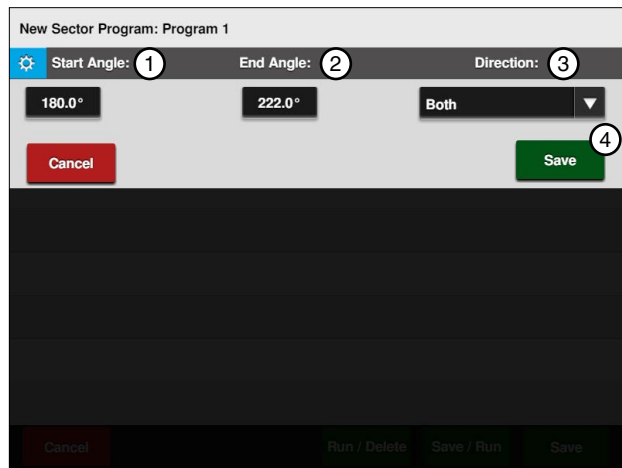

Figure 148-2 1. Start Angle 2. End Angle 3. Direction 4. Save

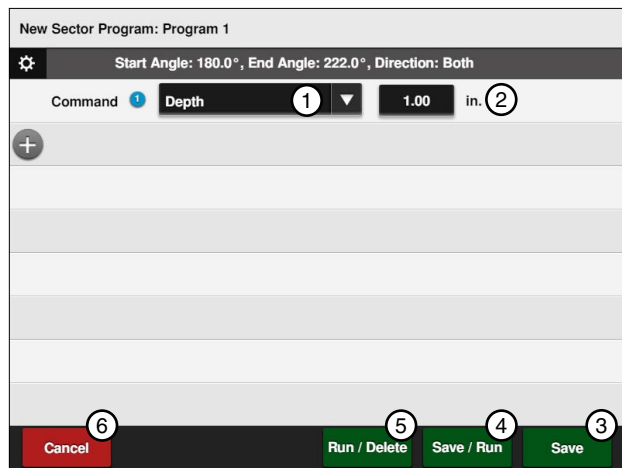

Figure 148-3 1. Depth Command 2. Inches 3. Save 4. Save / Run 5. Run / Delete 6. Cancel

Programs / Sector Program Examples

Using the Percent-of-Percent or Percent-of-Depth Command

In this program example, the region has recently experienced a lot of rain, and a low area of the soybean field has become wetter than usual. The machine is currently running at 60%, but you want to cut that in half for this area of the field. Refer to Figure 149-1.

Normal System Operation:

- Machine: On at 0°
- Water: On
- Direction: Both
- Percent: 60

Program First Sector:

- Start Angle: 45°
- End Angle: 80°
- Direction: Both
- Command: Percent of Depth = 50

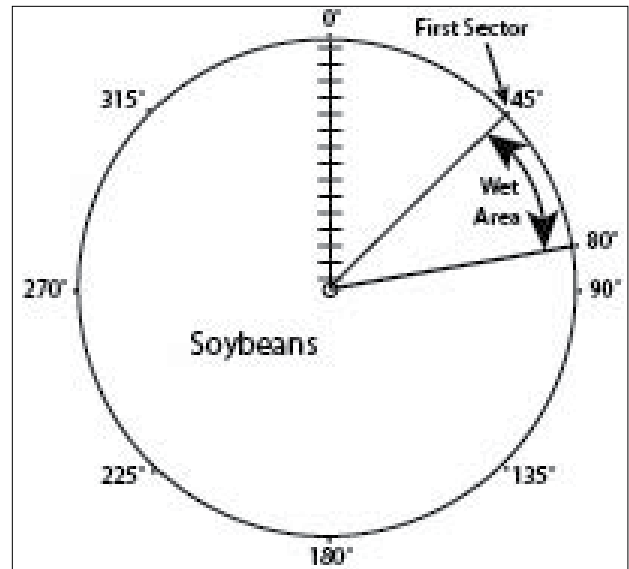

Figure 149-1

Programming the First Sector

To program the sector for % of Depth follow these steps:

1. Push **Menu**, **Programs**, and **Sector Programs** to view the Sector Programs screen. Refer to Figure 149-2.
2. Push the **Add Program** button corresponding to Program 1.
3. Select the **Start Angle** field. Refer to Figure 149-3.
4. Using the numeric keypad, enter **4, 5, 0** for 45.0° as the start angle of the new sector.
5. Push **Enter** to retain the value.
6. Select the **End Angle** field.
7. Using the numeric keypad, enter **8, 0, 0**, for 80.0° as the end angle of the new sector.
8. Push **Enter** to retain the value.
9. Select the **Direction** drop-down menu and choose **Both**.
10. Push the **Save** button to begin choosing commands.

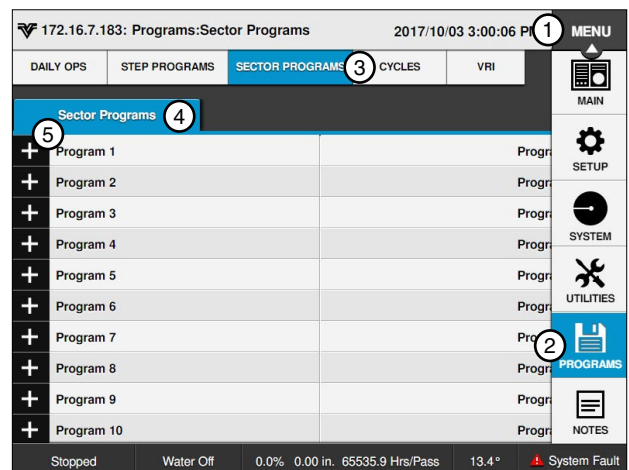

Figure 149-2 1. Menu 2. Programs 3. Sector Programs 4. Sector Programs 5. Add Program

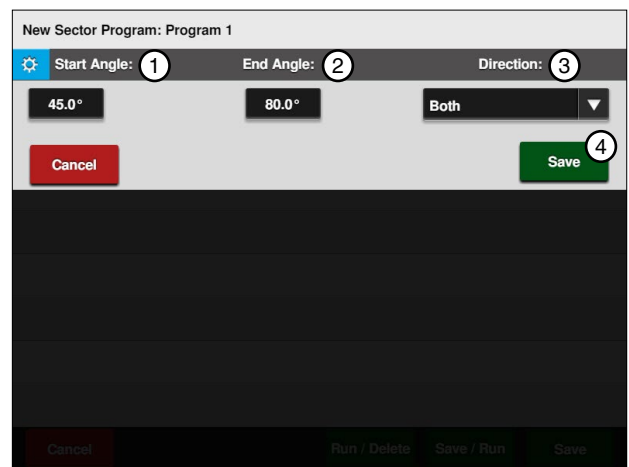

Figure 149-3 1. Start Angle 2. End Angle 3. Direction 4. Save

Programs / Sector Program Examples

Programming the First Sector (Continued)

11. To choose the % of Depth command for this sector follow these steps:

- Select the **Choose Command** drop-down menu and choose **% of Depth**. Refer to Figure 150-1.
- Select the % field, enter **5, 0** for 50%.
- Push **Enter** to retain the value.

12. Finish the program by selecting one of the following. Refer to Figure 150-1.

- Push **Save** to save the program.
- Push **Save & Run** to save and then run the program.
- Push **Run & Delete** to run and then delete the program.
- Push **Cancel** to return to the main step program screen.

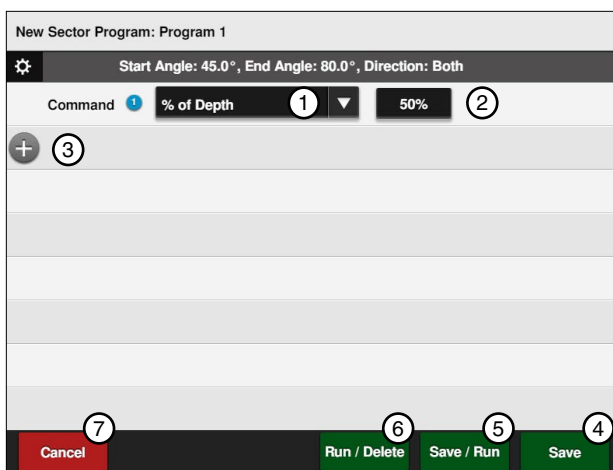

Figure 150-1 1. % of Depth Command 5. Save & Run
2. Percent 6. Run & Delete
3. Add Command 7. Cancel
4. Save

Cycles

The Cycles menu allows the operator to run complete irrigation cycles at specified intervals in days. For example, the operator may want to irrigate every 3 days or 5 days. This feature uses the START\$ programs. Refer to Figure 151-1.

START\$ Interval

START\$ Interval is used to run the system to the SIS location and the stop. The machine will then restart a number of days later, and then stop at the SIS location.

Requirements for an interval restart to occur include.

1. SIS must be turned on.
2. Must run to SIS and stop at SIS location.
3. A START\$ must be programmed.

START\$ Interval Enable/Disable

The START\$ Interval checkbox is used to enable and disable the START\$ Interval.

1. Check the **START\$ Interval** checkbox to enable START\$ Interval.
2. Uncheck the **START\$ Interval** checkbox to disable it.

When the START\$ Interval is enabled the Next Start date at the bottom of the START\$ Interval screen will then show the next date that this cycle will run. Refer to Figure 151-1.

Stop-In-Slot (SIS)

The Stop-In-Slot feature is used to stop the machine at a SIS location in the field that you selected, such as the pivot road.

1. Select the **SIS** field.
2. Enter the desired degree on the numeric keypad at which the machine will stop,
3. Push **Enter** to retain the value.
4. Push the **SIS Off** button to turn this feature on.

NOTE

- The Stop-In-Slot bypass is used as a counter by the computer to signal when a cycle has been completed. During each cycle, the machine **MUST** pass the Stop-In-Slot position in order to execute the **CYCLES\$** program again.

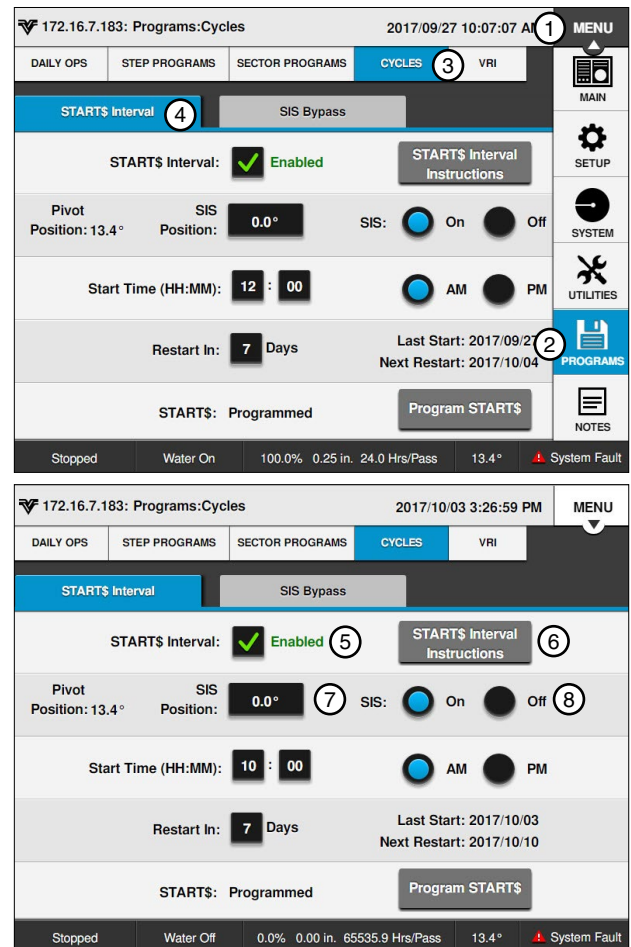

Figure 151-1 1. Menu 2. Programs 3. Cycles 4. Start\$ Interval 5. START\$ Interval Checkbox 6. START\$ Interval Instructions 7. SIS Position 8. SIS Off

Programs / Cycles

START\$ Interval (Continued)

Start Time (HH:MM)

The Start Time feature is used to set the time at which the cycle will start on the preset days it is set up to start.

1. Select the **Start Time** field.
2. Enter the desired Start Time on the numeric keypad at which the machine will start.
3. Select **AM** or **PM**.
4. Push **Enter** to retain the value.

Restart in (Days)

This feature is used to set the number of days at which the cycle will restart.

1. Select the **Restart in (Days)** field.
2. Enter the desired number of days on the numeric keypad at which the machine will restart the cycle.
3. Push **Enter** to retain the value.

Program START\$

The START\$ program is used to command how the machine should start, and is used by the Power Restart function, CYCLE\$, and Daily Ops. For more information on Program START\$ refer to "START\$ Program" on page 91 and "Using Write START\$" on page 92 in the Daily Ops Section.

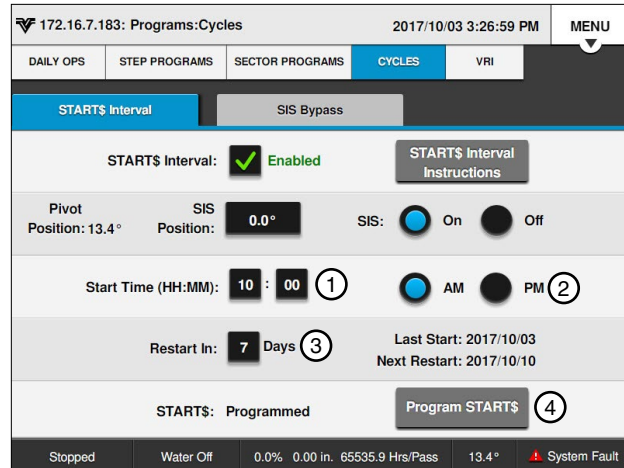

Figure 152-1 1. Start Time 3. Restart in (Days)
2. AM or PM 4. Program START\$

SIS Bypass

The Stop-In-Slot Bypass feature is used to run the system to the SIS location and bypass the SIS a defined number of times. Refer to Figure 153-1.

Requirements for a Stop-In-Slot Bypass are:

- SIS must be turned off
- A START\$ must be programmed

To execute the SIS Bypass program follow these steps:

1. Push **Menu**, **Programs**, **Cycles**, and **SIS Bypass** to view the SIS Bypass screen.
2. If necessary, push the **Off** button to turn SIS off.
3. Select the **Number of Times to Bypass SIS** field.
4. Using the numeric keypad, enter the number of times to bypass SIS.
5. Push **Enter** to retain the value.
6. Push the **Run SIS Bypass** button.

NOTE

- **The machine starts immediately after pushing Run SIS Bypass, and executes two complete cycles before stopping.**
- **The Run SIS Bypass button cannot be pushed until SIS is turned Off.**

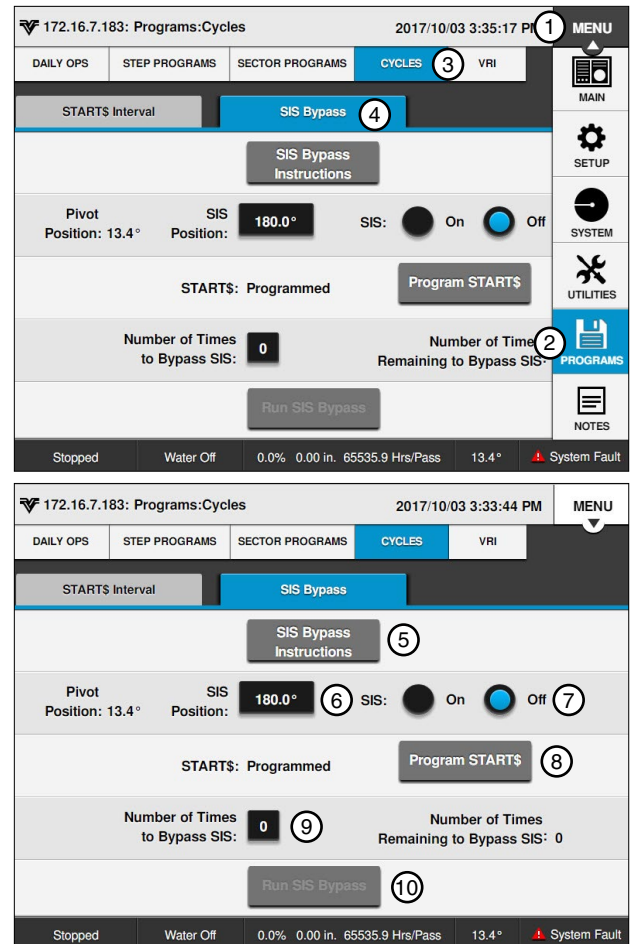

Figure 153-1 1. Menu 2. Programs 3. Cycles 4. SIS Bypass 5. SIS Bypass Instructions 6. SIS Position 7. SIS Off 8. Program Start\$ 9. Number of Times 10. Run SIS Bypass

Programs / Cycles

Example 1. START\$ Interval - Interval in Days

START\$ Interval allows the operator to run complete irrigation cycles at specified intervals in days. For example, the operator may want to irrigate every 3 days or 5 days. This feature uses the START\$, STOP\$, and CYCLE\$ programs.

Expected Conditions

- Delayed START\$ program is written
- STOP\$ program is written
- Machine off at 0°
- Stop-In-Slot is set to 0°
- Stop-In-Slot is on

Program Machine To

- Start at 10:00 AM
- Water On
- Forward, Depth 1.00"
- Depth 0.50" at 180°
- Execute one complete revolution every three days

Setup Cycle Interval

To set up the Cycle Interval for Example 1 follow these steps:

1. Push **Menu**, **Programs**, **Cycles**, and **START\$ Interval** to view the START\$ Interval screen. Refer to Figure 154-1.
2. Check the **START\$ Interval** checkbox to enable START\$ Interval.
3. Select **Start\$ Interval instructions** to view requirements for a Start\$ Interval restart.
4. If necessary, turn **Stop-In-Slot** on.
5. Select the **Start Time (HH:MM)** field, enter **10, 00, 00** for 10:00 and choose **AM**.
6. Select the **Restart in (Days)** field and enter **3** to repeat the cycle every three days, push **Enter** to retain the value.
7. Push the **Program START\$** button and verify there is a delay set.

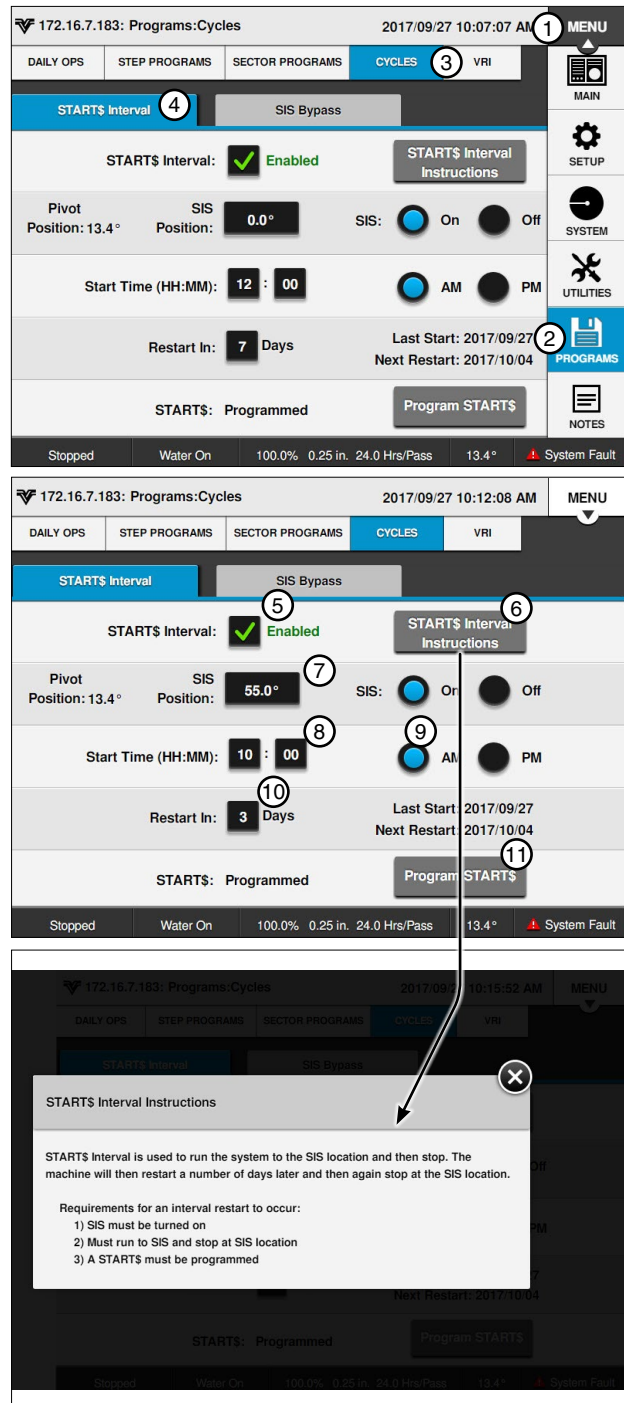

Figure 154-1 1. Menu 7. SIS Position
 2. Programs 8. Start Time
 3. Cycles 9. AM
 4. Start\$ Interval 10. Restart in Days
 5. Start\$ Interval Checkbox 11. Program Start\$
 6. Start\$ Interval Instructions

Example 1. START\$ Interval - Interval in Days (Continued)

Write CYCLE\$ Program

To write the CYCLE\$ program for Example 4 follow these steps:

Program Step 1

1. Push **Menu**, **Programs**, and **Step Programs** to view the Step Programs screen. Refer to Figure 155-1.
2. Push the New Program button for **CYCLES**.
3. Program the Delay condition for this step. Refer to Figure 155-2.
 - a) Select the **Choose Condition** drop-down menu and choose **Delay**.
 - b) Select the **Delay Time** field and enter **0** for 0 seconds, push **Enter** to retain the value.
 - c) Push the **Seconds** button to set the condition as **Seconds**.
 - d) Push the **Save** button to retain the values for the Delay condition.
4. Enter the commands to be executed. Refer to Figure 155-3.
 - e) Select the **Choose Command** drop-down menu and choose **Water**.
 - f) Push the **On** button to set the command to Water On.
 - g) Select the **Add Command** drop-down menu and choose **Direction**.
 - h) Push the **Forward** button to set the command to **Forward**.
 - i) Select the **Add Command** drop-down menu and choose **Depth**.
 - j) Select the **Inches** field, enter **1, 0, 0** for 1.00 inches and push **Enter** to retain the value.
5. Push **Add Step** to add step 2.

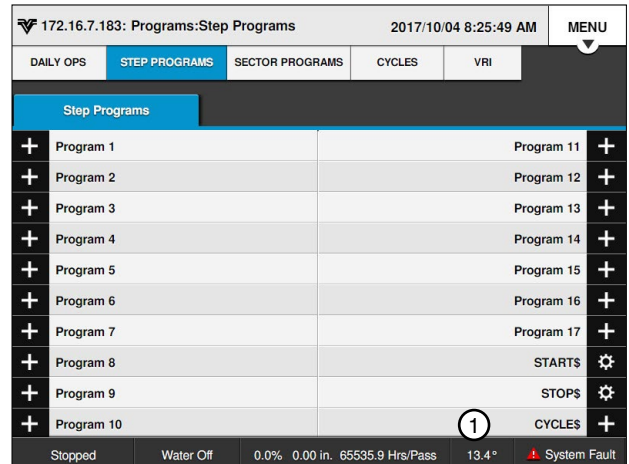

Figure 155-1 1. CYCLES\$

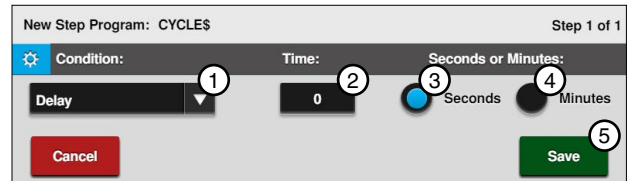

Figure 155-2 1. Delay Condition 4. Minutes
2. Delay Time 5. Enter
3. Seconds

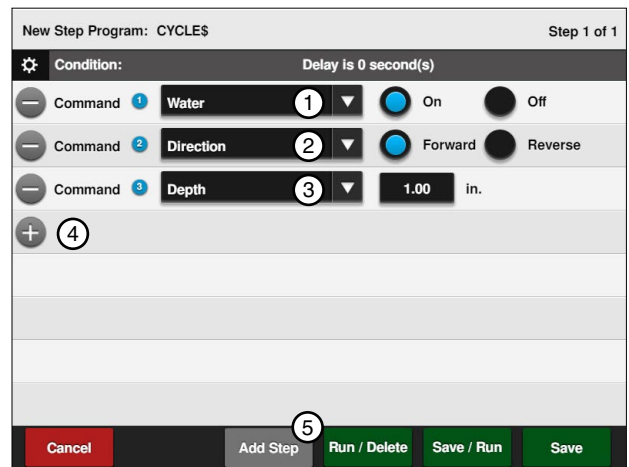

Figure 155-3 1. Water On 4. Add Command
2. Direction Forward 5. Add Step
3. Depth 1.00"

Programs / Cycles

Example 1. START\$ Interval - Interval in Days (Continued)

Program Step 2

6. Program the position condition for this step. Refer to Figure 156-1.
 - k) Select the **Choose Condition** drop-down menu and choose **Position**.
 - l) Select the **Degrees** field, enter **1, 8, 0, 0** for 180.0 degrees and push **Enter** to retain the value.
 - m) Push **Save** to retain the values for the Position condition.
7. Enter the command to be executed at this position. Refer to Figure 156-2.
 - n) Select the **Choose Command** drop-down menu and choose **Depth**.
 - o) Select the **Inches** field, enter **5, 0** for 0.50 inches and push **Enter** to retain the value.

Finish Programming

8. Finish the program by selecting one of the following. Refer to Figure 156-2.
 - Push **Save** to save the program.
 - Push **Save / Run** to save and then run the program.
 - Push **Run / Delete** to run the program once and then delete it.
 - Push **Cancel** to return to the main step program screen.

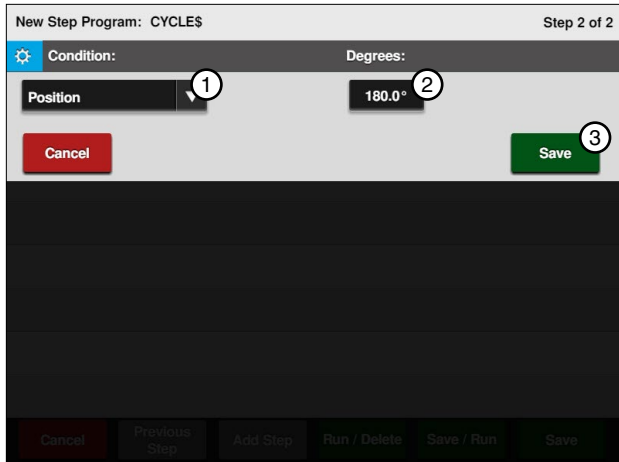

Figure 156-1 1. Position Condition 2. Degrees 3. Save

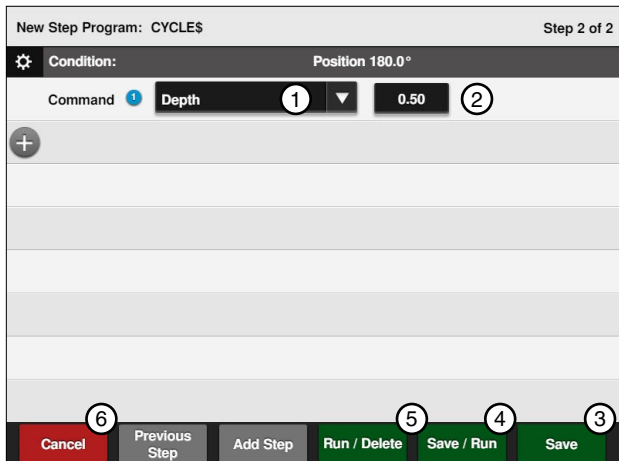

Figure 156-2 1. Depth Command 2. Inches Field 3. Save 4. Save / Run 5. Run / Delete 6. Cancel

VRI-Speed Control

The VRI Speed (VRI-S) Control uses mapping software to divide the field into 180 sectors that relate to the sectors on a prescription map. Each sector has a resolution of two degrees.

At periodic intervals, the control panel uses the VRI-S prescription along with the current Encoder Position, GPS coordinates, or run time to determine and adjust the machine speed for each sector.

Example: If the set application rate is 1.00 in (25.4 mm), and the prescription has a value of 200% in the sector where the center pivot is currently running, the control panel adjusts the speed of the center pivot to achieve an application of 2.00 in (17.78 mm). Center pivot speed cannot exceed 100%.

VRI-S Screen

Use the VRI-S screen to enable or disable the Variable Rate Irrigation Speed (VRI-S) control feature, view the prescriptions, add sectors, or edit sectors. **VRI-S is not available when VRI-Z protocol is enabled.**

A graphic display of the color coded % of depth multiplier settings are shown for the selected prescription.

Push **Menu**, **Programs**, and **VRI** to display the VRI screen. Refer to Figure 157-1.

VRI-S Enable/Disable

VRI-S is only available when VRI-Z or VRI-iS have not been configured in a Comm Port. To enable or disable VRI-S follow these steps:

1. Push **Menu**, **Programs**, **VRI**, and **VRI-S** to display the VRI-S screen. Refer to Figure 157-1.
2. To enable VRI-S, check the VRI-S checkbox.
 - To disable VRI-S, uncheck the VRI-S checkbox.

NOTE

- When VRI-S is enabled, Cruise Control is automatically disabled.
- The VRI screen functions as a VRI-S screen unless VRI-Z or VRI-iS protocol has been enabled in Comm Port Settings.

Rx

There are five default prescriptions set from 0 to 360 degrees with a % of depth multiplier of 100%.

Other prescriptions can be uploaded to the control panel to replace the default prescriptions. Up to five prescriptions can be stored.

To select the Rx # prescription number follow these steps:

1. Push **Menu**, **Programs**, **VRI**, and **VRI-S** to display the VRI-S screen. Refer to Figure 157-1.
2. Select the **Rx #** drop-down menu.
3. Choose the Rx # options.

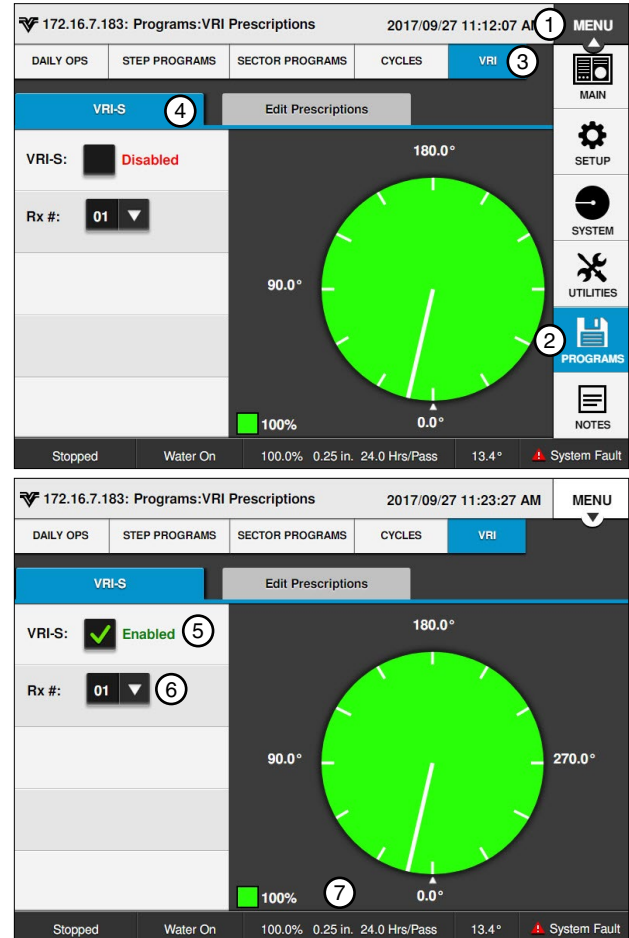

Figure 157-1 1. Menu
2. Programs
3. VRI
4. VRI-S
5. VRI-S Enabled
6. Rx # Drop-Down
7. % of Depth

Programs / VRI-S

Main Screen Status

When VRI-S is enabled and the machine is running with water on, the VRI icon and VRI-S alternate with the Programs icon and Programs in the status area of the Main screen. Refer to Figure 158-1.

Irrigation Prescription

A prescription is created using a computer and the Prescription software. See Figure 158-2.

The VRI-Speed prescription can have up to 180 sectors each with a resolution of 2 degrees.

Prescription Upload Methods

Listed below are products along with several methods for uploading prescriptions to the control panel based on the product being used.

- VRI Prescription Software including Prescription Loader: Save a VRI prescription created with the prescription software program to a folder on the computer hard drive. This may require an updated version of the VRI Software.
- BaseStation3: Access a VRI prescription saved by Prescription Loader to a folder on the computer hard drive for upload to a control panel.
- WagNet.net website: Access a VRI prescription created with the prescription software from a folder on the computer hard drive for upload through a wireless connection to a control panel with ICON Link.

Position Values

VRI-S works with the Position Encoder, GPS position, or Runtime Fallback Position.

- When the Position Encoder is activated, position values are provided by the Position Encoder, the GPS positioning, or the Runtime Fallback Position.
- When the GPS Position is activated, position values are provided by the GPS antenna. If there is no GPS signal, the position values are calculated through the Runtime Fallback Position.



Figure 158-1 1. Programs Icon
2. VRI-S Icon

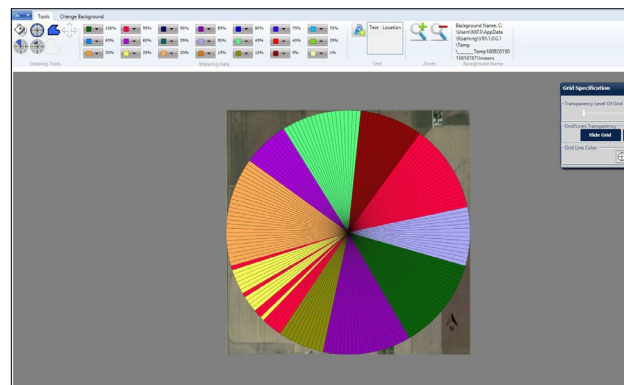

Figure 158-2 Example prescription as shown using VRI prescription software. The prescription in graphic form is not seen on the control panel.

Configure Prescriptions

The Configure Prescription button is used to select, edit, review, and load prescription numbers and sectors. Push **Menu**, **Programs**, **VRI-S**, and **Edit Prescriptions** to view the Edit Prescriptions screen. Refer to Figures 159-1 and 159-2.

Edit Sectors

To set or change the sector positions and depth multiplier of the prescription while in the field follow these steps:

1. Push **Menu**, **Programs**, **VRI**, and **VRI-S** to display the VRI-S screen. Refer to Figure 159-1.
2. Push the **Edit Prescriptions** tab.
3. Choose the Rx # (prescription) number to edit.
4. Push the **Edit Sectors** button to display the Edit Sectors screen. Refer to Figure 159-2.
5. Select the **Left Angle** field.
6. Using the numeric keypad, enter the start angle of the sector. The start angle value is automatically rounded down to the nearest even number. Example: A start angle of 181° is rounded up to 182°.
7. Push **Enter** to retain the value.
8. Select the **Right Angle** field.
9. Using the numeric keypad, enter the end angle of the sector. The end angle value is automatically rounded up to the nearest even number. Example: An end angle of 195° is rounded up to 196°.
10. Push **Enter** to retain the value.
11. Select the **% of Depth** field.
12. Repeat steps 2 through 9 for other sectors that require different water application rates.
13. Using the numeric keypad, enter the % of depth multiplier (1 to 255), and push **Enter** to retain the value.
14. Push the **Save** button to save the changes, or push the **Cancel** button to cancel the entries and exit to VRI-S screen.

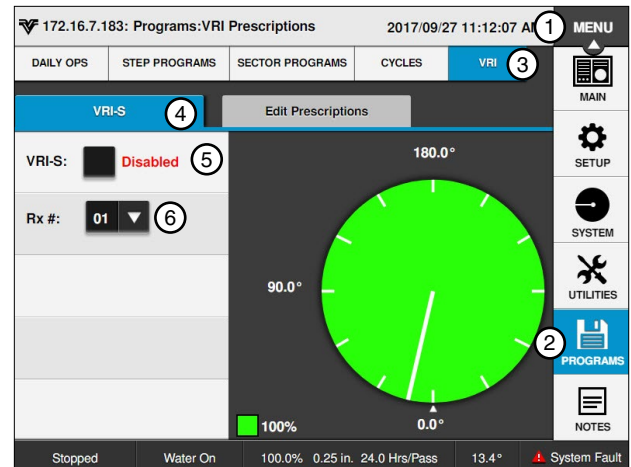

Figure 159-1 1. Menu
2. Programs
3. VRI
4. VRI-S
5. VRI-S Enable/Disable
6. Rx#

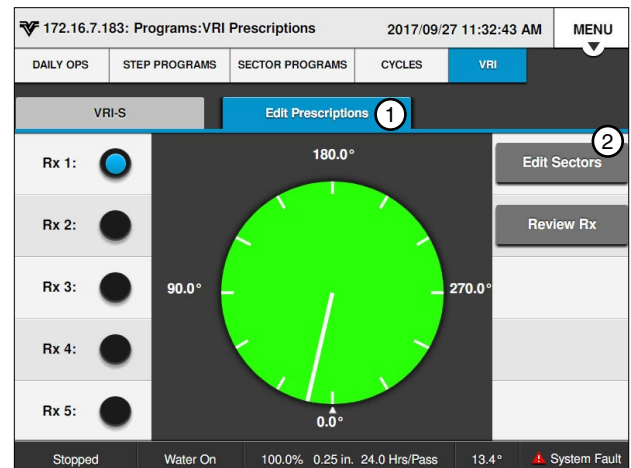

Figure 159-2 1. Edit Prescriptions
2. Edit Sectors

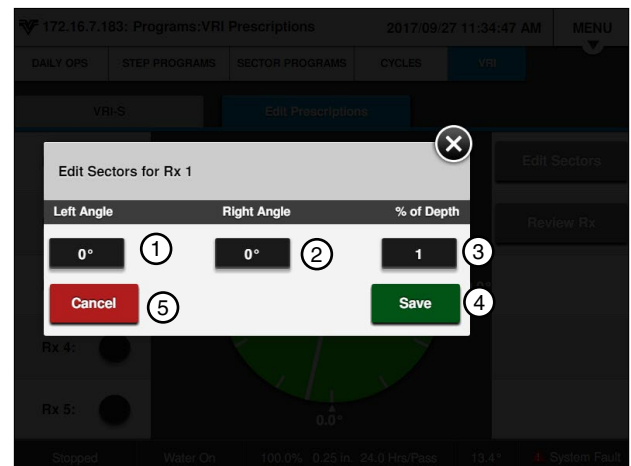

Figure 159-3 1. Left Angle
2. Right Angle
3. % of Depth
4. Save
5. Cancel

Programs / VRI-S

Review Rx

The Review Rx button is used to review the % of depth multiplier for each sector of the selected Rx #. Refer to Figure 160-1.

To review the % of depth multiplier for each sector of a selected Rx # follow these steps:

1. Push **Menu**, **Programs**, **VRI**, and **Edit Prescriptions** to display the Edit Prescriptions. Refer to Figure 160-1.
2. Choose the Rx # (prescription) number to review.
3. Push the **Review Rx** button to display the Review Rx Screen. Refer to Figure 160-2.
4. Push the Next/Previous buttons at the bottom of the Review Rx screen to review additional % of depth multiplier settings.
5. Push **Cancel** to return to the Configure Prescriptions screen.

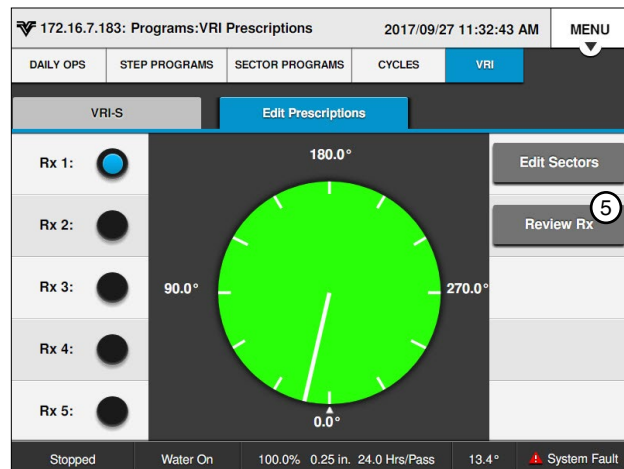
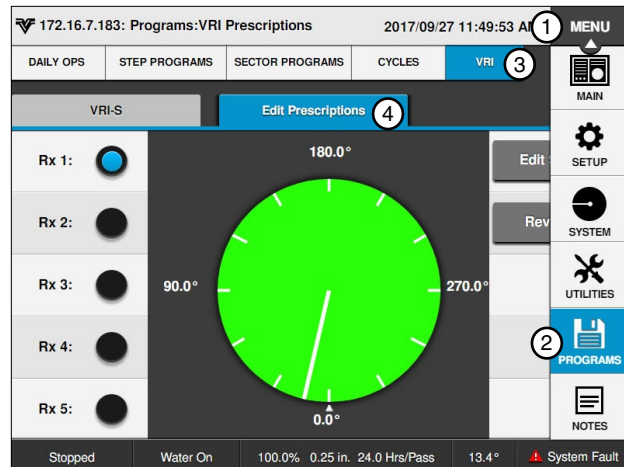

Figure 160-1 1. Menu 4. Edit Prescriptions
2. Programs 5. Review Rx
3. VRI

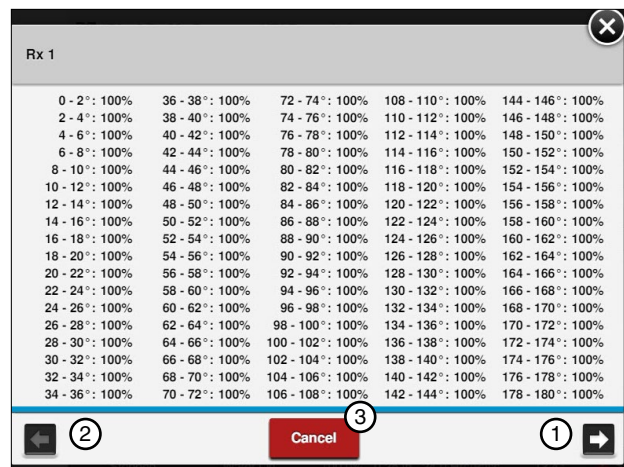

Figure 160-2 1. Next
2. Previous
3. Cancel

VRI-Zone Control

The VRI-Zone (VRI-Z) Control option uses mapping software and hardware to divide the irrigation machine sprinklers and the field into sprinkler zones that relate to the sectors on a sprinkler map. Each sprinkler zone has an ID number associated with a VRI tower box valve that controls one or more sprinklers. There can be up to 30 sprinkler banks, this is not a sector.

Each VRI tower box can support up to 30 sprinkler banks. Each VRI tower box PLC modem card has an ID number. There can be up to 15 VRI tower boxes.

When the control panel safety circuit is complete, the PLC Modem Card (OPMC) in each VRI tower box powers up and begins receiving information from the control panel. As the machine runs, each sprinkler bank is pulsed on and off based on its cycle time and Percent On setting (duty cycle).

At periodic intervals, the control panel uses the sprinkler map along with the current encoder position, GPS coordinates, or run time to determine the Percent On for each sprinkler bank. It then sends a set sprinkler messages with the current Percent On for each sprinkler bank along with the current cycle time to the OPMC boards.

NOTE

- When VRI-Z is enabled, Cruise Control is automatically disabled.
- When VRI-Z protocol has been enabled, the VRI screen functions as a VRI-Z screen.

VRI-Z Screen

VRI-Z Enable/Disable

VRI-Z is only available when VRI-Z has been configured in a Comm Port. After the control panel has been set up, the VRI-Z option can be enabled or disabled by doing the following.

1. Push **Menu, Programs, VRI** and **VRI-Z** to display the VRI-Z screen. Refer to Figure 161-1.
2. Check the VRI-Z checkbox to enable VRI-Z.
 - Uncheck the VRI-Z checkbox to disable VRI-Z.

Main Screen Status

When VRI-Z is enabled and the machine is running with water on, the VRI icon and VRI-Z alternate with the Programs icon and Programs in the status area of the Main screen. Refer to Figure 161-2.

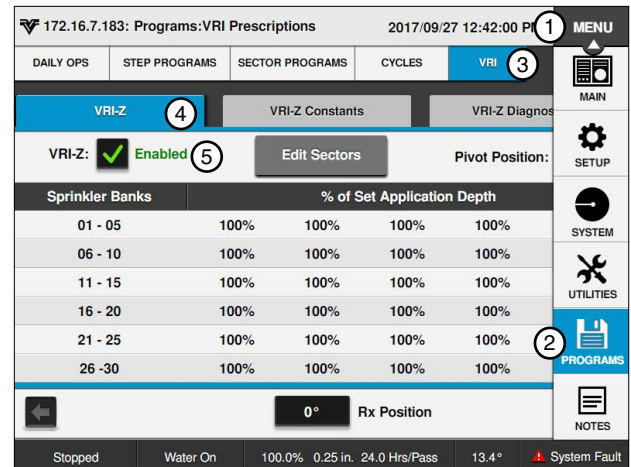

Figure 161-1 1. Menu 2. Programs 3. VRI 4. VRI-Z 5. VRI-Z Checkbox



Figure 161-2 1. Programs Icon 2. VRI-Z Icon

Programs / VRI-Z

Irrigation Prescription

The prescription is created using a computer and the VRI Prescription software. Refer to Figure 162-1.

NOTE

A good understanding of the overall hydraulics of the center pivot, pipeline, if any, and pump is necessary to ensure equipment is not damaged by shutting off too many zones at once, thereby decreasing flow to less than the Low Flow Limit. Most pumps experience an increase in Pressure as the flow is decreased. The Low Flow Limit must be determined in order to calculate the maximum changes that can be made. A variable speed pump is a good option. Contact your Valley dealer if you have questions.

Prescription Upload Methods

Listed below are products along with several methods for uploading prescriptions to the control panel based on the product being used.

- VRI Prescription Software including Prescription Loader: Save a VRI prescription created with the prescription software program to a folder on the computer hard drive.
- BaseStation3: Access a VRI prescription saved by Prescription Loader to a folder on the computer hard drive for upload to a control panel.
- WagNet.net website: Access a VRI prescription created with the prescription software from a folder on the computer hard drive for upload through a wireless connection to a control panel with ICON Link.

Position Values

VRI-Z works with the Position Encoder, GPS position, or Runtime Fallback Position.

- When the Position Encoder is activated, position values are provided by the Position Encoder, the GPS position, or the Runtime Fallback Position.
- When the GPS Position is activated, position values are provided by the GPS antenna. If there is no GPS signal, the position values are calculated through the Runtime Fallback Position.

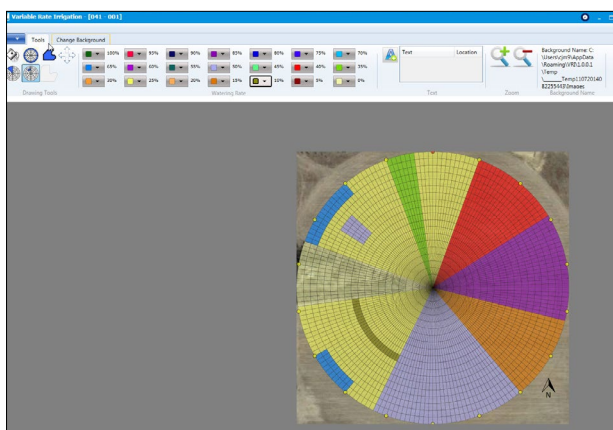

Figure 162-1 Example prescription as shown using VRI Prescription software. The prescription, in graphic form, is not seen on the control panel.

View Prescription

To display the duty cycle for each sprinkler zone at a specific position on the map: Refer to Figure 163-1.

1. Push **Menu**, **Programs**, **VRI**, and **VRI-Z** to display the VRI-Z screen. Refer to Figure 163-1.

The current pivot position in the field is shown in the **Pivot Position** field. In this example, the pivot position is 13.5°.

The prescription position is shown in the **Rx Position** field. In this example, the prescription position being viewed is 20°.

The **% of Set Application Depth** setting for each sprinkler bank/zone when the pivot is at the 20° position in the field is displayed at the bottom of the screen.

2. To adjust the viewed position:
 - Select the **Rx Position** field, enter the position in degrees, and push **Enter**
- or
- Use the **Next** or **Previous** buttons to decrease or Increase or Decrease the viewed position by one degree.

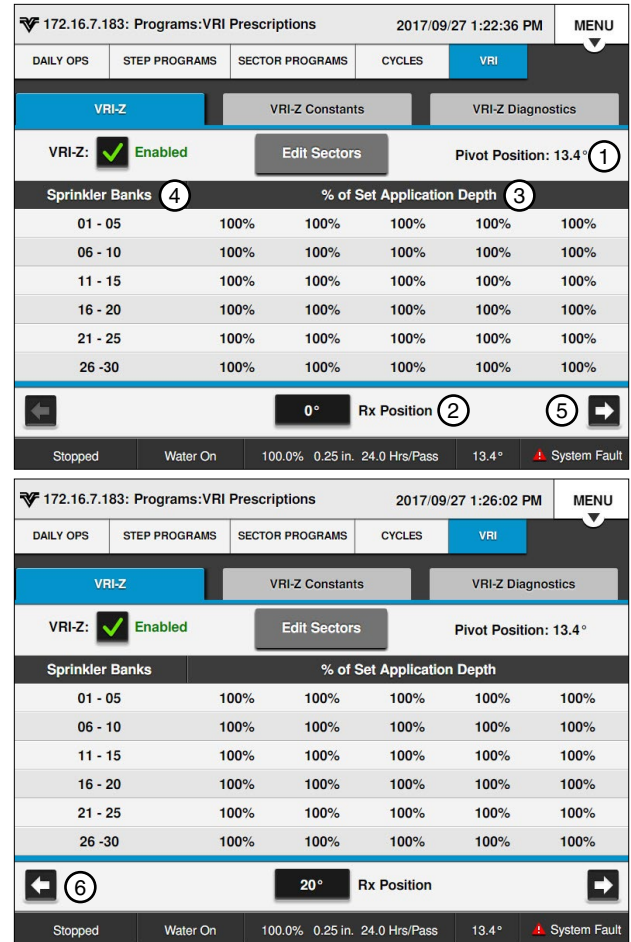

Figure 163-1 1. Pivot Position 4. Sprinkler Banks
2. Rx Position 5. Next
3. % of Set Application Depth 6. Previous

Programs / VRI-Z

Edit Sectors

Used to add or change the sector position and % of Depth of the prescription.

1. Push **Menu**, **Programs**, **VRI**, and **VRI-Z** to display the VRI-Z screen. Refer to Figure 164-1.
2. Push the **Edit Sectors** button.
3. Select the **Sprinkler Bank #** field, and choose the sprinkler bank number to add or change.
4. Select the **Left Angle** field.
5. Using the numeric keypad, enter the left angle of the sector. The left angle value is automatically rounded down to the nearest even number. Example: A left angle of 181° is rounded down to 180°.
6. Push **Enter** to retain the value.
7. Select the **Right Angle** field.
8. Using the numeric keypad, enter the right angle of the sector. The right angle value is automatically rounded up to the nearest even number. Example: An right angle of 195° is rounded up to 196°.
9. Push **Enter** to retain the value.
10. Select the **% of Depth** field.
11. Using the numeric keypad, enter the % of depth multiplier (0% to 100%), and push **Enter**.
12. Repeat steps 2 through 11 for changing other sectors.
13. Push the **Save** button to save the changes, or push the **Cancel** button to cancel the entries and exit to VRI-Z screen.

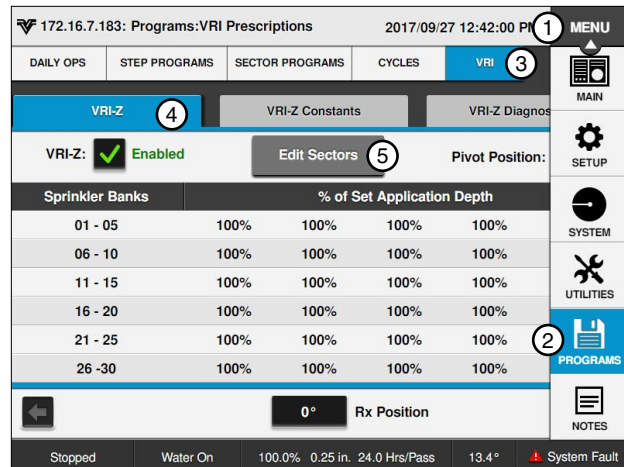

Figure 164-1 1. Menu 4. VRI-Z
2. Programs 5. Edit Sectors
3. VRI

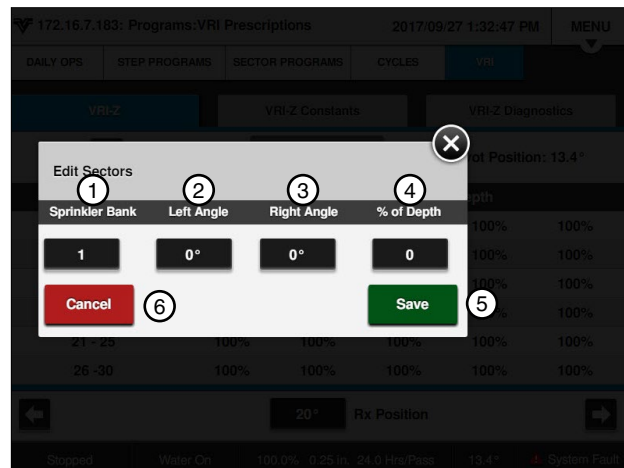

Figure 164-2 1. Sprinkler Bank 4. % of Depth
2. Left Angle 5. Save
3. Right Angle 6. Cancel

VRI-Z Constants

Re-synchronize Valve Duty Cycle

When the valve re-synchronize pressure is reached, the duty cycles of all sprinkler zones starts over. All odd numbered zones start on the off part of the cycle, and all even numbered zones start on the on part of the cycle.

Valve Resync Pressure (PSI)

Valve Resync Pressure is used to monitor water pressure, and re-synchronizes the duty cycle of all sprinkler zones. When the valve re-synchronize pressure is reached, the duty cycles of all sprinkler zones start over. All the odd numbered zones start on the off part of the cycle, and all even numbered zones start on the on part of the cycle.

1. Push **Menu, Programs, VRI, and VRI-Z Constants** to display the VRI-Z Constants screen. Refer to Figure 165-1.

The Valve Resync Pressure field displays the current resync pressure in psi (kPa).

2. To change the valve resync pressure, select the **Valve Resync Pressure** field.
3. Using the numeric keypad, enter a new resync pressure value. The range is 1-999 psi (6.90-6887.90 kPa). The default is 60 psi (413.7 kPa).

Sprinkler Banks

The number of sprinkler banks constant is used to set the number of sprinkler zones. This is required so that the control panel knows how many tower boxes it must communicate with. For example, If there are 13 sprinkler zones, then the control panel communicates with tower boxes with an ID from 1-7.

1. Push **Menu, Programs, VRI, and VRI-Z Constants** to display the VRI-Z Constants screen. Refer to Figure 165-1.

The **Number of Sprinkler Banks** field displays the current number of sprinkler banks. Refer to Figure 165-1.

2. To change the number of sprinkler banks, select the **Number of Sprinkler Banks** field and enter the number of sprinkler banks for this application. The range is 1-30 sprinkler zones. The default is 1.

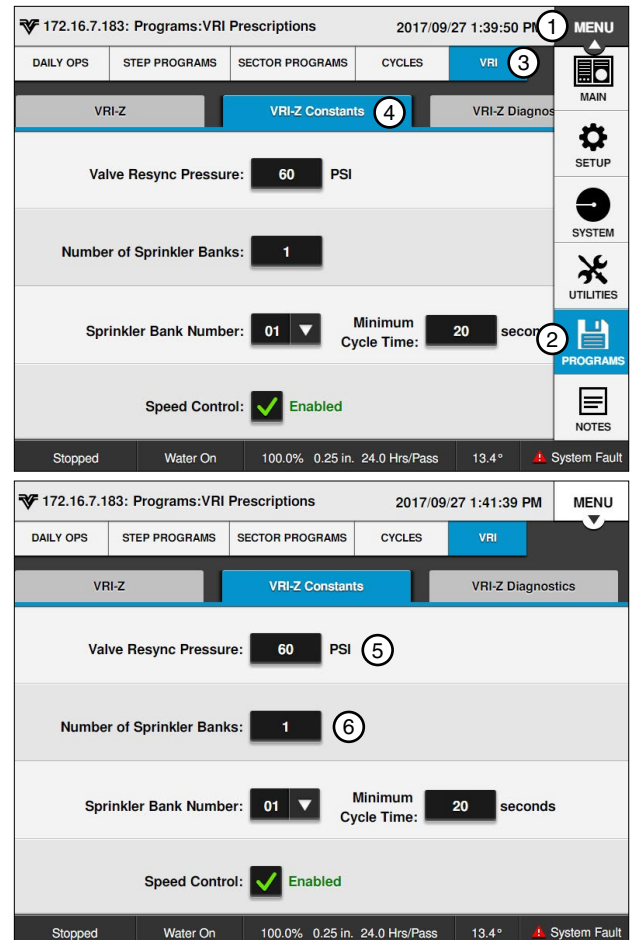

Figure 165-1 1. Menu 4. VRI-Z Constants
2. Programs 5. Valve Resync Pressure
3. VRI 6. Number of Sprinkler Banks

Programs / VRI-Z

VRI-Z Constants (Continued)

Minimum Cycle Time

The minimum cycle time function is used to view and change the sprinkler zone minimum valve cycle time.

1. Push **Menu**, **Programs**, **VRI**, and **VRI-Z Constants** to display the VRI-Z Constants screen. Refer to Figure 166-1.

The minimum cycle time is displayed in seconds for the corresponding sprinkler bank number.

2. To change the minimum cycle time, select the **Sprinkler Bank Number** field and enter the number of sprinklers using the numeric keypad.
3. Select the **Min Cycle Time (seconds)** field, and enter the minimum cycle time value using the numeric keypad. The range is 1-999 seconds. The default is 20 seconds. Refer to Figure 166-1.
4. Check the Speed Control checkbox to enable Speed Control.
 - Uncheck the Speed checkbox to disable Speed Control.

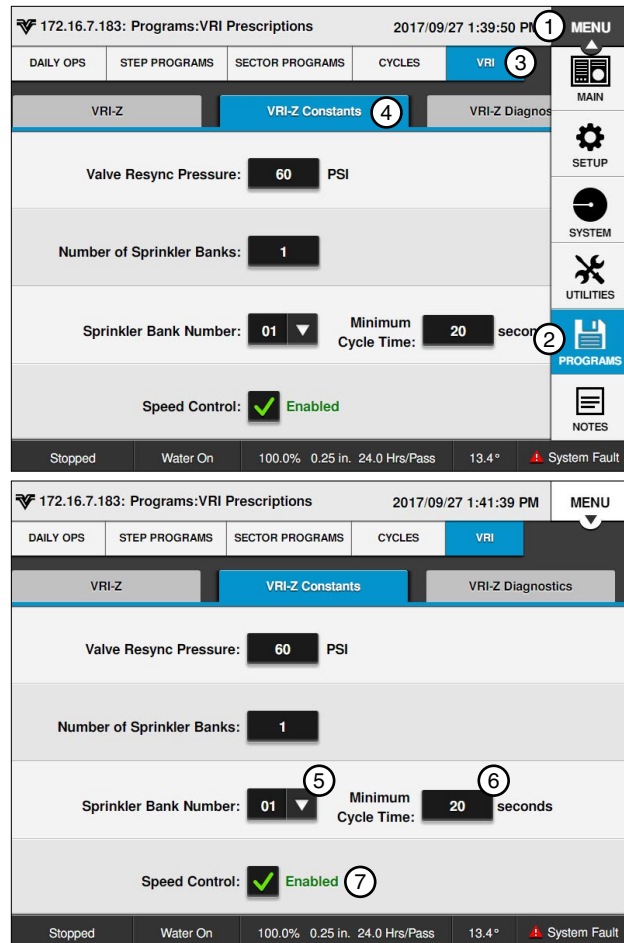

Figure 166-1 1. Menu
2. Programs
3. VRI
4. VRI-Z Constants
5. Sprinkler Bank Number
6. Minimum Cycle Time
7. Speed Control

VRI-Z Diagnostics System Shutdown

The control panel monitors the pressure and flow rate (flow rate requires a flow meter). If the system pressure exceeds the High Pressure value, entered on the Pump screen, for three seconds, the system shuts down. Likewise, if the flow rate is less than the user-entered Low Flow Limit after the system operating pressure is above the low pressure limit, the system shuts down. A system fault occurs in the event of a shutdown.

Sprinkler Bank Off

This diagnostic is used to test sprinkler zones for proper operation. This feature turns all sprinkler banks on. Then, it turns the sprinkler bank number entered off.

This setting is maintained for five minutes, or until a different sprinkler bank is commanded off. After five minutes, the control panel resorts back to the programmed settings.

1. Push **Menu**, **Programs**, **VRI**, and **VRI-Z Diagnostics** to display the VRI-Z Diagnostics screen. Refer to Figure 167-1.
2. Select the **Bank** field and choose the sprinkler bank number to turn off.
3. Push the **Bank Switch** to on to begin the test.

Valve Resync

Use Valve Resync to manually re-synchronize the duty cycle of all sprinkler banks.

The duty cycles of all sprinkler banks start over. All odd numbered banks start on the off part of the cycle, and all even numbered banks start on the on part of the cycle.

1. Push **Menu**, **Programs**, **VRI**, and **VRI-Z Diagnostics** to display the VRI-Z Diagnostics screen. Refer to Figure 167-1.
2. Push the **Resync** button to re-synchronize.

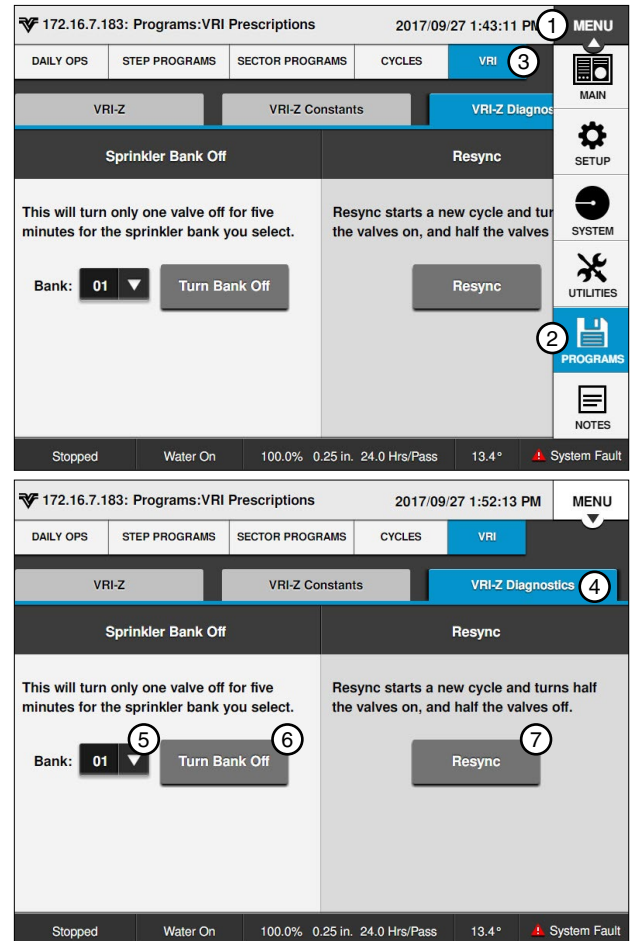

Figure 167-1 1. Menu 5. Bank
2. Programs 6. Bank Switch
3. VRI 7. Resync
4. VRI-Z Diagnostics

Programs / VRI-Z

VRI-Z Overview

The pages in this section provide a brief description of the Valley Variable Rate Irrigation (VRI) components and controls.

VRI Tower Box

Each VRI tower box contains an PLC Modem Card (OPMC) and two solenoid valves. Refer to Figure 168-1.

The control panel sends messages to the OPMC that provide the current percent on for control of each solenoid valve. VRI tower boxes are usually installed on the span pipe close to the drive unit.

Water Filter

The water filter filters water going to the solenoid valves in the tower box. Refer to Figure 168-1.

Each water filter supplies water to both solenoids' valves on one VRI tower box.

Sprinkler Valve

One or more Aquamatic sprinkler valves are opened and closed by one solenoid valve in the VRI tower box. A plastic tube connects each Aquamatic sprinkler valve to a solenoid valve. Refer to Figure 168-2.

The Aquamatic sprinkler valve used in the VRI application does not have a drain.

A typical plumbing configuration for regions where the temperature during the winter months drops below 40°F (4°C), and/or the growing season is six months is shown in Figure 168-2.

- The valve is mounted horizontally which allows water to drain out of the valve and plumbing reducing the possibility of damage due to freezing. Refer to Figure 168-2.
- Other plumbing configurations that might be used in regions where the temperature during the winter months stays above 40°F (4°C) are shown in Figure 168-3.
- The valve is mounted vertically which does not allow water to drain out of the valve or U-pipe. If temperatures drops below 40°F (4°C), turn the VRI option off and run the machine with water, this opens the valves (which can be visually inspected) to drain water and reduce the possibility of damage due to freezing. Refer to Figure 168-3.

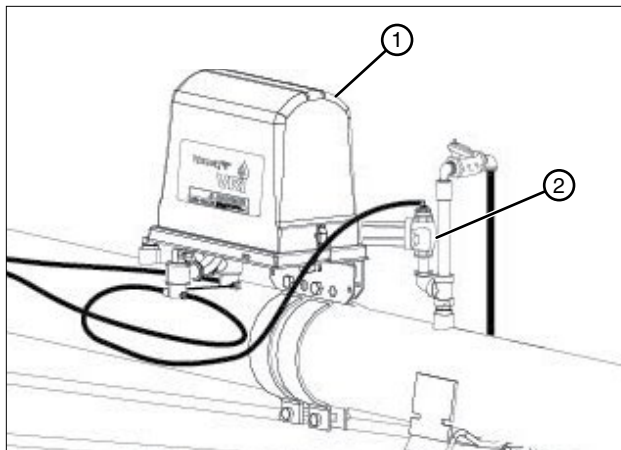

Figure 168-1 1. Aquamatic Valve
2. Plastic Tube

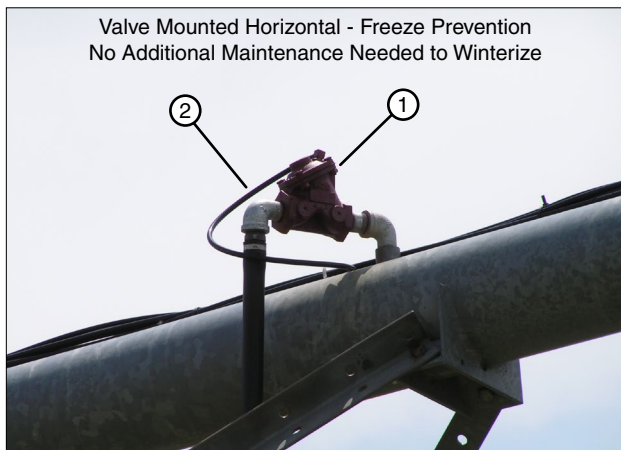

Figure 168-2 1. Aquamatic Valve
2. Plastic Tube

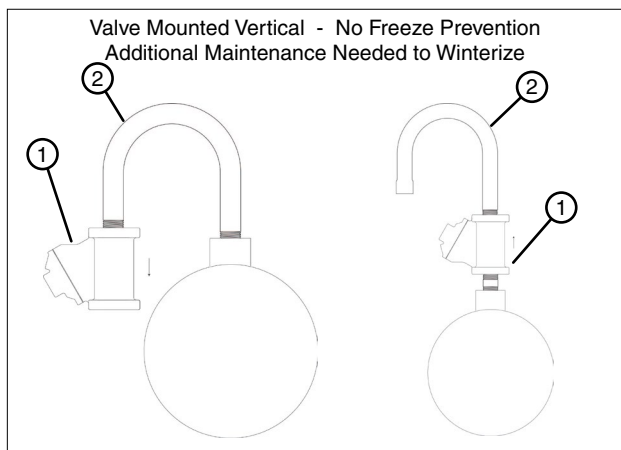

Figure 168-3 1. Aquamatic Valve
2. U-Pipe

VRI-Z Overview (Continued)

Stand Pipe Option

The Stand Pipe Option is used to reduce off duty cycle lag time in extreme applications where it takes more than a few seconds for sprinkler valves in a specific zone to close. Refer to Figure 169-1.

The ball valve on the bottom of the stand pipe must be closed during operation.

In regions where the temperature during the winter months drops below 40°F (4°C), and/or the growing season is six months or less, drain the stand pipe at the end of season.

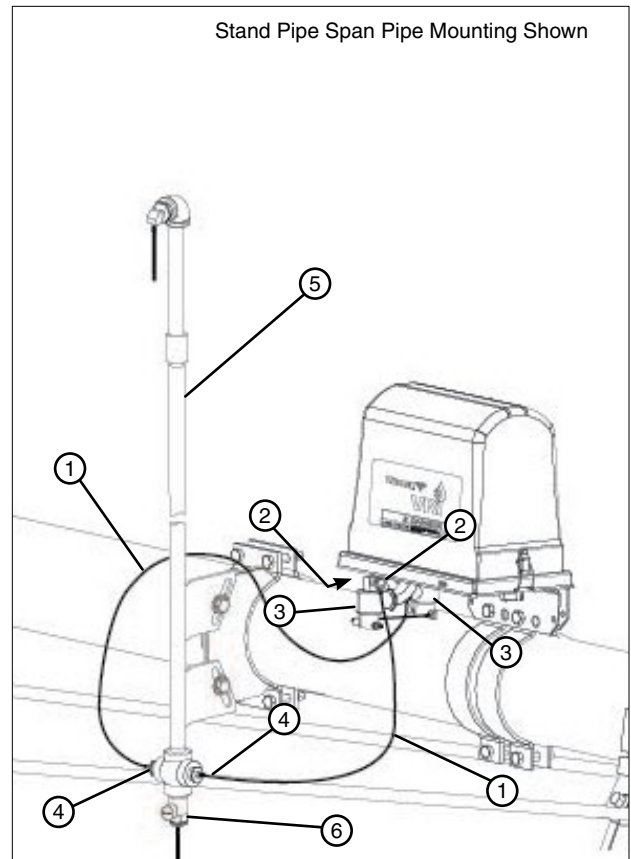

Figure 169-1 1. Plastic Tubing 2. Exhaust Port 3. Solenoid 4. Fitting 5. Stand Pipe 6. Ball Valve

Programs / VRI-iS

VRI-individual Sprinkler (VRI-iS) Control

The VRI-Individual Sprinkler (VRI-iS) Control option uses mapping software and hardware to divide the irrigation machine sprinklers and the field into sectors/sprinkler zones that relate to the sectors on a sprinkler map. Each sprinkler valve is assigned an ID number by the control panel. There can be up to 240 sprinklers.

As the machine runs, each sprinkler is pulsed on and off based on its cycle time and percent on setting (duty cycle).

The control panel uses the sprinkler map along with the current GPS coordinates, or run time to determine the percent on for each sprinkler. It then sends sprinkler messages with the current percent on for each sprinkler along with the current cycle time.

NOTE

- When VRI-iS is enabled, Cruise Control is automatically disabled.
- When VRI-iS protocol has been enabled, the VRI screen functions as a VRI-iS screen.

VRI-iS Screen

Use the VRI-iS screen to enable VRI-iS, view prescriptions, view the map, adjust parameters, and add sectors.

- Push **Menu**, **Programs**, and **VRI** to access the VRI-iS screen. Refer to Figure 170-1.

VRI-iS Enable/Disable

VRI-iS is only available when VRI-iS has been configured in a Comm Port. After the control panel has been set up, the VRI-iS option can be enabled or disabled by doing the following:

1. Push **Menu**, **Programs**, and **VRI** to access the VRI-iS screen. Refer to Figure 170-1.
2. Check the VRI-iS checkbox to enable VRI-iS.
 - Uncheck the VRI-iS checkbox to disable VRI-iS.

NOTE

- When VRI-iS is turned on, cruise control is automatically disabled.
- When VRI-iS protocol has been enabled, the VRI screen functions as a VRI-iS screen.

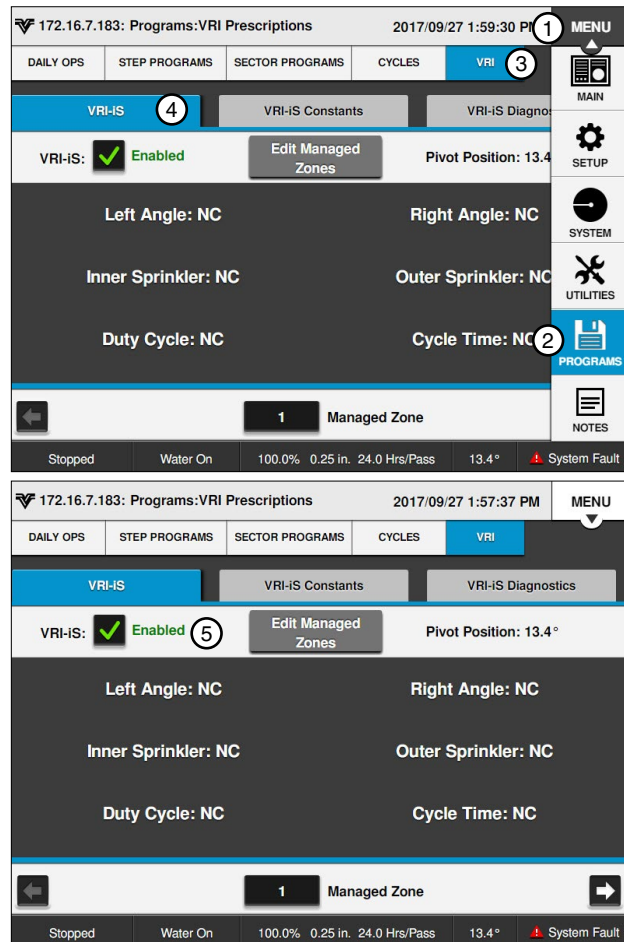

Figure 170-1 1. Menu 2. Programs 3. VRI 4. VRI-iS 5. VRI-iS Enabled

Main Screen Status

When VRI-iS is enabled and the machine is running with water on, the VRI icon and VRI-iS alternate with the Programs icon and Programs in the status area of the Main screen. Refer to Figure 171-1.

Irrigation Prescription

A prescription is created using a computer and the Prescription software.

The prescription is limited to 1300 managed zones and 495 valves, with a resolution of 0.1 degrees for each zone. The Percent On values in the sprinkler map can be set from 0 to 100 percent in five percent steps. Refer to Figure 171-2.

NOTE

A good understanding of the overall hydraulics of the center pivot, pipeline, if any, and pump is necessary to ensure equipment is not damaged by shutting off too many zones at once, thereby decreasing flow to less than the minimum flow rate.

Most pumps experience an increase in pressure as the flow is decreased. The minimum flow rate must be determined in order to calculate the maximum changes that can be made.

A variable speed pump is a good option. Contact your Valley dealer if you have questions.

Prescription Upload Methods

Listed below are products along with several methods for uploading prescriptions to the control panel based on the product being used.

- VRI Prescription Software including Prescription Loader: Save a VRI prescription created with the prescription software program to a folder on the computer hard drive.
- BaseStation3: Access a VRI prescription saved by Prescription Loader to a folder on the computer hard drive for upload to a control panel.
- WagNet.net web site: Access a VRI prescription created with the prescription software from a folder on the computer hard drive for upload through a wireless connection to a control panel with ICON Link.

Position Values

VRI-iS works only with GPS Position:

- Position values are provided by the GPS receiver. But, when there is no GPS signal, the position resorts to using backup Runtime. An E18 error is recorded.



Figure 171-1 1. Programs Icon
2. VRI-iS Icon

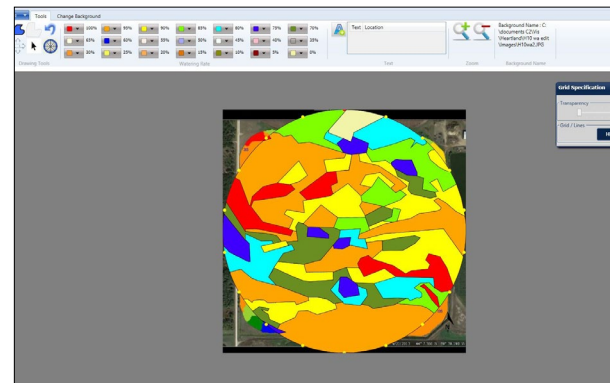

Figure 171-2 Example prescription as shown using VRI prescription software. The prescription in graphic form is not seen on the ICON control panel.

Programs / VRI-iS

View Prescription

To display the duty cycle for each sprinkler zone at a specific position on the map:

1. Push **Menu**, **Programs**, and **VRI** for the VRI-iS screen. Refer to Figure 172-1.

NOTE

- The displayed Cycle Time is calculated using a % Timer value of 100%.

Adjusting the viewed position:

- Push the **Next** or **Previous** button to increase or decrease the viewed Management Zone by 1.
- or
- Select the **Managed Zone** field and enter the zone using the numeric keypad.

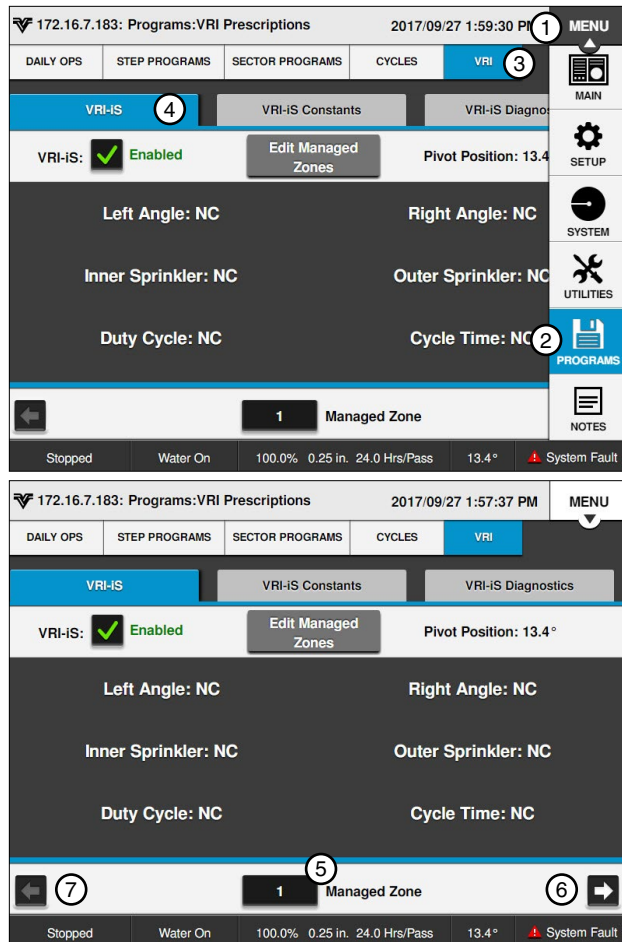

Figure 172-1 1. Menu 5. Managed Zone
2. Programs 6. Next
3. VRI 7. Previous
4. VRI-iS

Edit Managed Zones

Used to change the zone settings.

1. Push **Menu**, **Programs**, and **VRI** to display the VRI screen. Refer to Figure 173-1.
2. Select the **Managed Zone** field and enter the Managed Zone using the numeric keypad.
3. Push the **Edit Managed Zone** button to display the Edit Managed Zone screen.
4. Select the **Left Angle** field and enter the Left Angle using the numeric keypad. Refer to Figure 173-2.
5. Select the **Right Angle** field and enter the Right Angle using the numeric keypad.
6. Select the **Inner Sprinkler** field and enter the Inner Sprinkler using the numeric keypad.
7. Select the **Outer Sprinkler** field and enter the Outer Sprinkler using the numeric keypad.
8. Select the **Duty Cycle** field and enter the Duty Cycle using the numeric keypad.
 - The Duty Cycle is entered in whole numbers between 0 and 100.
9. Push the **Save** button to save the Managed Zone values or push **Cancel** to return to the VRI-iS screen without saving the values.

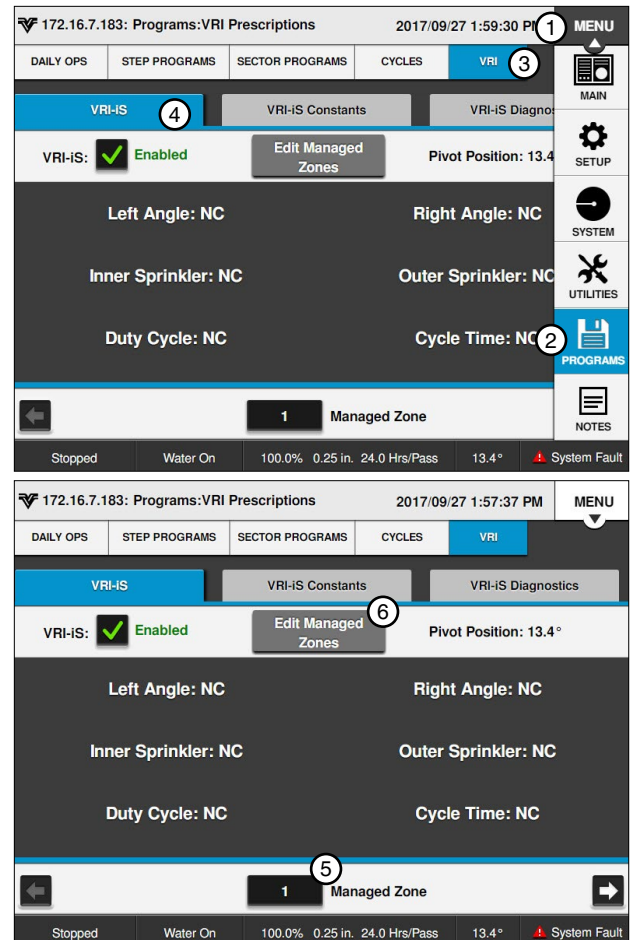

Figure 173-1 1. Menu
2. Programs
3. VRI
4. VRI-iS
5. Managed Zone
6. Edit Managed Zone

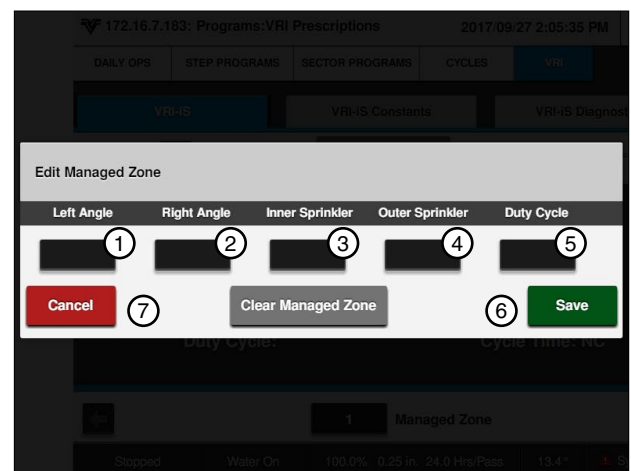

Figure 173-2 1. Left Angle
2. Right Angle
3. Inner Sprinkler
4. Outer Sprinkler
5. Duty Cycle
6. Save
7. Cancel

Programs / VRI-iS

VRI-iS Constants

Re-synchronize Valve Duty Cycle

When the valve re-synchronize pressure is reached, the duty cycles of all sprinklers. All odd numbered zones start on the off part of the cycle, and all even numbered sprinklers start on the on part of the cycle.

Valve Resync Pressure (PSI)

Valve Resync Pressure is used to monitor water pressure, and re-synchronizes the duty cycle of all sprinklers. When the valve re-synchronize pressure is reached, the duty cycles of all sprinklers start over.

1. Push **Menu, Programs, VRI, and VRI-iS Constants** to display the VRI-iS Constants screen. Refer to Figure 174-1.

The Valve Resync Pressure field displays the current resync pressure in psi (kPa).

2. To change the valve resync pressure, select the **Valve Resync Pressure** field.
3. Using the numeric keypad, enter a new resync pressure value. The range is 1-999 psi (6.90-6887.90 kPa). The default is 60 psi (413.7 kPa).

Minimum Cycle Time

The minimum cycle time function is used to view and change the sprinkler zone minimum valve cycle time.

1. Push **Menu, Programs, VRI and VRI-iS Constants** to display the VRI-iS Constants screen. Refer to Figure 174-1.
2. Select the **Min Cycle Time (seconds)** field, and enter the minimum cycle time value using the numeric keypad. The range is 1-255 seconds. The default is 20 seconds.

The minimum cycle time is displayed in seconds for the corresponding sprinkler bank number.

Maximum Cycle Time

The maximum cycle time function is used to view and change the sprinkler zone maximum valve cycle time.

1. Push **Menu, Programs, VRI and VRI-iS Constants** to display the VRI-iS Constants screen. Refer to Figure 174-1.
2. Select the **Max Cycle Time (seconds)** field, and enter the maximum cycle time value using the numeric keypad. The range is 20-9999 seconds. The default is 1800 seconds.

The maximum cycle time is displayed in seconds for the corresponding sprinkler bank number.

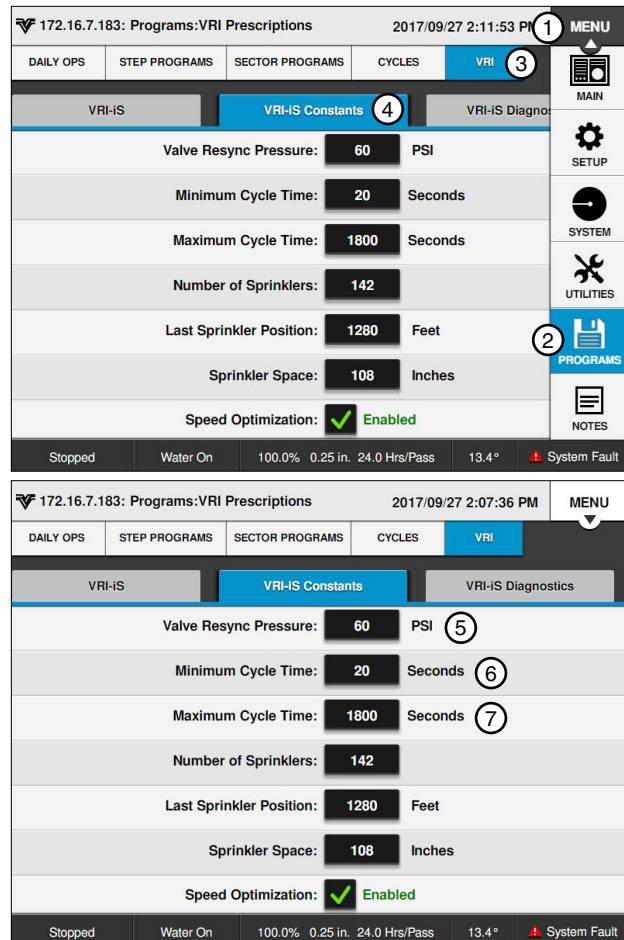

Figure 174-1 1. Menu
2. Programs
3. VRI
4. VRI-iS Constants
5. Valve Resync Pressure
6. Minimum Cycle Time
7. Maximum Cycle Time

VRI-iS Constants (Continued) Number of Sprinklers

The Number of Sprinklers constant is used to set the number of sprinkler valves. This is required so that the control panel knows how many sprinkler valves it must communicate with during configuration of the valve network.

1. Push **Menu, Programs, VRI** and **VRI-iS Constants** to display the VRI-iS Constants screen. Refer to Figure 175-1.
2. Select the **Number of Sprinklers** field, and enter the number of sprinklers using the numeric keypad.

Last Sprinkler Position

The Last Sprinkler Position constant is the distance from the pivot point to the last sprinkler valve in feet or meters.

1. Push **Menu, Programs, VRI** and **VRI-iS Constants** to display the VRI-iS Constants screen. Refer to Figure 175-1.
2. Select the **Last Sprinkler Position** field, and enter the number of sprinklers using the numeric keypad.

Sprinkler Spacing

The Sprinkler Spacing constant is used to set the distance between sprinkler valves in inches or millimeters. If the spacing varies, enter the spacing used for valve that is furthest away from the pivot point.

1. Push **Menu, Programs, VRI** and **VRI-iS Constants** to display the VRI-iS Constants screen. Refer to Figure 175-1.
2. Select the **Sprinkler Spacing** field, and enter the space between sprinkler valves using the numeric keypad.

Speed Optimization Enable/Disable

The Speed Optimization feature speeds up the machine if, in a given sector, all the duty cycles are less than 100%.

Enable or Disable Speed Optimization by following these steps:

1. Push **Menu, Programs, VRI** and **VRI-iS Constants** to display the VRI-iS Constants screen. Refer to Figure 175-1.
2. Check the **Speed Optimization** checkbox to enable Speed Optimization.
 - Uncheck the Speed Optimization checkbox to disable Speed Optimization.

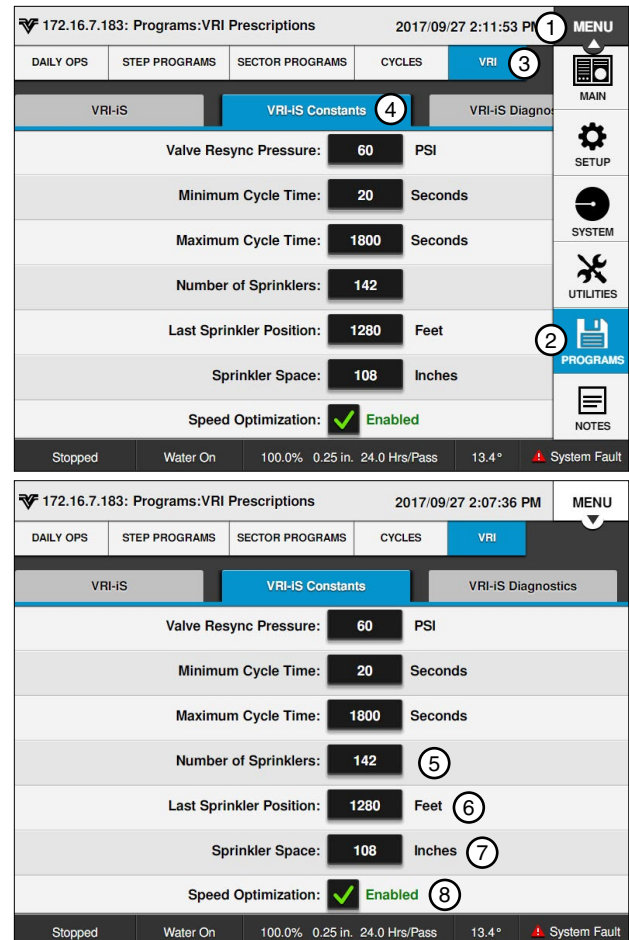

Figure 175-1 1. Menu 5. Number of Sprinklers
2. Programs 6. Last Sprinkler Position
3. VRI 7. Sprinkler Space
4. VRI-iS Constants 8. Speed Optimization

Programs / VRI-iS

VRI-iS Diagnostics

Configure Network

The Configure Network function is used to configure the communication network between the control panel and each valve.

1. Push **Menu**, **Programs**, **VRI**, and **VRI-iS Diagnostics** to display the VRI-iS diagnostics screen. Refer to Figure 176-1.
2. Push the **Configure Network** button to display the Configure VRI-iS Network screen.
3. When prompted to initiate VRI-iS network configuration, push the **Yes** button.
4. When configuration is complete the VRI-iS Network Configuration Complete screen will be displayed.

Push the **Cancel** button to return to the diagnostics screen or push the **Reconfig Network** button to run the network configuration again.

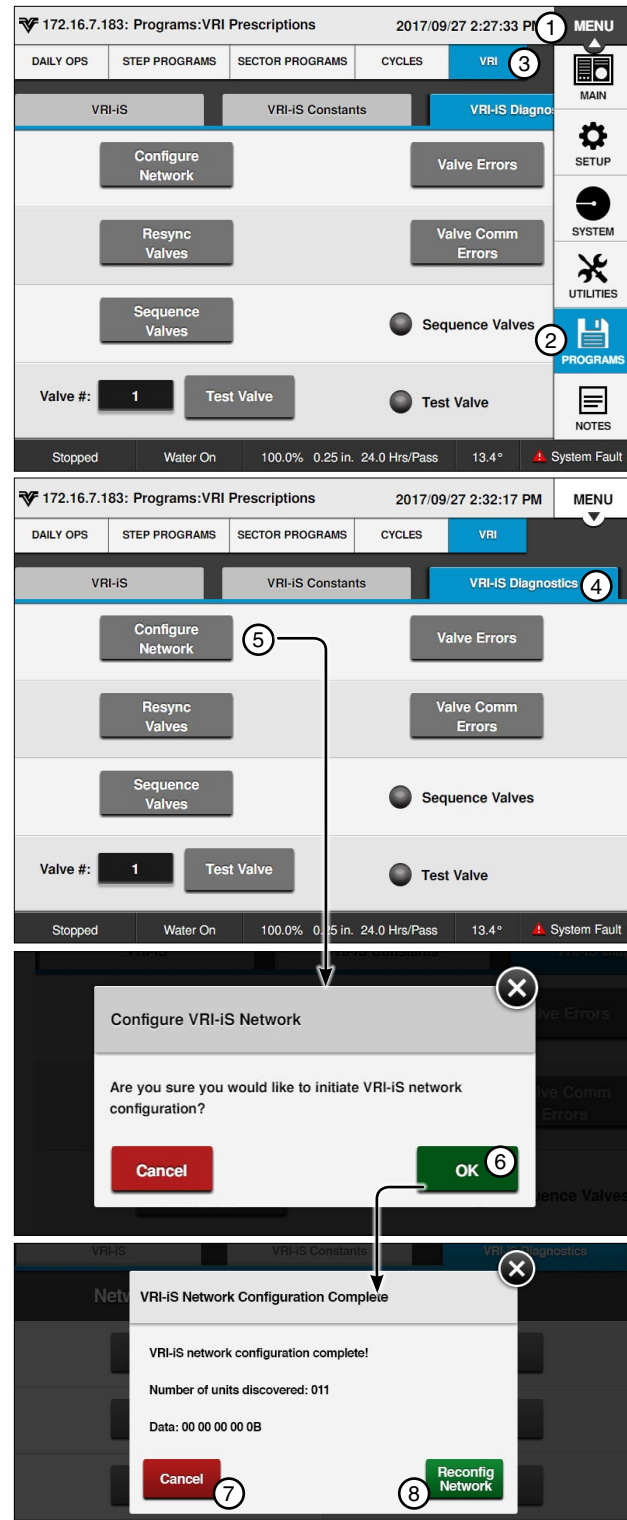

Figure 176-1 1. Menu 5. Configure Network
2. Programs 6. Yes
3. VRI 7. Cancel
4. VRI-iS Diagnostics 8. Reconfig Network

VRI-iS Diagnostics (Continued)

Resync Valves

Use Resync Valves to manually re-synchronize the duty cycle of all sprinkler banks.

NOTE

- The VRI-iS protocol must be enabled via RJ11 on the Comm Port screen.

The duty cycles of all valves will start over. Valves will be staggered evenly within their managed zone.

1. Push **Menu**, **Programs**, **VRI**, and **VRI-iS Diagnostics** to display the VRI-iS diagnostics screen. Refer to Figure 177-1.
2. Push the **Resync Valves** button to re-synchronize.
3. When prompted to initiate a valve resync, push the **OK** button.

Sequence Valves

Use Sequence Valves to test valve operation. The feature will turn all valves on and then turn each valve off for 5 seconds, in sequence, beginning with valve 1 and ending with the last valve.

1. Push **Menu**, **Programs**, **VRI**, and **VRI-iS Diagnostics** to display the VRI-iS diagnostics screen. Refer to Figure 177-1.
2. Push the **Sequence Valves** button to test valve operation.
3. When prompted to initiate valve sequencing, push the **OK** button.

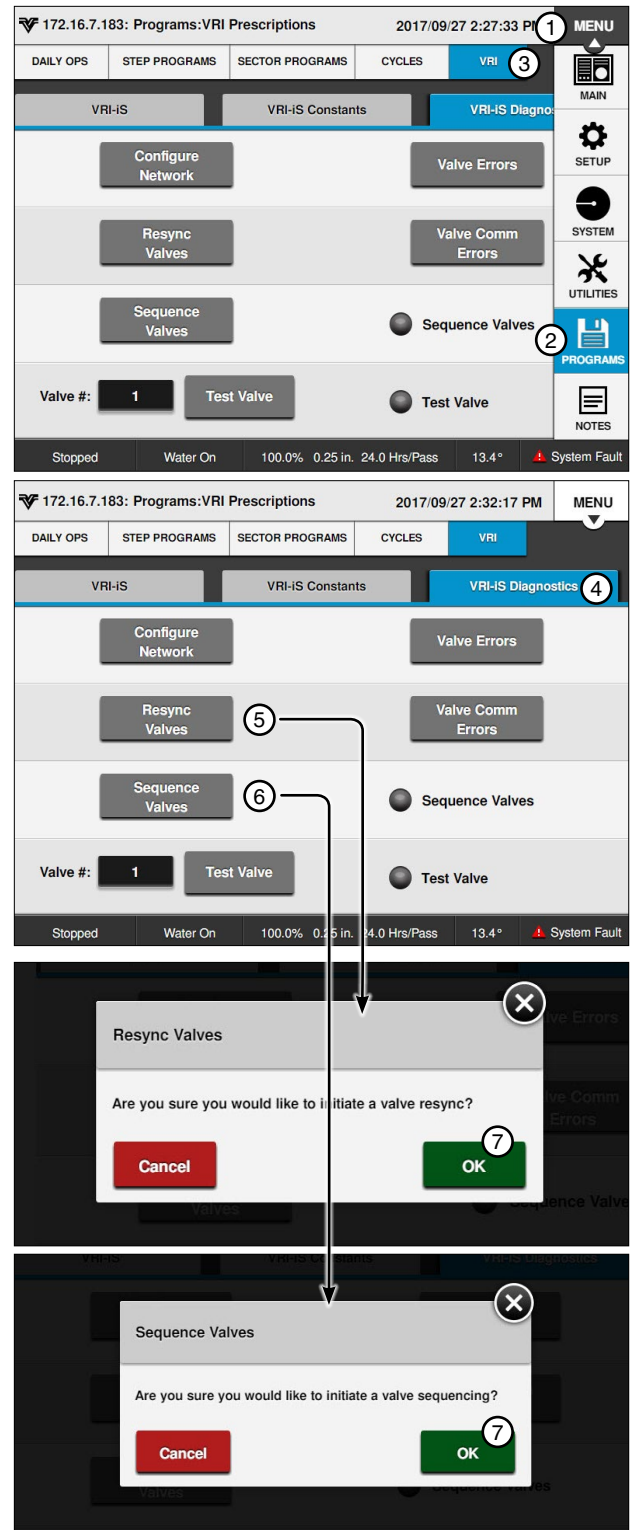

Figure 177-1 1. Menu
2. Programs
3. VRI
4. VRI-iS Diagnostics
5. Resync Valves
6. Sequence Valves
7. OK

Programs / VRI-iS

VRI-iS Diagnostics (Continued)

Test Valve

This diagnostic is used to test sprinkler zones for proper operation. This feature turns all sprinkler banks on. Then, it turns the sprinkler bank number entered off.

This setting is maintained for five minutes or until a different sprinkler bank is commanded off. After five minutes the control panel resorts back to the programmed settings.

NOTE

- System should be running with water on to test valve operation.

1. Push **Menu**, **Programs**, **VRI**, and **VRI-iS Diagnostics** to display the VRI-iS diagnostics screen. Refer to Figure 178-1.
2. Select the **Valve #** field and set the valve number using the numeric keypad.
3. Push the **Test Valve** button to display the Test Valve screen.
4. When prompted to turn the valve off for 5 minutes push the **OK** button. While the valve test is running the Test Valve is Running Indicator will turn on.

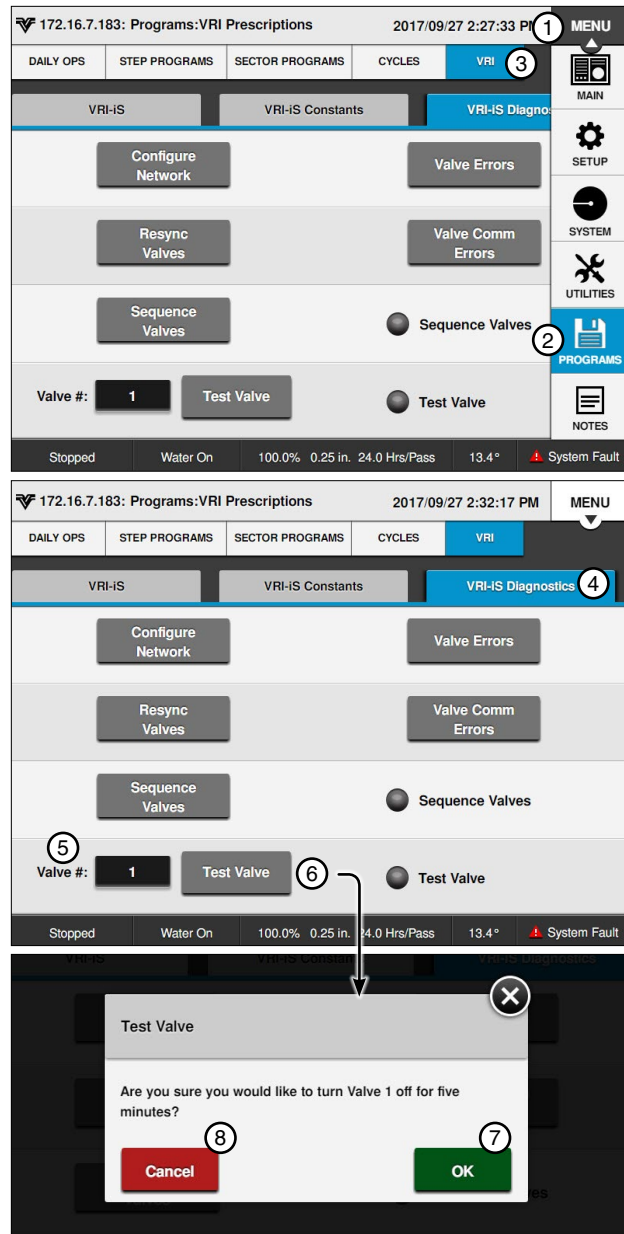

Figure 178-1 1. Menu 5. Valve#
2. Programs 6. Test Valve
3. VRI 7. OK
4. VRI-iS Diagnostics 8. Cancel

VRI-iS Diagnostics (Continued)

Valve Errors

Use Valve Errors to view on errors, off errors, and low power errors for all sprinkler valves. On errors and off errors only occur if the optional pressure switch is installed on the valve assembly.

1. Push **Menu**, **Programs**, **VRI** and **VRI-iS Diagnostics** to display the VRI-iS diagnostics screen. Refer to Figure 179-1.
2. Push the **Valve Errors** button to display the Valve Errors screen.
3. Use the **Next** and **Previous** buttons to view the desired sprinkler valve number.

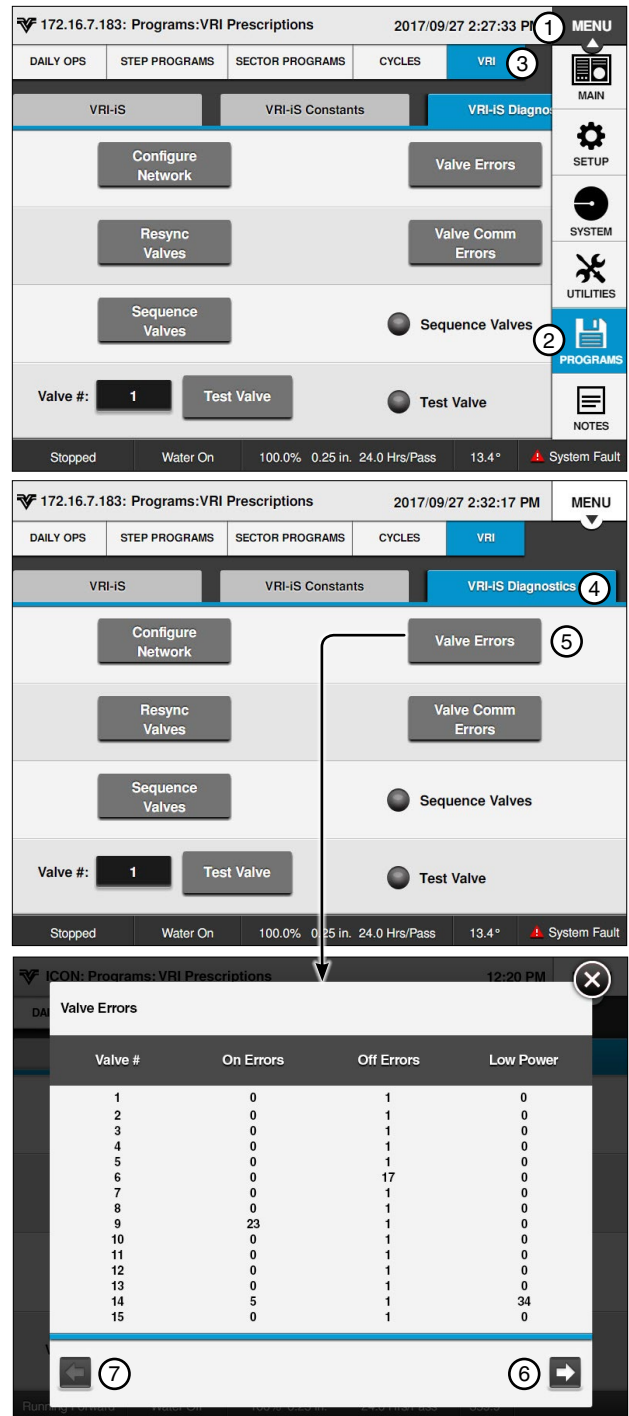

Figure 179-1 1. Menu
 2. Programs
 3. VRI
 4. VRI-iS Diagnostics
 5. Valve Errors
 6. Next
 7. Previous

Programs / VRI-iS

VRI-iS Diagnostics (Continued)

Valve Comm Errors

Use Valve Comm Errors to view communication errors for all sprinkler valves.

1. Push **Menu**, **Programs**, **VRI** and **VRI-iS Diagnostics** to display the VRI-iS diagnostics screen. Refer to Figure 180-1.
2. Push the **Valve Comm Errors** button to display the Valve Comm Errors screen.
3. Use the **Next** and **Previous** buttons to view the desired sprinkler valve number.

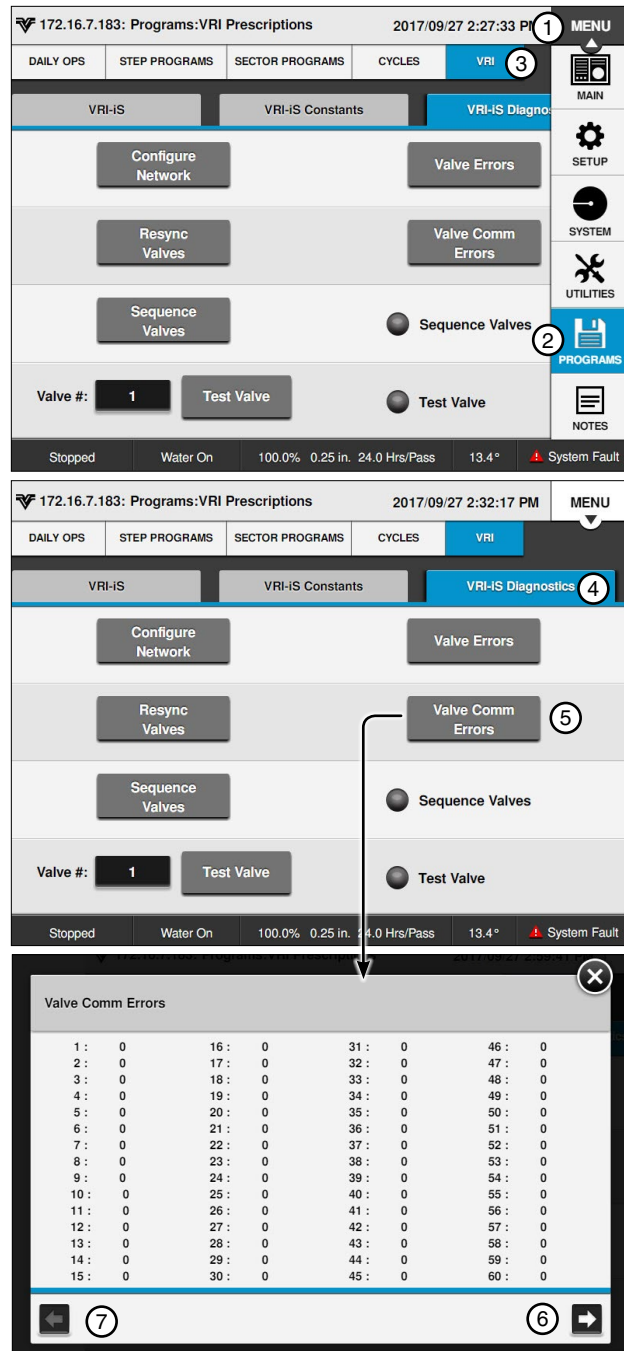

Figure 180-1 1. Menu
2. Programs
3. VRI
4. VRI-iS Diagnostics
5. Valve Comm Errors
6. Next
7. Previous

Design Forms

This appendix provides blank forms for your use when planning your Step and Sector programs. They provide you with the ability to describe the conditions, commands, and options you want included in the programs.

Make as many copies of these forms as you need. You may want to keep the completed design forms on file for future reference.

Step Programming Design Form

Use the circular drawing to map out the field, and the table to describe the conditions, commands, and options required in each step of the program. You can have up to 17 Step programs for each machine, with up to 9 steps in each.

NOTE

- The commands in each step will be executed in the order in which they are entered..

Sector Programming Design Form

Use the circular drawing to map out the field, and the table to describe the commands and options required in each sector of the field. You can have up to 20 Sector programs for each machine, with up to 9 steps in each.

NOTE

- The commands for each sector will be executed in the order in which they are entered.

Programming Design Forms

STEP Program Number _____
 Field ID _____

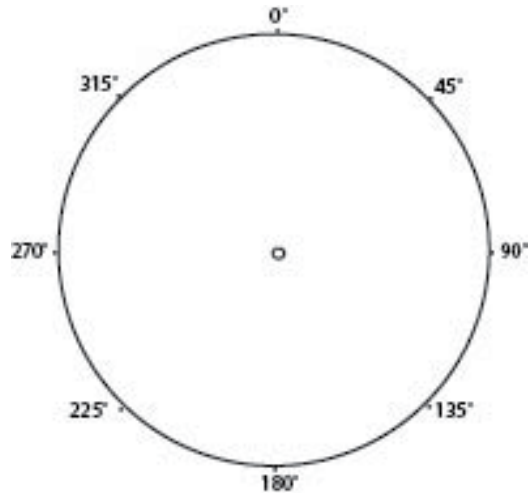

CONDITIONS	STEP 1	STEP 2	STEP 3	STEP 4	STEP 5	STEP 6	STEP 7	STEP 8	STEP 9
DATE / TIME									
DAY / TIME									
POSITION									
PRESSURE									
DELAY									
DIRECTION									
ANALOG									
MODULE									
PULSE RATE									
PULSE COUNT									
RAIN									
WIND									
FLOW									
TEMPERATURE									
DISPLAY IGNITION									
END GUN									
AUXILIARY									
REMOTE START									
PRESSURE SWITCH									
SPARE PTG									
SAFETY SENSE									
CABLE THEFT									
COMMANDS									
START/STOP									
DIRECTION FOR/REV									
WATER ON/OFF									
DEPTH									
PERCENTAGE									
AUX 1 ON / OFF									
AUX 2 ON / OFF									
STOP-IN-SLOT ON/OFF									
RUN PROGRAM									
ARAS									
AUTO RESTART									
SET CYCLE									
% OF % ADJUST % TIMER									
% OF DEPTH, ADJUST DEPTH BY A %									
LOG EVENT									
VRI ON/OFF									
CRUISE CONTROL ON/OFF									
12 V POWER									
END-GUN 1, 2, 3, 4									

Programming Design Forms

SECTOR Programs
Field ID _____

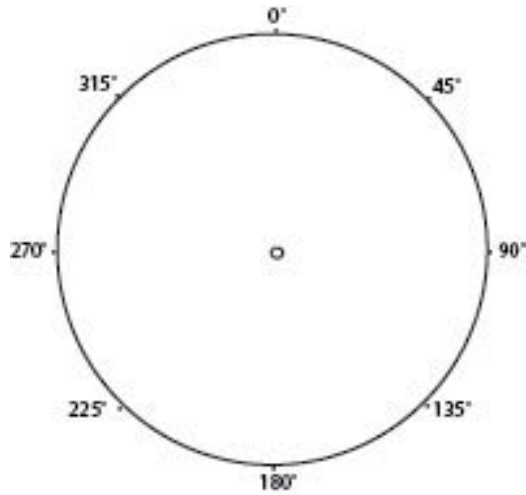

Sector Program #	Start Angle	End Angle	Direction	Commands
1				
2				
3				
4				
5				
6				
7				
8				
9				
10				
11				
12				
13				
14				
15				
16				
17				
18				
19				
20				

Programming Design Forms
