



**ICON5 / ICONX
Control Panel
Owner's Manual**

0999938_C

**Software Versions:
ICON5 v 1.01
Smart Relay Board (SRB) v 1.01**

This page was left blank internationally.

Table of Contents

Quick Reference Guide	5	Control Panel Setup	
EC Declaration of Conformity	7	Display Setup	31
Electrical Safety Statement	8	Language and Units of Measure	31
About This Manual	8	Date / Time	33
Ancillary Equipment Warranty	8	Main Screen Setup	34
Safety		Field.....	34
Recognize Safety Information	9	Statuses	35
Safety Messages	9	Controls	36
Information Messages	9	Minimum Control Panel Setup	37
Use of Personal Protective Equipment	10	Set Up Position Encoder	40
Conductive Materials and Equipment	10	Set Up GPS Position	42
Fall Protection	10	Set Up Position Loss	47
Minimum Working Clearance	11	System Shutdown.....	47
Qualified Person.....	11	Disable Endguns.....	47
Overhead Power Lines.....	12	Runtime Fallback Position.....	47
Minimal Lockout / Tagout Procedure	13	Test GPS Position.....	48
Sequence of Lockout.....	13	Voltage	49
Restoring Equipment to Service.....	13	Low Voltage.....	49
Operate Safely	14	Estimated Drive Unit Speed Tables.....	50
Safety Decals.....	18	GPS Angular Conversion Table.....	51
Overview		Angular Degree Examples	51
ICON5 Control Panel	22	Constants Record	52
Main Disconnect	22	Before Running the Machine	56
Safety Override Switch	22	Run The Machine Wet (With Water).....	56
3-Second Delay Timer	22	Run The Machine Dry (Without Water)	56
Pump Restart Delay.....	22	Operation	
ICONX Control Panel	23	Stopping The Machine	57
Main Disconnect	23	Emergency Stopping	57
Safety Override Switch	23	Stopping Under Normal Conditions.....	58
3-Second Delay Timer	23	Diagnostics	
Pump Restart Delay.....	23	System Stops and Faults	59
Main Screen.....	24	Clearing Faults	59
Control Buttons.....	25	System Stop Descriptions	60
Status	26	System Fault Descriptions.....	61
Menu	27	Error Codes.....	62
Keypad	28	System Errors.....	62
Pivot Circle Colors and Shapes.....	29	Error Notification	62
Other Buttons and Functions.....	30	Viewing Error Codes.....	62
		Resetting Error Count	62
		System Error Codes and Descriptions.....	63
		Comm Board	64
		Viewing Error Codes.....	64
		Clearing Error Codes	64
		Comm Board Component IDs / Error Messages ..	65
		Valley GPS Errors	66
		Viewing Error Codes.....	66
		Clearing Error Codes	66
		Valley GPS Error IDs and Descriptions	67

Table of Contents

History

Viewing Standard History	68
Viewing Advanced History	69
History Screen Events	70
Cruise Log.....	71

Troubleshooting

System Stops and Faults	72
System Error Codes.....	75
Troubleshooting List.....	80
ICON5 Software	
Update ICON5 Software.....	82
Smart Relay Board	
SRB Default Reset	84
Update SRB Firmware	85
Backup Panel Settings	87
Restore Panel Settings.....	89



Navigation

Menu Button.....	91
Setup Button	92
System Button.....	93
Utilities Button	94
Programs Button	95



To Run The Machine: (Refer to the Overview and Operation sections of the Owner's Manual, and to the Advanced Features Manual.)

- ALWAYS make sure that vehicles, other equipment, livestock, and people are clear of the machine before operating.
- Turn the control panel main disconnect switch to the on position. If the power is supplied by an engine driven generator, set generator to proper voltage/Hz. Do not exceed system specifications.

Run The Machine Wet (With Water)

1. Push the **Water** button on the Main Screen to turn the water on.
2. To set the water application, select either the **Depth** field or **Wet % Timer** field.
 - In the Depth field, set the water application depth by inches or millimeters.
 - or
 - In the Wet % Timer field, adjust the percent to obtain the desired water application depth.
 - a) Enter either the depth or percent timer setting.
 - b) Push **ENTER** to retain the value.
3. Do one of the following:
 - Push  button to start the machine in the forward direction.
 - Push  button to start the machine in the reverse direction.
 - Push  to stop the machine.

Run The Machine Dry (Without Water)

1. Push the **Water** button on the Main Screen to turn the water off.
2. To set the speed of travel, select the **Dry % Timer** field.
 - In the Dry % Timer field, adjust the percent to obtain the desired speed of travel.
 - a) Enter the percent timer setting.
 - b) Push **ENTER** to retain the value.
3. Do one of the following:
 - Push  button to start the machine in the forward direction.
 - Push  button to start the machine in the reverse direction.
 - Push  to stop the machine.



If a control is not configured to be shown on the Main Screen, push Menu and Controls to view it on the Controls Screen.

Controlling Auxiliary Relays:

1. Push **Menu** and **Controls**.
2. Push the **Aux1** or **Aux2** button to turn on or off.

Turning Stop-In-Slot On/Off:

1. Push the **SIS (Stop In Slot)** button to turn on or off.
 - Turn SIS on to stop at the stop-in-slot location.
 - Turn SIS off to bypass the stop-in-slot location.

To Set the Stop-In-Slot Position:

1. Select the **SIS (Stop In Slot)** field.
2. Enter the desired stop-in-slot position in degrees and push **ENTER**.

Turning Power and Pressure Restart On:

1. Push **Menu** and **Controls**.
2. Push the **Auto Restart** button to turn on or off.

Refer to "Auto Restart Via:" in the Advanced Features Manual for more information.

Selecting Auto Reverse or Auto Stop:

1. Push **Menu** and **Controls**.
2. Push the **Auto Reverse Auto Stop** button to toggle between Auto Reverse on or Auto Stop on.

AR/AS must be Enabled. Only applicable with the drive-unit-mounted auto reverse hardware. Refer to "Auto Reverse Auto Stop (AR/AS)" in the Advanced Features Manual more information.

Setting The End Gun:

Refer to Figure 5-1 below.

1. Push **Menu** and **End Guns**.
2. Check the EG (end gun) checkbox to enable it.
3. Push the **Configure** button for the end gun.
4. Select the **Left** field (end gun on angle) for a sequence Pair, and enter the degrees on the numeric keypad. Push **ENTER**.
5. Select the **Right** field (end gun off angle) for a sequence Pair, and enter the degrees on the numeric keypad. Push **ENTER** to confirm setting, push RETURN for previous screen.
6. Repeat steps 4 and 5 for other sequence pairs as needed. Use the arrows at the bottom of the screen to view other sequence pairs.

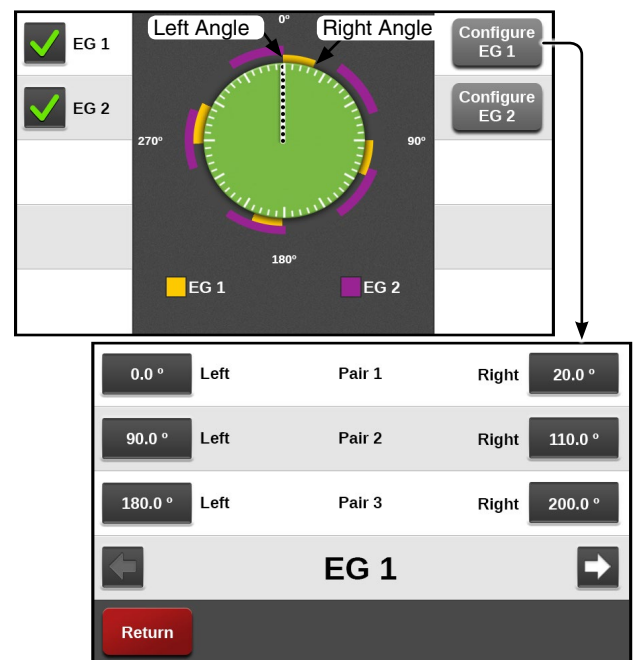

Figure 5-1

Quick Reference Guide

System Stops and Faults

System Stop	Threshold
Command	The machine was intentionally commanded to stop by pushing the Stop button.
Stop-In-Slot (SIS)	The current machine position matches the Stop-In-Slot position while the machine was waiting/running.
Daily Ops	With the Daily Ops Control enabled and Daily Ops Mode selected, the system was started outside of the start/stop range of Daily Ops.
Program	A stop command in a step or sector program shut down the machine.
Auto-Stop	The Auto Stop boundary was reached and shut down the machine.
System Fault	Threshold
System Power Lost	Voltage dropped below half the low voltage limit for 3 seconds or more while the machine was waiting/running with water on or more than 1 second if running with water off.
System Power Low	Voltage fell below the low voltage limit for 15 seconds or more while the machine was waiting/running.
System Safety	Safety circuit was de-energized for more than 3 seconds.
Low Pressure	Water pressure fell below the Low Pressure Limit for more than the Operating Pressure Delay time while the machine was running with water on and after the Startup Pressure Delay has expired.
High Pressure	Water pressure remained above the High Pressure Limit for at least the High Pressure Shutdown Delay time.
NVMEM	E01 error is active, Memory Error, Backup Battery failure.
Forward/Reverse	Both the forward and reverse circuits were on for more than 15 seconds while the machine was waiting/running.
Operating Sector	With AR/AS and For/Rev Position both enabled, the machine is waiting/running or was started outside of the Forward or Reverse Position angles.
Wind	With Wind Shutdown enabled, the Wind Speed went above the Wind Speed Limit for more than 1 minute while the machine is running with water on.
Temperature	With the Temperature Shutdown enabled, the Current Temperature goes below the Low Temperature Limit while water is on.
Rain	With the Rain Shutdown enabled, the Total Rainfall for the Rain Window goes above the Rain Shutdown Limit while water is on.
Flow	While the machine is running with water on, the Flow Rate falls below the Low Flow Limit after adequate water pressure has been achieved.
Water Timer	With the Water Timer enabled, the time accumulated by the Overwater Timer is greater than the Overwater Shutdown time.
Tire Pressure	With Shutdown Pressure Control enabled, the Reported Tire Pressure of a tire is below the Nominal Tire Pressure for that tire's tower by at least the Shutdown Pressure Drop for two consecutive sensor readings.
GPS Com	With GPS Position and Shutdown On Position Loss enabled, while the machine is waiting/running there has been no GPS communications and the Shutdown On Position Loss Delay time has expired.
GPS Lock	With GPS Position and Shutdown On Position Loss enabled, while the machine is waiting/running the GPS Lock Status is None and the Shutdown On Position Loss Delay time has expired.
Cut Cable	A cut cable was Detected when the machine was started.
PCB Hardware	PCB hardware issue detected while the machine is waiting/running.
12V Power	With Backup Battery enabled, the battery backup supply voltage fell below 10 volts or the unit has been powered from the battery backup supply and the Battery Backup Time has expired.
Position Encoder Com	With the Position Encoder option and Shutdown On Position Loss enabled, and while the machine is waiting/running the position encoder has not been communicating and the Shutdown On Position Loss Delay time has expired.
License	The protocol license is not valid.

Error Codes

Error	Description	Error	Description
E01	NVMEM Corrupted	E16	VDC Communication Error- Primary COM Module
E02	PCB Hardware Issue	E17	VRI-iS Sprinkler Communication Error
E03	Software Reset	E18	GPS Communications Error
E04	Power Dropped Below Low Voltage Limit	E19	GPS Signal Loss
E05	System Safety Lost	E20	DGPS Signal Loss
E06	Pressure Too Low After Pressure Delay	E21	Flow Rate Below Low Flow Limit
E07	Pressure (mV) sensor out of range high	E22	Pressure Above High Pressure Limit
E08	Pressure (mV) Sensor Out of Range Low	E23	PLC Communications Error
E09	Pressure (mA) Sensor Out of Range High	E24	Valve Duty Cycles Re-Synced Due to High Pressure
E10	Pressure (mA) Sensor Out of Range Low	E25	GPS Coordinates Out of Range
E11	Pressure Switch Active With Pump Off	E26	Low Tire Pressure
E12	Valley GPS Pressure Sensor Out of Range High	E27	TPMS Communications Error
E13	Valley GPS Pressure Sensor Out of Range Low	E28	VDC Error Report Message Received
E14	FWD/REV Sense Shorted	E29	Valley GPS Communication Error, Master OPMC
E15	Underwater Error	E30	Valley GPS Error Report Message Received

EC Declaration of Conformity



We: **Valmont Industries, Inc.**
28800 Ida Street
Valley, NE 68064
+1 402.359.6312
+1 402.359.6143 (Facsimile)

Serial Number:

declare under our sole responsibility that the product,

Crop Irrigation System

Purchase Order:

to which this documentation relates, is in conformity with the following documents:

Machinery Directive 2006/42/EC
Low Voltage Directive 2014/35/EU
Electromagnetic Compatibility Directive 2014/30/EU

The above-referenced equipment is in conformity with all safety-related clauses (Not all clauses reflecting commercial preference are met) of the following documents:

EN 60204-1:2006 Safety of Machinery – Electrical Equipment of Machines
EN 12100:2010 Safety of Machinery
EN 909:1998+A1 Irrigation Machines

Statement regarding **Pressure Equipment Directive 97/23/EC:**

The Crop Irrigation System is excluded from the scope of the Pressure Equipment Directive, by the language of Article 1, Sections 3.2, 3.6 & 3.10. This equipment is classified less than Category 1.

Statement regarding **RoHS Directive 2011/65/EC:**

The Crop Irrigation System is excluded from the scope of the RoHS Directive, by the language of Article 2, Section 4(e), being a "Large Scale Fixed Installation."

Person Authorized to Compile the Technical File in Europe:
Relevant information will be transmitted via email
in response to a reasoned request by national authorities

Philipp Schmidt-Holzmann
Valmont S.A.U.
28840 Mejorada del Campo
Madrid, ES 28840
+34 91 679 4300

Ron Pollak
Senior Electrical Engineer
Valmont Industries, Inc.

Date of Issue: March 9, 2018
Place of Issue: Valley, NE 68064

Electrical Safety Statement

Installation of the Valley Electric Irrigation Machine - European Union Only

Valmont Industries Inc. does not install a differential (ground fault) circuit breaker in the control panel of the Valley electric irrigation machine because the standards of protection vary according to country of destination. The distributor must provide and install a differential (ground fault) circuit breaker that meets the standards of the country where the Valley irrigation machine is installed.

In the European Union, differential circuit breaker protection is fixed at a maximum of 24 VAC.

Good grounding of the Valley irrigation machine is required.

- If resistance to ground is lower than 80 ohms, a differential (ground fault) circuit breaker of 300 mA will meet requirements.
- If resistance to ground is between 80 and 800 ohms, a differential (ground fault) circuit breaker of 30 mA will meet requirements.

The power supply installation and inspection of equipment protection components or machines are the responsibility of the installer. Valmont Industries Inc. is not responsible for the failure of equipment protection components or machines not of their manufacture.

Valley pivot irrigation machines receiving power from a generator must have a cable connected from the irrigation machine structure to a ground rod and another cable from the irrigation machine structure to the ground terminal on generator in order for the differential (ground fault) circuit breaker to work.

- The resistance between the irrigation machine and the generator must be substantially below 80 ohms.

About This Manual

Information contained in this manual applies to Valley ICON5 and ICONX Control Panels with Software Versions ICON5 v 1.01 and Smart Relay Board (SRB) v 1.01. Sections related to safety, pivot hardware, maintenance, towing, troubleshooting and winterization are covered in the appropriate Valley Pivot Owners Manual.

You, as the owner/operator, should familiarize yourself with the capabilities of the system in order to obtain optimum system performance. It should be remembered that the sprinkler will perform according to your knowledge of the equipment, soil and water relationships and equipment application concepts.

Specifications, descriptions and illustrative material contained herein were as accurate as known at the time this publication was approved for printing. Valmont Industries Inc. reserves the right to change specification or design without incurring obligation. Specifications are applicable to machines sold in the United States and may vary outside the United States.

Additional information is contained within the Advanced Features Manual part number 0999984 (English) for this control panel.

Ancillary Equipment Warranty

The owner is responsible for warranty registration of all ancillary equipment such as engines, pumps and generators with its respective manufacturer.

Recognize Safety Information

This irrigation equipment can be powered by high voltage, which can be extremely dangerous if used improperly. For maximum safety and optimum performance of the machine, all owner/operators and maintenance personnel must read and understand the owner/operator manual(s), all safety messages in this manual and safety signs/decals on the machine before operating this equipment.

Anyone assembling, operating, servicing or maintaining this machine must read and understand all operation, maintenance, troubleshooting, testing, installation, assembly instructions and all safety messages in this manual before operating the machine or beginning any maintenance, troubleshooting, testing, installation or assembly of components.

These instructions alert you to certain things you should do carefully; if you don't, you could hurt yourself or others, hurt the next person who operates the equipment, or damage the equipment.

Safety Messages

Safety messages in this manual are preceded by the hazard symbol and one of three words: DANGER, WARNING or CAUTION. These messages alert you to potential hazards that could hurt you or others and or cause property damage.



This HAZARD SYMBOL is used to alert you to information about unsafe actions or situations, and may be followed by the word DANGER, WARNING or CAUTION.

DANGER

The HAZARD SYMBOL used with the word DANGER describes immediate hazards that can result in severe personal injury or death.

WARNING

The HAZARD SYMBOL used with the word WARNING describes unsafe actions or situations that can result in severe injury, death and/or major equipment or property damage.

CAUTION

The HAZARD SYMBOL used with the word CAUTION describes unsafe actions or situations that can result in injury, and/or minor equipment or property damage.

Information Messages

Important information messages in this manual are preceded by the word NOTE.

NOTE

The word NOTE is used to alert you to information that describes procedures or tips to help you install, operate or maintain your equipment properly.

Safety

Use of Personal Protective Equipment

- People working in areas where there are potential electrical hazards must use, personal protective equipment that is appropriate for the specific parts of the body to be protected and for the work to be performed. Refer to U.S. Occupational Safety & Health Administration (OSHA) Regulations (Standards - 29 CFR) Safeguards for personnel protection. - 1910.335, or applicable national, state or local regulations, for additional information.
- Personal protective equipment must be maintained in a safe, reliable condition and periodically inspected or tested.
- Protective shields, protective barriers, or insulating materials must be used to protect each person from shock, burns, or other electrically-related injuries while that person is working near exposed energized parts which might be accidentally contacted or where dangerous electric heating or arcing might occur. When normally enclosed live parts are exposed for maintenance or repair, they must be guarded to protect unqualified persons from contact with the live parts.
- Safety signs and tags, safety signs, safety symbols, or accident prevention tags must be used where necessary to warn people about electrical hazards which may endanger them.

Conductive Materials and Equipment

Materials and equipment that can conduct electricity must be handled in a way that will prevent them from contacting energized power lines, exposed conductors or circuit parts.

- When handling long conductive objects (such as but not limited to truss rods, pipes, angles and ladders) in areas with energized power lines, exposed conductors or circuit parts, work practices (such as the use of insulation, guarding, and material handling techniques) must be used to minimize the hazard.
- Portable ladders must have non-conductive side rails.
- Do not wear conductive articles of jewelry and clothing (such as but not limited to watch bands, bracelets, rings, key chains, necklaces, metalized aprons, cloth with conductive thread, or metal headgear) that could come in contact with energized power lines, exposed conductors or circuit parts.

Fall Protection

Identify potential fall hazards and determine if fall protection equipment is appropriate for the task, before beginning the work. Pay attention to hazards associated with routine and non-routine tasks. Inspect fall protection equipment (harnesses, lanyards) and devices (guardrails, tie-off points) before each use. Use fall protection equipment if required for the job. Be sure the fall protection equipment is right for the task, fits properly, and is in good condition. Refer to U.S. Occupational Safety & Health Administration (OSHA) Regulations Standards - 29 CFR 1926.500, 1926.501 and 1926.502, or applicable national, state or local regulations for more information.

- When using scaffolds, make sure there is proper access, full planking, stable footing, and guard railing.
- When using a boom lift, keep feet firmly on the platform of a boom lift, use fall protection equipment tied-off at all times to the guardrail or tie-off point.
- When using a ladder, make sure the ladder is non-conductive and the correct size for the task. Read the ladder user instructions and be sure the ladder is in good condition. Make sure ladder is set on stable footing and at the correct angle.

Minimum Working Clearance

To reduce the risk of injury, all persons require adequate working clearance around the electrical panel or other electrical equipment. The table below identifies the minimum working clearance needed. Refer to U.S. Occupational Safety & Health Administration (OSHA) Regulations (Standards - 29 CFR) Safeguards for personnel protection -1910.303(g)(1)(i), or any other applicable national, state or local regulations, for additional information.

MINIMUM WORKING CLEARANCE 0-600 VOLTS				
WIDTH OF WORKING CLEARANCE AREA	HEIGHT OF WORKING CLEARANCE AREA	★MINIMUM WORKING CLEARANCE IN FRONT OF ELECTRICAL PANEL/EQUIPMENT		
		EXPOSED LIVE PARTS ON ONE SIDE OF WORK SPACE AND NO LIVE GROUNDED PARTS ON THE OTHER SIDE.	EXPOSED LIVE PARTS ON ONE SIDE OF WORK SPACE AND LIVE GROUNDED PARTS ON THE OTHER SIDE.	EXPOSED LIVE PARTS ON ONE SIDE OF WORK SPACE AND EXPOSED LIVE PARTS ON THE OTHER SIDE.
30 in (760 mm) MINIMUM OR WIDTH OF ENCLOSURE, WHICH EVER IS GREATER	78 in (1980 mm) MINIMUM OR HEIGHT OF ENCLOSURE, WHICH EVER IS GREATER	36 in (915 mm) MINIMUM	42 in (1065 mm) MINIMUM	48 in (1220 mm) MINIMUM

★Concrete, brick or tile walls shall be considered as grounded.

Qualified Person

A Qualified Person is one who, by possession of a recognized degree, certificate, or professional standing, or who by extensive knowledge, training, and experience, has successfully demonstrated his/her ability to solve or resolve problems related to the subject matter, the work, or the project.

Only qualified persons may work on electric circuit parts or equipment that have not been de-energized.

Refer to U.S. Occupational Safety & Health Administration (OSHA) Regulations Standards - 29 CFR 1926.32(m) and 1910.333, or applicable national, state or local regulations for additional information.

Safety

Overhead Power Lines

Assembling, towing or transporting irrigation machine components such as but not limited to the pivot point, linear cart, span/drive unit assemblies, overhangs and/or corner assemblies underneath or near power lines is extremely dangerous because of the risk of electrocution.

Operating equipment that elevates irrigation machine components, such as but not limited to an aerial lift or crane, near power lines is extremely dangerous because of the risk of electrocution. Only qualified personnel should operate this type of equipment. Before operating the equipment, qualified personnel must read the equipment manufacturers' operating and safety instructions.

Refer to U.S. Occupational Safety & Health Administration (OSHA) Regulations (Standards - 29 CFR) Cranes and derricks. - 1926.550, or any other applicable national, state or local regulations for additional information.

- Always presume that any overhead power line is an energized line unless and until the person(s) owning the line and/or the electrical utility authorities indicate that it is not an energized line and it has been visibly grounded.
- Before operating any equipment near any power line make sure the line has been de-energized and visibly grounded at the point of work.
- Electrocution can occur without touching an electrical power line. Electricity, depending on the magnitude, can jump or become induced into equipment or conductive materials that come in close proximity to, but do not touch a power line. High wind, lightning, wet ground and other environmental conditions will increase the possibility of electrocution and require additional consideration.
- Transmitter towers can induce the equipment or materials being handled with an electrical charge. Before working or operating equipment near transmitter towers, make sure the transmitter is de-energized.
- Select the location where the span/drive unit will be assembled to ensure that neither the irrigation machine, or the equipment used during the assembly process, will violate the minimum clearance guidelines.
- Never operate equipment or allow the load, ropes or tag lines within 10 ft (3.05 m) of any power line rated 50 kV or lower whether it is energized or not. For lines rated over 50 kV, the minimum clearance shall be 10 ft (3.05 m) plus 0.4 in (1.1 cm) for each kV over 50 kVs.
- Never assemble, tow, transport or allow irrigation machine components underneath or within 10 ft (3.05 m) of any power line rated 50 kV or lower whether it is energized or not. For lines rated over 50 kV, the minimum clearance shall be 10 ft (3.05 m) plus 0.4 in (1.1 cm) for each kV over 50 kVs. Overhang support angles, cables and spinner drive components regularly extend 10 ft to 12 ft (3.1 m to 3.7 m) above the irrigation pipeline (span).
- Use barricades to identify areas where interference with overhead power lines could occur. Keep the assembly, towing or transporting of irrigation machine components and the operation of equipment including load, ropes or tag lines away from any power line, in the distances described above, whether the line is energized or not.
- Always designate a person to observe clearance between the power line and all equipment being operated or moved in order to give timely warning for all operations to STOP if the minimum clearance is violated.

Minimal Lockout / Tagout Procedure

The following procedure establishes the minimum requirements for the lockout of energy isolating devices whenever maintenance or servicing is done on machines or equipment. It is used to ensure that the machine or equipment is stopped, isolated from all potentially hazardous energy sources and locked out before personnel perform any servicing or maintenance where the unexpectedly energized or start-up of the machine or equipment or release of stored energy could cause injury. All personnel, upon observing a machine or piece of equipment which is locked out to perform servicing or maintenance, shall not attempt to start, energize, or use that machine or equipment.

When the energy isolating devices are not lockable, tagout should be used and affected personnel must wear full personal protection.

Refer to U.S. Occupational Safety & Health Administration (OSHA) Regulations (Standards - 29 CFR) Typical minimal lockout procedures - 1910.147 App A, or applicable national, state or local regulations, for additional information.

Sequence of Lockout

1. Notify all affected personnel that servicing or maintenance is required on a machine or equipment and that the machine or equipment must be shut down and locked out to perform the servicing or maintenance.
2. The authorized personnel shall identify the type and magnitude of the energy that the machine or equipment utilizes, shall understand the hazards of the energy, and shall know the methods to control the energy.
3. If the machine or equipment is operating, shut it down by the normal stopping procedure (depress the stop button, open switch, close valve, etc.).
4. De-activate the energy isolating device(s) so that the machine or equipment is isolated from the energy source(s).
5. Lock out the energy isolating device(s) with assigned individual lock(s).
6. Stored or residual energy (such as that in capacitors, springs, elevated machine members, rotating flywheels, hydraulic systems, and air, gas, steam, or water pressure, etc.) must be dissipated or restrained by methods such as grounding, repositioning, blocking, bleeding down, etc.
7. Ensure that the equipment is disconnected from the energy source(s) by first checking that no personnel are exposed, then verify the isolation of the equipment by operating the push button or other normal operating control(s) or by testing to make certain the equipment will not operate.



CAUTION

- RETURN OPERATING CONTROL(S) TO THE NEUTRAL OR OFF POSITION AFTER VERIFYING THE ISOLATION OF THE EQUIPMENT.

9. The machine or equipment is now locked out.



DANGER

- WHEN PERSONNEL WILL BE EXPOSED TO CIRCUIT ELEMENTS AND ELECTRICAL PARTS, A QUALIFIED PERSON MUST USE TEST EQUIPMENT TO VERIFY THAT THE CIRCUIT ELEMENTS AND EQUIPMENT PARTS OF THE EQUIPMENT ARE DE-ENERGIZED.

Restoring Equipment to Service

When the servicing or maintenance is completed and the machine or equipment is ready to return to normal operating condition, the following steps shall be taken:

1. Check the machine or equipment and the immediate area around the machine to ensure that non-essential items are removed and that the machine or equipment components are operationally intact.
2. Check the work area to ensure that all personnel are safely positioned or removed from the area.
3. Verify that the controls are in neutral.
4. Remove the lockout devices and re-energize the machine or equipment.
5. Notify affected personnel that the servicing or maintenance is completed and the machine or equipment is ready to be used.

Safety

Operate Safely

Valley Irrigation machines are designed with safety in mind. However, if this machine is operated incorrectly, it may pose a safety threat to the operator. A good safety program is much like a chain, it is only as strong as its weakest link. The manufacturer, dealer, and operator must maintain and improve all safety programs. The following is a list of safety operating tips which you and all other persons servicing or operating the machine must read and understand.

CAUTION

- **DO NOT OPERATE THIS MACHINE WITHOUT FIRST READING THE OWNER'S MANUALS FOR THE MACHINE.**
- **READ ALL SAFETY MESSAGES IN THIS MANUAL AND SAFETY SIGNS ON THE MACHINE.**
- **DO NOT LET ANYONE OPERATE THIS MACHINE WITHOUT PROPER INSTRUCTIONS.**
- **UNAUTHORIZED MODIFICATIONS MAY IMPAIR THE FUNCTION AND/OR SAFETY OF THE MACHINE.**
- **IF YOU DO NOT UNDERSTAND ANY PART OF THIS MANUAL, CONTACT YOUR VALLEY DEALER.**

Employee Instruction on Safety

It is very important to instruct your employees on the safe use of this equipment at the time of their initial assignment to operate it. **DO NOT** let anyone operate this equipment without proper instructions.

Safety training should be presented annually and the service manager should ensure employees fully understand the safety messages and what to do in case of emergencies.

Emergency Stopping

The machine can be stopped at any time at any tower by turning the disconnect switch, located underneath the tower box, to the Off position. See Figure 14-1.

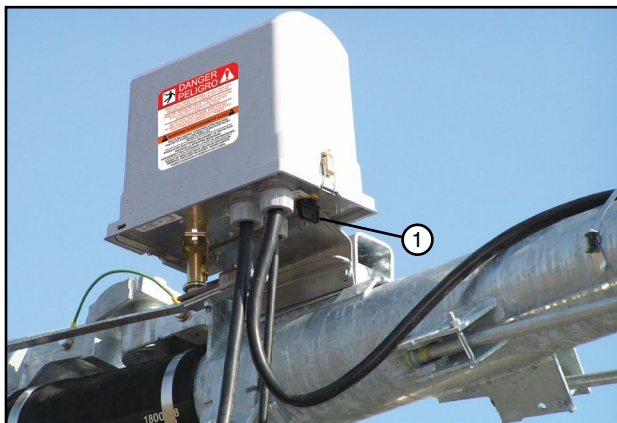

Figure 14-1 1. Disconnect Switch

WARNING

Proper Grounding

DO NOT attempt to start the machine until the electrical service is properly installed and grounded by a qualified electrician as per the electrical standards. See Figure 14-2.

If the power supplied to the machine is not grounded properly, severe injury or death can result should an electrical malfunction occur.

It is your responsibility to ensure that your power supplier and/or electrical contractor has grounded the irrigation machine as required by the National Electrical Code and by applicable local electrical codes. If a machine is properly grounded and fuse sizing is correct, there is extremely low probability of an individual being injured by electrical shock.

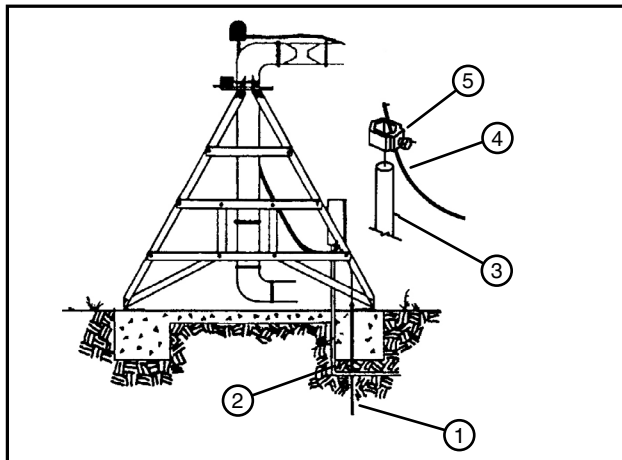

Figure 14-2 1. Ground Rod Installation 2. Service Conductor 3. Copper Ground Rod 4. Copper Ground Wire 5. Clamp

NOTE

- **All 480 VAC, 60 Hz (380 VAC, 50 Hz) power supply services MUST be a 4 conductor service. Three 480 VAC (380 VAC) power lines and one ground conductor which is as large as the power carrying conductors for that service.**
- **Each time a towable machine is moved, the ground wire MUST be reattached to the ground rod and checked for electrical integrity before restarting the machine.**

Operate Safely (continued)

DANGER

Disconnect Power When Servicing

ALWAYS disconnect electrical power before servicing or performing maintenance to the machine.

If you are going to perform maintenance on the machine, **YOU MUST** shut off and lock the main power disconnect as shown below. See Figure 15-1.

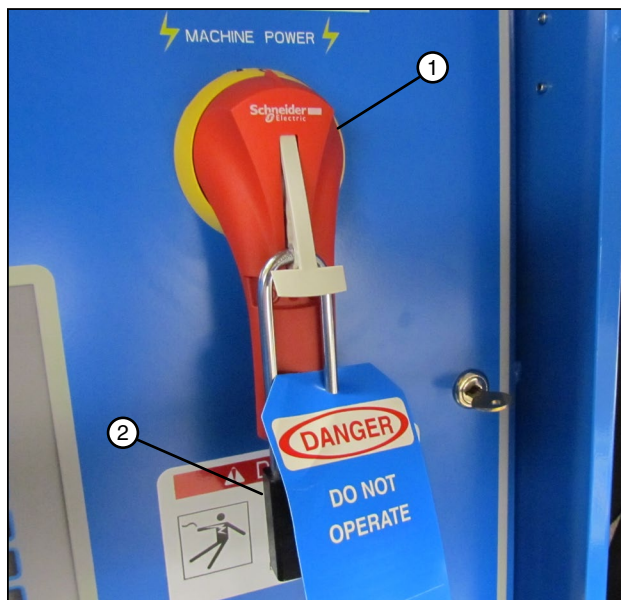

Figure 15-1 1. Main Power Disconnect
2. Lock

The blue (OSHA safety color code) tag shown below should also be filled out and attached to the disconnect after locking. See Figure 15-2.

The tag should reveal the name of a person to contact before restoring power to the machine.



Figure 15-2

CAUTION

Qualified Service Personnel

If you do not understand electricity or other parts of the machine, have qualified service personnel perform any hazardous repairs or maintenance.

CAUTION

Guard All Power Take-Off Drives

This includes all belt and power line drives.

Replace any guards and shields removed for maintenance.

WARNING

Mark and Guard All Power Lines

Do NOT deep rip or chisel near the buried power service wires.

Do NOT deep rip in a circle at the drive unit. The deep chisel track will cause severe stresses on the structure.

If you do deep rip your field, run the machine with the percent timer at 100% for the first revolution.

WARNING

Suspected Short Circuits

DO NOT touch the machine if you suspect a short-circuit situation. Call a qualified electrician or an authorized Valley dealer immediately.

Circumstances which may cause you to suspect hazardous voltage situations may include:

- Physical damage to the machine or span cable
- Recent electrical storms (lightning)
- Unusual operating characteristics of the machine

If you suspect a short circuit due to feeling a rippling tingle when touching the machine, DO NOT touch the machine again. Call a qualified electrician or an authorized Valley dealer immediately.

Safety

Operate Safely (continued)

WARNING

Lightning and the Machine

Stay away from the machine during an electrical storm. An irrigation machine makes a good path to earth. It is also probably the tallest object in the field, which makes it a good lightning receptor!

CAUTION

Do Not Oversize Fuses

Fuses are sized for the protection of a specific machine.

Be certain you have the proper fuse sizes in place before initial start-up and when replacing fuses.

CAUTION

Plug - In Connectors

Disconnect power before connecting or disconnecting any plug-in connectors.

CAUTION

Do Not Operate at Freezing Temperatures

Spraying water has a cooling effect and water will freeze even though the air temperature is slightly above freezing.

Shut the machine down at 40 degrees Fahrenheit (4.5 degrees Celsius). Do not operate machine when temperature is below 40° F (4.5° C).

- **DAMAGE TO EQUIPMENT RESULTING FROM FREEZE-UP IS NOT COVERED UNDER WARRANTY.**
- **IT IS IMPORTANT TO MAKE SURE ALL PIPE DRAINS FUNCTION PROPERLY TO PREVENT PIPELINE FREEZE-UP DURING COLD WEATHER.**

CAUTION

Avoid High Pressure Water Streams

Avoid body contact with high pressure water streams.

WARNING

Avoid Chemicals

Avoid exposure to sprinkler spray while chemicals are being injected into the water. Read EPA Label Improvement Program (PR Notice 87-1) and all instructions for chemical applications.

If you plan on chemigating, make certain you have complied with state or local regulations in regard to safety equipment, certification, operation and calibration of the injector pump. Make certain you have first aid and fresh water available in case of an accident. You must also be familiar with the correct cleanup procedures in case of a spill.

- **USE OF PROTECTIVE CLOTHING IS RECOMMENDED WHEN HANDLING CHEMICALS. SAFETY GLASSES, GLOVES, AND PROTECTIVE OUTERWEAR SHOULD BE WORN WHEN HANDLING CHEMICALS.**
- **CONTAMINATION OF THE WATER SUPPLY MAY OCCUR IF EFFECTIVE SAFETY DEVICES ARE NOT INSTALLED/USED IN CONNECTION WITH INJECTION EQUIPMENT FOR CHEMIGATION.**

DANGER

Drive Shafts Start Without Warning

An electric motor on each tower of the center pivot powers two or more drive shafts connected to wheel gear drives. These drive shafts start and stop without warning.

- **DO NOT TOUCH ROTATING DRIVE SHAFT OR SHIELD, CLOTHING OR LIMBS MAY BECOME ENTANGLED, RESULTING IN SEVERE INJURY.**
- **DO NOT SERVICE THE MACHINE UNTIL THE MAIN DISCONNECT IS LOCKED IN THE OFF POSITION.**
- **ALWAYS REPLACE DRIVE SHAFT SHIELDS AFTER SERVICING.**
- **DRIVE SHAFT SHIELDS MUST ALWAYS BE IN PLACE WHEN OPERATING THE MACHINE.**

Operate Safely (continued)

CAUTION

Check Wheel Tracks Before Starting

Make sure all objects, livestock or persons are clear of the machine before starting. Drive trains are powerful and can climb over vehicles, equipment, etc.

CAUTION

Keep Children Away

Pivots are NOT playground equipment.

Prevent children from playing or climbing around on the machine. This can be extremely dangerous, especially if the machine is operating.

CAUTION

Check Machine Direction

DO NOT operate the machine if it moves in the direction opposite to that which was chosen.

Forward should be clockwise and reverse counter-clockwise.

CAUTION

Keep Water Off Roadways

It is against the law in most states to allow water to spray on state and county roadways. This is a serious hazard to passing motorists.

If end guns are used, make sure you read and understand the correct procedures for setting the on and off positions to avoid watering the roadways.

If an end gun is watering a roadway, immediately discontinue use and adjust the shutoff setting or call your Valley dealer to repair the end gun shut off mechanism.

CAUTION

Part Circle Operation Safety

If the machine reverses direction at a roadway or a physical object such as a building, tree line, power pole, etc., then you MUST provide a backup device to stop the machine if the reversing mechanism were to fail. See Figure 17-1.

Contact your Valley dealer for more information concerning physical barricades for machines under these circumstances.



Figure 17-1 1. Physical Barricade

CAUTION

Proper Use of the Safety Override

Caution MUST be taken by the operator when using the safety override function as it will bypass or disable all of the machine's automatic safety shutdown circuits.

- **NEVER DEPRESS AND HOLD THE START/STOP SAFETY OVERRIDE SWITCH IN THE START POSITION FOR MORE THAN 3 TO 5 SECONDS.**

If the machine is not in full view by the operator, do not use the Safety Override function.

The operator MUST inspect the entire machine between each safety override start attempt.

Repeated safety override start attempts can cause severe structural damage.

Call your Valley dealer if the machine fails to start.

Safety

Safety Decals

These Danger, Warning, and Caution decals appear in various locations on a Valley irrigation machine. You MUST familiarize yourself and other operators with these safety decals. For replacement of any decal, contact your local Valley dealer.

ICON5

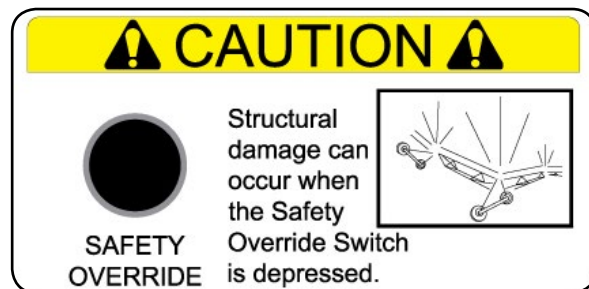
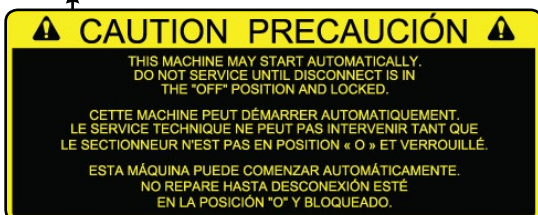
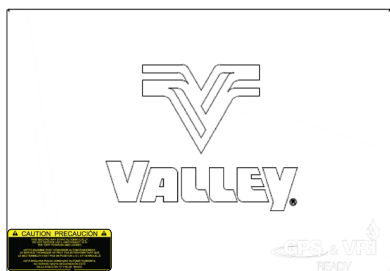
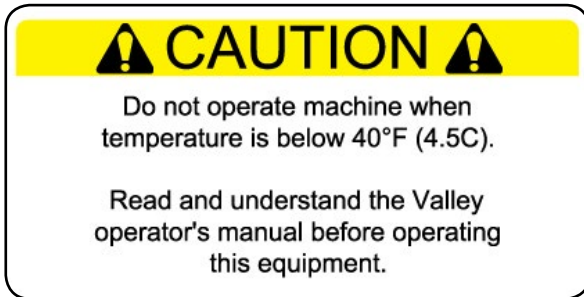
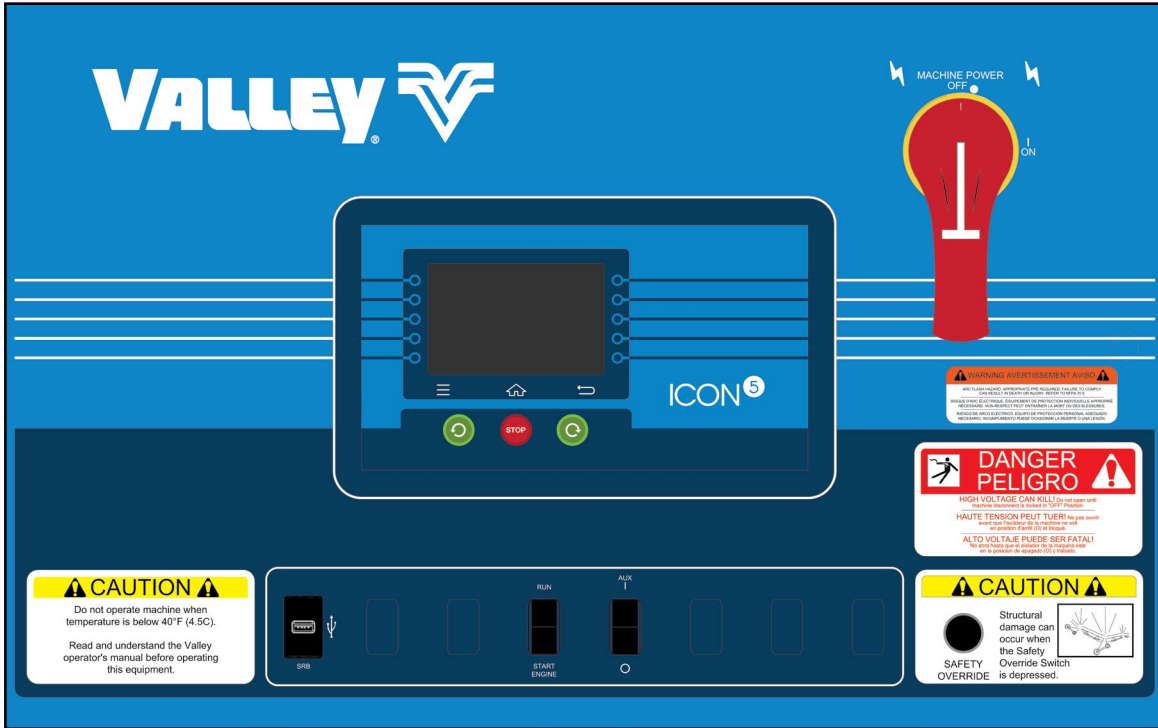

Safety Decals (continued)

ICONX

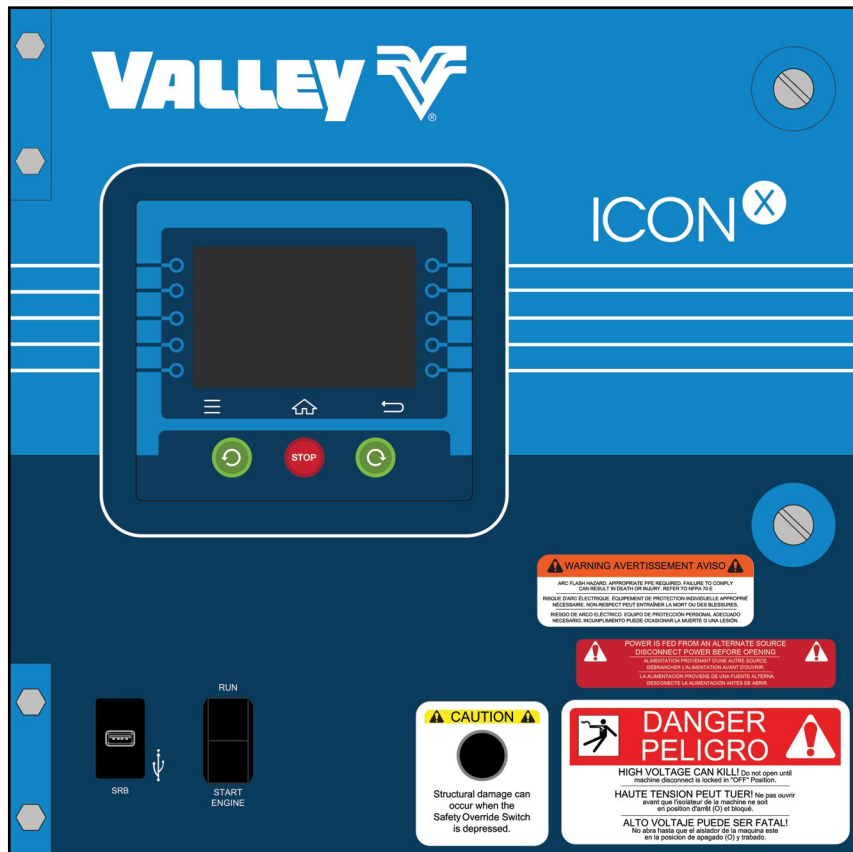

Safety

Safety Decals (continued)

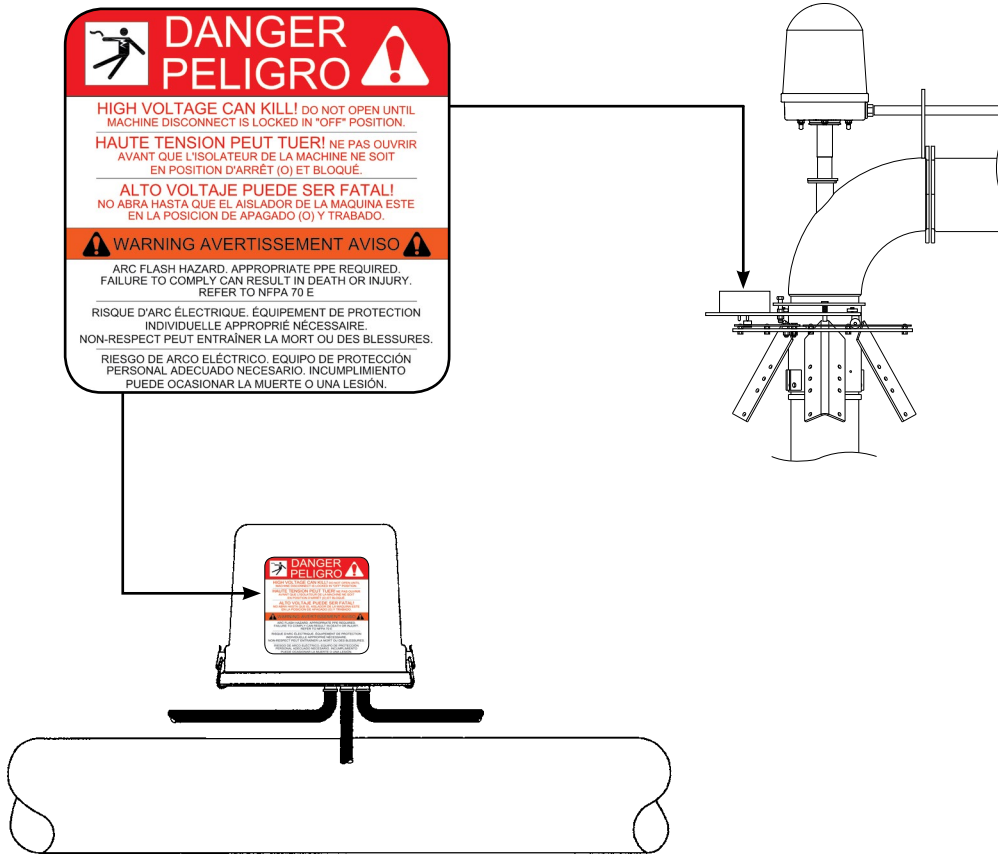

⚠️ WARNING

TIRE AND RIM FOR IRRIGATION USE ONLY.
 ADJUST PRESSURE BEFORE USE. SEE OWNERS MANUAL FOR RECOMMENDED PRESSURE.
 18 PSI [1.2 BAR] MAXIMUM

VALLEY

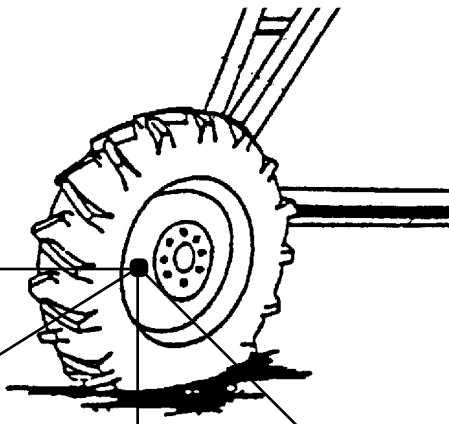

⚠️ WARNING

TIRE AND RIM FOR IRRIGATION USE ONLY.
 ADJUST PRESSURE BEFORE USE. SEE OWNERS MANUAL FOR RECOMMENDED PRESSURE.
 23 PSI [1.6 BAR] MAXIMUM

VALLEY

⚠️ WARNING

TIRE AND RIM FOR IRRIGATION USE ONLY.
 ADJUST PRESSURE BEFORE USE. SEE OWNERS MANUAL FOR RECOMMENDED PRESSURE.
 30 PSI [2.1 BAR] MAXIMUM

VALLEY

⚠️ WARNING

TIRE AND RIM FOR IRRIGATION USE ONLY.
 ADJUST PRESSURE BEFORE USE. SEE OWNERS MANUAL FOR RECOMMENDED PRESSURE.
 34 PSI [2.3 BAR] MAXIMUM

VALLEY

Safety Decals (continued)

⚠ WARNING

Improper installation of this motor may result in fire, explosion, electrical shock or other personal injuries. Read operating instructions

	Disconnect power before maintenance. Open all circuits before removing conduit box cover. Be sure motor is properly grounded per local and national codes.
	Do not place fingers or objects near openings.
	Do not use eye bolts or lifting hooks to lift anything except the product.

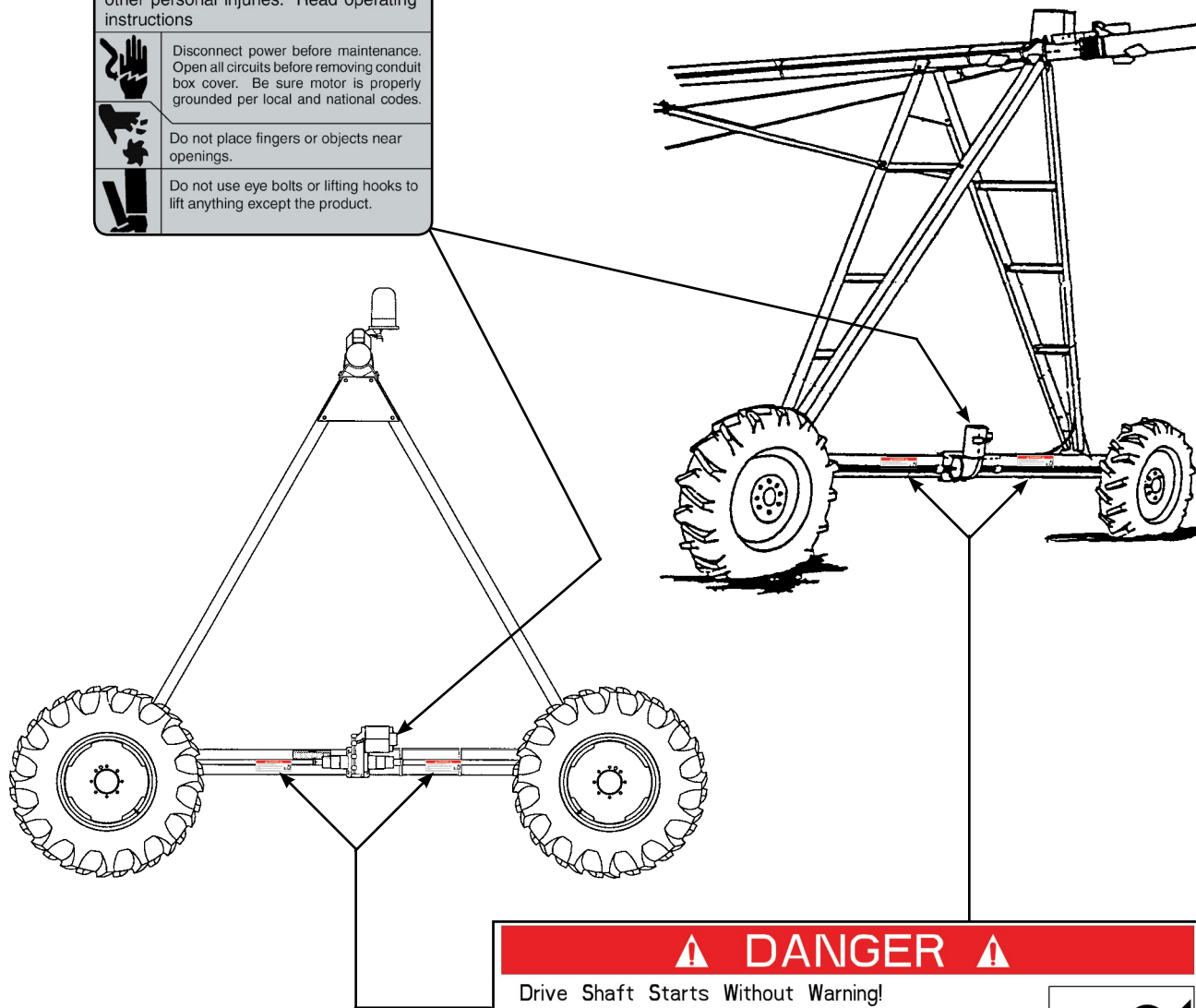

⚠ DANGER ⚠

Drive Shaft Starts Without Warning!

- Do not touch rotating drive shaft or shield. Clothing or limbs may become entangled, resulting in severe injury.
- Do not service until machine is locked in the off position.
- Always replace drive shaft shield after servicing.



Overview

The pages in this section provide a brief description of the control panel components and controls.

ICON5 Control Panel

This Valley ICON5 control panel uses an ICON5 module for executing operator commands. See Figure 22-1.

Main Disconnect

This switch disconnects all power to the machine except at the incoming (upper) terminals on the Main Disconnect Switch inside the control panel. The function of this switch is to turn the power on or off. See Figure 22-1.

Safety Override Switch

The machine's safety circuit can be overridden by depressing this switch in conjunction with the start button. See Figure 22-1.

WARNING

- NEVER DEPRESS THE SAFETY OVERRIDE SWITCH FOR LONGER THAN THREE SECONDS AT ANY TIME. USING THE SAFETY OVERRIDE CAN CAUSE SERIOUS STRUCTURAL DAMAGE. CALL YOUR LOCAL VALLEY DEALER, SHOULD YOUR MACHINE FAIL TO START.

3-Second Delay Timer

A three-second delay timer is standard equipment built into the circuitry of the control panel.

In the event of a momentary power loss or voltage drop, the machine will remain running if power returns within three seconds.

Pump Restart Delay

When the control panel also controls an irrigation pump that is set to automatically start, the irrigation pump must be protected from damage with a pump restart delay. The pump restart delay must be in the pump circuit between the irrigation machine control panel and the pump.

CAUTION

- TO REDUCE THE POSSIBILITY OF DAMAGE TO AN AUTOMATICALLY CONTROLLED ELECTRIC PUMP DUE TO A MOMENTARY POWER LOSS OF 3 SECONDS OR LESS, A PUMP RESTART DELAY IS REQUIRED IN THE PUMP CIRCUIT BETWEEN THE IRRIGATION MACHINE CONTROL PANEL AND THE PUMP.

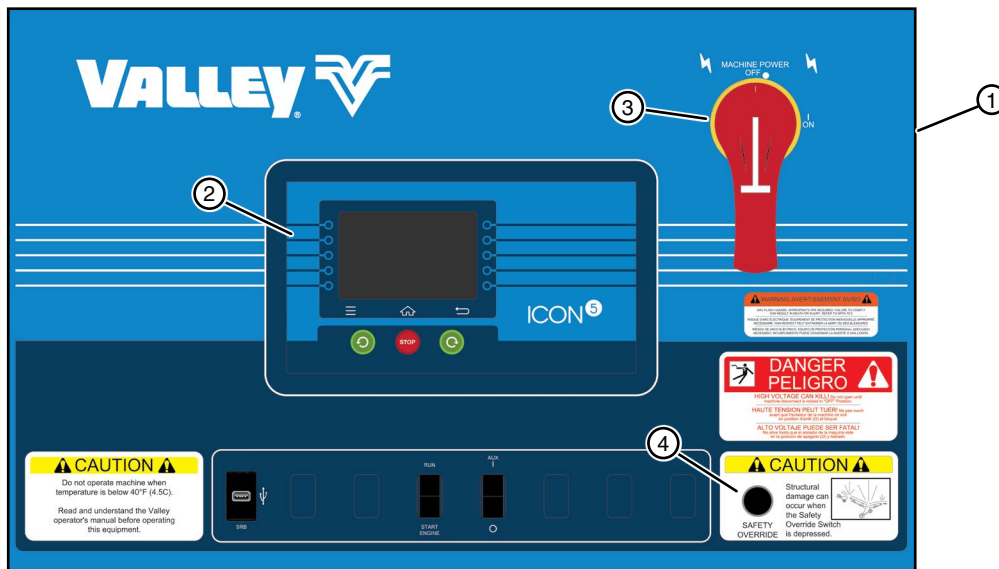

Figure 22-1 1. Control Panel 3. Main Disconnect Switch
2. ICON5 Module 4. Safety Override Switch

ICONX Control Panel

This Valley ICONX control panel contains an ICON5 module and is used with an existing control panel for executing operator commands. See Figure 23-1.

Main Disconnect

The ICONX control panel must be located within 50 ft (15.2 m) of the existing control panel Main Disconnect Switch. This switch must disconnect all power to the machine except at the incoming (upper) terminals on the Main Disconnect Switch inside the existing control panel. The function of this switch is to turn the power on or off. See Figure 23-1.

Safety Override Switch

The machine's safety circuit can be overridden by depressing this switch in conjunction with the start button. See Figure 23-1.

⚠ WARNING

- NEVER DEPRESS THE SAFETY OVERRIDE SWITCH FOR LONGER THAN THREE SECONDS AT ANY TIME. USING THE SAFETY OVERRIDE CAN CAUSE SERIOUS STRUCTURAL DAMAGE. CALL YOUR LOCAL VALLEY DEALER, SHOULD YOUR MACHINE FAIL TO START.

3-Second Delay Timer

A three-second delay timer is standard equipment built into the circuitry of the ICONX control panel. In the event of a momentary power loss or voltage drop, the machine will remain running if power returns within three seconds.

Pump Restart Delay

When the control panel also controls an irrigation pump that is set to automatically start, the irrigation pump must be protected from damage with a pump restart delay. The pump restart delay must be in the pump circuit between the irrigation machine control panel and the pump.

⚠ CAUTION

- TO REDUCE THE POSSIBILITY OF DAMAGE TO AN AUTOMATICALLY CONTROLLED ELECTRIC PUMP DUE TO A MOMENTARY POWER LOSS OF 3 SECONDS OR LESS, A PUMP RESTART DELAY IS REQUIRED IN THE PUMP CIRCUIT BETWEEN THE IRRIGATION MACHINE CONTROL PANEL AND THE PUMP.

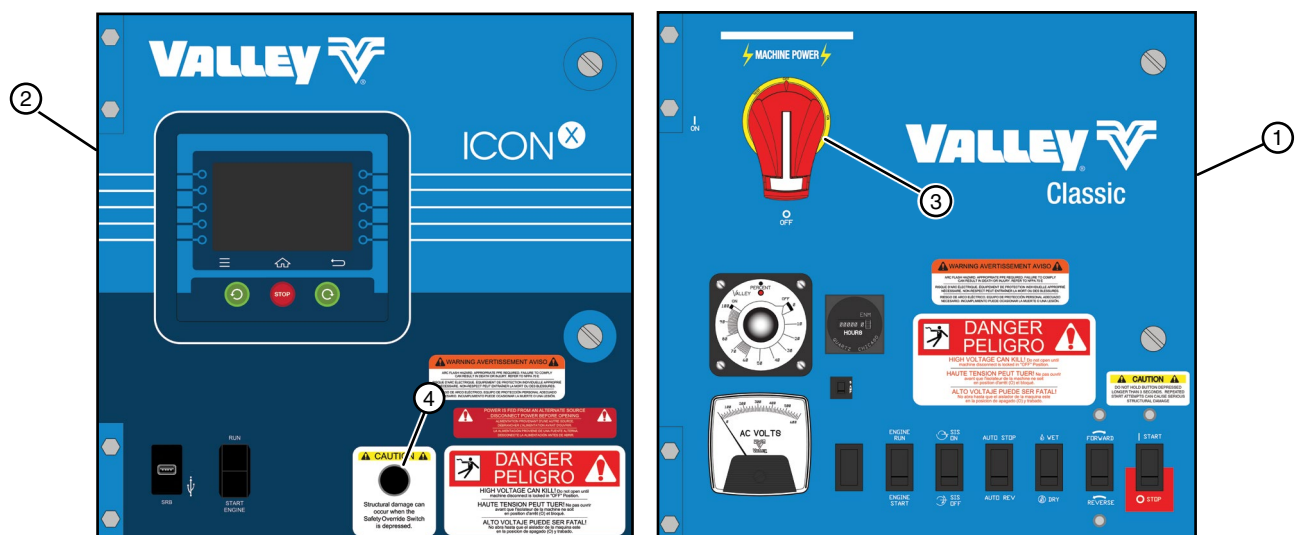

Figure 23-1 1. Classic Control Panel 2. ICONX Control Panel 3. Main Disconnect Switch 4. Safety Override Switch

Overview

Main Screen

The Main Screen is where you begin operating your irrigation machine, and where you learn its current status. Controls are located on the left side of the screen, the machine's current status is located on the right side of the screen, Soft Keys on either side of the screen and the Menu, Home, Back, Start and Stop buttons are located below the screen. See Figure 24-1, which represents a typical main screen. The following pages describe the elements that can appear on the Main Screen. **The Controls and Status fields can be customized and may look different than what is shown in Figure 24-1.**

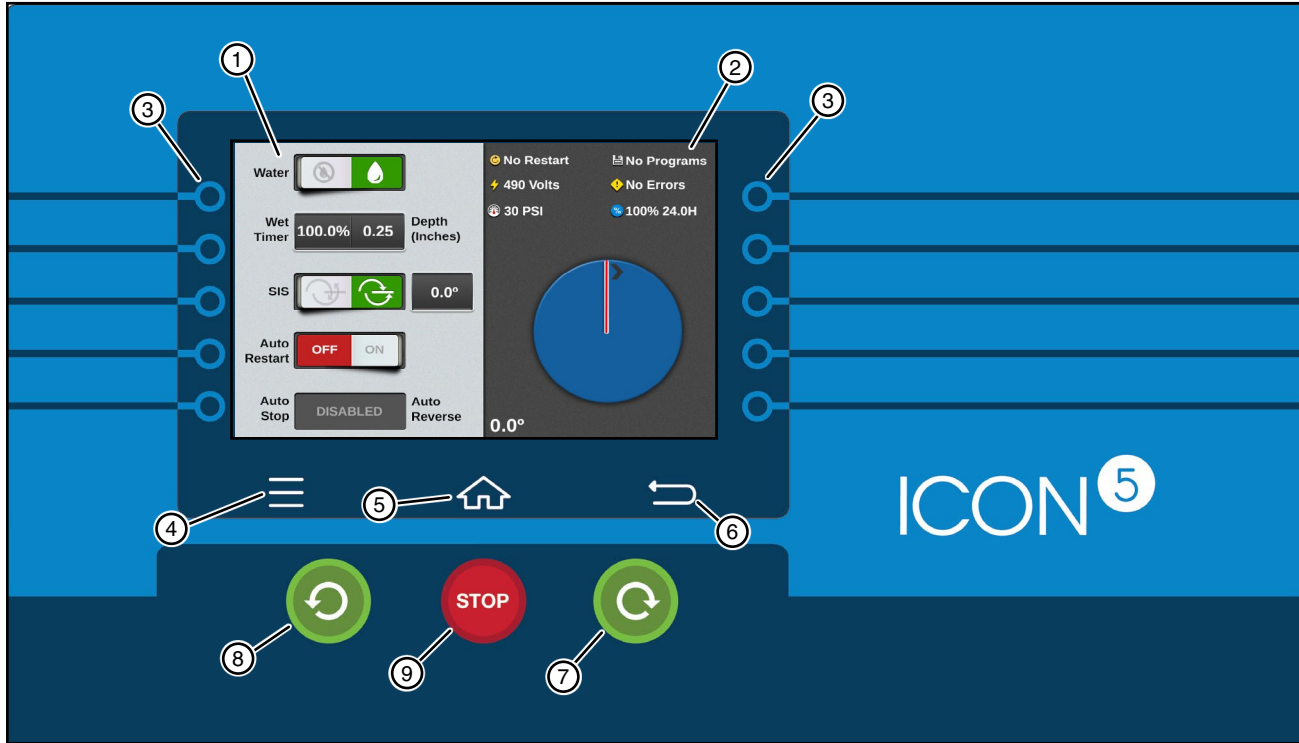









Figure 24-1 ICON5 Screen Shown

Controls - Item 1		Up to five control buttons can appear on the left side of the screen for programming and operating the machine.
Status - Item 2		Up to six statuses can appear on the right side of the screen. Below the statuses is a graphic image depicting the machine's current position.
Soft Keys - Item 3		Soft keys are located in line with control and menu buttons and can be used as an alternate instead of pushing the on-screen button.
Menu - Item 4		Use the Menu button to access Controls, Status, End Guns, Setup, System, Utilities and Program related menus.
Home - Item 5		This button will return to the Main Screen.
Back - Item 6		Backs up one level while in Menus or Keypad. Does not back out of a screen.
Start Forward - Item 7		Push to start the machine and move in the forward (clockwise) direction.
Start Reverse - Item 8		Push to start the machine and move in the reverse (counter-clockwise) direction.
Stop - Item 9		Push to halt machine movement, shut pump off, and close water valve (if wired to do so).The machine has a time delay that prevents it from restarting when you press a start button within five seconds after stopping the machine with water on.

Main Screen (continued)

Control Buttons

Up to five control buttons can be selected to appear on the left side of the screen for operating the machine. You can access all the control buttons by pushing **Menu** and **Controls**.

Below are descriptions of each available control button. It is very important to understand that, the control button indicates what the machine is currently doing.

Water



Water On - The pump and/or close water valve are currently on (if wired to do so). Push to turn them off.



Water Off - The pump and/or close water valve are currently off. Push to command pump to turn on, valve to open, or both, when machine starts (if wired to do so).

A pre-programmed pressure delay is automatically recalled to allow sufficient time for pressure to build up in the machine before it moves.

% Timer/Depth



Wet % Timer/Depth Field - When water is on, select the right side of the field for Depth and enter the water application depth by inches or millimeters, or select the left side of the field for Wet % Timer and adjust the percent to obtain the desired application depth. The percent timer indicates the percentage of time which the end tower runs.



Dry % Timer Field - When water is off, select the Dry % Timer field and adjust the percent to obtain the desired speed of travel. The percent timer indicates the percentage of time which the end tower runs.

Cruise (Hrs)



Cruise (Hrs) - On - Cruise is on. Push to turn off.



Cruise (Hrs) Off - Cruise is off. Push to turn on.



Cruise (Hrs) Field - When Cruise is on, select the Cruise (Hrs) field to set the number of hours to complete one pass.

Stop-In-Slot

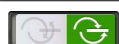

Stop-In-Slot On - Stop-In-Slot is on and will stop the machine at a preset location in the field that is user selected. Push to turn Stop-In-Slot off.



Stop-In-Slot Off - Stop-In-Slot is off. Push to turn Stop-In-Slot on.



Stop-In-Slot Field - When Stop-In-Slot is on, select the Stop-In-Slot field to set the angular location of the Stop-In-Slot.

Auto Restart



Auto Restart On - Automatic Restart is on. Push to turn off.



Auto Restart Off - Automatic Restart is off. Push to turn on.

Auxiliary 1 and 2



Aux On - The Auxiliary is on. Push to turn off.



Aux Off - The Auxiliary is off. Push to turn on.

Auto Reverse/Auto Stop



AR/AS Disabled - Auto Reverse/Auto Stop is disabled. Push **Menu, Utilities, AR/AS, Config ARAS, Auto Reverse / Auto Stop** to enable.



Auto Reverse On - Auto Reverse is on. Push to turn Auto Stop on.



Auto Stop On - Auto Stop is on. Push to turn Auto Reverse on.

End Gun



End Gun Auto - When end gun is set to Auto the selected end gun is enabled and ready. Push to turn off (disable).



End Gun Off - The end gun is off (disabled). Push to turn auto on (enable).

Overview

Main Screen (continued)

Status

Up to four statuses can be configured below Restart and Programs which are fixed statuses. Below the statuses is a graphic image depicting the machine's current position. A description of each field and all the statuses appear below.

The Status section illustrates the operating conditions of a typical irrigation machine example.

The Status section of your machine will show different conditions.

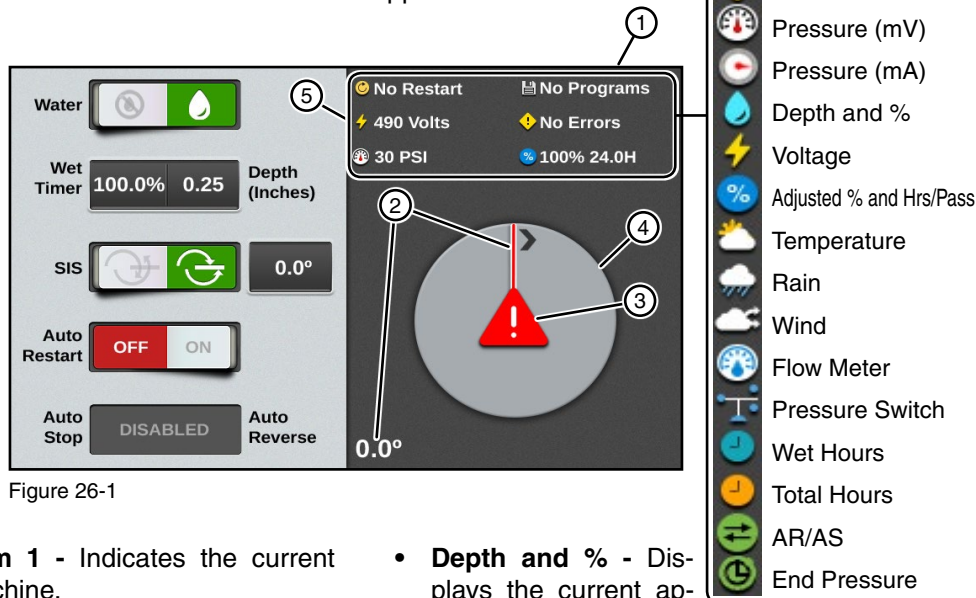

Figure 26-1

Machine Status - Item 1 - Indicates the current known status of the machine.

Pivot Position - Item 2 - Indicates the machine location in the field. The location of the machine is expressed in degrees.

Fault Notice - Item 3 - Indicates whether any system faults have occurred. You can access the System Faults screen by pushing the icon.

Pivot Status - Item 4 - A color is displayed on the pivot graphic to represent the current known status of the machine. Refer to "Pivot Circle Colors and Shapes" on page 29.

Status Icons - Item 5

- **Restart** - Either No Restart or Restart. Restart indicates that the machine could restart due to Auto Restart, Cycle Repeat Restart or Daily Ops Restart.
- **Programs** - Either No Programs or Programs. Programs indicates that programs are currently running.
- **VRI** - Indicates that a VRI-S, VRI-Z, VRI-iS or Cruise program is running.
- **Errors** - Either No Errors or Errors. Errors indicates that an error has occurred.
- **Pressure (mV)** - Indicates the current water pressure at the (mV) pressure sensor. A (mV) pressure sensor is required.
- **Pressure (mA)** - Indicates the current water pressure at the (mA) pressure transducer. A (mA) pressure sensor is required.

- **Depth and %** - Displays the current application Depth and Percent.
- **Voltage** - Indicates current operating voltage. The machine shuts down when voltage drops below the Low Voltage Limit.
- **Adjusted % and Hrs/Pass** - Indicates the current Adjusted % timer wet or dry, and the time it will take for the machine to make a pass.
- **Temperature** - Indicates the current outdoor temperature. Requires optional hardware.
- **Rain** - Indicates the current rain total. Requires optional hardware.
- **Wind** - Indicates the speed of the wind in mph or kph. Requires optional hardware.
- **Flow Meter** - Indicates the amount of water, in gallons per minute, that the machine uses to irrigate. Requires optional hardware.
- **Pressure Switch** - Indicates OK when the pressure switch is on, and LOW when switch is off. A mechanical pressure switch is required.
- **Wet Hours** - Indicates the number of hours that the machine was irrigating while running.
- **Total Hours** - Indicates the total number of hours that the machine was running.
- **AR/AS** - Indicates that Auto Reverse or Auto Stop is on.
- **End Pressure** - Indicates the pressure at the end of the machine.

Main Screen (continued)

Menu

The Menu button is located below the screen. Use the Menu button to access other menus or screens that are used to program the panel, view data and select options not frequently used. Below are descriptions of each button.

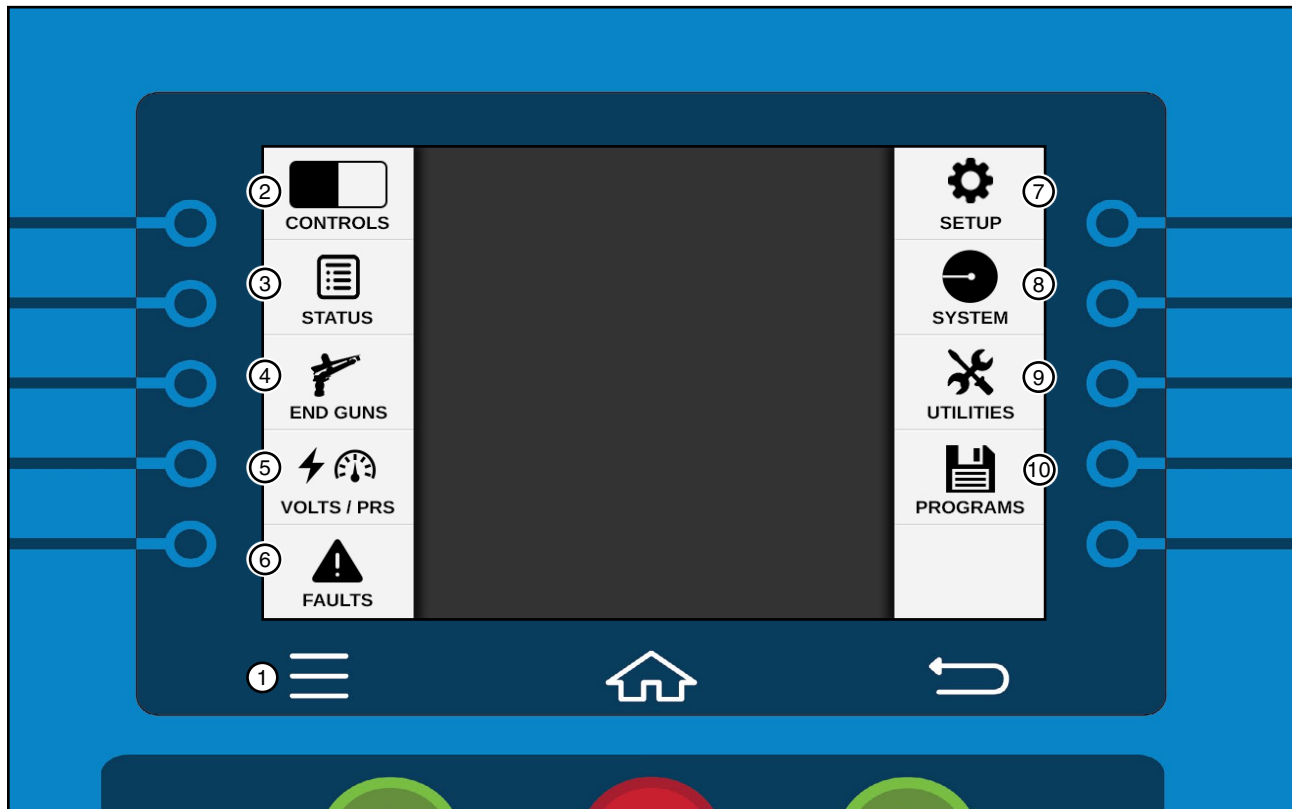











Figure 27-1

Menu - Item 1		Use the Menu button to access Controls, Status, End Guns, Volts / PRS, Faults, Setup, System, Utilities and Program related menus.
Controls - Item 2		Displays all available controls.
Status - Item 3		Displays all current machine statuses.
End Guns - Item 4		Use to enable, disable and configure end guns.
Volts / PRS - Item 5		Displays the current voltage and water pressure.
Faults - Item 6		Displays the current system fault.
Setup - Item 7		Used to input the constant values of the irrigation machine.
System - Item 8		Used to access fault, error and history information.
Utilities - Item 9		Used to configure ARAS, Weather, Notice and TPMS.
Programs - Item 10		Use to either write or run programs that automate specific functions of the machine.

Overview

Main Screen (continued)

Keypad

The keypad is used to input values such as percentage timer setting, water application depth, SIS setting, etc. and is also used for programming the panel. The functions of these buttons are explained below.

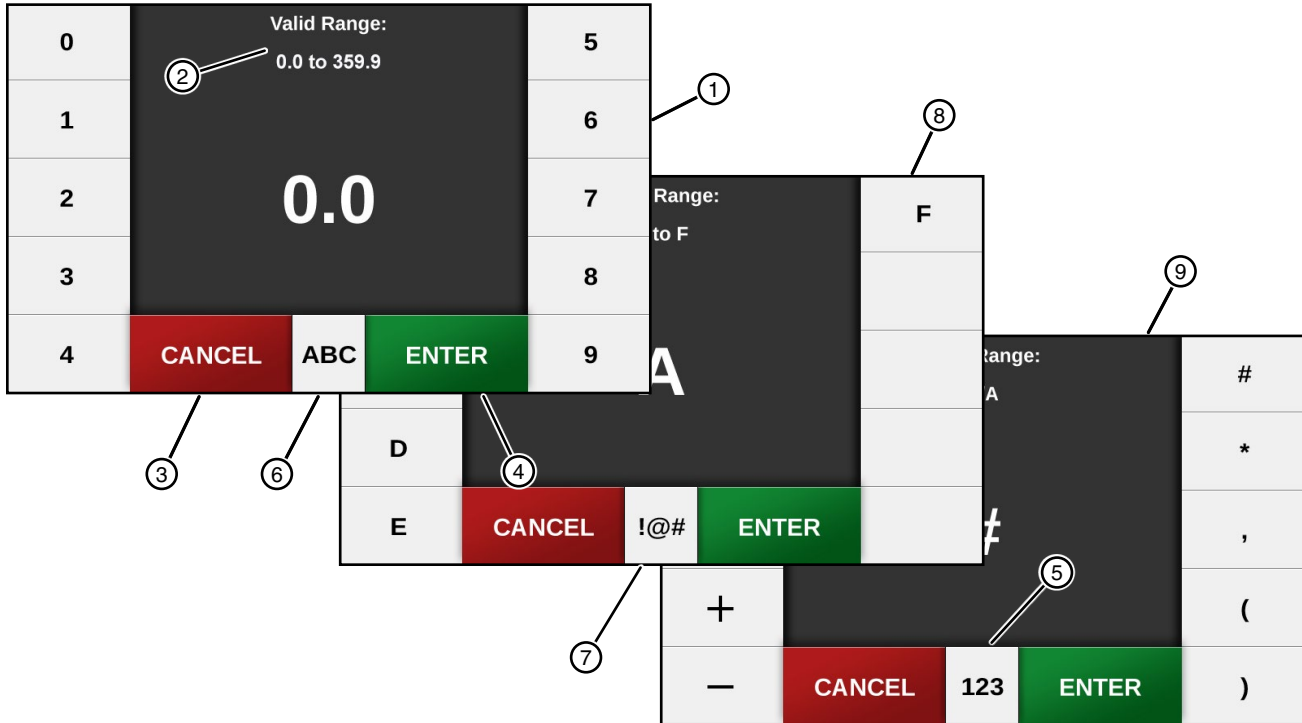







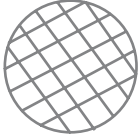

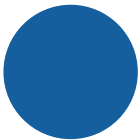

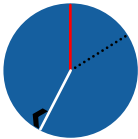



Figure 28-1

Numeric Keypad - Item 1		Used to input numeric values.
Valid Range - Item 2		Displays the range of values that will be accepted.
Cancel - Item 3		Push to step backward from the current screen to a previous screen without performing any changes.
Enter - Item 4		Push at the end of a value entry to retain the value.
Keypad Selection Buttons		Push to toggle between the different keypads.
123 Button - Item 5		Push to display the Numeric keypad.
ABC Button - Item 6		Push to display the Alpha keypad. Also used to toggle between input types.
!@# Button - Item 7		Push to display the Special Character keypad.
Alpha Keypad - Item 8		Used to input Alpha characters A through F.
Special Character Keypad - Item 9		Used for input of positive or negative values or special characters.
Back - Not Shown		Push to back space and delete the previous character.



Main Screen (continued) Pivot Circle Colors and Shapes

The table below and on the next page shows a list of all the colors and shapes the Main Screen uses to represent the current known status of the machine.



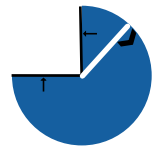
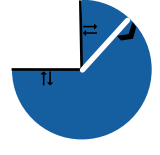

Status	Color And Shape	Graphic
Pivot is stopped	Gray circle	
Program is running	Gray grid appears on the circle. The color of the circle will vary.	
Pivot is running dry	Green circle	
Pivot is running dry, with Auxiliary 1 on	Orange circle	
Pivot is running wet	Blue circle	
Pivot is running wet, with Auxiliary 1 on	Cyan circle	
Pivot representation and position in the field	A white line represents the pivot and its position in the field.	
Direction indicator	A black arrow at the end of the pivot line indicates the direction that the pivot is moving.	
Stop-In-Slot is on	A red line appears in the stop-in-slot location when turned on.	
Pivot road location	An optional black dotted line represents pivot road location when enabled.	
System Fault	A red triangle centered on the pivot represents a System Fault. Push on the triangle to view the system fault.	
Waiting	A yellow triangle centered on the pivot, with a hourglass, represents Waiting.	

Overview

Main Screen (continued) Pivot Circle Colors and Shapes

Status	Color And Shape	Graphic
End Gun Enabled	<p>Enabled State: For each End Gun a different colored line is shown indicating the angle range. The enabled state is visible when the pivot position is outside the angle range. The End Gun must be enabled and the angles must be set. The color of the device will vary.</p> <p>EG1 - yellow indicates EG1 is enabled EG2 - purple indicates EG2 is enabled EG3 - gray indicates EG3 is enabled EG4 - red indicates EG4 is enabled</p>	
End Gun On (active state)	<p>Active State: For each End Gun that is on, a blue line is shown indicating the angle range. The active state is visible when the machine is running and the pivot position is in the angle range. The End Gun must be enabled and the angles must be set. The color of the device will vary.</p> <p>EG1 - light blue indicates EG1 is on EG2 - medium blue indicates EG2 is on EG3 - dark blue indicates EG3 is on EG4 - darkest blue indicates EG4 is on</p>	
Auto Stop On	<p>Position Indicator: A black arrow pointing toward the AR/AS Forward/Reverse Positions. The Position Indicator is only displayed when both the AR/AS and Forward/Reverse Position are enabled.</p>	
Auto Reverse On	<p>Position Indicator: Black arrows pointing toward and away from the AR/AS Forward/Reverse Positions. The Position Indicator is only displayed when both the AR/AS and Forward/Reverse Position are enabled.</p>	

Other Buttons and Functions

Next		Push to go to the next screen within the function.
Previous		Push to go back to the previous screen within the function.
Check Box		Check the check box to enable a function or uncheck the check box to disable a function.
Return		Push to go back to the previous screen.

Display Setup

The steps below and on the following pages explain how to set up the Display and do the following:

- Set the Language and Units of Measure
- Set the Screen Brightness and Sleep Delay Timer
- Set the Date / Time

Language and Units of Measure

1. On the Region screen set the Language, Numeric Format and Units of Measure for Distance, Volume, Temperature and Pressure. See Figure 31-1.

- (a) Push **Menu**, **Setup**, **Display** and **Region**.
- (b) Select the **Language** drop-down menu and choose the language.
- (c) Select a **Unit of Measure** drop-down menu and choose the unit of measure.
 - Distance: Imperial/US or Metric
 - Volume: Imperial/US or Metric
 - Temp: Fahrenheit or Celsius
 - Pressure: PSI or KPA

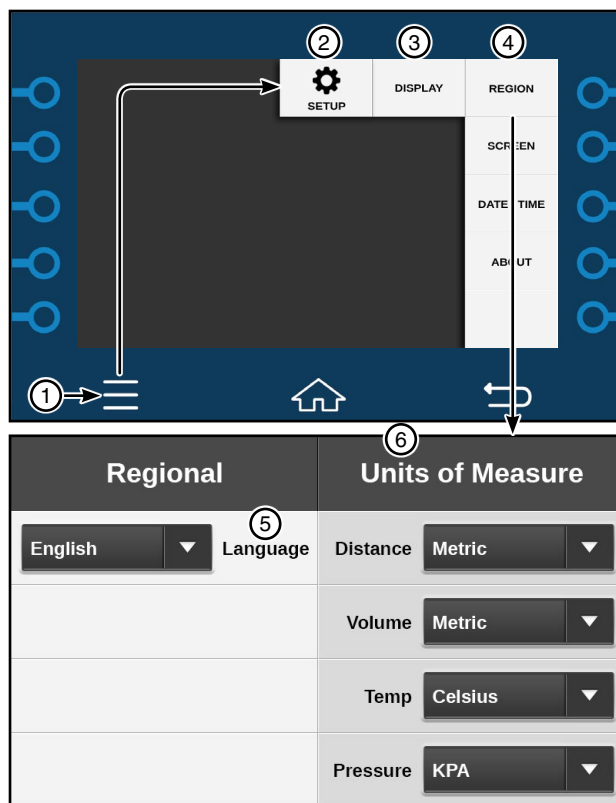

Figure 31-1 1. Menu 4. Region
2. Setup 5. Language
3. Display 6. Unit of Measure

Control Panel Setup

Display Setup (continued)

Screen Brightness and Sleep Delay Timer

2. Use Screen to adjust the Screen Brightness and Display Speed delay timer. See Figure 31-1.
 - (a) Push **Menu**, **Setup**, **Display** and **Screen**.
 - (b) Push the **Darker** or **Lighter** buttons to adjust the brightness of the screen in 5% increments from 25% to 100%.
 - (c) Push the **+ Increase** or **- Decrease** buttons to adjust the Display Sleep delay timer in 1 minute increments from 1 to 10 minutes.

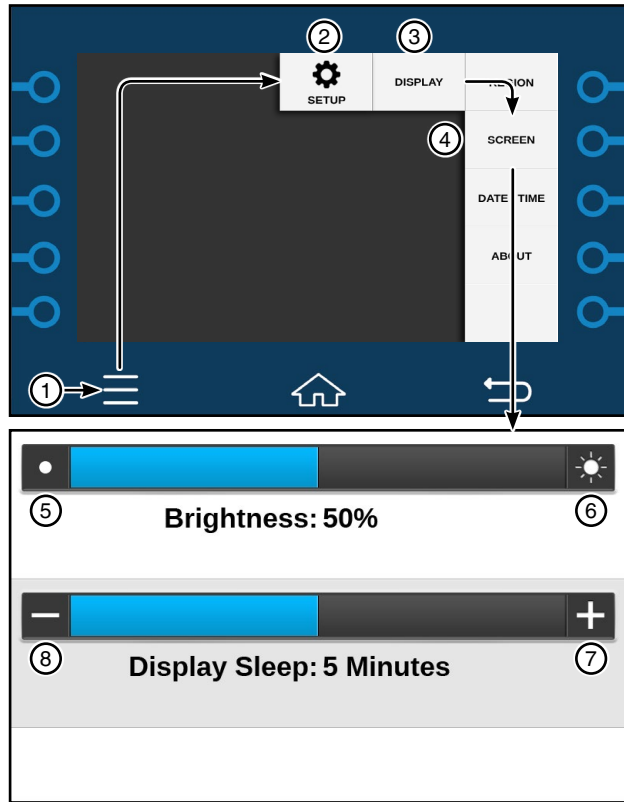

Figure 32-1 1. Menu 5. Darker
2. Setup 6. Lighter
3. Display 7. + Increase
4. Screen 8. - Decrease

Display Setup (continued)

Date / Time

3. On the Date / Time screen you can set the Current Date and Time. See Figure 33-1.

- (a) Push **Menu**, **Setup**, **Display** and **Date/Time**.
- (b) Select the **Date Format** drop-down menu and choose how to display the date.
- (c) Select the **Date** field and enter the day, month and year on the numeric keypad.

NOTE

- The location of the day month and year will change depending on the selected date format.

- (d) Select the **Time** field and enter the hour and minutes on the numeric keypad.
- (e) Push to select **AM** or **PM** (12-hour clock format only).
- (f) Optional, check the **24 Hour Clock** checkbox to display time in the 24-hour format. An empty 24 Hour Clock checkbox indicates a 12-hour format.

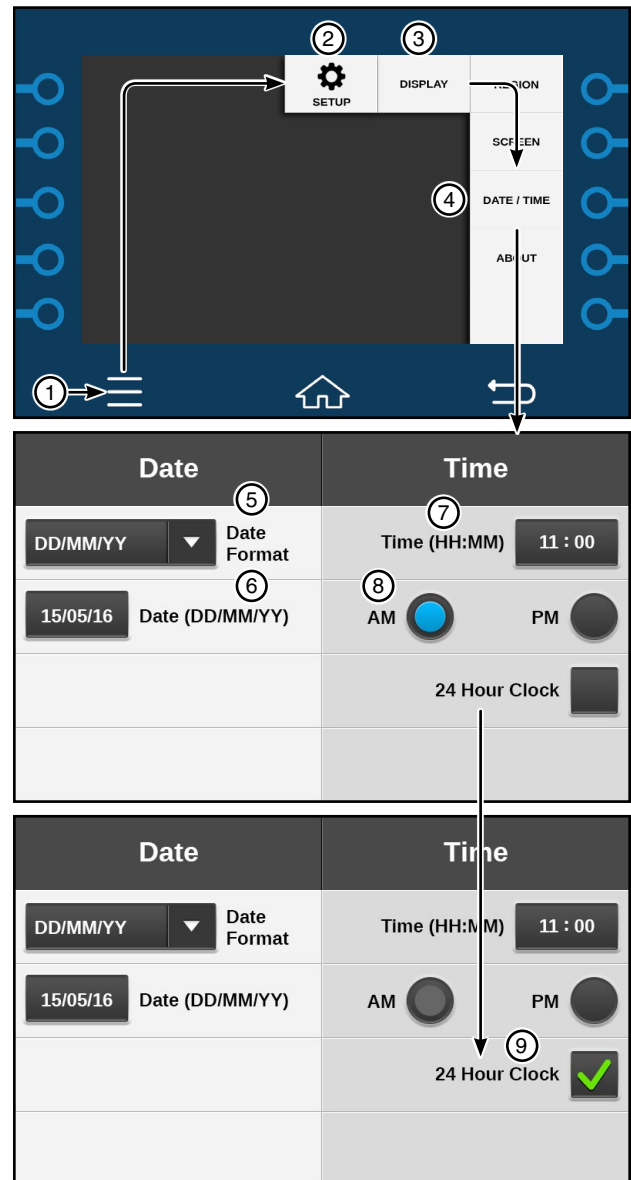

Figure 33-1

1. Menu	5. Date Format
2. Setup	6. Date
3. Display	7. Time
4. Date / Time	8. AM/PM
	9. 24 Hour Clock

Control Panel Setup

Main Screen Setup

The steps below and on the following pages explain how to set up the Main Screen and do the following:

- Add a pivot road, enable or disable part circle and configure part circle angles.
- Select the control buttons and statuses that you want to display on the Main Screen, in the order you want.

Field

1. On the Field screen, you can add the pivot road, enable or disable part circle and configure part circle angles. See Figure 34-1.
 - (a) Push **Menu**, **Setup**, **Main Screen** and **Field**.
 - (b) If desired, check the **Pivot Road** checkbox to enable it.
 - (i) Select the Pivot Road field and enter its position, in degrees, where the road is located on the field using the numeric keypad.
 - (c) If this is a part circle field, check the **Part Circle** checkbox to enable it.
 - (i) Select the **Start Angle** field and enter the angle using the numeric keypad.
 - (ii) Select the **End Angle** field and enter the angle using the numeric keypad.

NOTE

- When Part Circle is enabled, you are creating a graphical representation of the pivot field. The control panel does NOT prevent the machine from running outside the designated zone. It also does NOT stop the machine at the start angle or end angle.
- An empty Part Circle check box indicates a full circle field.

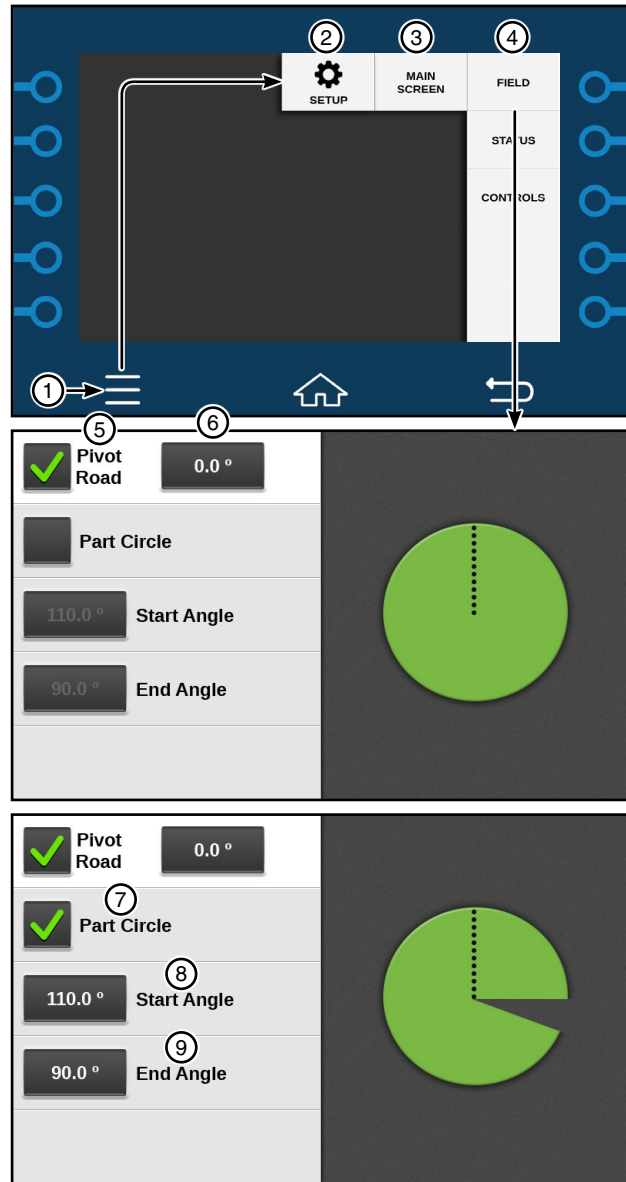

Figure 34-1 1. Menu 5. Pivot Road Checkbox
2. Setup 6. Pivot Road Position
3. Main Screen 7. Part Circle Checkbox
4. Field 8. Start Angle
9. End Angle

Main Screen Setup (continued)

Statuses

2. On the Status screen select up to four statuses that you want to appear on the Main Screen. The Status drop-down Menu number relates to the location of the status on the Main Screen. See Figure 35-1.
 - (a) Push **Menu**, **Setup**, **Main Screen** and **Status**.
 - (b) Select a drop-down menu and choose a status. Use the **Next** and **Previous** arrows to navigate through all available options. Choose Empty if you want to leave the field blank on the Main Screen.

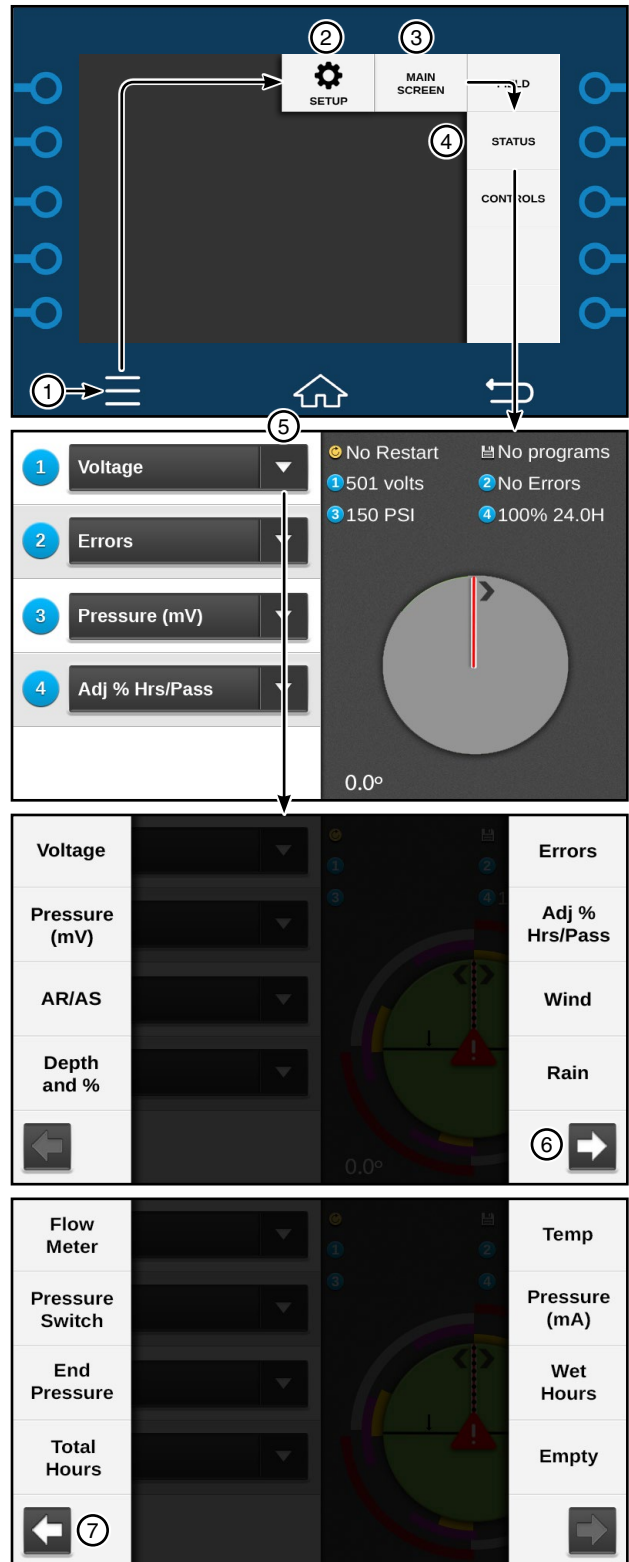

Figure 35-1 1. Menu 4. Status
 2. Setup 5. Drop-Down Menu
 3. Main Screen 6. Next
 7. Previous

Control Panel Setup

Main Screen Setup (continued)

Controls

3. On the Controls screen select up to five buttons that you want to appear on the Main Screen. The Controls drop-down Menu number relates to the location of the control on the Main Screen. See Figure 36-1.

- (a) Push **Menu**, **Setup**, **Main Screen** and **Controls**.
- (b) Select a drop-down menu and choose a control. Use the **Next** and **Previous** arrows to navigate through all available options. Choose Empty if you want to leave the field blank on the Main Screen.

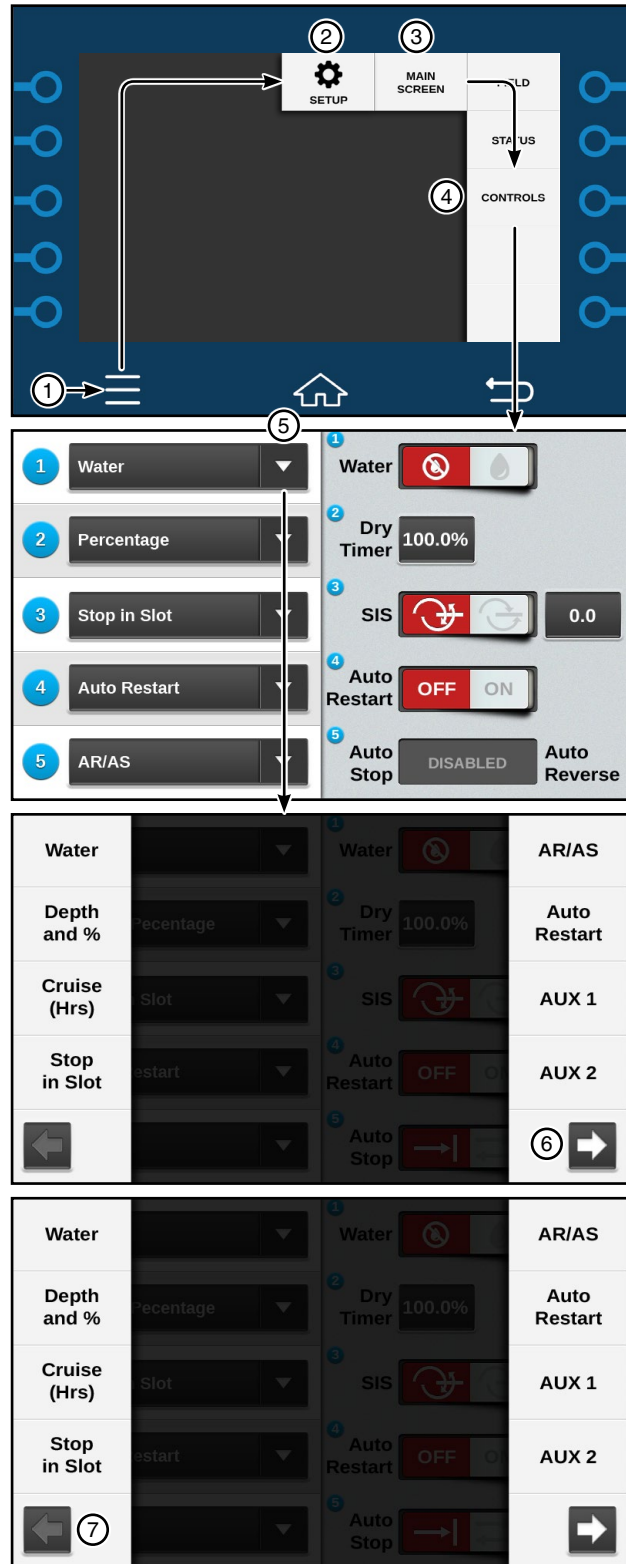

Figure 36-1 1. Menu 2. Setup 3. Main Screen 4. Controls 5. Drop-Down Menu 6. Next 7. Previous

Minimum Control Panel Setup

Set up the control panel for use by completing the Minimum Control Panel Setup. If desired, control panel settings can be recorded on the System Constants Record at the end of this section.

Reference tables are included in this section for Voltage, Low Voltage, Estimated Drive Speed and GPS Angular Conversion of minutes and seconds into decimal degrees.

Listed below are the reference table locations:

Voltage.....	page 49
Low Voltage.....	page 49
Estimated Drive Unit Speed Table.....	page 50
GPS Angular Conversion Table.....	page 50
Angular Degree Examples.....	page 51
Constants Record.....	page 52

To set up the control panel, do the following:

1. Go to the Constants screen to set the pivot minimum application, time per revolution, and voltage. See Figure 37-1.
 - (a) Push **Menu**, **Setup**, **Constants** and **System/Voltage**.
 - (b) Select the **Minimum Application** field and enter the rate on the numeric keypad. Refer to the VChart Report for this machine.
 - (c) Select the **Hours Per Revolution** field and enter the number on the keypad. Refer to the VChart Report for this machine.
 - (d) Select the **Low Voltage** field and enter the limit number on the keypad, if it's lower than 440 volts. Refer to Low Voltage on page 49 for more information.
 - (e) Push the **Calibrate** button and enter the actual voltage reading on the keypad. Refer to Voltage on page 49 for more information.

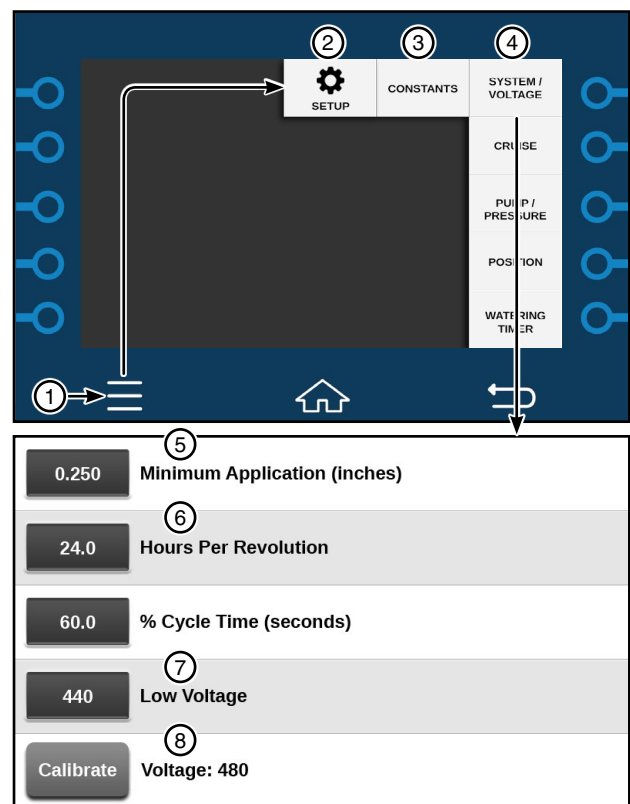

Figure 37-1

1. Menu	5. Minimum Application
2. Setup	6. Hours Per revolution
3. Constants	7. Low Voltage
4. System/Voltage	8. Calibrate

Control Panel Setup

Minimum Control Panel Setup (continued)

2. Go to the Pump screen to verify settings and associate pressure sensor(s) with the machine status. See Figure 38-1.

- (a) Push **Menu**, **Setup**, **Constants**, **Pump / Pressure** and **Pump Setup**.
- (b) Verify that the following are set to the required values.
 - (i) **Auto Restart Via**: To change, choose between Pressure, Power or Both.
 - (ii) **Pump Type** To change, choose between Engine Pump or Electric Pump.
 - (iii) **Low Pressure**: To change, select the Low Pressure field and enter the value on the numeric keypad.
 - (iv) **High Pressure**: To change, select the High Pressure field and enter the value on the numeric keypad.

- (c) Push **Back** and **Sensor Setup**.
- (d) Sensor Setup screen: Check the checkbox associated with the existing pressure sensor(s) that should be used for input when the machine is stopped and/or running.

In this example a Pressure (mA) Sensor and Valley GPS Pressure Sensor are used.

A minimum of two checkboxes must be checked, one for stopped input and one for running input.

NOTE

- If none of the boxes are checked the machine will run with Water on. If multiple sensors are checked for running, the machine will start after the first sensor reaches the low pressure limit. However if all sensors do not meet the low pressure limit before the pressure delay the machine will shut down.
- Valley GPS Pressure can be used as the only transducer on the system. It will be able to stop the pivot on pressure loss, but will not be able to do pressure restart.
- Valley GPS Pressure cannot be used to restart on water pressure. A transducer must be wired at the control panel and a "Stopped" transducer selected for this pressure restart.

CAUTION

- IF USING MORE THAN ONE PRESSURE SENSOR, WITH AUTORESTART VIA; SET TO EITHER PRESSURE OR BOTH, MAKE SURE THE PUMP HAS THE PROPER RESTART PROTECTION.

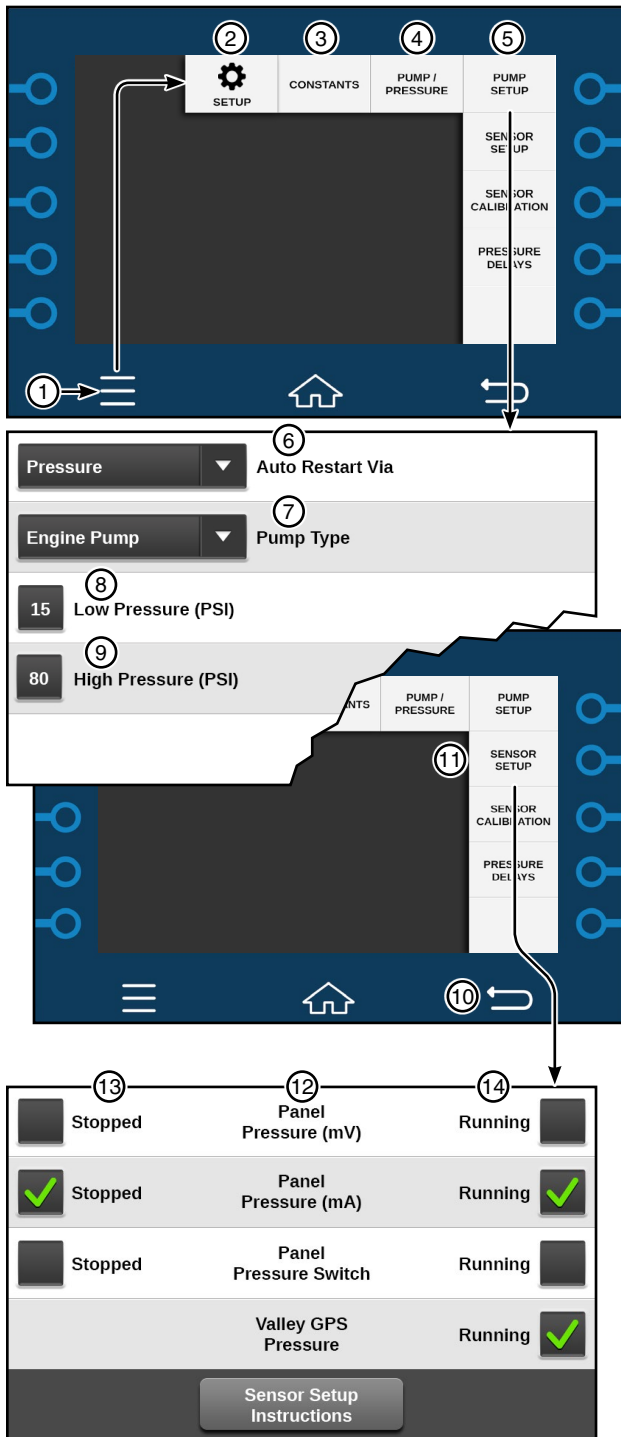

Figure 38-1 1. Menu 2. Setup 3. Constants 4. Pump / Pressure 5. Pump Setup 6. Auto Restart Via 7. Pump Type 8. Low Pressure 9. High Pressure 10. Back 11. Sensor Setup 12. Sensor Setup Screen 13. Stopped Inputs 14. Running Inputs

Minimum Control Panel Setup (continued)

3. Calibrate Pressure Sensors. See Figure 39-1.

(a) Push **Back** and **Sensor Calibration** to display the Pressure Sensor Setup screen.

(b) Verify that the **Max Pressure**, **Value at Max Pressure** and **Value at 0 Pressure** are set to the required values for the sensor(s) being used.

To change a value, select the value and enter a new value on the keypad.

(c) With the pump off and the machine dry, push the **Calibrate** button for the sensor being used.

(d) Push Yes to set the water pressure sensor to the current water pressure of zero.

(e) To access other pressure sensors, use the **Next** and Previous (not shown) arrows.

(f) Repeat steps (b) through (d) for other sensors.

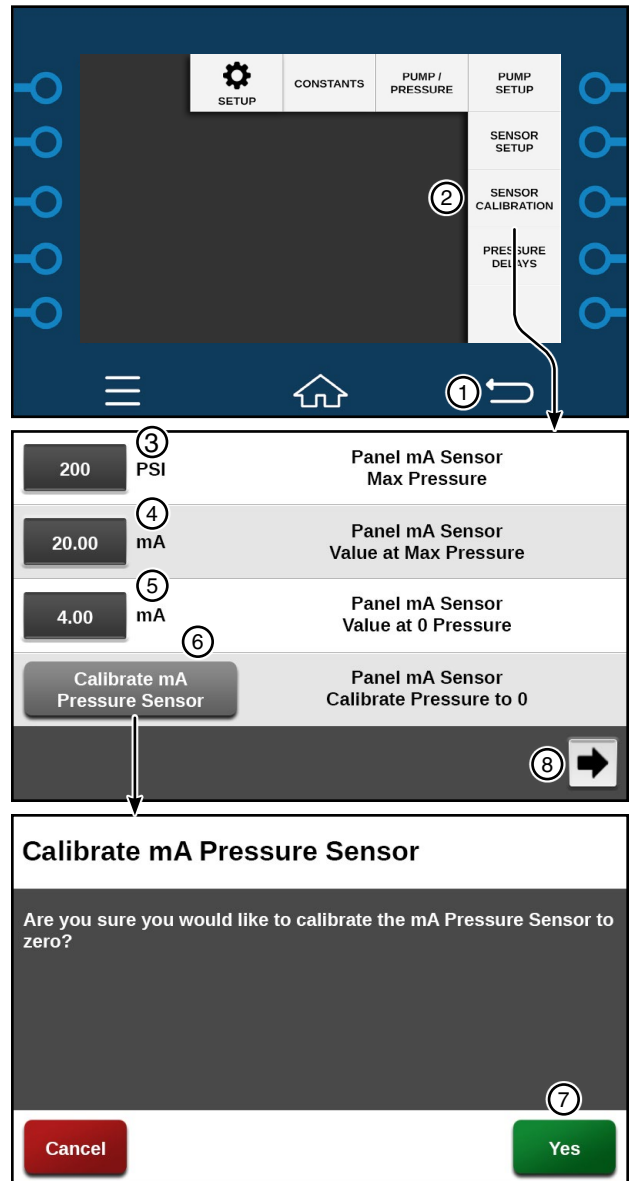

Figure 39-1

1. Back
2. Sensor Calibration
3. Sensor Max Pressure
4. Value at Max Pressure
5. Sensor Value at 0 Pressure
6. Calibrate Pressure Sensor to 0
7. Yes
8. Next

Control Panel Setup

Minimum Control Panel Setup (continued)

4. Program the position-related control panel settings based on how the machine is equipped:
 - If the machine is equipped with a **Position Encoder**, continue with **Set Up Position Encoder** on this page.
 - If the machine is equipped with **GPS Position**, continue with **Set GPS Position** on page 42.

Set Up Position Encoder

To setup the Position Encoder, do the following:

1. Set the RJ11 Communications Port protocol:
 - (a) Push **Menu**, **Setup**, **Comm Port** and **RJ11**.
 - (b) Select the **RJ11 Protocol** field and choose **Position Encoder** from the list. See Figure 40-1.

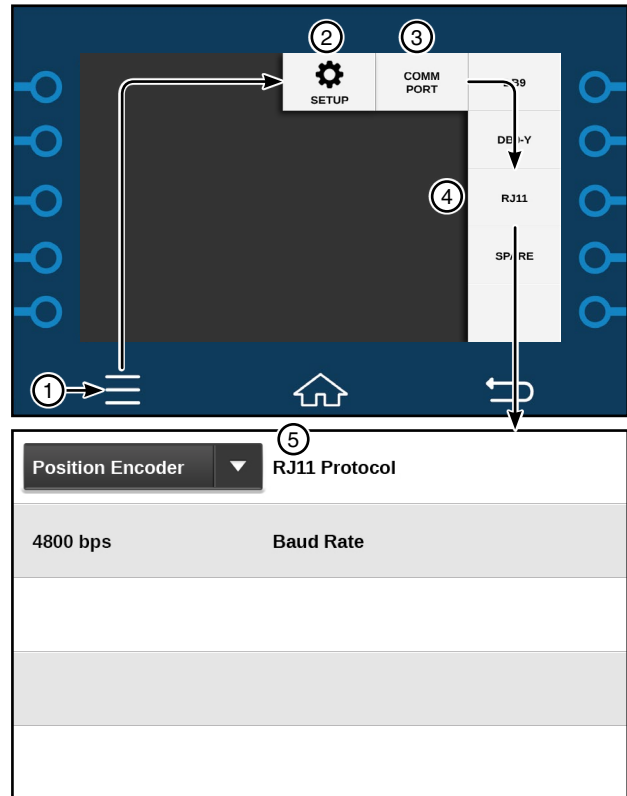

Figure 40-1 1. Menu 2. Setup 3. Comm Port 4. RJ11 5. RJ11 Protocol

Minimum Control Panel Setup (continued)

Set Up Position Encoder (continued)

- (c) Push **Menu**, **Setup**, **Constants**, and **Position** to display the Position screen.
- (d) Push the **Calibrate** button and enter the pivot position in degrees on the numeric keypad. See Figure 41-1.
- (e) Continue with Position Loss Setup on page 47.

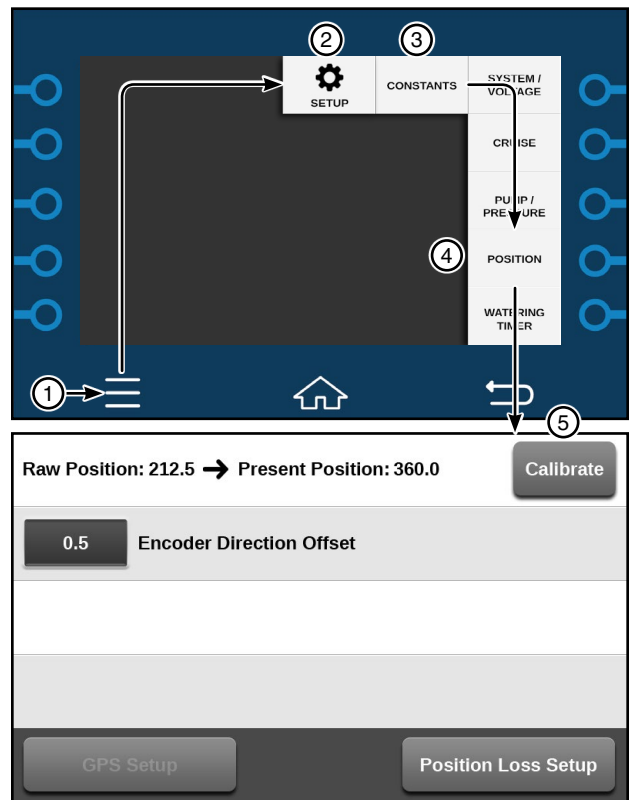

Figure 41-1 1. Menu 3. Constants
2. Setup 4. Position
5. Calibrate

Control Panel Setup

Minimum Control Panel Setup (continued)

Set Up GPS Position

(Machines equipped with GPS Pivot Position)

To setup GPS pivot position, do the following:

- Obtain the last tower speed and pivot length information from the VChart report for this machine or measure the span length from pivot to last regular drive unit, excluding the overhang, and use the Estimated Drive Unit Speed table on page 50.
 - Use a handheld GPS receiver to obtain the GPS coordinates for the Pivot Point position.
 - If necessary, use the GPS Angular Conversion table on page 50 to convert the GPS coordinate values into decimals of degree.
2. Set the RJ11 Communications Port protocol:
Push **Menu**, **Setup**, **Comm Port** and **RJ11**.

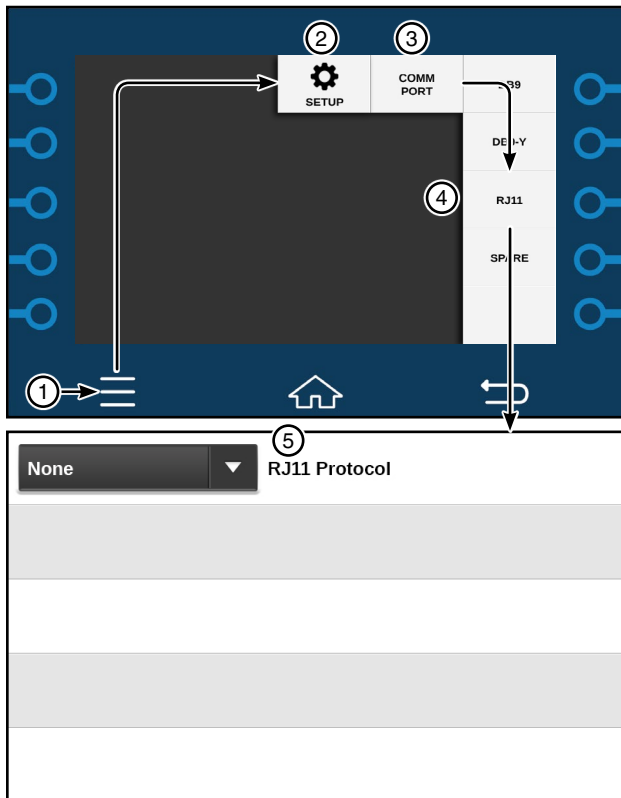

Figure 42-1 1. Menu 2. Setup 3. Comm Port 4. RJ11 5. RJ11 Protocol

Minimum Control Panel Setup (continued)

Set Up GPS Position(continued)

3. Select the **RJ11 Protocol** field and depending on which GPS position option is installed on the machine, choose either PLC (GPS Position Tower Box) or Valley GPS (Valley GPS Antenna) from the list. See Figures 43-1 and 43-2).

- **When PLC is chosen:**

- Check the **GPS V2** checkbox to enable position. See Figure 42-1.
- Enter the **PLC ID** for the GPS V2.
- Push the **Return** button. See Figure 42-2.
- Continue with step 4 on page 45.

- **When Valley GPS is chosen:**

- Turn Water off,
- Set the Dry % Timer to 0.0 (zero percent), and
- Push a **Start** button to start the machine, energize the safety circuit and the Valley GPS. The machine should not move.
- Select the **Valley GPS Device List** button.
- Continue with step (f) on the next page.

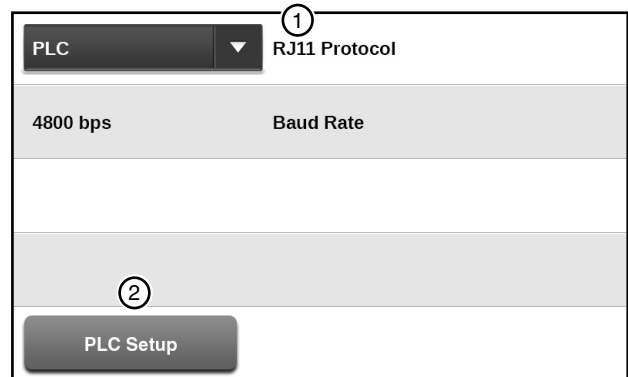

Figure 43-1 1. RJ11 Protocol 2. PLC Setup 3. GPS V2 4. Return

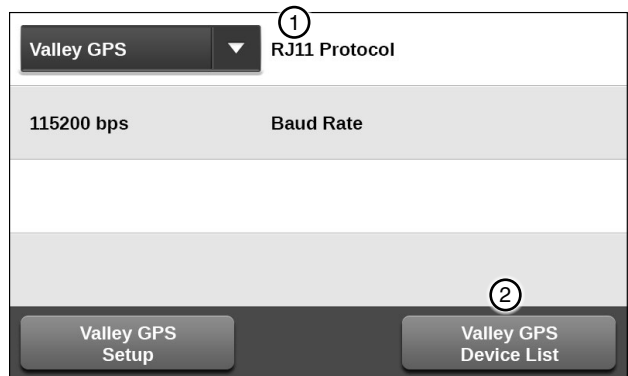

Figure 43-2 1. Valley GPS 2. Valley GPS Device List

Control Panel Setup

Minimum Control Panel Setup (continued)

Set Up GPS Position (continued)

- (f) Enter the **Number of Devices** Installed.
- (g) When only one Valley GPS is installed, enter 1.
- (h) When other Valley GPS or VRI options are installed, enter the total number of devices, up to 254.
- (i) Push the Discover Devices button. The control panel attempts to locate the devices.

NOTE

- The **Discover Devices** button must be pushed within four minutes of starting the machine.

- (j) Discovery of devices can typically take between three and six minutes.
- (k) After the device(s) have been discovered, note the PLC ID of the Valley GPS.
- (l) Click the **Return** button to close the Valley GPS Device List.
- (m) Continue with step 4 on the next page.

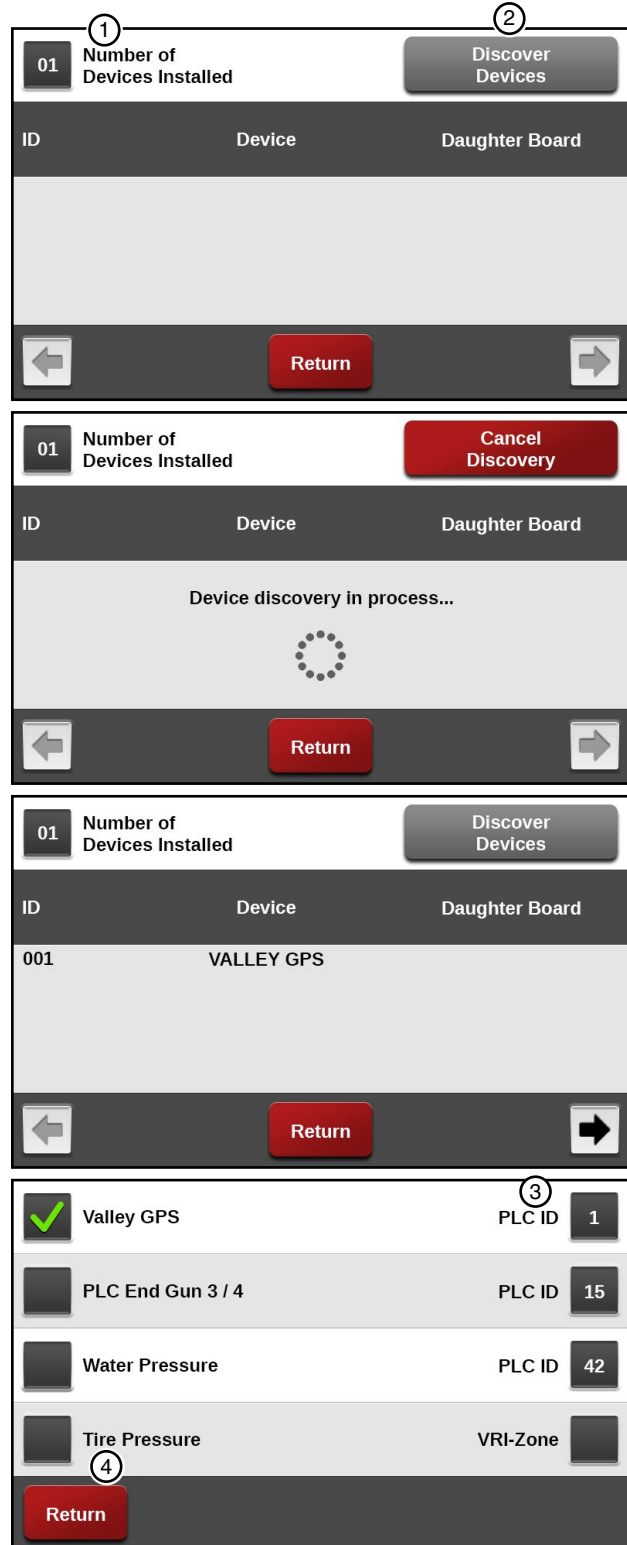

Figure 44-1 1. Number of Devices Installed 2. Discover Devices 3. PLC ID 4. Return

Minimum Control Panel Setup (continued)

Set Up GPS Position (continued)

- Go to the GPS Setup screen. See Figure 37-3.

Push **Menu**, **Setup**, **Constants**, **Position** and **GPS Setup** to display the GPS Setup screen.

NOTE

- Latitude and Longitude positions displayed on a handheld GPS receiver are usually displayed as North, South, East or West.
- The direction displayed affects how the position is entered into the control panel.
- If the position is shown as West or South the position **MUST** be entered as a Negative Degree.
- In North America, latitude positions are always positive, and longitude positions are always negative.

- Set the Pivot Point GPS position:
 - Select the **Pivot Point GPS Latitude** field and enter the pivot point latitude on the numeric keypad.
 - Select the **Pivot Point GPS Longitude** field and enter the pivot point longitude on the numeric keypad.

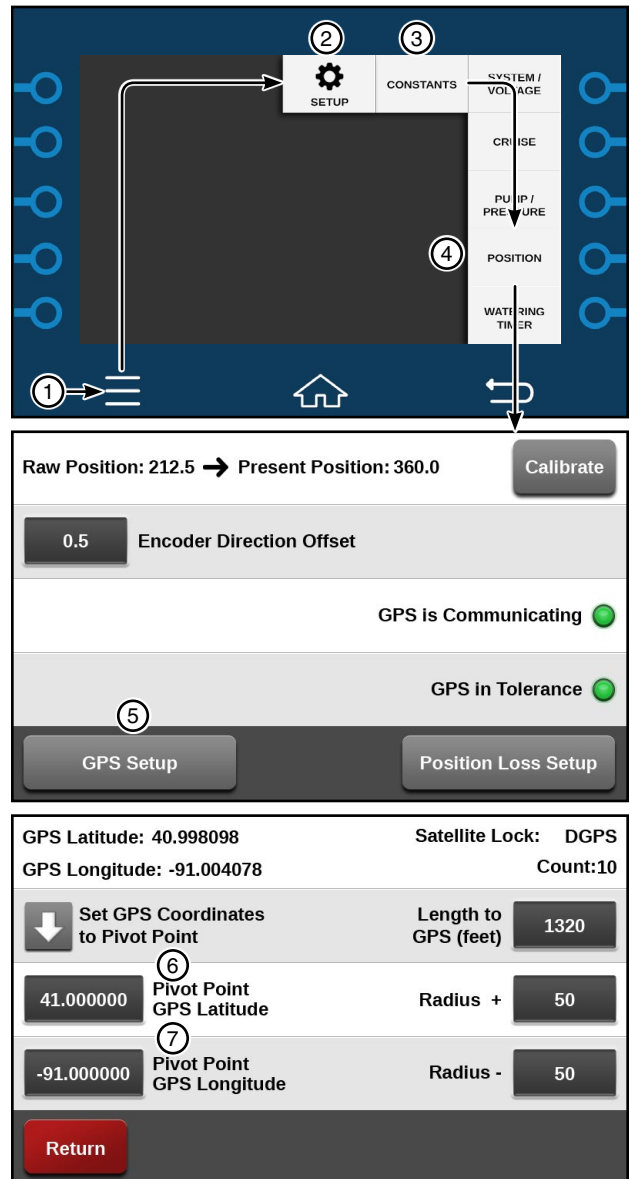

Figure 45-1 1. Menu 2. Setup 3. Constants 4. Position 5. GPS Setup 6. Pivot Point GPS Latitude 7. Pivot Point GPS Longitude

Control Panel Setup

Minimum Control Panel Setup (continued)

Set Up GPS Position (continued)

6. Set the Distance to GPS (the distance from pivot point to GPS tower box) including the plus and minus tolerance. Refer to Figure 46-1.
 - (a) Select the **Length to GPS (feet)** field and enter the length from the pivot point to the GPS tower box. Do not enter the pivot length. The default is 1320 ft (402.3 m), and the range is 10 to 6554 ft (3.0 to 1997.6 m).
 - (b) Select the **Radius +** field and enter the Plus Tolerance for the length from pivot point to GPS tower box. The Default is 50 ft (15.2 m) and the range is 10 to 6554 ft (3.0 to 1997.6 m). A setting of 50 ft (15.2 m) or more is recommended to allow for variation in the GPS signal if Wide Area Application Services (WAAS) is unavailable.
 - (c) Select the **Radius -** field and enter the Minus tolerance for the length from pivot point to GPS tower box. The Default is 50 ft (15.2 m) and the range is 10 to 6554 ft (3.0 to 1997.6 m). A setting of 50 ft (15.2 m) or more is recommended to allow for variation in the GPS signal if WAAS is unavailable.
 - (d) Continue with Set Up Position Loss on the next page.

GPS Latitude: 40.998098	Satellite Lock: DGPS
GPS Longitude: -91.004078	Count:10
 Set GPS Coordinates to Pivot Point	Length to GPS (feet) <input type="text" value="1320"/>
<input type="text" value="41.000000"/> Pivot Point GPS Latitude	Radius + <input type="text" value="50"/>
<input type="text" value="-91.000000"/> Pivot Point GPS Longitude	Radius - <input type="text" value="50"/>
<input type="button" value="Return"/>	

Figure 46-1 1. Number of Devices Installed 3. PLC ID
2. Discover Devices 4. Return

Minimum Control Panel Setup (continued)

Set Up Position Loss

In the event of Position Loss, three different position loss functions can be used independently, or with each other, to control the machine operation. To access these functions, push **Menu**, **Setup**, **Constants**, **Position** and **Position Loss Setup**.

- **System Shutdown:** When checked, shuts the system down if the position is lost for a specified period of time. The default setting is checked (enabled) with a 20-minute delay.
- **Disable Endguns:** When checked, disables the end guns if the position is lost for a specified period of time. The default setting is unchecked (disabled) with a 10-minute delay.
- **Fallback Position:** When checked, if the position is lost, the position is calculated using Runtime until the position is re-acquired. The default setting is checked (enabled) with Runtime.

System Shutdown

To set up a shutdown of the system, do the following:

1. Check the **System Shutdown** checkbox. See Figure 47-1.
2. Select the System Shutdown **Delay Time** field and enter the number of minutes (1 to 255) on the numeric keypad. The default is 20 minutes.

Disable Endguns

To set up the disabling of end guns, do the following:

1. Check the **Disable Endguns** checkbox. See Figure 47-1.
2. Select the Disable Endguns **Delay Time** field and enter the number of minutes (1 to 255) on the numeric keypad. The default is 10 minutes.

Runtime Fallback Position

To set up the fallback position, do the following:

1. Check the **Runtime Fallback Position** checkbox. See Figure 47-1.
2. Select the **LRDU Pivot Speed** field and enter the speed on the numeric keypad. The default is 15.56 ft/min.
3. Select the **Pivot Length** field and enter the length on the numeric keypad. The default is 1320 ft (402.3 m).

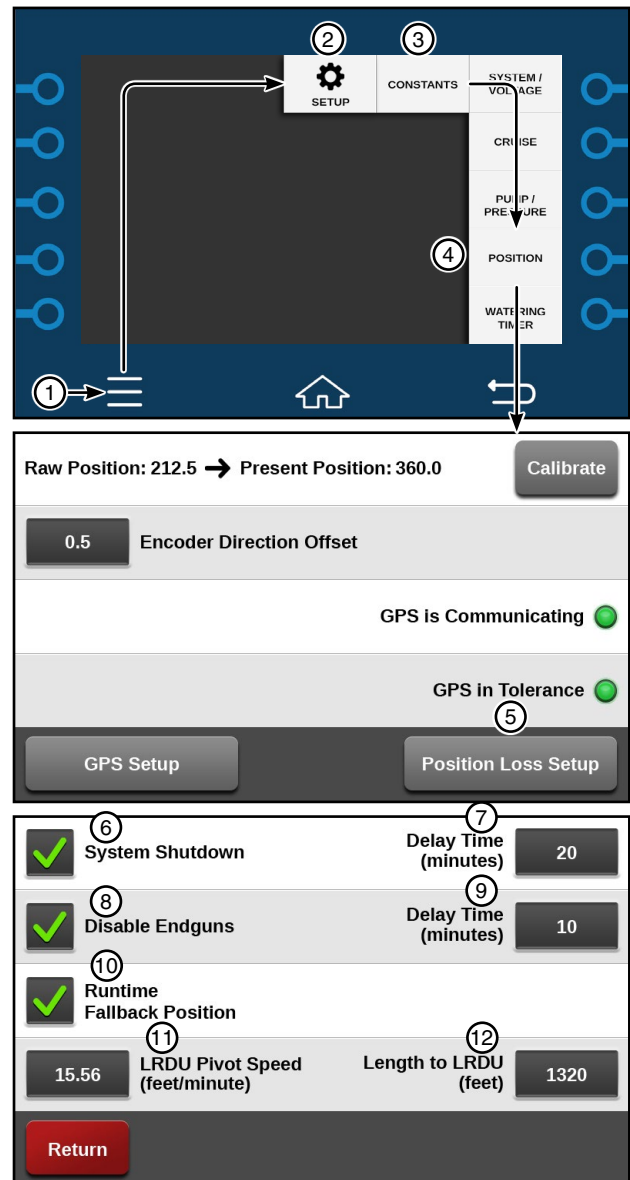

Figure 47-1

1. Menu	7. System Shutdown Delay
2. Setup	8. Disable End Guns
3. Constants	9. Disable End Guns Delay
4. Position	10. Fallback Position
5. Position Loss	11. LRDU Pivot Speed
6. System Shutdown	12. Length to LRDU

Control Panel Setup

Minimum Control Panel Setup (continued)

Test GPS Position

If the machine is equipped with GPS Position, do the following to verify that GPS Position is working.

1. Turn **Water** off, Set the **Dry % Timer** to 0.0 (zero percent), and push a **Start** button to start the machine, energize the safety circuit and the GPS pivot position tower box. The machine should not move.
2. Go to the Position screen. Push **Menu**, **Setup**, **Constants** and **Position**.
3. When GPS Position is working, the **GPS is Communicating** and the **GPS in Tolerance** lights will both be green indicating proper operation.
 - If the GPS is Communicating light is off (gray):
 - » Valley GPS takes 1 minute before acquiring its position.
 - » No connections have been established with one or more satellite(s).
 - » No communications from the GPS antenna and the control panel.
 - » Call your Valley dealer to diagnose the problem.
 - If the GPS in Tolerance light is off (gray) and/ or the Present Position value is flashing, verify that the Length to GPS, Radius +, and Radius - values are correct on the GPS Setup screen.
4. Set the Present Position of the pivot span in degrees.
 - (a) Push **Calibrate**.
 - (b) Enter the pivot span position in degrees and push **Enter**.
5. To view the GPS Setup screen push **GPS Setup**. See Figure 48-1.
 - Satellite Lock – verify that there is DGPS lock. If it's not, continue waiting. Depending on location it can take 15 minutes or longer for the GPS Antenna to lock on to the satellite signal and obtain DGPS accuracy. When GPS Position is lost or not found, the word **NONE**, or **No GPS** is displayed in the Satellite Lock field.
 - Length to GPS, Radius + and Radius - verify values are correct.
 - If GPS position is not working, call your local Valley Dealer. If it is working, then continue with the next step.
6. Run the machine in either direction to verify that the position displayed on the Status screen GPS Longitude changes periodically as the machine moves.
 - If GPS position is not working, call your local Valley Dealer. If GPS position is working, the minimum control panel setup for a machine with GPS pivot position is complete.

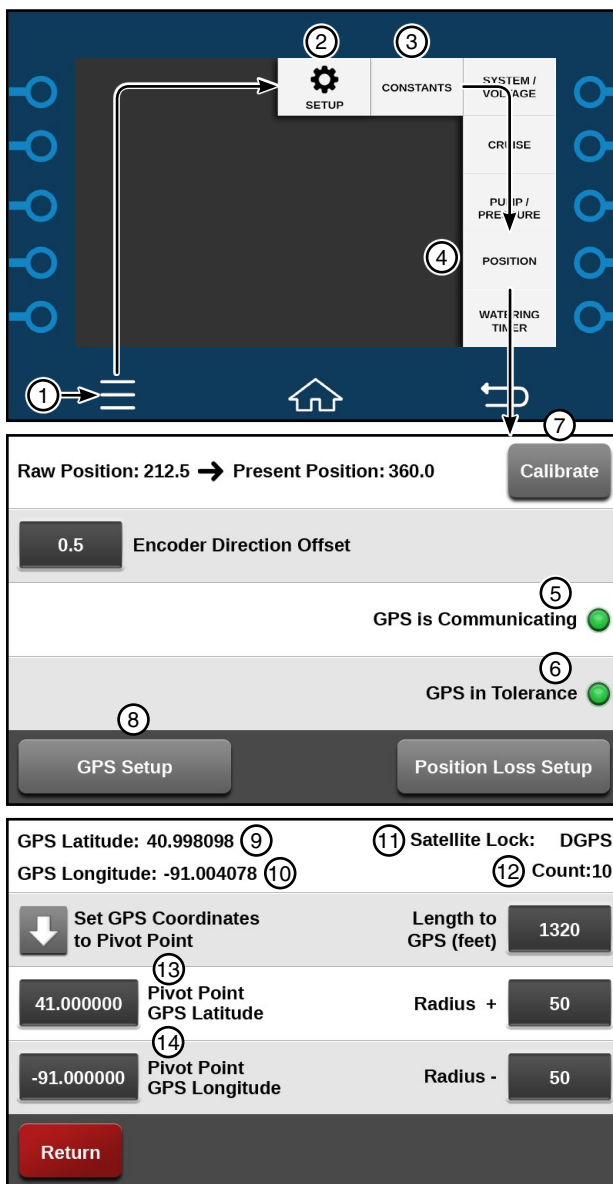

Figure 48-1

1. Menu	8. GPS Setup
2. Setup	9. GPS Latitude'
3. Constants	10. GPS Longitude
4. Position	11. Satellite Lock
5. GPS is Communicating	12. Count
6. GPS in Tolerance	13. Pivot Point Latitude
7. Calibrate Button	14. Pivot Point Longitude

Voltage

The Voltage constant calibrates the volt meter with the actual voltage coming into the control panel so that the voltage fluctuations can be monitored correctly.

The incoming voltage to the control panel must be measured with a meter by a qualified electrician or service person. This value is entered as the voltage constant.

The supply voltage should never exceed the limits shown in the Maximum Supply Voltage chart. Refer to Figure 49-1.

Nominal Supply Voltage	Maximum Supply Voltage
480 VAC @ 60Hz	505 VAC
415 VAC @ 50Hz	420 VAC
400 VAC @ 50Hz	420 VAC
380 VAC @ 50Hz	420 VAC
230 VAC @ 60Hz	253 VAC
220 VAC @ 50Hz	243 VAC

Figure 49-1 Maximum Supply Voltage

Low Voltage

The Low Voltage constant is used to set the low voltage limit. The low voltage limit factory default setting is 440 volts for use with a supply voltage of 480 VAC @ 60Hz. Recommended low voltage limits for other supply voltages are shown in the Recommended Low Voltage chart. Refer to Figure 49-2.

- If the voltage drops below the low voltage limit, a built-in timer keeps the machine running for up to 15 seconds to prevent nuisance shutdowns due to voltage fluctuations. If the low voltage condition still exists after 15 seconds, the machine will be shut down and the diagnostics screen will display a fault for machine power.
- If the voltage drops below half the low voltage limit for 3 seconds or more while the machine was waiting/running with water on or more than 1 second if running with water off, the machine will be shut down and the diagnostics screen will display a fault for machine power.

Nominal Supply Voltage	Recommended Low Voltage Setting
480 VAC @ 60Hz	440 VAC
415 VAC @ 50Hz	375 VAC
400 VAC @ 50Hz	365 VAC
380 VAC @ 50Hz	355 VAC
230 VAC @ 60Hz	220 VAC
220 VAC @ 50Hz	210 VAC

Figure 49-2 Recommended Low Voltage

CAUTION

- DO NOT SET LOW VOLTAGE LOWER THAN THE RECOMMENDED LOW VOLTAGE LIMIT.
- LOW VOLTAGE WILL DAMAGE THE DRIVE MOTORS AND OTHER ELECTRICAL COMPONENTS. CORRECT THE PROBLEM BEFORE RESUMING OPERATION.

Control Panel Setup

Estimated Drive Unit Speed Tables

Use these tables to estimate the Intermediate Drive Unit and End Drive Unit speed based on the drive unit motor output RPM, tire size, and machine voltage. Refer to Figure 50-1.

Estimated Drive Unit Travel Speed Feet/Minute (60 Hz)**

Motor Output 60 Hz	Tire Size										
	10R X 22.5	11.2 X 24	11R X 22.5	11R X 24.5	14.9 X 24 Non Directional	14.9 X 24 or Turf	16.9 X 24 or Turf	18.4 X 26 or Turf	11.2 X 38 or Non Directional	12.4R X 38	Valley Revolution
	Feet/Minute										
30	5.91	6.11	6.33	6.33	6.95	7.28	7.74	8.17	8.34	8.46	6.96
34	6.70	6.92	7.18	7.18	7.88	8.25	8.77	9.26	9.45	9.59	7.89
37	7.29	7.53	7.81	7.81	8.57	8.98	9.55	10.08	10.28	10.44	8.58
43	8.48	8.75	9.08	9.08	9.96	10.43	11.09	11.71	11.95	12.13	9.97
56	11.04	11.40	11.82	11.82	12.98	13.59	14.45	15.26	15.56	15.79	12.99
68	13.40	13.84	14.36	14.36	15.76	16.50	17.54	18.53	18.90	19.18	15.77
86	16.95	17.50	18.16	18.16	19.93	20.87	22.19	23.43	23.90	24.26	19.95
100	19.71	20.35	21.12	21.12	23.17	24.26	25.80	27.24	27.79	28.21	23.19
136	26.81	27.68	28.72	28.72	31.52	33.00	35.09	37.05	37.80	38.36	31.54

Estimated Drive Unit Travel Speed Feet/Minute (50 Hz)**

Motor Output 50 Hz	Tire Size										
	10R X 22.5	11.2 X 24	11R X 22.5	11R X 24.5	14.9 X 24 Non Directional	14.9 X 24 or Turf	16.9 X 24 or Turf	18.4 X 26 or Turf	11.2 X 38 or Non Directional	12.4R X 38	Valley Revolution
	Feet/Minute										
25	4.93	5.09	5.28	5.28	5.79	6.07	6.45	6.81	6.95	7.05	5.80
28	5.58	5.77	5.98	5.98	6.57	6.87	7.31	7.72	7.87	7.99	6.57
31	6.08	6.28	6.51	6.51	7.15	7.48	7.96	8.40	8.57	8.70	7.15
36	7.06	7.29	7.57	7.57	8.30	8.69	9.25	9.76	9.96	10.11	8.31
47	9.20	9.50	9.85	9.85	10.81	11.32	12.04	12.71	12.97	13.16	10.82
57	11.17	11.53	11.97	11.97	13.13	13.75	14.62	15.44	15.75	15.98	13.14
72	14.13	14.59	15.13	15.13	16.61	17.39	18.49	19.52	19.92	20.21	16.62
83	16.43	16.96	17.60	17.60	19.31	20.22	21.50	22.70	23.16	23.50	19.33
136	26.81	27.68	28.72	28.72	31.52	33.00	35.09	37.05	37.80	38.36	31.54

$$\text{Drive Unit Speed(ft/min)} = \frac{(\text{Tire rolling Circumference} \times \text{Motor Speed(rpm)})}{(\text{Gearbox Reduction}(52) \times 12)}$$

**These speeds are estimates only. Actual speeds will vary according to inflation pressure and field conditions. Machine speed should be measured after installation to determine the actual performance.

Figure 50-1 Estimated Drive Unit Speed Tables

GPS Angular Conversion Table

Use the GPS Angular Conversion table to convert the GPS angular degrees from minutes and seconds to decimal degrees when manually setting up the GPS coordinates in the control panel. Refer to Figure 51-1.

Minutes and Seconds into Decimals of a Degree

(Based on 1 second = 0.00027778 degrees)

Minutes into Decimals of a Degree						Seconds into Decimals of a Degree					
Min.	Deg.	Min.	Deg.	Min.	Deg.	Sec.	Deg.	Sec.	Deg.	Sec.	Deg.
1	0.0167	21	0.3500	41	0.6833	1	0.0003	21	0.0058	41	0.0114
2	0.0333	22	0.3667	42	0.7000	2	0.0006	22	0.0061	42	0.0117
3	0.0500	23	0.3833	43	0.7167	3	0.0008	23	0.0064	43	0.0119
4	0.0667	24	0.4000	44	0.7333	4	0.0011	24	0.0067	44	0.0122
5	0.0833	25	0.4167	45	0.7500	5	0.0014	25	0.0069	45	0.0125
6	0.1000	26	0.4333	46	0.7667	6	0.0017	26	0.0072	46	0.0128
7	0.1167	27	0.4500	47	0.7833	7	0.0019	27	0.0075	47	0.0131
8	0.1333	28	0.4667	48	0.8000	8	0.0022	28	0.0078	48	0.0133
9	0.1500	29	0.4833	49	0.8167	9	0.0025	29	0.0081	49	0.0136
10	0.1667	30	0.5000	50	0.8333	10	0.0028	30	0.0083	50	0.0139
11	0.1833	31	0.5167	51	0.8500	11	0.0031	31	0.0086	51	0.0142
12	0.2000	32	0.5333	52	0.8667	12	0.0033	32	0.0089	52	0.0144
13	0.2167	33	0.5500	53	0.8833	13	0.0036	33	0.0092	53	0.0147
14	0.2333	34	0.5667	54	0.9000	14	0.0039	34	0.0094	54	0.0150
15	0.2500	35	0.5833	55	0.9167	15	0.0042	35	0.0097	55	0.0153
16	0.2667	36	0.6000	56	0.9333	16	0.0044	36	0.0100	56	0.0156
17	0.2833	37	0.6167	57	0.9500	17	0.0047	37	0.0103	57	0.0158
18	0.3000	38	0.6333	58	0.9667	18	0.0050	38	0.0106	58	0.0161
19	0.3167	39	0.6500	59	0.9833	19	0.0053	39	0.0108	59	0.0164
20	0.3333	40	0.6667	60	1.0000	20	0.0056	40	0.0111	60	0.0167

Figure 51-1 GPS Angular Conversion Table

Angular Degree Examples

An angular degree in degrees, minutes, seconds will look like the following examples:

- **10° 11' 37", reads as 10 degrees, 11 minutes, 37 seconds.**
 - (a) Convert minutes and seconds to a decimal degree value using the table in Figure 51-1.
 - 11 minutes = 0.1833 degrees
 - 37 seconds = 0.0103 degrees
 - (b) Add all decimal degree values together.
 - 10 degrees = 10.0000 degrees
 - 11 minutes = 0.1833 degrees
 - 37 seconds = 0.0103 degrees
 - 10° 11' 37" = 10.1936 degrees**
- **12° 5.245', read as 12 degrees, 5.245 minutes.**
 - (a) Convert decimals of a minute to decimal degrees using the table in 51-1 and multiply the decimal of a minute by 0.0167.
 - 5 minutes = 0.0833 degrees
 - 0.245 minutes =
 - 0.245 × 0.0167 = 0.0041 degrees
 - (b) Add all decimal degree values together.
 - 12 degrees = 12.0000 degrees
 - 5 minutes = 0.0833 degrees
 - 0.245 minutes = 0.0041 degrees
 - 12° 5.245' = 12.0874 degrees**

Control Panel Setup

Constants Record

If desired, fill in the form below with the applicable constants for this machine.

RTU ID	
Stop In Slot Position	

Menu/End Guns

End Gun 1

Angle Pair	Left Angle	Right Angle
1		
2		
3		
4		
5		
6		
7		
8		
9		

End Gun 2

Angle Pair	Left Angle	Right Angle
1		
2		
3		
4		
5		
6		
7		
8		
9		

End Gun 3

Angle Pair	Left Angle	Right Angle
1		
2		
3		
4		
5		
6		
7		
8		
9		

End Gun 4

Angle Pair	Left Angle	Right Angle
1		
2		
3		
4		
5		
6		
7		
8		
9		

Setup/Main Screen

Field	
Pivot Road Enable	
Pivot Road Angle	
Part Circle Enable	
Start Angle	
End Angle	

Constants Record (continued)

Setup/Constants	
System	
Minimum application	
Hours per revolution	
% Cycle Time	
Low Voltage	
Current Voltage	
Pump / Pressure	
Auto Restart	
Power	
Pressure	
Both	
Pump Type	
Engine Pump	
Electric Pump	
Low Pressure	
High Pressure	
Pressure Delays Setup	
Startup Pressure delay	
Operating Pressure Delay	
High Pressure Delay	
Watering Timer	
Watering Timer Enable	
Overwater	
Run Timer Shutdown Time	
Overwater Shutdown %	
Underwater	
5 Degree Run Timer Error Time	
Underwater Error %	

Cruise	
% Change of Speed	
Field Size	
Resolution	
Position	
Encoder Direction Offset	
GPS Pivot Point	
Latitude	
Latitude	
Length to GPS	
Radius +	
Radius -	
GPS Signal Loss	
System Shutdown Enable	
Delay Time	
Disable End guns Enable	
Delay Time	
Runtime Fallback Position Enable	
LRDU Pivot speed	
Length to LRDU	

Control Panel Setup

Constants Record (continued)

Setup/Comm Port		
Comm Port	Protocol	Baud Rate
DB9		
DB9-Y		
RJ11		
Spare		
Protocol Constants		
VCP		
Baud Rate		
Flow Control		
High Speed		
Key Wait		
RTU ID		
VDC		
Baud Rate		
PLC		
GPS V2 Enable		
PLC ID		
End Guns 3 / 4 Enable		
PLC ID		
Water Pressure Enable		
Tire Pressure Enable		
VRI-Zone Enable		
Position Encoder		
Baud Rate		
VRI-iS		
Baud Rate		
Valley GPS		
Valley GPS Enable		
PLC ID		
End Guns 3 / 4 Enable		
PLC ID		
Water Pressure Enable		
Tire Pressure Enable		
VRI-Zone Enable		

System/Data	
Flow Hours	
Flow Multiplier	
Low Flow Limit Enable	
Low Flow Limit	
Battery Backup	
Battery Backup Enable	
Keep Awake Time	
Utilities	
AR/AS	
Auto Reverse/Auto Stop Enable	
Delay	
Forward/Reverse Position Enable	
Change Direction to Forward	
Change Direction to Reverse	
Weather	
Current Weather	
Wind Shutdown Enable	
MPH/KPH	
Temp shutdown Enable	
Degrees	
Rain Shutdown Enable	
In / mm	
Weather Constants	
Temperature Coefficient	
Temperature Offset	
Rain Window	
Rain Coefficient	

Constants Record (continued)

Utilities (continued)	
Notice	
Notice Enable	
Shutdown Event Enable	
History Event Enable	
Warning event Enable	
Base ID	
Call Out Tries	
Comm Port	
Radio Setup	
Radio Hop Enable	
Number of Hops	
Radio Hop ID	
Radio Hop ID	
Radio Hop ID	
TPMS	
TPMS Constants	
TPMS Shutdown Enable	
Below Nominal Warning Pressure	
Below Nominal Shutdown Pressure	

Programs	
Daily OPS	
Daily OPS Enable	
Mode	
Daily OPS	
Load Management	
Days	
Start Time	
Stop time	
Minimum application	
Cycles	
Start\$ Interval	
Start Time	
Restart in Days	
Start\$ Interval Enable	
SIS Bypass	
Number of Times to Bypass SIS	
VRI	
VRI-S Enable	
VRI-Z Enable	
VRI-Z Constants	
Valve Resync Pressure	
Number of Sprinkler Banks	
Min Cycle Time	
Speed Optimization Enable	
VRI-iS Enable	
VRI-iS Constants	
Valve Resync Pressure	
Min Cycle Time	
Max Cycle Time	
Number of Sprinklers	
Last Sprinkler Position	
Sprinkler Spacing	
Speed Optimization Enable	

Operation

Before Running the Machine

- ALWAYS make sure that vehicles, other equipment, livestock, and people are clear of the machine before operating.
- Turn the control panel main disconnect switch to the on position. If the power is supplied by an engine driven generator, set generator to proper voltage/Hz. Do not exceed system specifications.

Run The Machine Wet (With Water)







1. Push the **Water** button on the Main Screen to turn the water on. Refer to Figure 56-1.
2. To set the water application, select either the **Depth** field or **Wet % Timer** field.
 - In the Depth field, set the water application depth by inches or millimeters.
 - In the Wet % Timer field, adjust the percent to obtain the desired water application depth.
- (c) Enter either the depth or percent timer setting.
- (d) Push **ENTER** to retain the value.
5. Do one of the following:
 - Push  button to start the machine in the forward direction.
 - Push  button to start the machine in the reverse direction.
 - Push  to stop the machine.



Figure 56-1 1. Water On 2. Depth 3. Wet % Timer 4. Start Forward 5. Start Reverse 6. Stop

Run The Machine Dry (Without Water)

1. Push the **Water** button on the Main Screen to turn the water off. Refer to Figure 56-2.
2. To set the speed of travel, select the Dry % Timer field.
 - In the Dry % Timer field, adjust the percent to obtain the desired speed of travel.
- (c) Enter the percent timer setting.
- (d) Push **ENTER** to retain the value.
5. Do one of the following:
 - Push  button to start the machine in the forward direction.
 - Push  button to start the machine in the reverse direction.
 - Push  to stop the machine.

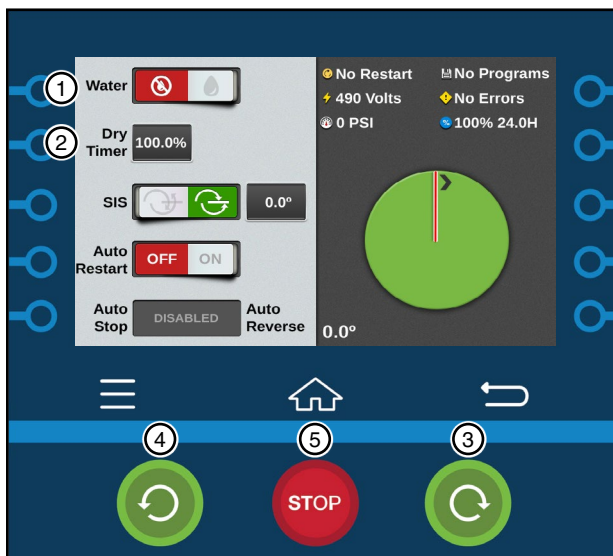

Figure 56-2 1. Water Off 2. Dry % Timer 3. Start Forward 4. Start Reverse 5. Stop

Stopping The Machine Emergency Stopping

To stop the machine in an emergency situation, shut off any one of the following. See Figure 57-1.

- Main Service Disconnect Switch from public power to the control panel (Item 1).
- Control Panel Main Disconnect Switch (Item 2).
- Any Tower Box Disconnect Switch (Item 3).

NOTE

- The machine has a time delay that prevents it from restarting when you press a start button within five seconds after stopping the machine with water on.

ICON5

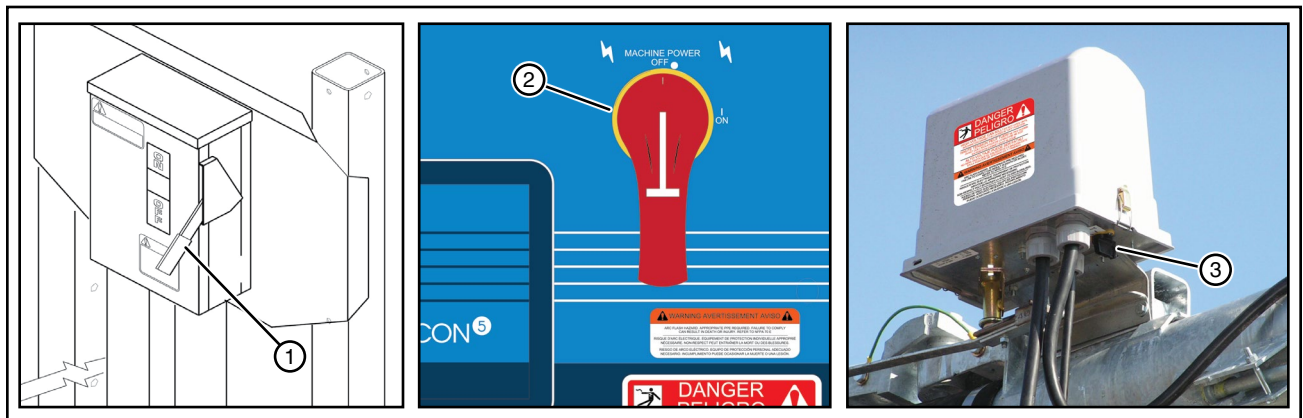

ICONX

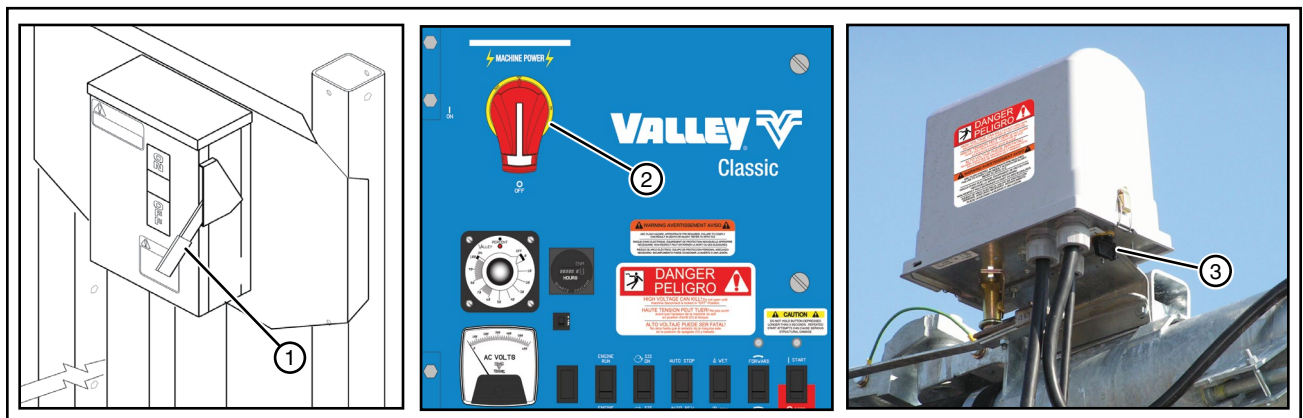

Figure 57-1 1. Main Service Disconnect Switch 2. Control Panel Main Disconnect Switch
3. Tower Box Disconnect Switch

Operation

Stopping The Machine (continued)

Stopping Under Normal Conditions

To stop the machine under normal conditions, refer to Figure 58-1 and do the following:

1. Push the Stop button.
2. Turn the Main Disconnect Switch to the off position.
3. Turn the pumping unit off (if not automatic).
4. If an engine generator set is used, move the Engine Run/Start switch to the Start position for the next start-up sequence.

⚠ WARNING

- **DO NOT SHUT THE MACHINE OFF BY SLOWLY IDLING DOWN THE ENGINE GENERATOR SET. THIS PRACTICE CAUSES LOW VOLTAGE AND WILL DAMAGE MACHINE COMPONENTS.**
- **ALWAYS STOP THE IRRIGATION MACHINE PRIOR TO SHUTTING DOWN THE ENGINE GENERATOR SET.**

ICON5

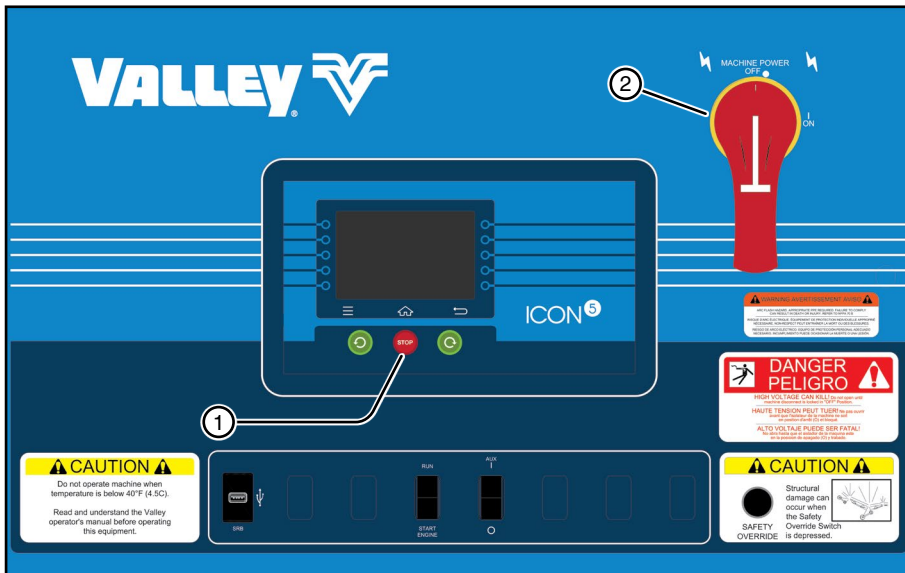

ICONX

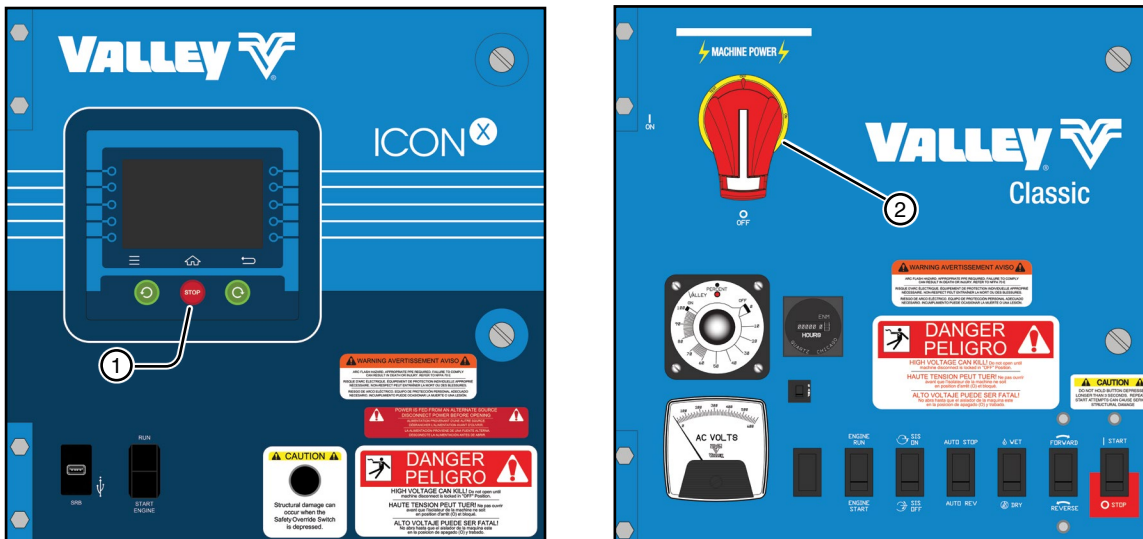

Figure 58-1 1. Stop Button 2. Control Panel Main Disconnect Switch

The Diagnostics section provides an overview of using the diagnostic features incorporated into the control panel. Diagnostics aid in identifying machine failures, troubleshooting and correcting problems.

System Stops and Faults

System Stops are recognized system or user commanded actions that cause the machine to shutdown. System Faults are failures that shut the machine down.

When a recognized fault or stop causes the machine to shut down, the Fault Notice icon is displayed on the pivot graphic and the item responsible for the shut down is displayed on the System Faults screen. See Figure 59-1.

The System Faults screen displays the current system stopped, system fault or no faults condition. The item causing the fault is shown at the bottom of the screen.

A list of all system stopped conditions and system faults are shown on the next page.

To view the current System Stop or System Fault do one of the following:

- Push **Menu, System, Diagnostics** and **System Faults**.
- Push the **Fault Notice** icon that appears on the pivot graphic.
- Push **Menu** and **Faults**.

Clearing Faults

The fault and fault notice icon are automatically cleared from the main screen the next time the machine runs successfully.

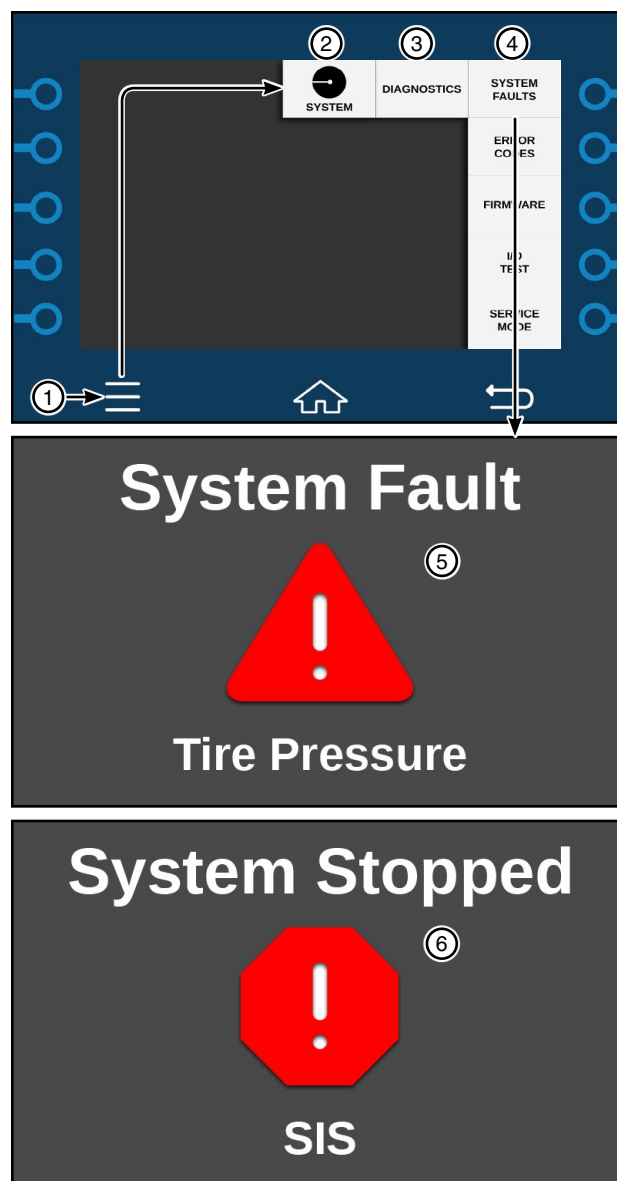

Figure 59-1 1. Menu 2. System 3. Diagnostics 4. System Faults 5. System Fault 6. System Stopped

Diagnostics

System Stops and Faults (continued)

The stops and faults that can be indicated on the System Fault screen are shown in Figures 60-1 and 61-1. Refer to System Stops and Faults on page 72 in the Troubleshooting section for possible causes and corrective actions.

System Stop Descriptions



System Stop	Description
Command	The machine was commanded to stop by pressing the STOP button.
Stop-In-Slot (SIS)	The machine was stopped by the Stop-In-Slot feature.
Daily Ops	The daily operations sequence was completed.
Program	A Step or Sector Program stopped the machine.
Auto-Stop	The Auto Stop boundary was reached.

Figure 60-1

System Stops and Faults (continued)

System Fault Descriptions



System Fault	Description
System Power Lost	Machine Power is lost.
System Power Low	Machine power is too low.
System Safety	Machine safety is not sensed.
Low Pressure	Water Pressure is too low.
High Pressure	Water pressure is too high.
NVMEM	E01 error is active.
Forward/Reverse	Both the forward and reverse circuits are energized.
Operating Sector	The machine position is not within operating sector.
Wind	The wind speed is too high. Requires optional hardware.
Temperature	The temperature is too low. Requires optional hardware.
GPS Com	GPS is not communicating.
GPS Lock	The GPS signal is lost.
Flow	The flow rate is too low. Requires optional hardware.
Tire Pressure	A tire's pressure is too low. Requires optional hardware.
Rain	The total rainfall is too high. Requires optional hardware.
Water Timer	The overwater shut down time has been exceeded.
Cut Cable	The span cable has been cut.
PCB Hardware	A PCB hardware issue has been detected.
12V Power	12V power has been lost.
Position Encoder Com	The position encoder is not communicating.
License	The protocol license is not valid.

Figure 61-1

Diagnostics

Error Codes

System Errors

System Error Codes are failures that may or may not shut the machine down.

When an error occurs, information about the error, including the first time and date that the error occurred, last time and date that the error occurred, and total count of all times that the error occurred, is recorded. See Figure 62-1. A list of Error Codes are shown on the next page.

Error Notification

If one or more failures occur, the word Errors will display next to the Error icon in the status area of the Main Screen. Errors must be selected as a Main Screen status for it to appear on the Main Screen. See Figure 62-1.

Viewing Error Codes

To view the Error Codes refer to Figure 62-1 and do the following:

1. Push **Menu**, **System**, **Diagnostics**, **Error Codes** and **System**.

2. Push View All Errors or View Active Errors to display the Error Codes screen.

For this example, push **View Active Errors** to view only the active errors.

Viewing an error code will clear it from the number of errors shown next to the Error icon in the status area of the Main Screen.

3. To access the desired error code do one of the following.

- Push the **Next** button to search forward through the error codes.
- Push the **Previous** button to search backward through the error codes.

Resetting Error Count

4. To set the Error Count to 0 (zero), push **Reset Count**. See Figure 62-1.

The error count is reset to zero, and the first and last error occurrences are set to the current time and date.

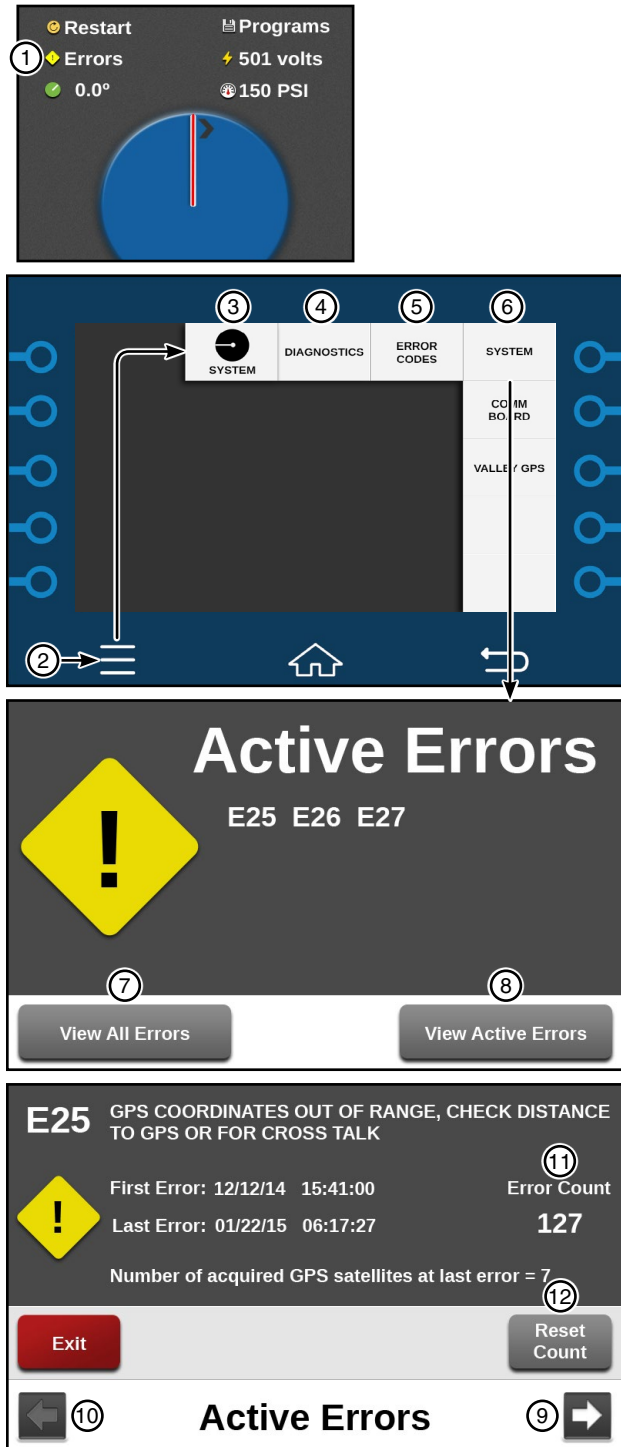

Figure 62-1

1. Error ICON	7. View All Errors
2. Menu	8. View All Active Errors
3. System	9. Next
4. Diagnostics	10. Previous
5. Error Codes	11. Error Count
6. System	12. Reset Count

Error Codes (continued)

System Error Codes and Descriptions

A list of possible System Error Codes is shown in the table below. Refer to System Error Codes on page 72 in the Troubleshooting section for possible causes and corrective action.

Error Codes	Description
E01	NVMEM corrupted
E02	PCB hardware issue
E03	Software reset - This is logged when the software resets
E04	Power dropped below low voltage limit
E05	System safety lost
E06	Pressure too low after pressure delay
E07	Pressure (mV) sensor out of range high
E08	Pressure (mV) sensor out of range low
E09	Pressure (mA) sensor out of range high
E10	Pressure (mA) sensor out of range low
E11	Pressure switch active with pump off
E12	Valley GPS pressure sensor out of range high
E13	Valley GPS pressure sensor out of range low
E14	FWD/REV Sense shorted
E15	Underwater error
E16	VDC communication error, primary COM module
E17	VRI-iS sprinkler communication error
E18	GPS communications error - check GPS connection and power
E19	GPS signal loss - check for clear path above antenna
E20	DGPS signal loss - check for clear path above antenna
E21	Flow rate below low flow limit
E22	Pressure above high pressure limit
E23	PLC communications error
E24	Valve duty cycles re synced due to high pressure
E25	GPS coordinates out of range - check distance to GPS or for crosstalk.
E26	Low tire pressure
E27	TPMS communications error
E28	VDC Error Report message received
E29	Valley GPS communication error, master OPMC
E30	Valley GPS Error Report message received

Figure 63-1

Diagnostics

Error Codes (continued)

Comm Board

Comm Board Error Codes are communications failures that may or may not shut the machine down.

The Comm Board Errors screen shows up to 6 errors. When the maximum number of 6 errors exist in the control panel memory, any new error is added to the top of the screen and the oldest record is discarded.

There is no notification that the a Comm Board Error has occurred.

A list of component IDs and possible error messages is shown on the next page. Refer to the Troubleshooting section for possible causes and corrective actions.

Viewing Error Codes

To view the errors refer to Figure 64-1 and do the following:

1. Push **Menu**, **System**, **Diagnostics**, **Error Codes** and **Comm Board**.

A maximum of 6 errors are listed on the screen, with the newest error at the top.

Clearing Error Codes

Clearing error codes will clear all Comm Board errors.

To clear the errors, push **Clear Errors**. After the errors are cleared the No Errors screen is displayed. Refer to Figure 64-1.

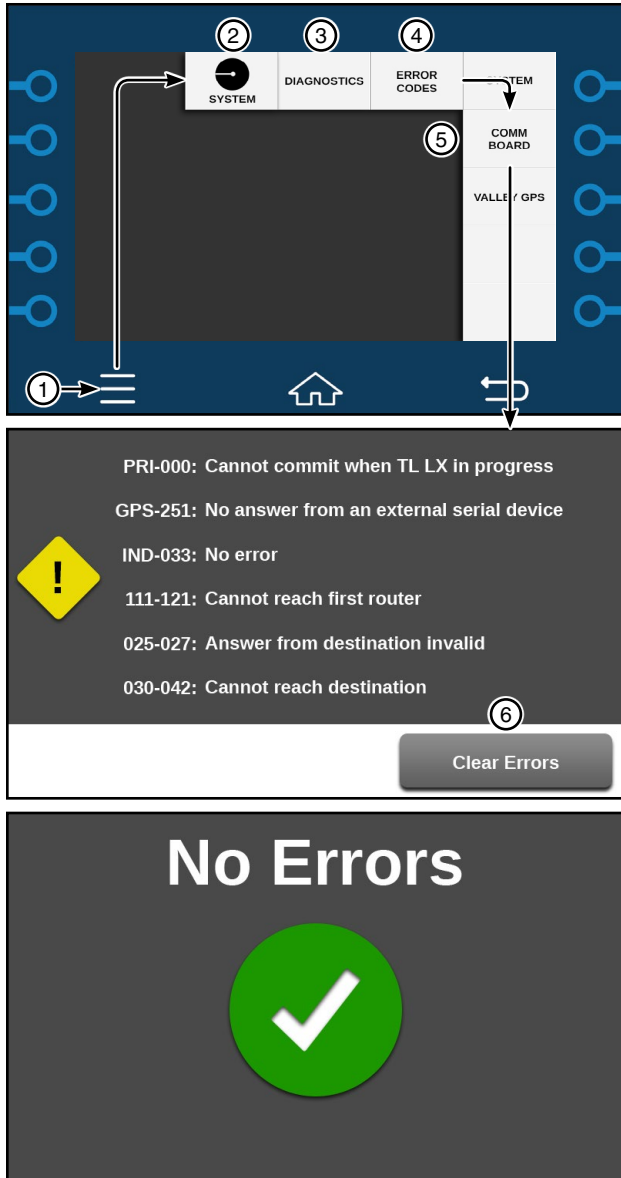

Figure 64-1 1. Menu 2. System 3. Diagnostics 4. Error Codes 5. RJ11 Comm 6. Clear Errors

Error Codes (continued)

Comm Board Component IDs / Error Messages

Shown below are the component IDs and descriptions along with the possible error messages.

ID	Description
PRI-000	Com Port in panel, Example: PRI-000 Error Message
ENC-250	Com board in Position Encoder, Example: ENC-250 Error Message
GPS-251	Com Board in GPS tower box, Example: GPS-251 Error Message
IND-XXX or XXX-XXX	Individual, Typically VRI-iS valve IDs. This can be an individual ID or a range of IDs followed by the error message. Example: Individual ID, IND-033 Error Message - or - Range of IDs, 111-121 Error Message

Error Messages

No Error
Invalid Request Length
Invalid Request Data
Invalid Request ID
Production Mode Not Activated
Serial Rx Buffer Full
CLTX Buffer Full
Cannot Commit When PLTX In Progress
No Answer From External Device Serial
Cannot Reach First Router
No Answer From Destination
Cannot Reach Destination
Answer From Destination Invalid

Figure 65-1

Diagnostics

Error Codes (continued)

Valley GPS Errors

Valley GPS Error Codes are communications failures that may or may not shut the machine down.

The Valley GPS Errors screen shows up to four errors. When the maximum number of four errors exist in the control panel memory, any new error is added to the top of the screen and the oldest record is discarded.

There is no notification that the Valley GPS Error has occurred.

A list of Valley GPS error IDs and descriptions is shown on the next page. Refer to the Troubleshooting section for possible causes and corrective actions.

Viewing Error Codes

To view the Valley GPS errors push **Menu**, **System**, **Diagnostics**, **Error Codes** and **Valley GPS**. Refer to Figure 66-1.

A maximum of four errors are listed on the screen, with the newest error at the top.

Clearing Error Codes

Clearing error codes will clear all Valley GPS errors.

To clear the errors, push **Clear Errors** and then push **Clear**. Refer to Figure 66-1.

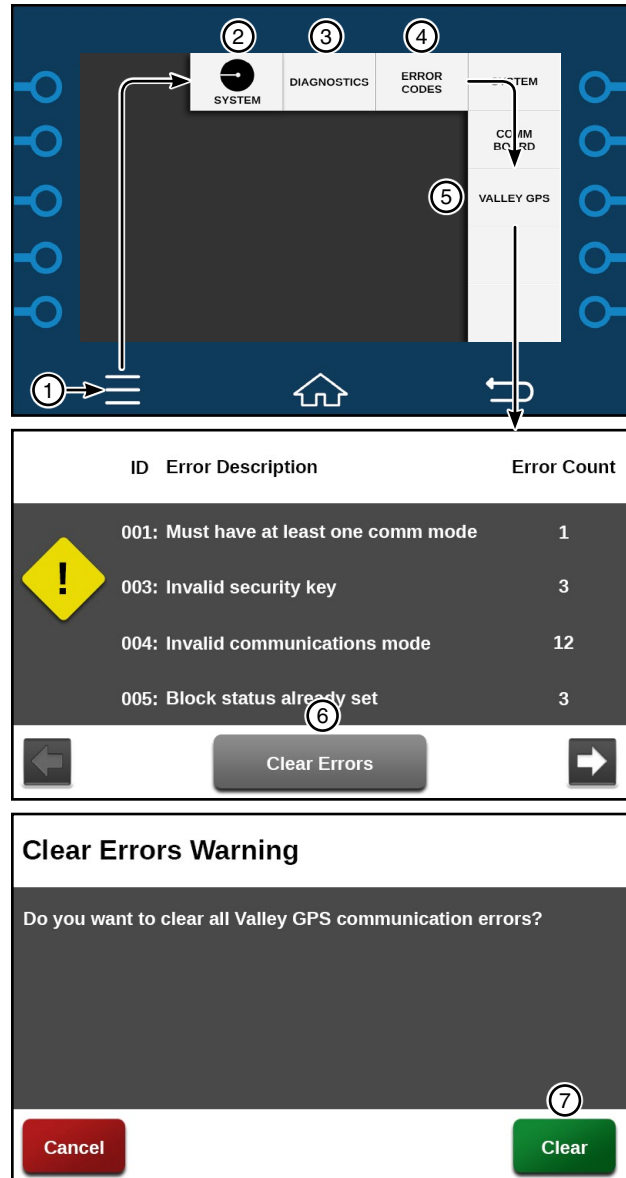

Figure 66-1 1. Menu 2. System 3. Diagnostics 4. Error Codes 5. Valley GPS 6. Clear Errors 7. Clear

Error Codes (continued) Valley GPS Error IDs and Descriptions

ID	Description
000	No Error
001	No Comm Mode
003	Invalid Security Key
004	Invalid Communications Mode
005	Block Status Already Set
010	Invalid Request Length
011	Invalid Data Request
012	Invalid ID Request
013	Production Mode Not Activated
014	Record Noise After Packet Reception
015	No Device To Be Discovered In MAC List
016	No Device To Be Recovered In Routing Table
017	FLASH Error
018	FLASH Verification Error
021	Serial Rx Buffer Full
022	GPS Buffer Full
023	Tx Error
030	Cannot Commit When GPS message In Progress
031	No Answer From External Serial Device
033	Cannot Reach First Router
034	No Answer From Destination
035	Cannot Reach Destination
036	Answer From Destination Invalid
040	Invalid Request For Current Board ID
050	Invalid Page In EEPROM Access
051	EEPROM Write Error
052	External PLP Process Running
053	OS Task Running
082	Cannot Reach First Router
0C1	Cannot Reach PLC Destination
0FD	Boot Loader Flash Error
0FE	Not Supported
0FF	NACK
	Unknown error code

Figure 67-1

History

History provides a record of the 50 most recent machine operation status changes via the Standard and Advanced Screens. Refer to Figure 68-1.

The history record number appears at the bottom of the screen with the date and time of the record. Number 01 is the newest status change and number 50 is the oldest status change.

When the maximum number of 50 records exist in the control panel memory, any new status change is added as record number 01 and the oldest record is discarded.

Viewing Standard History

1. To view Standard History, push **Menu**, **System**, **History**, and **Standard History**. See Figure 68-1.

The Standard History Screen shows a snapshot of the Main Screen on the date and time the history record was created.

2. To access the desired history record do one of the following.
 - Push the **Next** button to search forward through the History Records.
 - Push the **Previous** button to search backward through the History Records.
3. To leave Standard History and view Advanced History, push the **Advanced History** button.

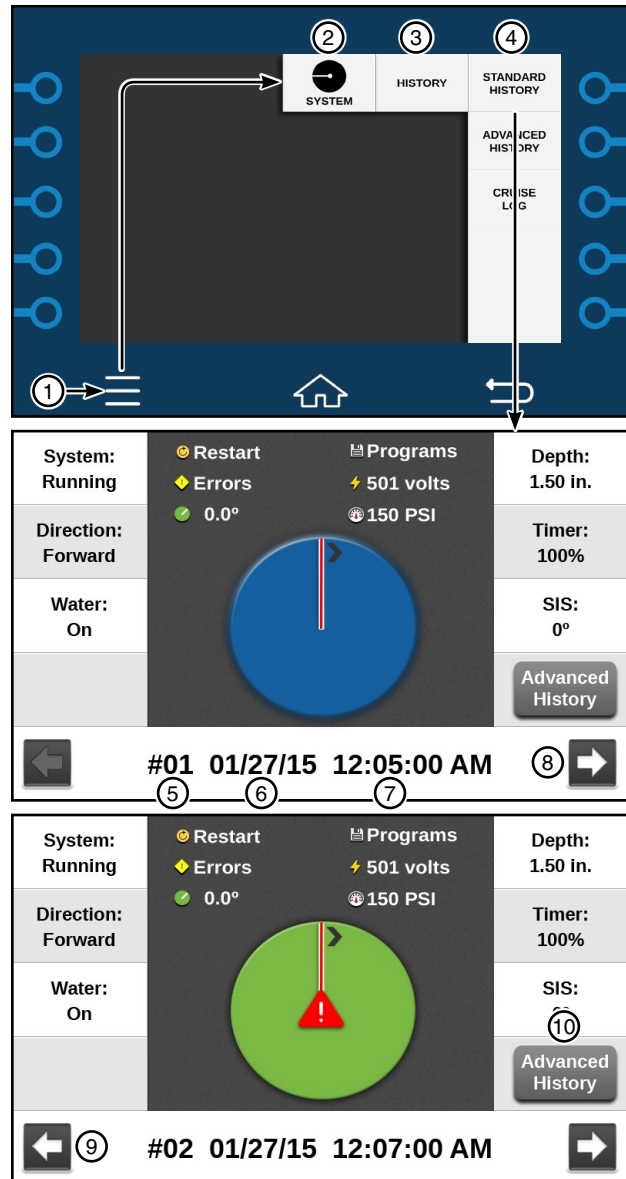

Figure 68-1

1. Menu	6. Date
2. System	7. Time
3. History	8. Next
4. Standard History	9. Previous
5. Record Number	10. Advanced History

Viewing Advanced History

The Advanced History Screen displays a record of all statuses and error codes related to the history record. Refer to Figure 69-1.

View additional information including the event that triggered this history record.

A list of trigger events is shown on the next page.

1. To view Advanced History, push **Menu**, **System**, **History**, and **Advanced History**. See Figure 69-1.
2. To access the desired history record do one of the following.
 - Push the **Next** button to search forward through the History Records.
 - Push the **Previous** button to search backward through the History Records.
3. Use the **Next Status** and **Previous Status** buttons to navigate through the Advanced History record.
4. To leave Advanced History and view the Standard History Screen, push the **Standard History** button.

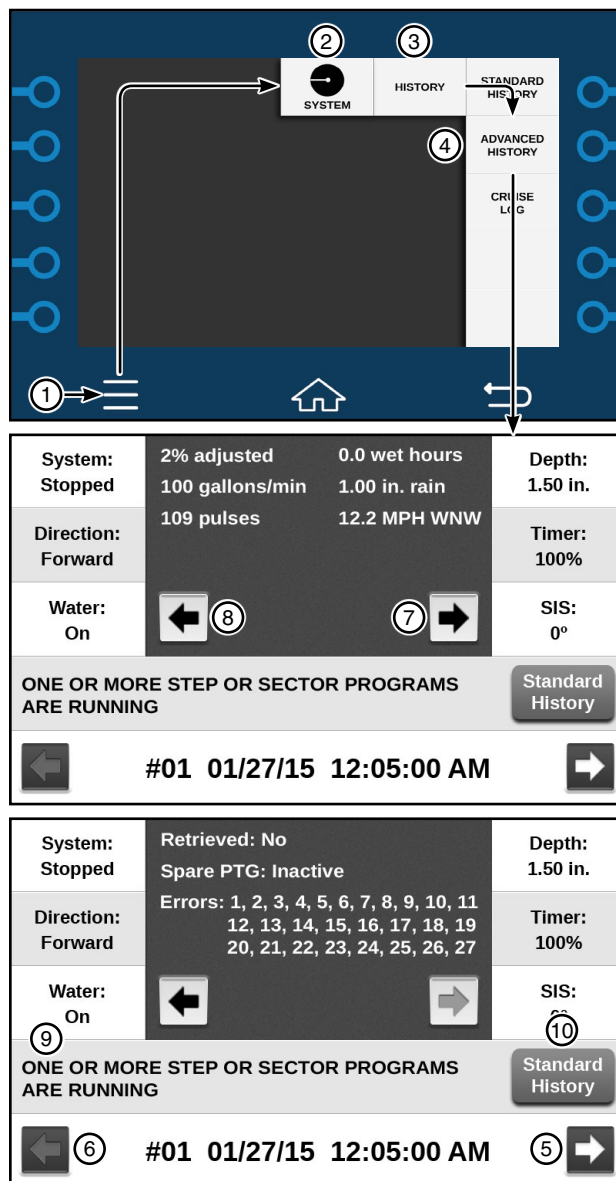

Figure 69-1

1. Menu	6. Previous
2. System	7. Next Status
3. History	8. Previous Status
4. Advanced History	9. Trigger Event
5. Next	10. Standard History

History

History Screen Events

The following is a list of events that trigger the creation of history records. The event appears on the history record when viewed on the Advanced History Screen.

Event	System Faults
System_Run_Stop_Status change	Stopped - System Power Lost Fault
System_Percent_Timer change	Stopped - System Safety Fault
System went from no programs running to one or more step or sector programs running, or vice-versa	Stopped - Low Pressure Fault
Log Event program command executed	Stopped - Command Fault
Auto_Restart_Possible change	Stopped - SIS Fault
Daily_Ops_Restart_Possible change	Stopped - NVMEM Fault
Cycle_Repeat_Restart_Possible change	Stopped - For/Rev Fault
System_Direction change	Stopped - Operating Sector Fault
System_Water On/Off change	Stopped - Wind Fault
SIS_Control On/Off change	Stopped - Temperature Fault
SIS_Position change	Stopped - Daily Ops Fault
Cruise_Control enabled/disabled change	Stopped - GPS Com Fault
VRI-S_Status active/inactive change	Stopped - GPS Lock Fault
VRI-Z_Status active/inactive change	Stopped - Program Fault
VRI-iS_Status active/inactive change	Stopped - Auto-Stop Fault
Aux1 In active/inactive change	Stopped - Flow Fault
Aux2 In active/inactive change	Stopped - High Pressure Fault
Aux1 Out On/Off change	Stopped - Tire Pressure Fault
Aux2 Out On/Off change	Stopped - Rain Fault
End Gun On/Off change	Stopped - Water Timer Fault
Wide Boundary #1 On/Off change	Stopped - Cut Cable
Wide Boundary #2 On/Off change	Stopped - PCB Hardware Fault
Wide Boundary #3 On/Off change	Stopped - 12V Power Fault
Spare pull-to-ground input active/inactive change	Stopped - Position Encoder Com Fault
System crossed SIS_Position	Stopped - System Power Low Fault
Date changed (midnight)	Stopped - License Fault

Figure 70-1

Cruise Log

The Cruise Log Screen records the Percent Timer adjusted setting every 5° from the start position, regardless of the resolution setting.

1. To view the Cruise Log, push **Menu, System, History, Cruise Log**. See Figure 71-1.
2. To access the desired history record do one of the following.
 - Push the **Next** button to search forward through the Cruise Log Records.
 - Push the **Previous** button to search backward through the Cruise Log Records.

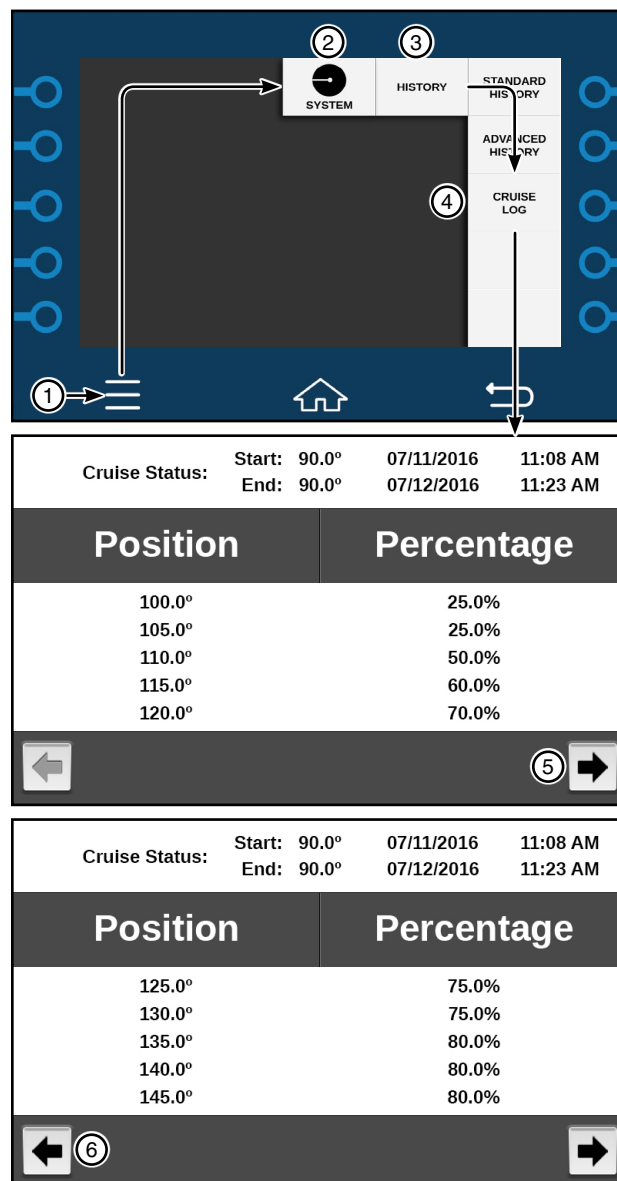

Figure 71-1 1. Menu 4. Cruise Log
 2. System 5. Next
 3. History 6. Previous

Troubleshooting

Use this Troubleshooting section with the machine owner's manual to diagnose and troubleshoot problems with the machine and/or control panel.

Always perform service or maintenance safely, use personal protection equipment when required, maintain a minimum working clearance around the control panel and other equipment, use fall protection when required, and always use at least the minimal lockout/tagout procedure when maintaining or servicing the machine. For more information refer to the Safety section.

WARNING

TO REDUCE THE POSSIBILITY OF SEVERE INJURY OR DEATH:

- **TROUBLESHOOTING OR REPAIRING ELECTRICAL PROBLEMS SHOULD ONLY BE PERFORMED BY A QUALIFIED VALLEY DEALER.**
- **ALWAYS CONTACT YOUR LOCAL VALLEY DEALER TO TROUBLESHOOT OR CORRECT ANY ELECTRICAL PROBLEMS ON OR ASSOCIATED WITH THE CONTROL PANEL OR MACHINE. NEVER ATTEMPT TO TROUBLESHOOT OR CORRECT ELECTRICAL PROBLEMS ON YOUR OWN.**
- **USE PERSONAL PROTECTION EQUIPMENT WHEN REQUIRED.**
- **MAINTAIN A MINIMUM WORKING DISTANCE AROUND THE CONTROL PANEL AND OTHER EQUIPMENT.**
- **USE FALL PROTECTION WHEN REQUIRED.**
- **BEFORE SERVICING OR PERFORMING MAINTENANCE ON THE MACHINE, ALWAYS SHUT OFF ALL ELECTRICAL POWER TO THE CONTROL PANEL AND MACHINE, THEN USE THE MINIMAL LOCKOUT/TAGOUT PROCEDURE ON THE SERVICE DISCONNECT AND CONTROL PANEL.**

System Stops and Faults

Listed in the table below and on the following pages are the possible system stops and faults with the description, possible causes, whether the machine will shutdown if the error occurs, and corrective action to take.

System Stop	Threshold	Shut Down	Corrective Action
Command <ul style="list-style-type: none"> • User commanded stop 	The machine was intentionally commanded to stop by pushing the Stop button.	Yes	Normal operation - No corrective action needed.
Stop-In-Slot (SIS) <ul style="list-style-type: none"> • SIS position reached 	The current machine position matches the Stop-In-Slot position while the machine was waiting/running.	Yes	Normal operation - No corrective action needed.
Daily Ops <ul style="list-style-type: none"> • Daily operation sequence completed 	With the Daily Ops Control enabled and Daily Ops Mode selected, the system was started outside of the start/stop range of Daily Ops.	Yes	Normal operation - No corrective action needed. If desired, reprogram Daily Ops to run at a different time or disable Daily Ops.
Program <ul style="list-style-type: none"> • Program stop command 	A stop command in a step or sector program shut down the machine.	Yes	Normal operation - No corrective action needed.
Auto-Stop <ul style="list-style-type: none"> • Auto-Stop boundary reached 	The Auto Stop boundary was reached and shut down the machine.	Yes	Normal operation - No corrective action needed.

System Stops and Faults (continued)

System Fault	Threshold	Shut Down	Corrective Action
System Power Lost <ul style="list-style-type: none"> Machine power is lost 	Voltage dropped below half the low voltage limit for 3 seconds or more while the machine was waiting/running with water on or more than 1 second if running with water off.	Yes	Check Low Voltage Limit for correct value. Contact your Valley dealer.
System Power Low <ul style="list-style-type: none"> Machine power is too low 	Voltage fell below the low voltage limit for 15 seconds or more while the machine was waiting/running.	Yes	Check power supply.
System Safety <ul style="list-style-type: none"> Machine safety not sensed 	Safety circuit was de-energized for more than 3 seconds.	Yes	Make sure a tower is not stuck. Check for flat tire on a tower. Check for wheel gearbox failure. Check End-Of-Field Stop for proper operation. Contact your Valley dealer.
Low Pressure <ul style="list-style-type: none"> Water pressure is too low 	Water pressure fell below the Low Pressure Limit for more than the Operating Pressure Delay time while the machine was running with water on and after the Startup Pressure Delay has expired.	Yes	Make sure pump is on. Set Low Pressure Limit higher. Set Operating Pressure Delay for longer period of time. Contact your Valley dealer.
High Pressure <ul style="list-style-type: none"> Water pressure is too high 	Water pressure remained above the High Pressure Limit for at least the High Pressure Shutdown Delay time.	Yes	Contact your Valley dealer.
NVMEM <ul style="list-style-type: none"> E01 error is active 	E01 error is active, Memory Error, Backup Battery failure.	Yes	Contact your Valley dealer.
Forward/Reverse <ul style="list-style-type: none"> Both For/Rev circuits are energized 	Both the forward and reverse circuits were on for more than 15 seconds while the machine was waiting/running.	Yes	Contact your Valley dealer.
Operating Sector <ul style="list-style-type: none"> Machine position is not within the operating sector 	With AR/AS and For/Rev Position both enabled, the machine is waiting/running or was started outside of the Forward or Reverse Position angles.	Yes	Walk the machine back. Check the For/Rev Position angles. Contact your Valley dealer.
Wind <ul style="list-style-type: none"> Wind is too high 	With Wind Shutdown enabled, the Wind Speed went above the Wind Speed Limit for more than 1 minute while the machine is running with water on. Requires optional equipment.	Yes	Normal operation - No corrective action needed.
Temperature <ul style="list-style-type: none"> Temperature is too low 	With the Temperature Shutdown enabled, the Current Temperature goes below the Low Temperature Limit while water is on. Requires optional equipment.	Yes	Restart the machine when the temperature rises above the limit.
Rain <ul style="list-style-type: none"> Total rainfall is too high 	With the Rain Shutdown enabled, the Total Rainfall for the Rain Window goes above the Rain Shutdown Limit while water is on. Requires optional equipment.	Yes	Turn Rain Shutdown Off, or restart the machine when the Rain Total is below the Rain Limit.

Troubleshooting

System Stops and Faults (continued)

System Fault	Threshold	Shut Down	Corrective Action
Flow <ul style="list-style-type: none"> Flow rate is too low 	While the machine is running with water on, the Flow Rate falls below the Low Flow Limit after adequate water pressure has been achieved.	Yes	Contact your Valley dealer.
Water Timer <ul style="list-style-type: none"> Overwater shut-down time exceeded 	With the Water Timer enabled, the time accumulated by the Overwater Timer is greater than the Overwater Shutdown time.	Yes	Contact your Valley dealer.
Tire Pressure <ul style="list-style-type: none"> A tire's pressure is too low 	With Shutdown Pressure Control enabled, the Reported Tire Pressure of a tire is below the Nominal Tire Pressure for that tire's tower by at least the Shutdown Pressure Drop for two consecutive sensor readings. This is checked only on the reception of new tire pressure sensor data. Requires optional equipment.	Yes	View error E26 to determine which tower has a tire with low pressure. Check the tires on the tower for low pressure, and repair as needed. Contact your Valley dealer.
GPS Com <ul style="list-style-type: none"> GPS not communicating 	With GPS Position and Shutdown On Position Loss enabled, while the machine is waiting/running there has been no GPS communications and the Shutdown On Position Loss Delay time has expired. Requires optional equipment.	Yes	Contact your Valley dealer.
GPS Lock <ul style="list-style-type: none"> GPS signal loss 	With GPS Position and Shutdown On Position Loss enabled, while the machine is waiting/running the GPS Lock Status is None and the Shutdown On Position Loss Delay time has expired. Requires optional equipment.	Yes	Check for a clear path above the GPS antenna. Contact your Valley dealer.
Cut Cable <ul style="list-style-type: none"> Span cable has been cut 	A cut cable was Detected when the machine was started.	Yes	Check span cable Contact your Valley dealer.
PCB Hardware <ul style="list-style-type: none"> PCB hardware issue detected 	PCB hardware issue detected while the machine is waiting/running.	Yes	Review Error E02 for which PCB hardware issue caused the fault. Contact your Valley dealer.
12V Power <ul style="list-style-type: none"> 12V power is lost 	With Backup Battery enabled: The battery backup supply voltage fell below 10 volts or the unit has been powered from the battery backup supply and the Battery Backup Time has expired. Requires optional equipment.	Yes	Contact your Valley dealer.
Position Encoder Com <ul style="list-style-type: none"> Position encoder not communicating 	With the Position Encoder option and Shutdown On Position Loss enabled, and while the machine is waiting/running the position encoder has not been communicating and the Shutdown On Position Loss Delay time has expired.	Yes	Contact your Valley dealer.
License	The protocol license is not valid.	Yes	Normal shutdown the first time that a communications device talks to the control panel while the machine is running. Contact your Valley Dealer.

System Error Codes

Listed in the table below and on the following pages are the possible system errors with the description, threshold for the error to occur, whether the machine will shutdown if the error occurs and possible causes.

Error	Description	Threshold	Shut Down	Possible Causes Corrective Actions
E01	NVMEM Corrupted.		Yes	Contact your Valley Dealer.
E02	PCB Hardware Issue #1	The cut cable relay digital input failed to become active after the relay was energized.	Yes	Contact your Valley Dealer.
	PCB Hardware Issue #2	The cut cable relay digital input was active while the machine was waiting/running.	Yes	Contact your Valley Dealer.
	PCB Hardware Issue #3	The 5 volt regulator output is turned Off while the machine was waiting/running.	Yes	Contact your Valley Dealer.
	PCB Hardware Issue #4	The main supply input is out of range (High).	Yes	Contact your Valley Dealer.
	PCB Hardware Issue #5	The battery charging voltage is out of range (High).	Yes	Contact your Valley Dealer.
	PCB Hardware Issue #6	The battery charging voltage is out of range (Low).	Yes	Contact your Valley Dealer.
	PCB Hardware Issue #7	The switched 12V power output is out of range (High).	Yes	Contact your Valley Dealer.
	PCB Hardware Issue #8	The switched charging voltage is out of range (Low).	Yes	Contact your Valley Dealer.
	PCB Hardware Issue #9	The thermally fused 12V sensor power output is out of range (High).	Yes	Contact your Valley Dealer.
	PCB Hardware Issue #10	The thermally fused 12V sensor power output is out of range (Low).	Yes	Contact your Valley Dealer.
	PCB Hardware Issue #11	The thermally fused 12V daughter card power output is out of range (High).	Yes	Contact your Valley Dealer.
	PCB Hardware Issue #12	The thermally fused 12V daughter card power output is out of range (Low).	Yes	Contact your Valley Dealer.
	PCB Hardware Issue #13	The 5 volt regulator output is out of range (High).	Yes	Contact your Valley Dealer.
	PCB Hardware Issue #14	The 5 volt regulator output is out of range (Low).	Yes	Contact your Valley Dealer.
	PCB Hardware Issue #15	The thermally fused 5 volt sensor power output is out of range (High).	Yes	Contact your Valley Dealer.
	PCB Hardware Issue #16	The thermally fused 5 volt sensor power output is out of range (Low).	Yes	Contact your Valley Dealer.
	PCB Hardware Issue #17	The 3.3 volt regulator output is out of range (High).	Yes	Contact your Valley Dealer.
	PCB Hardware Issue #18	The 3.3 volt regulator output is out of range (Low).	Yes	Contact your Valley Dealer.
E03	Software Reset <ul style="list-style-type: none"> Logged every time the software resets 	When the software is power cycled or reset.	No	Normal operation.

Troubleshooting

System Error Codes (continued)

Error	Description	Threshold	Shut Down	Possible Causes Corrective Actions
E04	Power Dropped Below Low Voltage Limit <ul style="list-style-type: none"> This error is only logged if it is not already active. 	When machine is waiting/ running, and voltage drops below Low Voltage Limit.	Yes - by System Power Low fault after 15 seconds.	Nuisance shutdowns can be caused by setting the Low Voltage Limit too high. Contact your Valley Dealer.
E05	System Safety Lost	When the machine is running and Safety In is de-energized.	Yes - by System Safety fault after 3 seconds.	The safety circuit is open due possibly to misaligned towers, guidance problems, over-watering timer timed out, or any other component in the safety circuit. Contact your Valley Dealer.
E06	Pressure Too Low After Pressure Delay <ul style="list-style-type: none"> This error is only logged if it is not already active. 	While running with water on and after Startup Pressure Delay expires Low water pressure is reported by any pressure sensor selected for the Running input.	Yes - by Low Pressure fault after operating pressure delay expires.	Startup pressure delay time is too short. The pump, pressure transducer, or pressure switch may have failed. Low pressure limit set too close to operating pressure. Contact your Valley Dealer.
E07	Pressure (mV) Sensor Out of Range High <ul style="list-style-type: none"> This error is only logged if it is not already active. 	When (mV) pressure is greater then the calculated Max Sensor Pressure. The (mV) pressure sensor must be selected for the Stopped or Running input.	No	The pressure sensor has failed. Contact your Valley Dealer.
E08	Pressure (mV) Sensor Out of Range Low <ul style="list-style-type: none"> This error is only logged if it is not already active. 	When (mV) pressure is < -6 psi. The (mV) pressure sensor must be selected for the Stopped or Running input.	No	The pressure sensor has failed or is not installed. Contact your Valley Dealer.
E09	Pressure (mA) Sensor Out of Range High <ul style="list-style-type: none"> This error is only logged if it is not already active. 	When (mA) pressure is greater then the calculated Max Sensor Pressure. The (mA) pressure sensor must be selected for the Stopped or Running input.	No	The pressure sensor has failed. Contact your Valley Dealer.
E10	Pressure (mA) Sensor Out of Range Low <ul style="list-style-type: none"> This error is only logged if it is not already active. 	When (mA) pressure is < -6 psi. The (mA) pressure sensor must be selected for the Stopped or Running input.	No	The pressure sensor has failed or is not installed. Contact your Valley Dealer.
E11	Pressure Switch Active With Pump Off <ul style="list-style-type: none"> This error is only logged if it is not already active. 	When the Pump Safety Relay is Off for more than 5 minutes and the pressure switch is still on.	No	The pressure switch has failed, is stuck, or water is still in riser pipe possibly because of a plugged machine drain. Contact your Valley dealer.

System Error Codes (continued)

Error	Description	Threshold	Shut Down	Possible Causes Corrective Actions
E12	Valley GPS pressure sensor out of range high <ul style="list-style-type: none"> This error is only logged if it is not already active. 	When Valley GPS pressure is greater than the calculated Max Sensor Pressure. The Valley GPS pressure sensor must be selected for the Running input.	No	The pressure sensor has failed, calibration or setup is incorrect, or the Max pressure is set too low. Contact your Valley Dealer.
E13	Valley GPS pressure sensor out of range low <ul style="list-style-type: none"> This error is only logged if it is not already active. 	When Valley GPS pressure is < -6 psi. The Valley GPS pressure sensor must be selected for the Running input.	No	The pressure sensor has failed or is not installed. Contact your Valley Dealer.
E14	FWD/REV Sense Possible Short <ul style="list-style-type: none"> The machine status will show running when AR/AS is Off even though the motor contactor is disabled. The machine will stop if AR/AS is on and Auto Stop is selected. If AR/AS is on and Auto Reverse is selected, the machine will alternate between forward and reverse direction control. Since motor power is disabled until the direction has locked in, the machine will not move. Error will not be logged again until one or both of the lines have been de-energized for a minimum of 1 second. 	When both the forward and reverse run lines are energized. Logged after 2 seconds when AR/AS is enabled. Logged Immediately when AR/AS is disabled.	Yes - by FWD/REV Fault after 15 seconds if machine is waiting/ running regardless of AR/AS settings.	Contact your Valley Dealer.
E15	Underwater Error <ul style="list-style-type: none"> This error is only logged if it is not already active. Watering Timer must be enabled. 	When the 5° Run Timer value is less than the Error Time value.	No	Contact your Valley Dealer.
E16	VDC Communication Error, Primary Communication Module	Each time a command message is sent with no reply message being received (VRI-iS or Encoder options only).	Yes - if Position Loss Shut Down is enabled.	Communications error to Comm Board. Contact your Valley Dealer.

Troubleshooting

System Error Codes (continued)

Error	Description	Threshold	Shut Down	Possible Causes Corrective Actions
E17	VRI-iS Sprinkler Communication Error <ul style="list-style-type: none"> The sprinkler ID and number of occurrences for this sprinkler are logged with the error. 	Each time a sprinkler fails to respond to a Set Sprinkler command retry.	No	Communications error to VRI-iS valve. Contact your Valley Dealer.
E18	GPS Communication Error	When a transition occurs from GPS communicating to GPS not communicating. GPS Position must be enabled.	Yes - if Shut Down System is selected.	When GPS option is powered by safety circuit, a loss of power will cause this error.
E19	GPS Signal Loss	When the GPS Lock Status transitions from Standard to DGPS or None. GPS Position must be enabled.	Yes - if Shut Down System is selected.	Check for clear path above the GPS antenna.
E20	DGPS Signal Loss <ul style="list-style-type: none"> The Satellite Count is logged with the error. 	When the GPS Lock Status transitions from DGPS to Standard. GPS Position must be enabled.	No	Check for clear path above the GPS antenna.
E21	Flow Rate Below Low Flow Limit	After operating pressure has been achieved, while the Machine is running with water on, the flow rate fell below the low flow limit. Minimum flow rate must be enabled.	Yes - by Flow Fault.	Low Flow Limit may be set too high.
E22	Pressure Above High Pressure Limit <ul style="list-style-type: none"> Error is logged every time the water pressure rises above the High Pressure Limit. 	Every time the water pressure rises above the High Pressure Limit.	Yes - by High Pressure Fault after the High Pressure Shutdown Delay of 15 seconds.	Max pressure may be set too low. Contact your Valley Dealer.
E23	PLC Communication Error <ul style="list-style-type: none"> The OPMC ID is logged with the error. 	After 3 consecutive command messages are sent to an OPMC ID with no reply message being received.	No	Verify Correct PLC Channel and ID Settings.
E24	Valve Duty Cycles Re-Synced Due to High Pressure	When the water pressure exceeds the VRI Resync Pressure.	No	The machine water pressure is equal to the valve resync water pressure setting. The valve duty cycle is automatically re-synchronized. Verify that the valve resync pressure is not set too low.

System Error Codes (continued)

Error	Description	Threshold	Shut Down	Possible Causes Corrective Actions
E25	<p>GPS Coordinates Out of Range</p> <ul style="list-style-type: none"> The Satellite Count is logged with the error. 	When GPS coordinates are out of range.	Yes, if Shut Down System is selected.	<p>Verify that Distance to GPS, Radius + or Radius -, values are correct.</p> <p>Verify that pivot point coordinates are correct.</p> <p>Crosstalk from another GPS device on the same channel.</p> <p>Change GPS PLC to different channel to avoid crosstalk.</p>
E26	<p>Low Tire Pressure</p> <ul style="list-style-type: none"> The tower number is logged with the error. The error is logged for only one tower at a time. If the error is already logged on a tower, errors on a different tower will not be logged. Correct the problem and clear the error log to view other occurrences. 	When new data indicates a tire with pressure at or below the tire pressure warning value is on the indicated tower.	Yes - after 2 consecutive readings of pressure below Shutdown Pressure Drop if Shutdown Pressure is enabled.	At least one tire on the indicated tower has low pressure.
E27	<p>TPMS Communications Error</p> <ul style="list-style-type: none"> The TPMS ID is logged with the error. 	After 3 consecutive command messages are sent to an TPMS ID with no reply message being received.	No	Contact your Valley Dealer.
E28	VDC Error Report Message Received	When a Communication board error report message is received from the comm board.	No	<p>An error report was generated in response to a command.</p> <p>View the Error Report in System/Diagnostics/Error Codes/Comm Board.</p>
E29	Valley GPS communication error, master OPMC	The SRB was unable to communicate to the master OPMC.	No	Contact your Valley Dealer.
E30	Valley GPS Error Report message received	When a communication Error Report message is received from the PLC.	No	<p>An error report was generated in response to a command.</p> <p>View the Error Report in System/Diagnostics/Error Codes/Valley GPS.</p>

Troubleshooting

Troubleshooting List

Listed in the table below and on the following page are various problems, with the descriptions and possible causes or corrective action to take.

Problem	Possible Cause or Corrective Action
Encoder position is not accurate.	Pivot point binding.
	J-tube overtightened or seized.
	Pipe not secured to H-bracket.
	Collector ring loose.
	Direction Offset incorrect.
	Contact your Valley dealer.
Pivot auto reverses randomly.	Contact your Valley dealer.
Pivot auto stops randomly.	Contact your Valley dealer.
Pivot breaks safety at barricade.	Barricade too high on actuator arm.
	Auto-Reverse/Auto-Stop disabled.
	Auto-Reverse/Auto-Stop box not adjusted correctly.
	Contact your Valley dealer.
Pressure sensor reading incorrect.	Calibrate sensor without water.
	Check valve holding water in riser.
	Ice against sensor.
	Sensor plugged.
	Pressure tube plugged or damaged.
	Contact your Valley dealer.
No display.	Disconnect switch Off.
	No Power To Machine.
	Contact your Valley dealer.
End gun does not shut off.	End Gun angles not programmed correctly.
	"T" filter plugged.
	Defective end gun hardware.
	Direction offset incorrect; arc too small.
	Contact your Valley dealer.
End gun does not turn on.	End Gun angles not programmed correctly.
	End Gun disabled.
	Defective end gun hardware.
	Contact your Valley dealer.
Screen cycles on and off.	Erratic incoming power.
	Low voltage.
	Contact your Valley dealer.

Troubleshooting List (continued)

Problem	Possible Cause or Corrective Action
Pivot does not stop at stop-in-slot.	Stop-In-Slot not turned on.
	Stop-In-Slot position has been changed.
	Machine must move at least 2° away from the Stop-In-Slot position before it can be stopped again by Stop-In-Slot.
	Contact your Valley dealer.
Pivot won't auto restart.	START\$ program written incorrectly or missing.
	Restart criteria has not been met.
	Off day in Daily Ops.
	System fault other than power or pressure.
	Contact your Valley dealer.
Pivot won't stop with Daily Ops.	Start/stop times reversed.
	Daily Ops not enabled.
	A program other than Daily Ops starts machine.
	The STOP\$ Program must be set to stop.
	Contact your Valley dealer.
Auto Restart does not work.	Make sure a Start\$ program is entered.
	System fault must be either power or pressure for restart to work.
	Verify that Auto Restart is enabled and on.
	Contact your Valley dealer.

Troubleshooting

ICON5 Software

Update ICON5 Software

To execute a Software Update, refer to Figure 82-1 and do the following:

1. Stop the machine.
2. Insert the USB flash drive containing the software update into the USB port on the front of control panel.
3. Push **Menu**, **System**, **Diagnostics**, **Firmware**, and **ICON5 Software**.
4. Push **Update ICON5 software**.
5. Push **Yes** to start the update process.
6. Push **Read USB** to show the files that are on the flash drive.

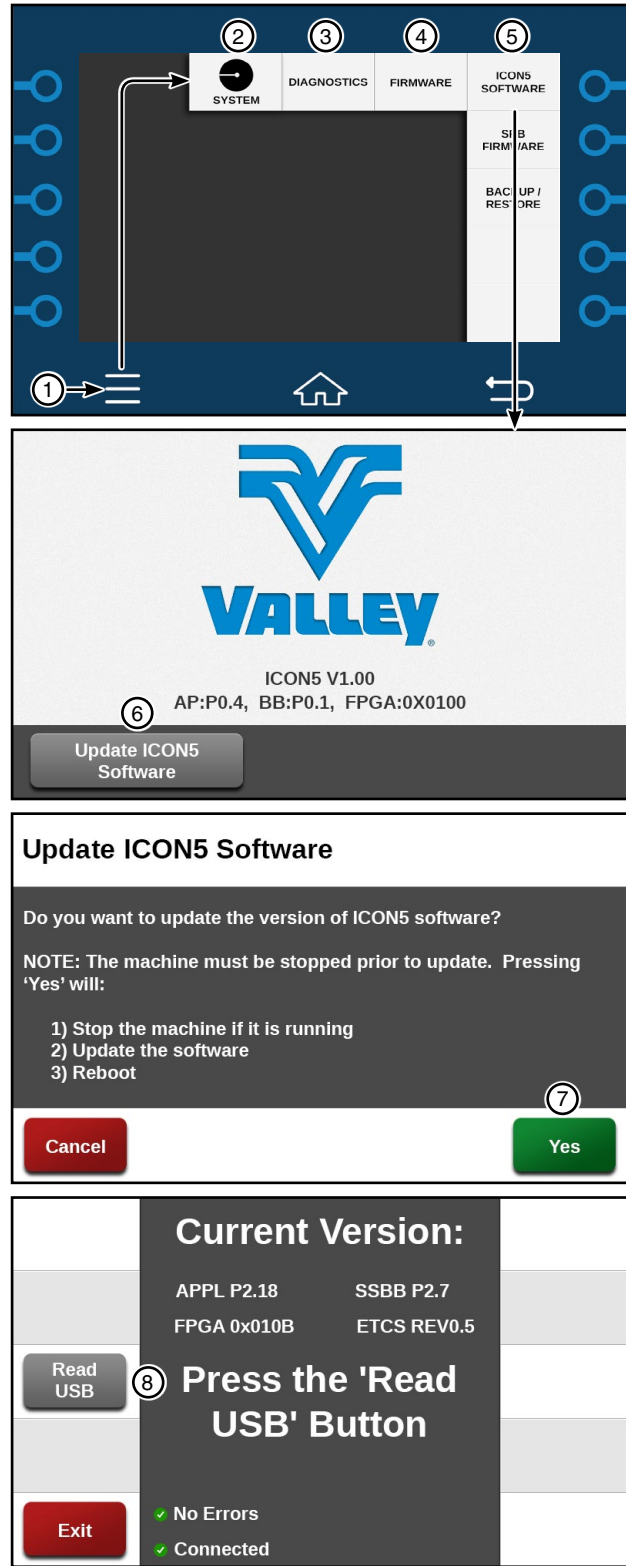

Figure 82-1 1. Menu 2. System 3. Diagnostics 4. Firmware 5. ICON5 Software 6. Update ICON5 Software 7. Yes 8. Read USB

ICON5 Software

Update ICON5 Software (continued)

7. Select a file to install.
8. Push **Program File** to update the software.
The control panel will update the ICON5 Software and then automatically reboot.
9. After the ICON5 Software update completes, the USB flash drive can be removed.

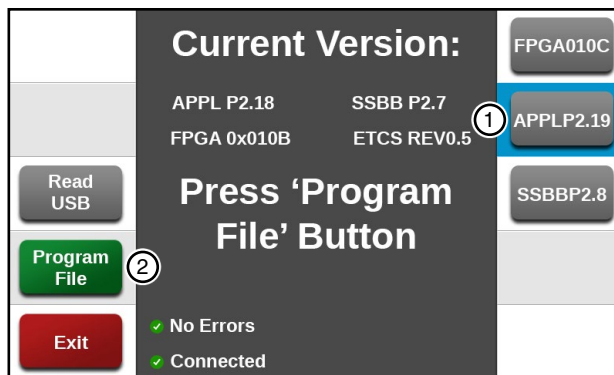

Figure 83-1 1. Select File
2. Program File

Troubleshooting

Smart Relay Board

SRB Default Reset

SRB Default Reset, resets the Electrically Erasable Programmable Read-Only Memory to factory default settings.

- Resets current status to factory settings
- Resets all constants to factory settings
- Resets all options to factory settings
- Erases all current and stored programs
- Clears Review History
- Clears Error Log history

To execute an SRB Default Reset, refer to Figure 84-1 and do the following:

Backup or record all options settings, constants settings, and programs that will need to be restored or re-entered after the default reset.

1. Push **Menu**, **System**, **Diagnostics**, **Firmware**, and **SRB Firmware**.
2. Push **SRB Default Reset**.
3. Push **Yes** to set the Smart Relay Board to factory defaults and reboot the control panel.

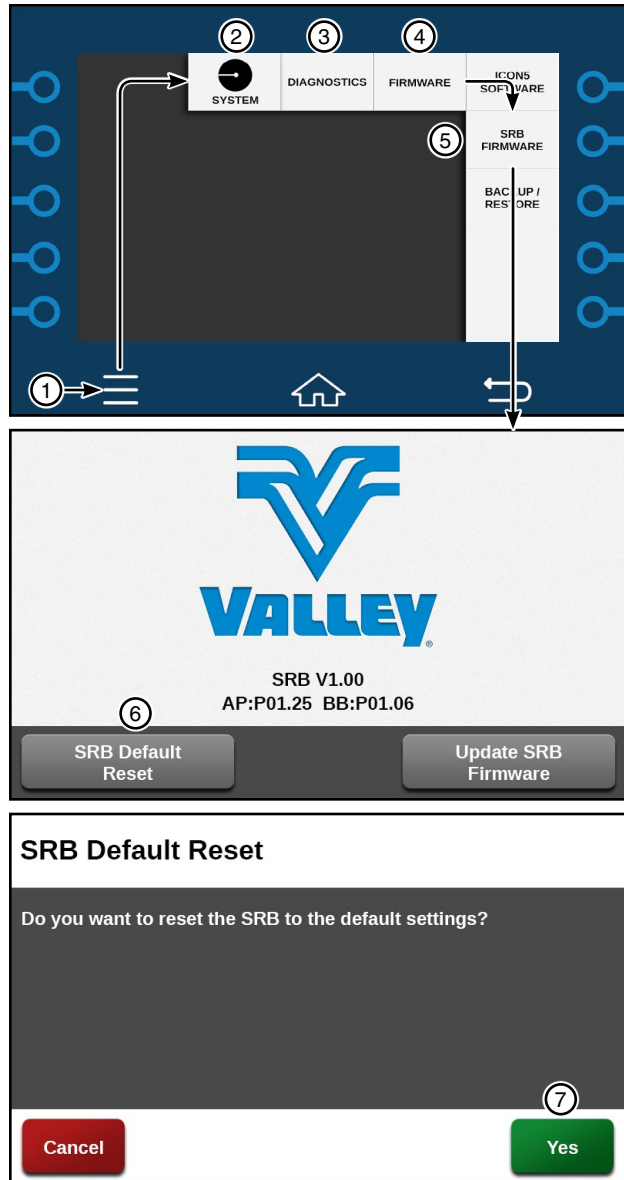

Figure 84-1 1. Menu 2. System 3. Diagnostics 4. Firmware 5. SRB Firmware 6. SRB Default Reset 7. Yes

Smart Relay Board Update SRB Firmware

Updating SRB Firmware, uploads the most current version of firmware and preserves panel settings.

Refer to Figure 85-1 and do the following to Update SRB Firmware.

1. Insert USB flash drive into USB port located on the front of the panel.
2. Push **Menu**, **System**, **Diagnostics**, **Firmware**, and **SRB Firmware**.
3. Push **Update SRB Firmware**.
4. Push **Yes** to start the update process.
5. Push **Read USB**.

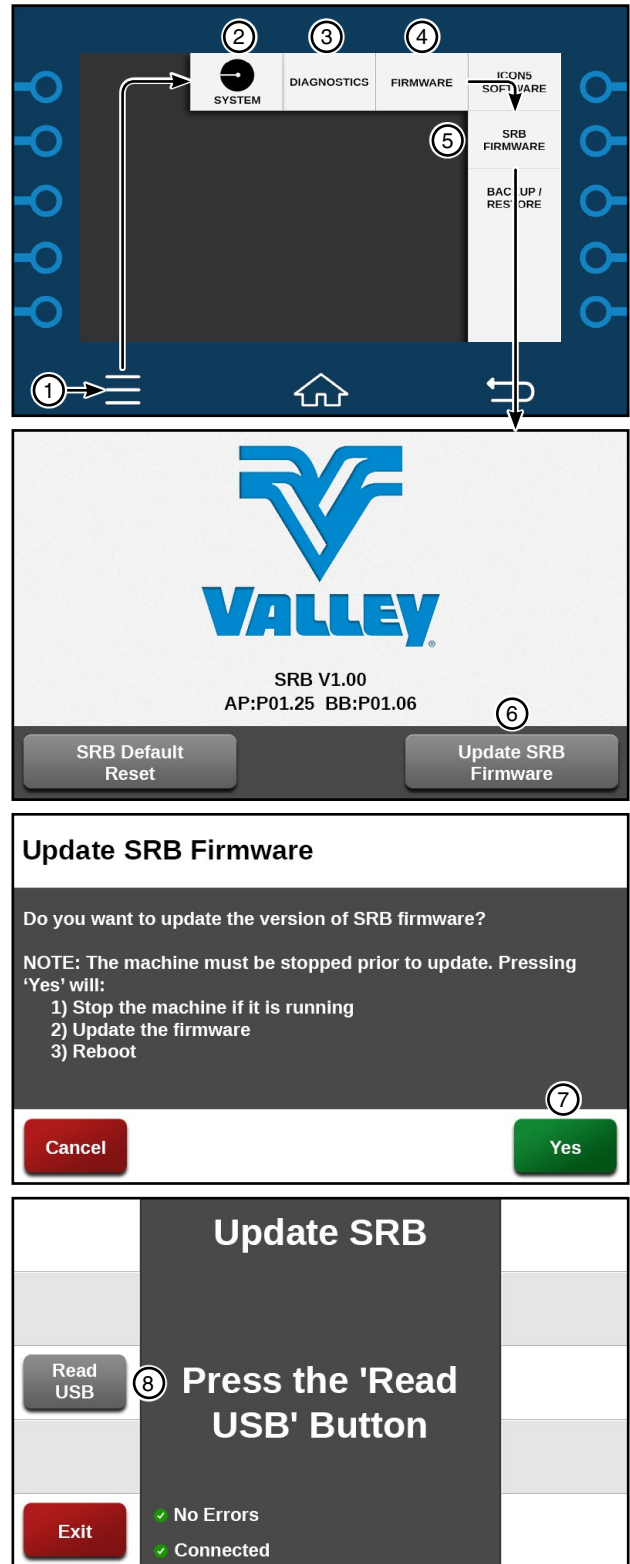

Figure 85-1

1. Menu	5. SRB Firmware
2. System	6. Update SRB Firmware
3. Diagnostics	7. Yes
4. Firmware	8. Read USB

Troubleshooting

Smart Relay Board

Update SRB Firmware (continued)

6. Select desired file from the files found.
7. Push **Program File** to update the firmware.
The control panel will update the SRB Firmware and then automatically reboot.
8. After the SRB Firmware update completes, the USB flash drive can be removed.

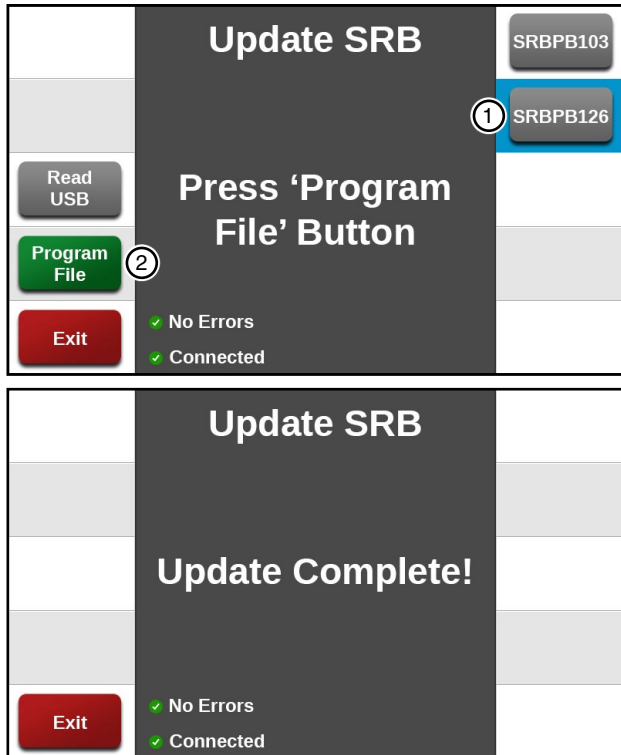

Figure 86-1 1. Select File
2. Program File

Smart Relay Board Backup Panel Settings

The Backup / Restore screen, allows the user to create and restore panel settings. Each of the files create restore points to load at a later date.

- Saves current statuses
- Saves all current constants
- Saves all options
- Saves all current and stored programs
- Saves Review History
- Saves Error Log history

To create a Backup File, refer to Figure 87-1 and do the following:

1. Insert USB flash drive into USB port located on the front of the panel.
2. Push **Menu**, **System**, **Diagnostics**, **Firmware** and **Backup / Restore**.
3. Push **Backup Panel Settings**.
4. Push **Yes** to create a backup file.
5. Push **Name File** to open the keypad (keypad not shown).

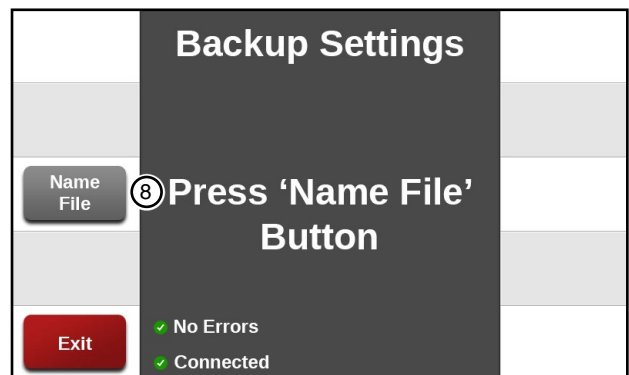
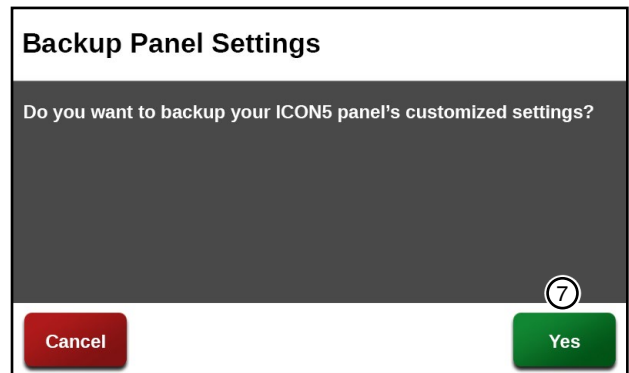
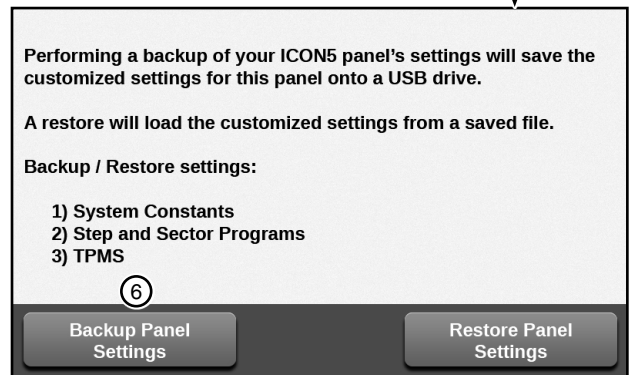
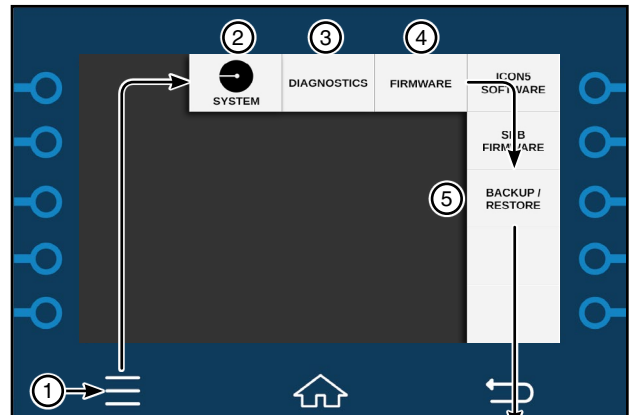

Figure 87-1

1. Menu	6. Backup Panel Settings
2. System	7. Yes
3. Diagnostics	8. Name File
4. Firmware	9. Named Backup File
5. Backup/Restore	10. Backup File

Troubleshooting

Smart Relay Board

Backup Panel Settings (continued)

6. Enter the file name, The file name can be one to eight characters long.
7. Push **Enter** and the named backup file appears on the screen.
8. Push **Backup File** to save the backup file to the USB flash drive.
9. After the backup file is saved, the USB flash drive can be removed.

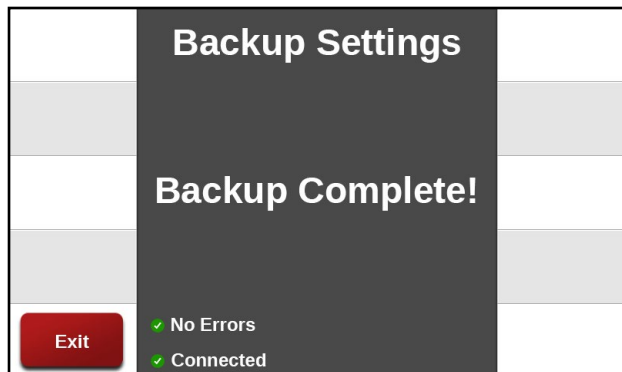
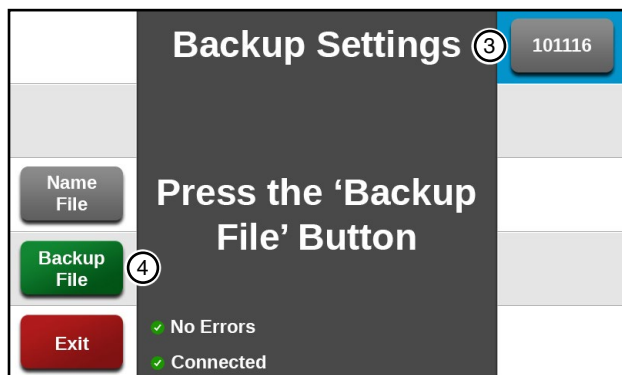
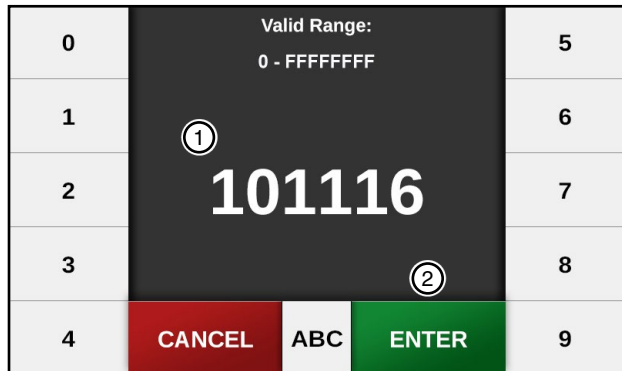

Figure 88-1 1. Enter File Name 2. Enter 3. Named Backup File 4. Backup File

Smart Relay Board Restore Panel Settings

The Restore screen, allows the user to choose a file containing saved panel settings, Step and Sector programs, and TPMS. A restore will load the customized settings from a saved file.

- Restores all System Constants
- Restores all Step and Sector Program settings
- Restores all TPMS settings

To restore a Backup File, refer to Figure 89-1 and do the following:

1. Insert USB flash drive into USB port located on the front of the panel.
2. Push **Menu**, **System**, **Diagnostics**, **Firmware** and **Backup/Restore**.
3. Push **Restore Panel Settings**.
4. Push **Yes**.
5. Push **Read USB**.

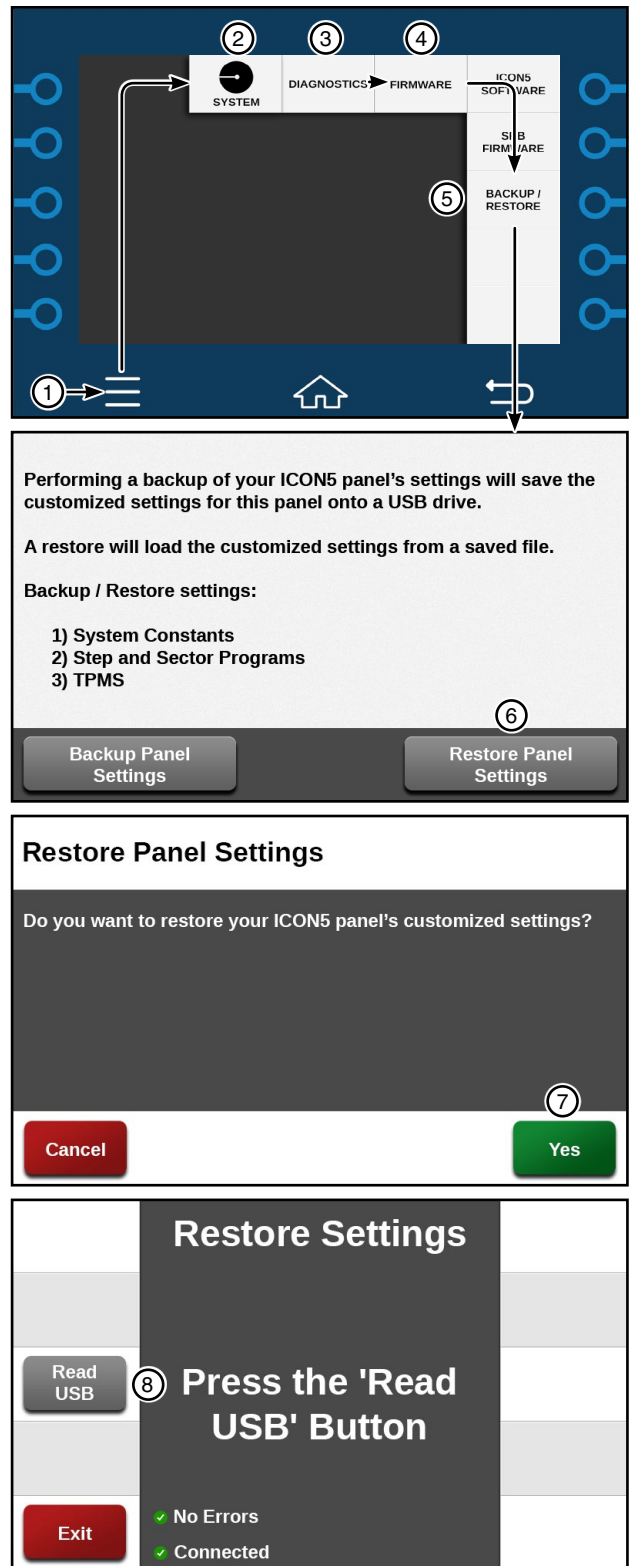

Figure 89-1

1. Menu	5. Backup / Restore
2. System	6. Restore Panel Settings
3. Diagnostics	7. Yes
4. Firmware	8. Read USB

Troubleshooting

Smart Relay Board

Restore Panel Settings (continued)

6. Select the file to be restored.
7. Push **Restore File** to restore the selected file from the USB flash drive.
8. After the file is restored, the USB flash drive can be removed.

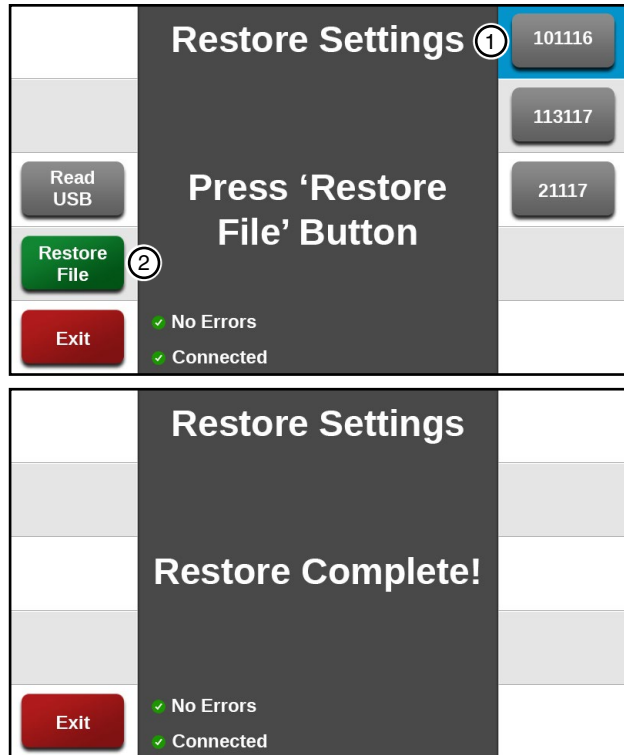

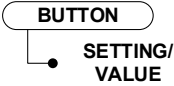
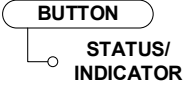
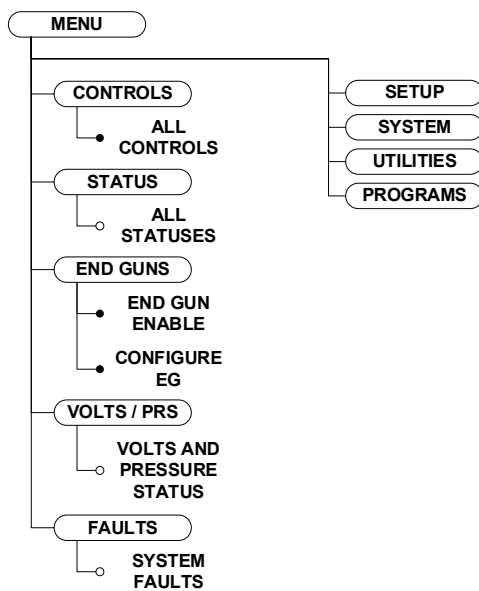

Figure 90-1 1. Select File
2. Restore File

The following flowcharts are provided to help you navigate to settings, values, statuses, indicators and the advanced features, associated with the Menu, Setup, System, Utilities and Program buttons.

Key:	Rounded Rectangles indicate Buttons used for menu navigation.	
	Closed Bullets indicate User Input Settings and Values.	
	Open Bullets indicate View Only Status and Status Indicators.	

Menu Button



Navigation

Setup Button

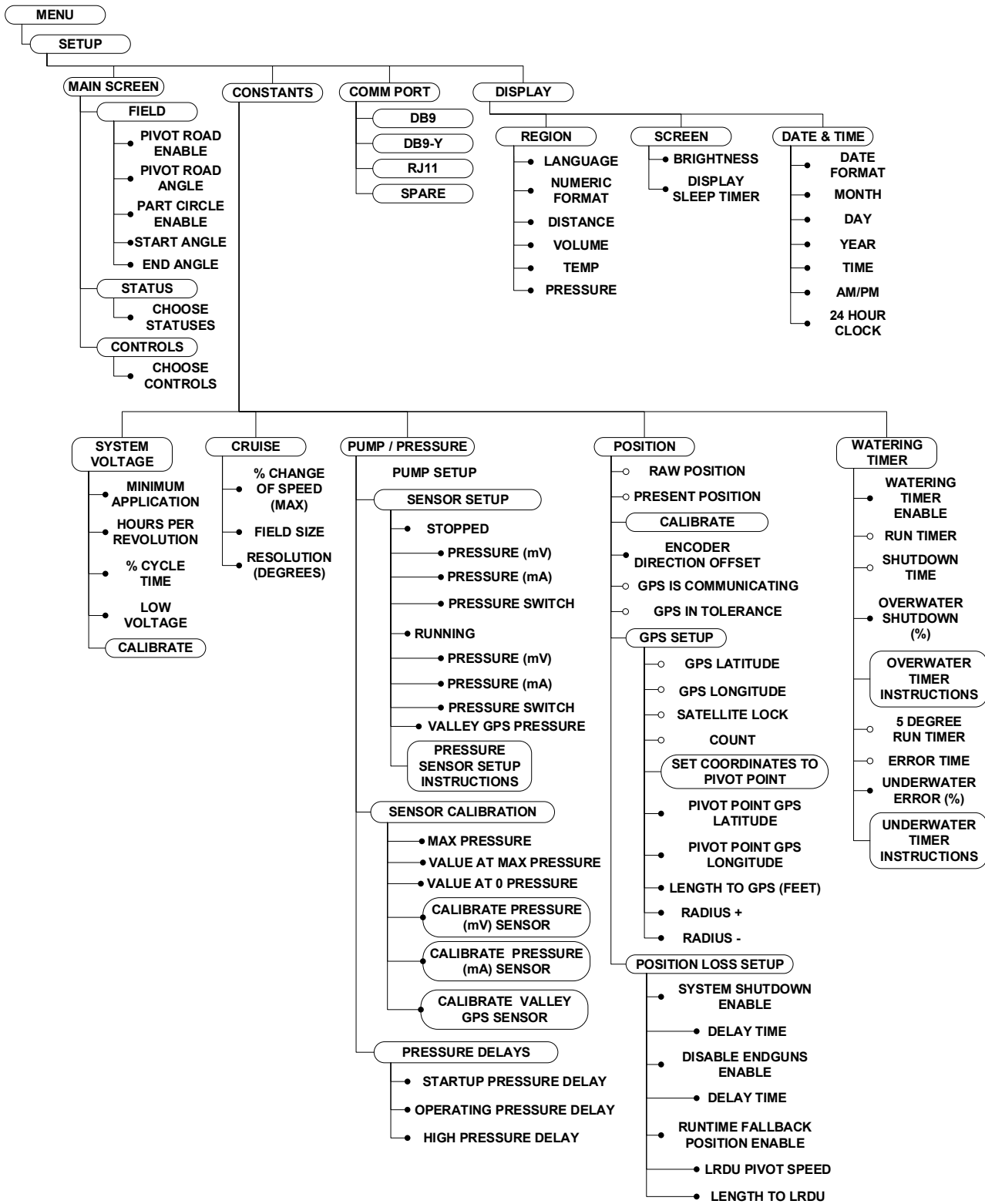

System Button

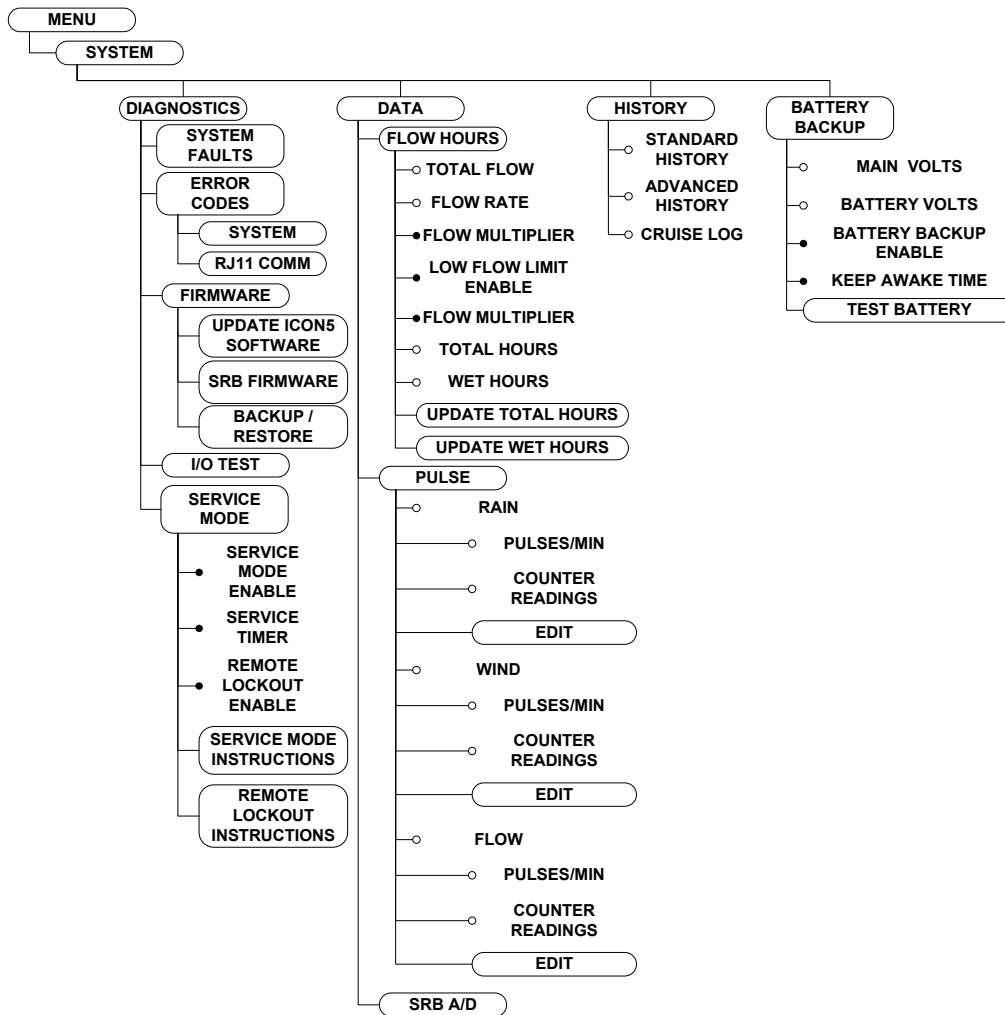

Navigation

Utilities Button

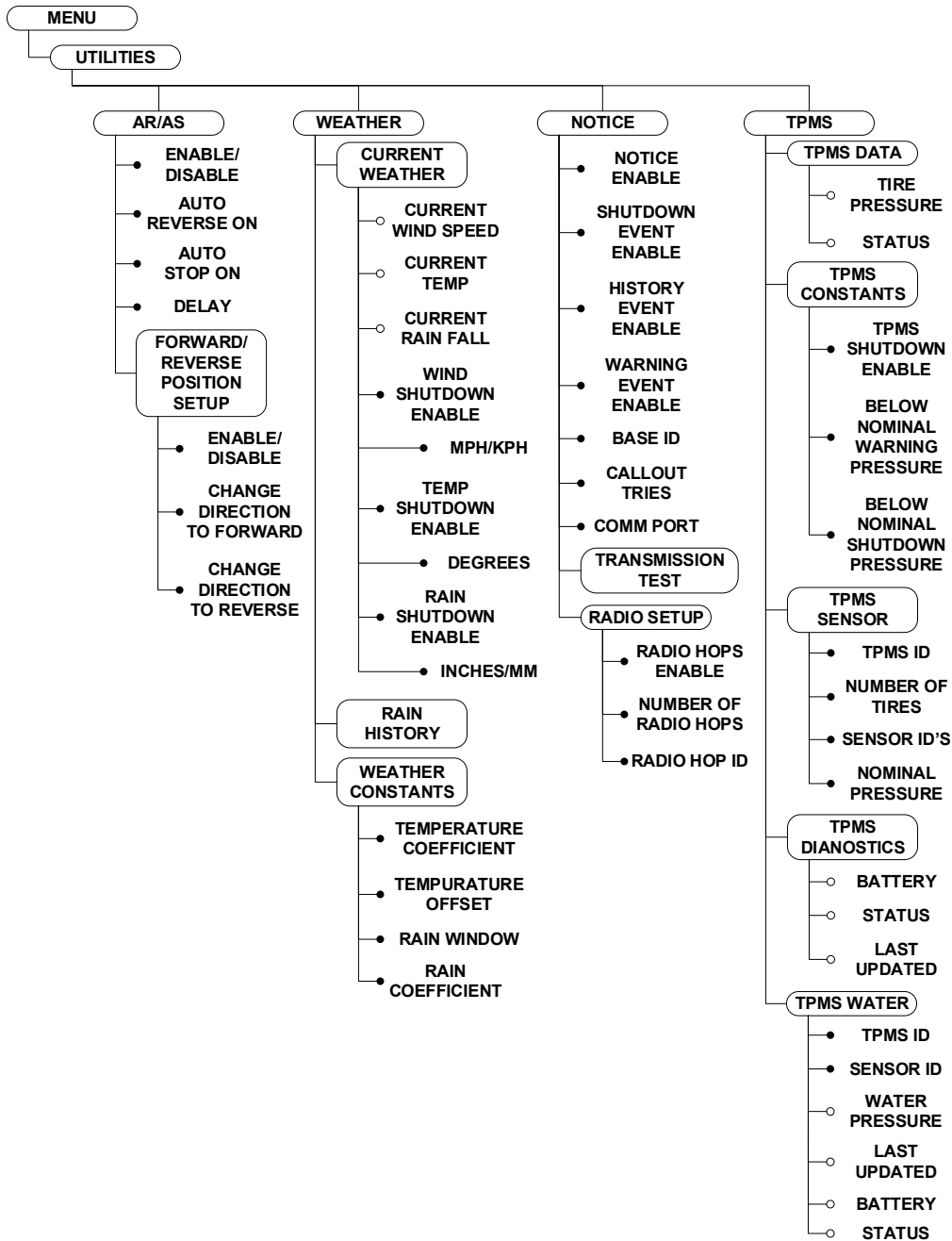

Programs Button

