

**cams SELECT
CONTROL PANEL**

OWNERS MANUAL

0994466_F

Specifications, descriptions and illustrative material contained herein were as accurate as known at the time this publication was approved for printing.

Valmont Industries Inc., reserves the right to change specification or design without incurring obligation. Specifications are applicable to systems sold in the United States and may vary outside the U.S.

QUICK REFERENCE GUIDE

TO RUN THE MACHINE:

(Refer to Section III for a detailed explanation)



1. Place the Engine RUN/START switch in the START position (if engine is being utilized).

2. Start the pump if it is not wired to start automatically and pressurize the machine slowly. (Delete this step if running without water.)



3. Select WATER ON or WATER OFF (if running without water).

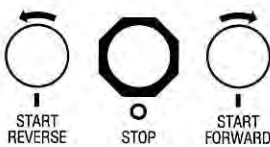

4. Press the FORWARD or REVERSE Start button.

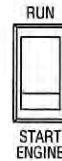

5. Place the Engine RUN/START switch in the RUN position. (If engine is being utilized.)

6. Select the Water Application amount with the Application Depth knob. If Water Off has been selected, set the percent timer setting with this knob.



Turn clockwise to increase water application. Turn counter-clockwise to decrease.

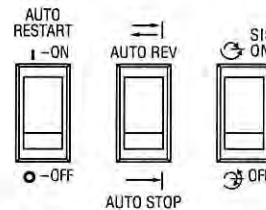

7. Select the desired settings for Auto Restart, Auto Reverse/Auto Stop and Stop In Slot.



8. To Stop, Press STOP.

A TYPICAL DISPLAY SCREEN MAY LOOK LIKE THIS:

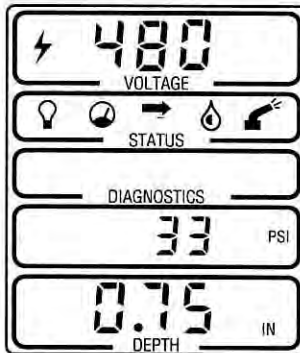

Press SELECT each time to display one of the following pieces of information:

- VOLTAGE
- MACHINE IS RUNNING
- WATER PRESSURE IS SUFFICIENT (ABOVE THE LOW PRESSURE SETTING). IF FLASHING, THE MACHINE IS WAITING FOR WATER PRESSURE.
- MACHINE IS RUNNING IN THE FORWARD DIRECTION
- WATER ON IS SELECTED
- END GUN IS TURNED ON
- DIAGNOSTICS DISPLAY IS BLANK INDICATING EVERYTHING IS OK
- WATER PRESSURE IN THE MACHINE IS 33 PSI.
- MACHINE IS APPLYING 0.75 INCHES OF WATER
- PSI or KPa PRESSURE
- HOURS WET
- % PERCENT TIMER
- TOTAL HOURS
- HOURS PER REVOLUTION
- MACHINE POSITION

DISPLAY SCREEN DESCRIPTION

- Incoming voltage is 480 volts
- Machine is running
- Water pressure is sufficient (above the low pressure setting). If flashing, the machine is waiting for water pressure.
- Machine is running in the forward direction
- Water On is selected
- End gun is turned on
- Diagnostics display is blank indicating everything is OK
- Water pressure in the machine is 33 psi.
- Machine is applying 0.75 inches of water

- FLASHING** Water Pressure symbol indicates a waiting period for water pressure. The machine will not move until sufficient water pressure is developed. (page 48)
- FLASHING "dELAY"** indicates the machine will restart after the delay period has timed out. The delay period for power auto restart can be set from 0-99 minutes. (page 32)
- FLASHING** Water On symbol indicates the machine is watering in place (not moving) at the auto reverse or auto stop points. (page 40)
- FLASHING** indicates all programmed areas have been turned off. Access SETUP Group 2 to enable the program feature again. (page 26)

DIAGNOSTICS SCREEN

The cause of a shutdown will be indicated by one of these symbols in the DIAGNOSTICS Screen. A blank screen indicates everything is operating correctly – NO PROBLEMS. Refer to page 33 for a detailed explanation of the diagnostics symbols.



Power Fault – Power failure or low voltage.

Low Pressure Fault – Pressure fell below low pressure setpoint.

Command Fault – Machine has been commanded off. (Flashes if there is a control panel problem).

Safety Fault – Machine safety circuit is incomplete.

SIS Fault – Stop-In-Slot position shutdown.

SETUP

The SETUP button is used to enter values which are unique to the machine and must be entered when the panel is first installed. Some of the values may need to be changed after the initial setting. Flashing descriptions of the value will be displayed indicating which value you are reviewing/editing.

1. Press for 2 seconds and release to access SETUP Group 1. Press for 4, 6, or 8 seconds and release to access SETUP Groups 2, 3 and 4 respectively.

3. Pressing SETUP while setting values in any group, returns the operator to the normal operating mode and saves the value if changed.

2. Pressing SELECT advances to the next value in each group.

The words "on" and "OFF" will be displayed here for values such as end gun and programmed area settings.

Values will be displayed here.

Application Depth knob used to adjust values. Press SELECT to save the change and advance to the next value. If no change is required, simply press SELECT.

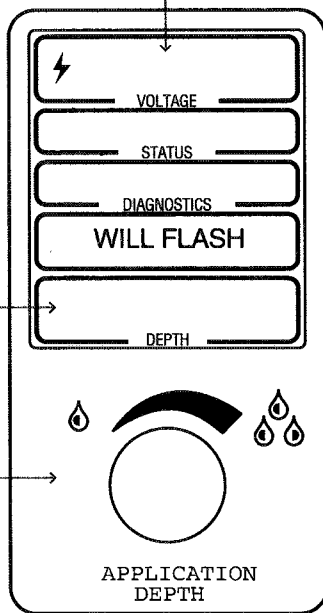

- SETUP GROUP 1** – Press SETUP for 2 seconds and release.
- S - I - S** Stop In Slot setting in degrees. (page 14)
 - POS** Current position of the machine in degrees. (page 14)
 - 1E9 - 1** End gun setting sequence #1. If there are no on/off angles set, the top screen will be blank. If angles are set, "on" or "OFF" will be displayed in the top voltage screen. The degree setting of the on/off angle will be displayed in the bottom screen. (pages 15-18)
 - 2E9 - 1** Sector Control setting sequence #1. Same procedure as end gun settings. (pages 18-22)
- SETUP GROUP 2** – Press SETUP for 4 seconds and release.
- Prog** Programming feature can be turned on/off. "On" or "OFF" will be displayed in top screen.
 - P r 1** Indicates Program Area #1. Six different areas can be programmed. The on (start) and OFF (stop) angles must be set for each area. The water on/off mode must also be set as well as the speed/water application depth. (pages 22-30)
- SETUP GROUP 3** – Press SETUP for 6 seconds and release.
- L o P S I** Low pressure shutdown point (PSI or KPa). (page 30)
 - d E L A Y** Pressure delay in minutes. (page 31)
 - r S D L Y** Amount of time delay (in minutes) before the machine will restart after power restoration. (page 31-32)
 - P E r** Percent timer cycle can be set at 30, 60 or 120 minutes. (pages 32-33)

SETUP GROUP 4 – Press SETUP for 8 seconds and release.

Includes the following:	Page	Page	Page
L o A P P Minimum (Low Application)	33	A r - A S Auto Reverse/Stop Enable	35
L o H r Minimum Hours Per Revolution	33	F P O S Forward Position	37
[R L Voltage Calibration	34	r P O S Reverse Position	37
L o ⚡ Low Voltage Setting	34	A r d L Y Auto Reverse/Stop Delay Period	39
		D F F S ° Direction Offset	40
		E n g Engine Control On/Off	41
		English or Metric Units	41
		b A u d Baud Rate	42
		P A S S Password	42

DECLARATION OF CONFORMITY

in accordance to ISO/IEC 17050-1:2004

NO. 001-2005

Manufacturer Name: Valmont Industries Inc.
Manufacturer Address: 7002 North 288th Street,
PO Box 358
Valley Nebraska 68064-0358

declares that the product:

Product Name: Select Control Panel
Model Numbers: 8000
8120

conform to the following EC standards:

EN-292 Safety of Machinery
EN-60204-1 Safety of Machinery
EN-909 Safety, Irrigation Machinery

Supplementary Information:

The product herewith complies with the requirements of the following EC directives and carry the CE marking accordingly.

Machinery **98/37/EC**
Low Voltage **73/23/EEC**
Electromagnetic Compatibility **89/336/EC**

The product also complies with the following articles, codes and standards:

National Electrical Code	240 Overcurrent protection 250 Grounding 310 Conductors for general wiring 430 Motors, motor circuits and controllers
Canadian Electrical Code	C22.1-1990 Safety standards for electrical installations
ANSI/ASAE Standard	S362 Wiring and equipment for electrically driven or controlled irrigation machine. S397.2 Electrical service and equipment for irrigation.

Signed _____

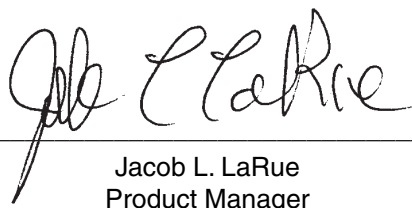
Jacob L. LaRue
Product Manager

Date Issued April 22, 2005

ELECTRICAL SAFETY STATEMENT

INSTALLATION OF THE VALLEY ELECTRIC IRRIGATION MACHINE

Valmont Industries Inc. does not install a differential (ground fault) circuit breaker in the control panel of the Valley electric irrigation machine because the standards of protection vary according to country of destination. The distributor must provide and install a differential (ground fault) circuit breaker that meets the standards of the country where the Valley irrigation machine is installed.

In the European Union, differential circuit breaker protection is fixed at a maximum of 24 volts.

Good grounding of the Valley irrigation machine is required.

- If resistance to ground is lower than 80 ohms, a differential (ground fault) circuit breaker of 300mA will meet requirements.
- If resistance to ground is between 80 and 800 ohms, a differential (ground fault) circuit breaker of 30mA will meet requirements.

The power supply installation and inspection of equipment protection components or systems are the responsibility of the installer. Valmont Industries Inc. is not responsible for the failure of equipment protection components or systems not of their manufacture.

Valley pivot irrigation machines receiving power from a generator must have a cable connected from the irrigation machine structure to a ground rod and another cable from the irrigation machine structure to the ground terminal on generator in order for the differential (ground fault) circuit breaker to work.

Valley linear irrigation machines equipped with a generator are not equipped with a ground rod but must have a cable connected from the linear irrigation machine structure to the ground terminal of the generator in order for the differential (ground fault) circuit breaker to work.

- The resistance between the irrigation machine and the generator must be substantially below 80 ohms.

SAFETY

The Valley center pivot irrigation system is designed with electrical and mechanical safety in mind. However, if this machine is operated incorrectly, it may pose a safety threat to the operator.

A good safety program is much like a chain. It is only as strong as its weakest link. The manufacturer, dealer and operator must maintain and improve all safety programs.

Following is a list of safety operating tips which you and all other persons servicing or operating the machine must first read and understand.

RECOGNIZE SAFETY INFORMATION

This is the safety alert symbol. If you see this symbol on your machine or in this manual, be alerted there is the potential for personal injury.



Read and follow recommended precautions and safe operating practices

SIGNAL WORDS

The following words:

- DANGER
- WARNING
- CAUTION

are used with the safety alert symbol to make the operator aware of potential hazards.

DANGER poses the most serious threat to the operator and in some conditions can lead to death if ignored.

DANGER or WARNING safety signs identify and locate specific hazards.

CAUTION safety signs list specific safety precaution instructions..

READ THE OWNER/OPERATORS MANUAL AND FOLLOW SAFETY INSTRUCTIONS

It is essential that you, maintenance personnel or any other operator of the system read and understand this manual before operating this equipment. Carefully read all safety messages in this manual and safety signs on the irrigation machine.

Do NOT let anyone operate this equipment without proper instructions.

Keep your machine in proper working condition. Unauthorized modifications may impair the function and/or safety of the machine.

If you do not understand any part of these safety guidelines or any other part of this manual and need further assistance, contact your Valley dealer.

PROPER GROUNDING

Do NOT attempt to start the system until the electrical service is properly installed and grounded by a qualified electrician as per the electrical standards.

As with any electrical machinery, if the power supplied to the center pivot is not grounded properly, severe injury or death can result should an electrical malfunction occur.

It is your responsibility to ensure that your power supplier and/or electrical contractor has grounded the irrigation system as required by the National Electrical Code and by applicable local electrical codes.

If a system is properly grounded and fuse sizing is correct, there is extremely low probability of an individual being injured by electrical shock.

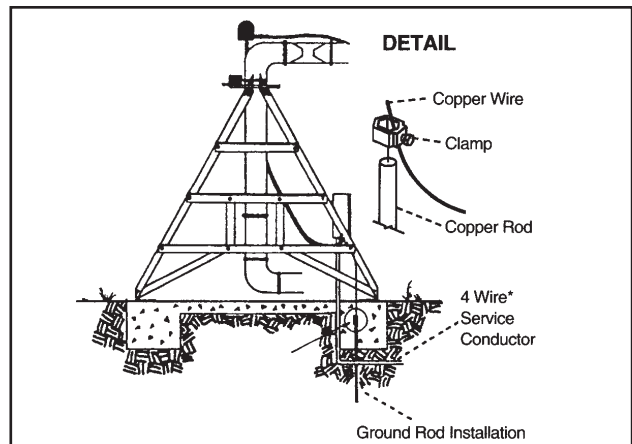

IMPORTANT: All 480 volt AC power supply services MUST be a 4 conductor service. Three 480 Volt AC power lines and one ground conductor which is as large as the power carrying conductors for that service.

IMPORTANT: Each time a towable system is moved, the ground wire MUST be re-attached to the ground rod and checked for electrical integrity before restarting the machine.

Valley Select Control Panel

⚠ DISCONNECT POWER WHEN SERVICING
ALWAYS disconnect electrical power before servicing or performing maintenance to the machine.

If you are going to perform maintenance to the machine, YOU MUST shut off and lock the main power disconnect as shown below.



The blue (OSHA safety color code) tag shown below should also be filled out and attached to the disconnect after locking.

The tag should reveal the name of a person to contact before restoring power to the system.



⚠ DRIVE SHAFTS START WITHOUT WARNING
An electric motor on each tower of the center pivot powers two drive shafts connected to wheel gear drives. These drive shafts start and stop without warning.

The Danger decal illustrated below is placed on each drive tower to warn the operator of this Danger!

IMPORTANT: DRIVE SHAFT SHIELDS MUST ALWAYS BE IN PLACE WHEN OPERATING THE SYSTEM.

NEVER depress the override button longer than 3 to 5 seconds.

The operator MUST inspect the entire system between each start attempt.

Repeated override start attempts can cause severe structural damage.

Call the local Valley dealer should the system fail to start.

⚠ DO NOT OVERSIZE FUSES
Fuses are sized for the protection of a specific machine.

Be certain you have the proper fuse sizes in place before initial start-up and when replacing fuses.

⚠ PROPER USE OF THE SAFETY OVERRIDE
Caution MUST be taken by the operator when this button is depressed as it will by-pass or disable all of the system's automatic safety shutdown circuits.

NEVER depress this button for more than 3 to 5 seconds. If the system is not in full view by the operator, do not use the Safety Override switch.

⚠ LIGHTNING AND YOUR MACHINE
Stay away from the machine during an electrical storm.

The center pivot makes a good path to earth. It is also probably the tallest object in the field, which makes it a good lightning receptor!

⚠ CHECK WHEEL TRACKS BEFORE STARTING

Make sure all objects, livestock or persons are clear of the system before starting.

Center pivot drive trains are powerful and can climb over vehicles, equipment, etc.

⚠ AVOID CHEMICALS

Avoid exposure to system spray while chemicals are being injected into the water.

If you plan on chemigating, make certain you have complied with state or local regulations in regard to safety equipment, certification, operation and calibration of the injector pump.

Make certain you have first aid and fresh water available in case of an accident.

You must also be familiar with the correct clean up procedures in case of a spill.

Use of protective clothing is recommended when handling chemicals. Safety glasses, gloves and protective outerwear should be available.

Contamination of the water supply may occur if effective safety devices are not installed/used in connection with injection equipment for chemigation.

Read EPA Label Improvement Program (PR Notice 87-1) and all instructions for chemical applications.

⚠ KEEP CHILDREN AWAY

Center pivots are NOT playground equipment.

Prevent children from playing or climbing around on the machine. This can be extremely dangerous, especially if the machine is operating.

AVOID HIGH PRESSURE WATER STREAMS Avoid body contact with high pressure water streams, such as end guns.

DO NOT crawl out on system overhangs to service end guns. The added weight of your body to the overhang may cause serious injury if it fails or you fall.

Do not attempt to adjust an end gun as it operates.

⚠ SUSPECTED SHORT CIRCUITS

If you suspect a short circuit due to a “rippling tingle”, **DO NOT** touch the machine again. Call a qualified electrician or an authorized Valley dealer immediately.

⚠ DO NOT OPERATE AT FREEZING TEMPERATURES

Spraying water has a cooling effect and water will freeze even though the air temperature is slightly above freezing.

Shut the system down at 40 degrees Fahrenheit (4.5 degrees Celsius).

Do not operate system when temperature is below 40°F (4.5C).

Read and understand the Valley operator manual before operating this equipment.

Your Valley system is **NOT** equipped with a cold weather shut-off!

Cold weather shut-off controls are available from other vendor sources which will cause system shutdown when the air temperature reaches 40 F.

Installation of these types of shut down controls should not take the place of regular checks by the operator when the system must operate during marginally cold weather (40-50 F).

Damage to equipment resulting from freeze-up is **NOT** covered under warranty.

It is important to make sure all pipe drains function properly to prevent pipe line freeze-up during cold weather.

⚠ CHECK SYSTEM DIRECTION WHEN OPERATING

DO NOT operate the system if it moves in the direction opposite to that which was chosen.

Forward should be clockwise and reverse counter-clockwise. **FORWARD**
(**REVERSE**

⚠ PLUG - IN CONNECTORS

Disconnect power before connecting or disconnecting any plug-in connectors.

⚠ TOWING SAFETY

Avoid ditches, rough terrain, overhead power lines, etc. when towing a system from field to field.

The ground wire **MUST** be re-attached to the ground rod and checked for electrical integrity each time the system is towed and before restarting the system.

⚠ QUALIFIED SERVICE PERSONNEL

If you do not understand electricity or other parts of the system, have qualified service personnel perform any hazardous repairs or maintenance.

Do **NOT** deep rip or chisel near the buried power service wires.

Do **NOT** deep rip in a circle at the drive unit. The deep chisel track will cause severe stresses on the structure.

If you do deep rip your field, run the system at full speed for the first revolution.

Replace any guards and shields removed for maintenance.

DO NOT touch the system if you suspect a short-circuit situation.

Circumstances which may cause you to suspect hazardous voltage situations may include:

- . Physical damage to the machine or span cable
- . Recent electrical storms (lightning)
- . Unusual operating characteristics of the system

⚠ PART CIRCLE OPERATION SAFETY

If your system reverses direction at a roadway or a physical object such as a building, tree line, etc., then you **MUST** provide some backup device to stop the system if the reversing mechanism were to fail.

Contact your Valley dealer for more information concerning physical barricades for machines under these circumstances.

Drive Unit Mounted
Auto Reverse/Auto Stop Option

⚠ EMPLOYEE INSTRUCTION ON SAFETY

It is Very Important to instruct your employees on the safe use of this equipment at the time of their initial assignment to operate it.

Safety training should be presented annually and the owner/operator should ensure employees fully understand the safety messages and what to do in case of emergencies.

⚠ KEEP WATER OFF ROADWAYS

It is against the law in most states to allow water to spray on state and county roadways. This is a serious hazard to passing motorists.

If end guns are used, make sure you read and understand the correct procedures for setting the on and off positions to avoid watering the roadways.

If an end gun is watering a roadway, immediately discontinue use and adjust the shutoff setting or call your Valley dealer to repair the end gun shut off mechanism.

⚠ EMERGENCY STOPPING

The machine can be stopped at any time at any tower by turning the disconnect switch, located underneath the tower box, to the OFF position, .



SAFETY DECALS

These Danger, Warning and Caution decals appear in various locations on a Valley irrigation machine. You **MUST** familiarize yourself and other operator's with these safety decals. For replacement of any decal, contact your local Valley dealer.

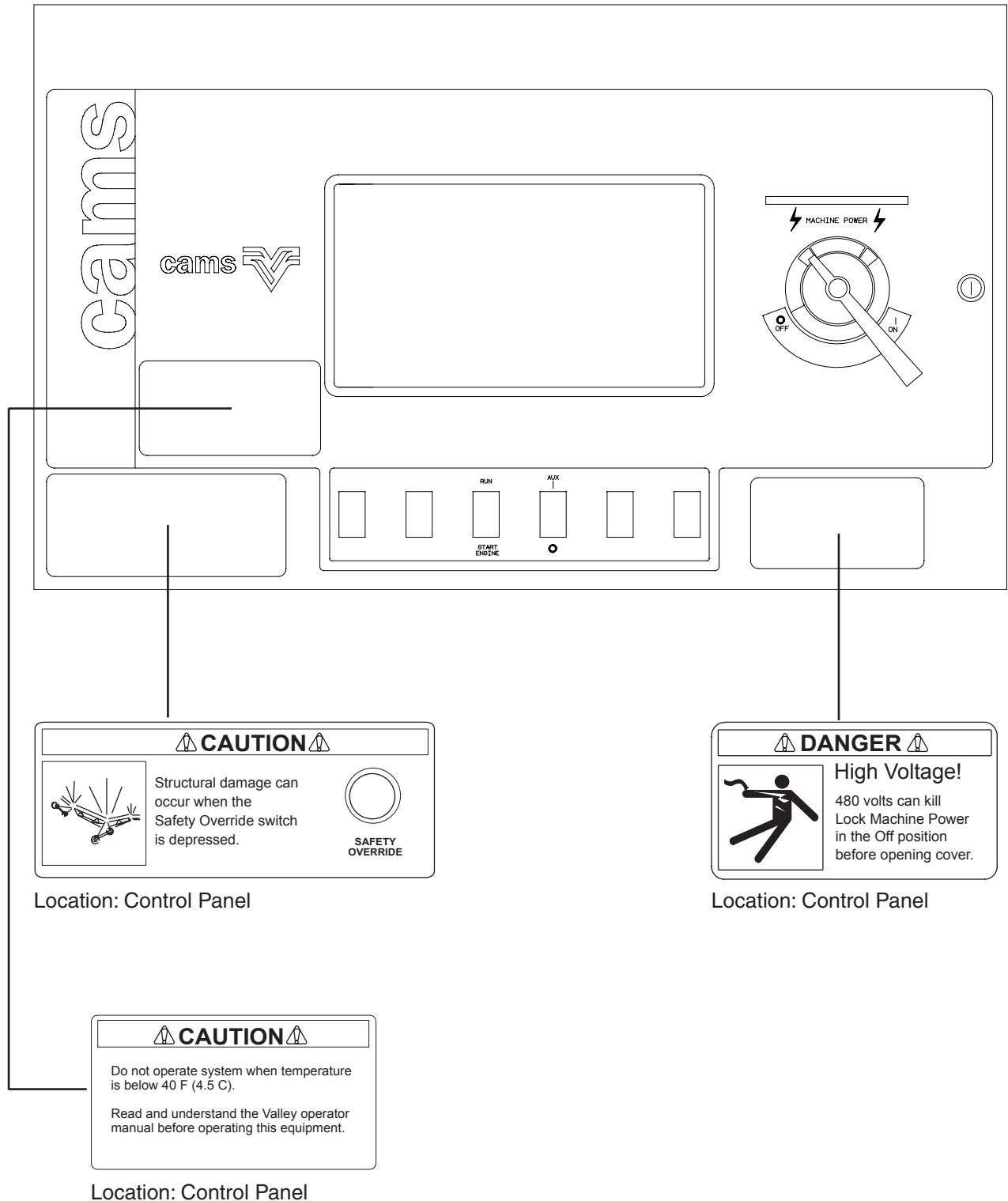

Valley Select Control Panel

⚠ DANGER

REPLACE LINE SHIELDS AFTER WIRING.

IMPROPER INSTALLATION WIRING OF THIS IRRIGATION MACHINE MAY CAUSE INJURY TO PERSONNEL OR EQUIPMENT FAILURE. THIS IRRIGATION MACHINE MUST BE CONNECTED TO A FOUR WIRE GROUNDED ELECTRICAL SERVICE. THIS IRRIGATION MACHINE MUST BE GROUNDED AS REQUIRED BY "THE NATIONAL ELECTRICAL CODE AND APPLICABLE LOCAL CODES. THE VALLEY OWNERS MANUAL CONTAINS THE STANDARD FOR ELECTRICAL SERVICE AND EQUIPMENT FOR IRRIGATION

Part No. 0315928
 Location: Electrical Panel Inside Control Panel

USE 60° C INSULATION COPPER WIRE ONLY FOR FIELD WIRING

Part No. 0994836
 Location: Electrical Panel Inside Control Panel

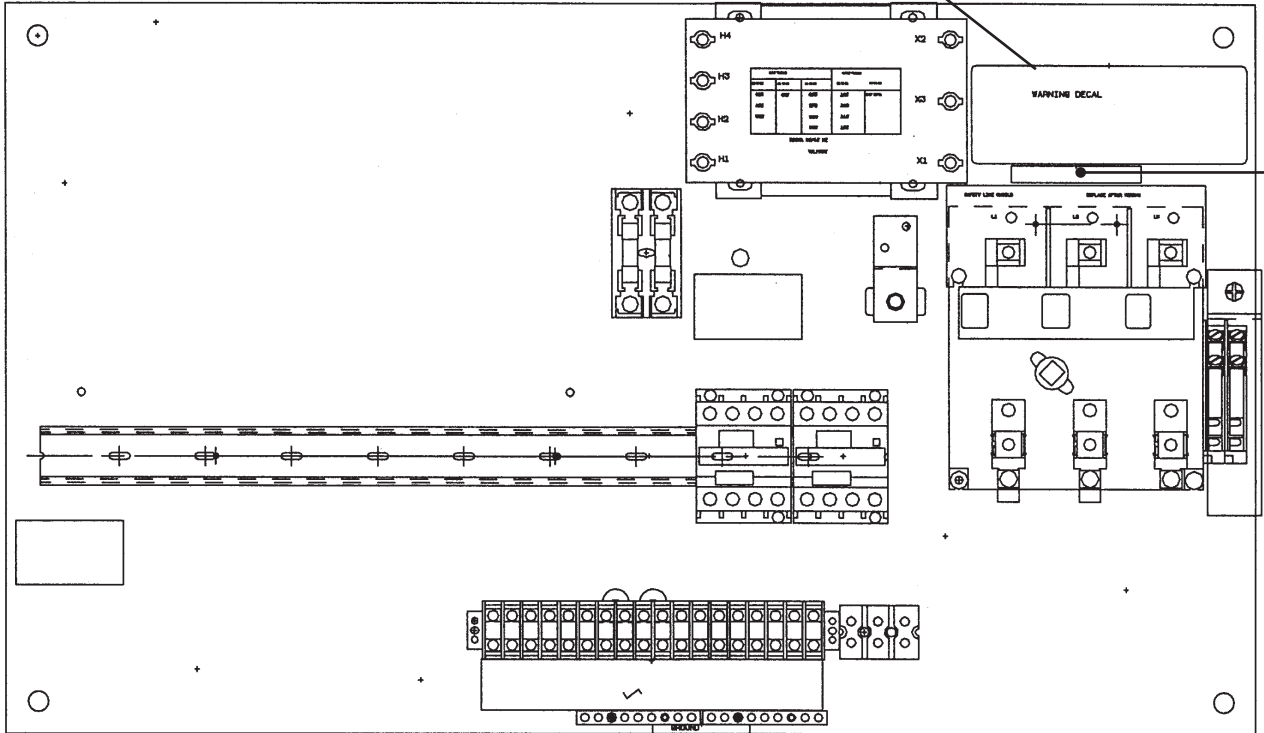

ABOUT THIS MANUAL

This manual covers the operation of the Valley Select Panel. You must also read “The Valley Pivot” Owners Manual. The guidelines in this manual are for using the Valley Select controls only. Sections related to safety, pivot hardware, maintenance, towing, troubleshooting, winterization and electrical standards are covered in “The Valley Pivot” Owners Manual. You should familiarize yourself with the capabilities of the machine in order to obtain the best performance. It should be remembered that the sprinkler will perform according to your knowledge of the equipment, soil and water relationships and equipment application concepts.

The four sections of the manual cover the following:

SECTION I - Select Panel Controls and Components

Explains the controls and components of the Valley Select Panel.

SECTION II - Select Panel Set Up

Explains how to enter characteristics about the machine. In this step, the operator is “customizing” the machine to the field. Examples of items entered would include pressure start up delays, low pressure shutdown settings, end gun settings, auto reverse points and changing water applications at different field locations.

SECTION 111- Operating Your Panel

Instructs the user in the basic operating procedures for the panel. Functions such as starting, stopping, changing direction and selecting the amount of water to be applied are covered.

SECTION IV - Diagnostics

Guides the user in utilizing the Diagnostics feature to assist in basic troubleshooting procedures.

Appendices A and B contain additional information you may be required to refer to. Forms, tables and procedures are listed in the appendices.

TABLE OF CONTENTS

QUICK REFERENCE GUIDE	I
DELCLARATION OF CONFORMITY	III
ELECTRICAL STATEMENT	IV
SAFETY	V
ABOUT THIS MANUAL	1

SECTION 1 - SELECT PANEL CONTROLS AND COMPONENTS

INTRODUCTION	3
DISPLAY SCREEN	3
-Voltage Display	4
-Run Status Display	4
-Diagnostics Display	4
-Multiple Information Display	4
-Water Application Display	6
MAIN DISCONNECT	6
SET UP	6
FORWARD AND REVERSE START	6
STOP	7
WATER ON/OFF	7
APPLICATION RATE	7
AUTO RESTART ON/OFF	8
AUTO REVERSE/STOP	8
STOP IN SLOT	10
OPTION SWITCHES	10
-Engine Run/Start	11
-Auxiliary On/Off	11
-Auto/Offrrest	11

SECTION 2 - SELECT PANEL SET UP

INTRODUCTION	12
USING SETUP - A QUICK OVERVIEW	12
SETUP GROUP 1	13
-Stop In Slot	14
-Current Position	14
-End Gun Settings (Setting for the First Time)	15
-Sector Control Settings (Setting for the First Time)	18
Example 1 - Irrigating a Wide Boundary with a Corner Machine	18
Example 2 - Controlling Two End Guns	19
Example 3 - Controlling Sprinklers with the Sector Control Settings	19
How to Input Sector Control Settings	20
SETUP GROUP 2	22
-Example 1: Changing Water Applications For Two Different Crops	22
-Example 2: Running A Pivot Dry (Without Water) Over A Specified Area	26
SETUP GROUP 3	30
-Low Pressure Setting	30
-Pressure Delay	31
-Power Restart Delay	31
-Percent Timer Cycle	32

SETUP GROUP 4	33
-Minimum (Low) Application	33
-Minimum Hours Per Revolution	33
-Voltage Calibration	34
-Low Voltage Setting	34
-Auto Reverse/Stop Enable	35
-Forward and Reverse Positions	37
-Auto Reverse/Stop Delay Period	39
-Direction Offset	40
-Engine Control	41
-English or Metric Units	41
-Baud Rate	42
-Password	42
REVIEWING AND EDITING VALUES	42
-Reviewing Values	42
-Changing Values	42
-Changing End Gun Settings	43
-Adding End Gun/Sector Control Settings	44
-Deleting End Gun/Sector Control Settings	45
-Changing, Adding and Deleting Programmed Commands in Setup Group 2	45
Making a Change	45
Adding a Programmed Area	46
Deleting a Programmed Area	47

SECTION 3 - SELECT PANEL OPERATION

STARTING THE MACHINE WET (WITH WATER)	48
STARTING THE MACHINE DRY (WITHOUT WATER)	49
STOPPING THE MACHINE	51
SAFETY OVERRIDE	51

SECTION 4 - DIAGNOSTICS

-Power Fault	52
-Low Pressure	52
-Command	2
-Equipment Safety	52
-Stop In Slot	52
-Other Error Messages	53

APPENDIX A

RECORD OF SETUP VALUES	55
TYPICAL END-GUN SETTINGS	56
END GUN SETTING OVERLAY	57

APPENDIX B

POSITION ACCURACY	59
DETERMINING THE APPROPRIATE DIRECTION OFFSET CONSTANT	59
-Estimated	59
-Calculated	60
CALCULATING THE DIRECTION OFFSET WORKSHEET	63

Section 1 - Select Panel Controls and Components

INTRODUCTION

This section is designed to acquaint you with the basic controls and features of the Valley Select Panel. Operating Commands are executed with rocker switches and push buttons. The LCD display screen indicates the status of the machine and the

cause of any unplanned shutdowns. Following is a description of each component and the display screen. Figure 1.1 provides a layout of the Select Panel and identifies its components.

Danger: 480 VOLTS – Do not open the interior control panel door. Electrical shock may occur. All needed controls and monitoring devices are on the outside of the interior control panel door. Service work done on the control panel is to be performed by a qualified service person only.

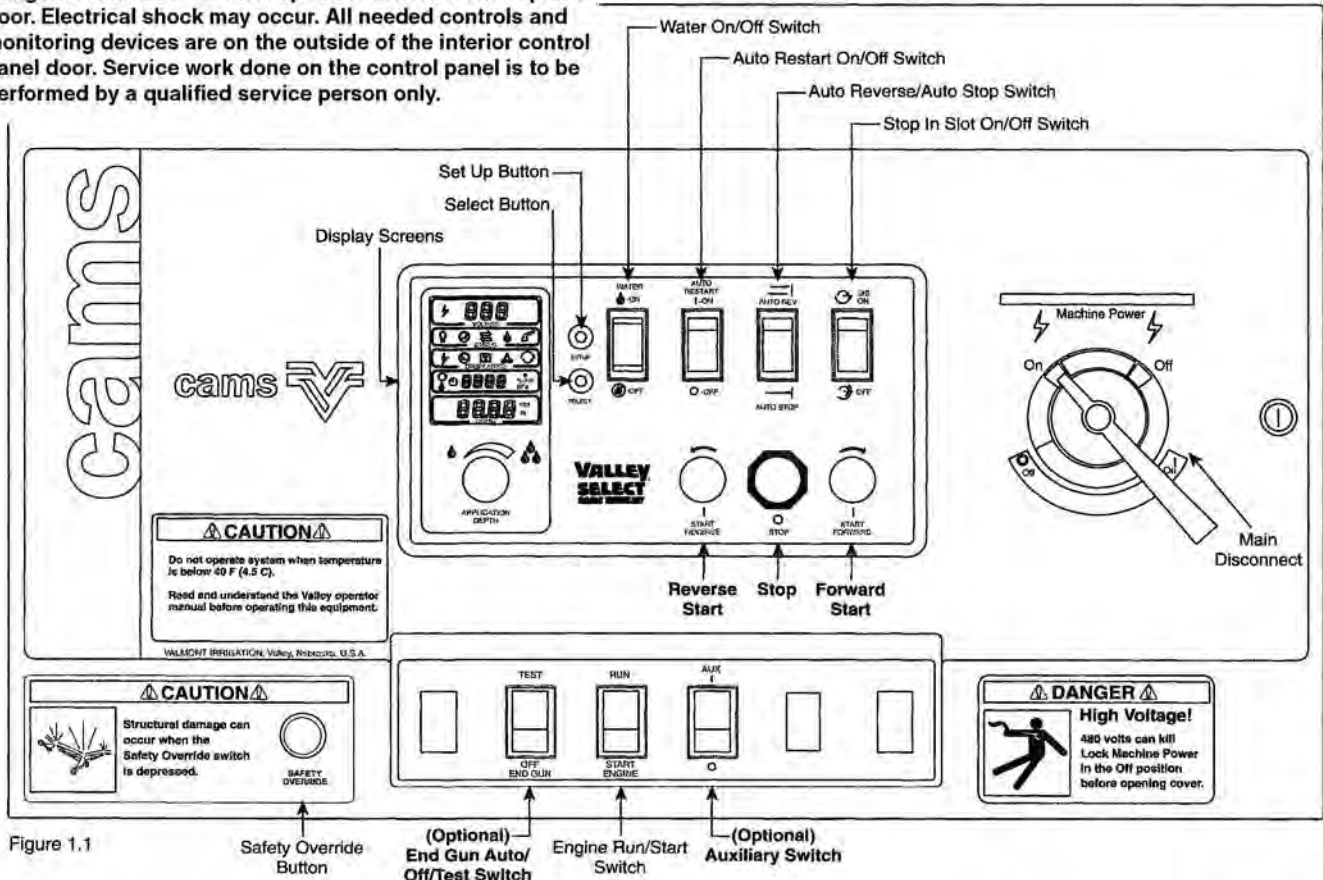

Figure 1.1

DISPLAY SCREEN

The LCD screen is divided into five separate areas where information is displayed. These areas are identified in Figure 1.2.

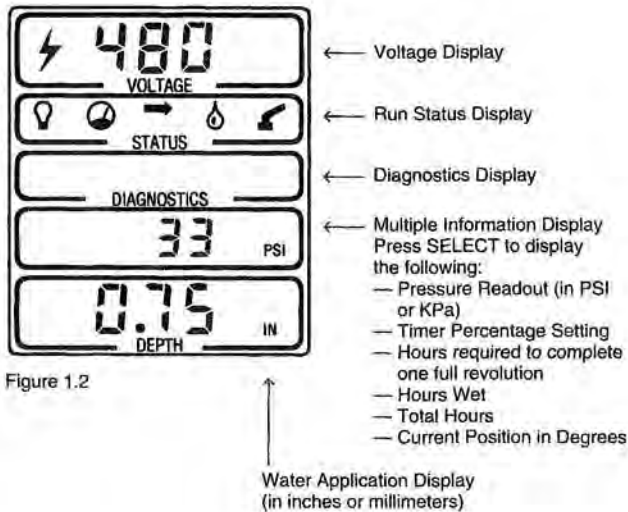

Figure 1.2

The screens in Figure 1.2 represent a normal running situation as described below:

- ⚡ Incoming voltage is 480 volts (⚡ indicates voltage)
- 💡 Machine is running
- 🌊 Water pressure is sufficient (above the low pressure setting)
- ➡ Machine is running in the forward direction (clockwise)
- 🔑 Water On is selected
- 🔑 End gun is turned on
- 📄 Diagnostics display is blank indicating everything is OK
- 📄 Water pressure in the machine is 33 psi
- 📄 Machine is applying 0.75 inches of water

The Multiple Information and Diagnostics Screens can also display other useful pieces of information not illustrated in figure 1.2. These will be explained in the following descriptions of each individual display screen.

Voltage Display

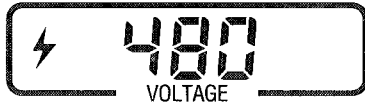

Figure 1.3

The current operating voltage at the control panel is displayed in the voltage display screen.

Run Status Display



Figure 1.4

The status screen informs the operator of the current running conditions of the machine.

Following is a list of the symbols (icons) which may appear and an explanation of what they mean.

- Machine is running. If the machine is off, this symbol will not appear.
- Indicates water pressure is sufficient (above the low pressure setting). This symbol will flash on and off when the Valley is first started to indicate it is waiting for water pressure. When the water pressure reaches the low pressure set point, the symbol will stop flashing.
- Your Valley is moving in the forward or clockwise direction.
- Your Valley is moving in the reverse or counter-clockwise direction.
- Water On has been selected. The machine will apply water by either opening a valve, starting a pump or by other means of supplying water. If Water Off has been selected, this symbol will not appear.
- End gun is turned on and applying water.

Diagnostics Display



Figure 1.5

An equipment shutdown will display one or more of the following symbols

to identify the cause of shutdown. Refer to Section IV "Diagnostics" for a complete explanation of the symbols.

Multiple Information Display

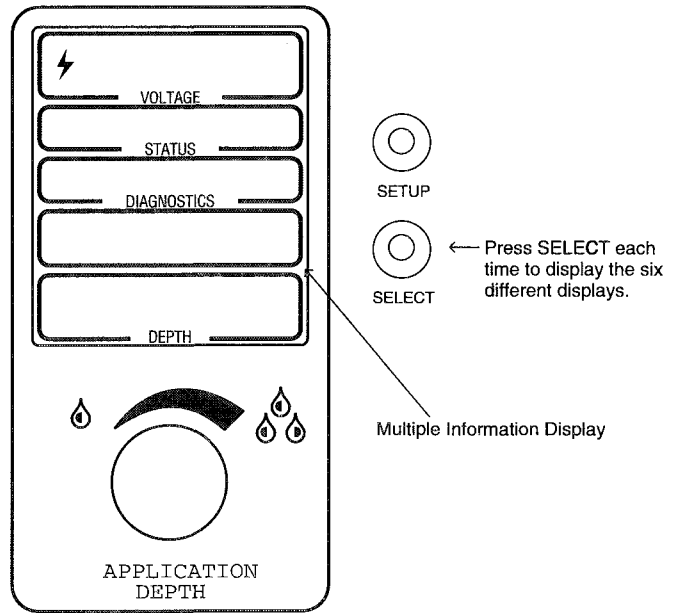

Figure 1.6

The SELECT button illustrated in figure 1.6 is positioned next to the fourth screen from the top and allows one of the following status reports to be displayed:

- Pressure Readout in PSI or KPa
- Percent Timer Setting
- Hours Per Revolution
- Hours Wet
- Total Hours
- Machine Position in Degrees

This information is displayed in the fourth screen by pressing the SELECT button. A different readout is displayed each time the SELECT button is depressed.

PRESSURE READOUT

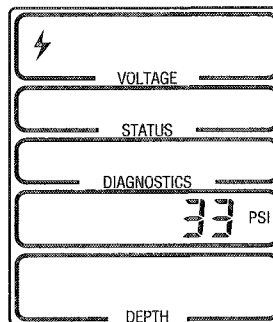

Figure 1.7

Indicates the water pressure in (PSI) pounds per square inch at the location of the pressure transducer (device which determines the pressure). This value can also be displayed in (KPa) kilopascals if the operator desires.

PERCENT TIMER SETTING

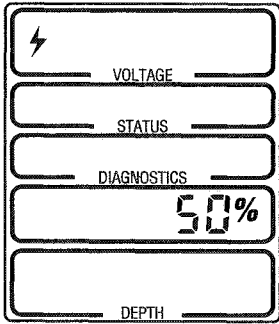

Figure 1.8

Displays the percent timer setting. Figure 1.8 indicates this machine is set at 50 percent. The end tower will run 50 percent of the time. If the cycle is set at one minute, the end tower would run 30 seconds out of each minute. (See the

section entitled "Percent Timer Cycle" included in Section 2 for more information on setting the percent timer cycle to a value other than the standard one minute).

HOURS WET

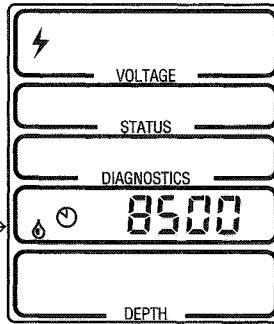

Figure 1.10

Displays hours the machine has run with water, in this case 8,500 hours. This value can be reset to 0 by pressing and holding the SELECT button more than 2 seconds while Hours Wet is displayed on the screen.

Symbol ID:

Indicates time or hours.

Indicates machine was running with water or "wet".

Displayed together, the two symbols indicate "Hours Wet".

HOURS PER REVOLUTION/CYCLE

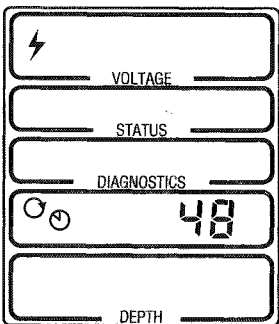

Figure 1.9

Displays the approximate hours required for the equipment to make one complete cycle. Figure 1.9 indicates that the equipment will make one complete cycle in approximately 48 hours. If the operator changes the application depth by turning the "Application Depth" knob, the hours per revolution display will change accordingly.

Symbol ID:

Indicates time or hours.

Indicates per revolution of the pivot.

Displayed together, the two symbols indicate "Hours Per Revolution".

NOTE: The value displayed is rounded to the nearest hour. Tenths of hours or minutes are a capability, but not displayed.

NOTE: The operator must also input a set up value in order for "Hours Per Revolution" to display correctly. The number of hours required to make a complete cycle or revolution at a percentage timer setting of 100% must be entered in Set Up Group 4. (Refer to Section 2 entitled "SELECT PANEL SET UP")

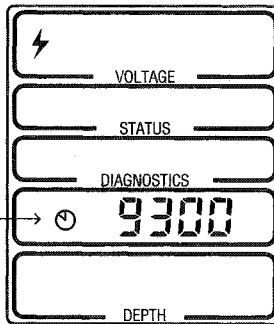

Figure 1.11

TOTAL HOURS

Displays total hours the machine has run, with and without water. This value can not be reset.

Symbol ID:

Indicates time or hours. When displayed by itself, indicates "Total Hours".

CURRENT POSITION

Displays the position of the pivot. In this example, the pivot is at 180 degrees clockwise from the field reference point. North is generally defined as the 0 degree reference point but any convenient location can be specified.

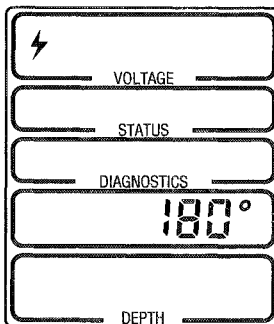

Figure 1.12

Water Application Display

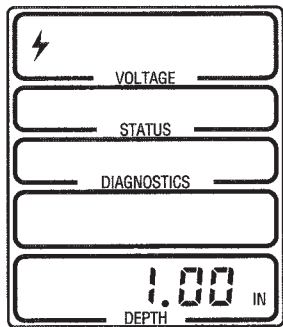

Figure 1.13

Always displays the amount of water being applied. 0.00 IN will be displayed if WATER OFF is selected. This value can also be displayed in millimeters if the operator desires.

← Water Application Display Screen (Displays the water application in inches or millimeters).

MAIN DISCONNECT

This switch disconnects all power to the Valley except at the incoming (upper) terminals on the Main Disconnect Switch inside the control panel.

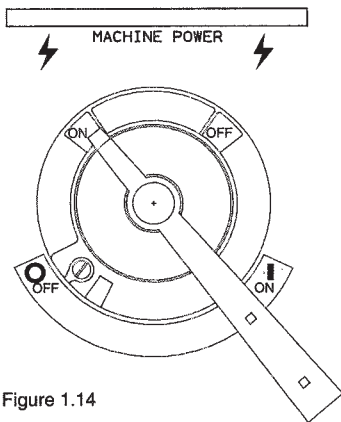

Figure 1.14

The function of the disconnect is to turn the power OFF when doing any maintenance or repairs and when your Valley is not in use.

3 SECOND AUTO RESTART

A three second auto restart is standard equipment built into the circuitry of the Valley system. In the event of a momentary power loss or voltage drop, the system will automatically restart, if power is returned within three seconds.

⚠ CAUTION

TO REDUCE THE POSSIBILITY OF DAMAGE TO AN AUTOMATICALLY CONTROLLED ELECTRIC PUMP DUE TO A MOMENTARY POWER LOSS OF 3 SECONDS OR LESS, A PUMP RESTART DELAY IS REQUIRED IN THE PUMP CIRCUIT BETWEEN THE PIVOT CONTROL PANEL AND THE PUMP.

SET UP

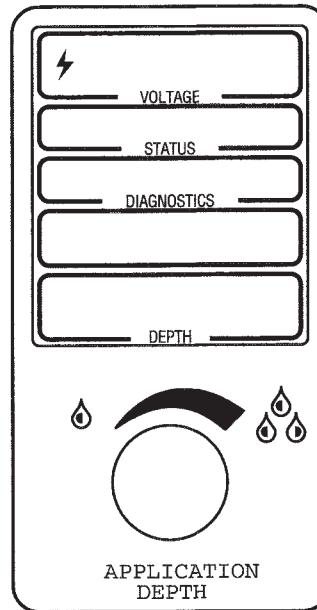

Figure 1.15

← Press SETUP for 2, 4, 6 or 8 seconds to access the 4 different Setup Groups.

○ SETUP

○ SELECT

The SET UP button accesses the panel set up mode. The operator must enter necessary information about the machine at the time of initial start up. Section II "Select Panel Set Up" on page 12, explains the use of the set up feature.

FORWARD AND REVERSE START

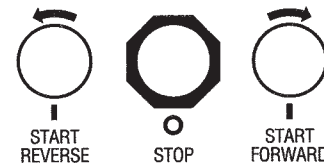

Figure 1.16

Symbol ID:

- Indicates "On" or "Start".
- Indicates "Off" or "Stop".

Enables the operator to start the machine in the forward (clockwise) or reverse (counter-clockwise) direction assuming all safety circuits are complete. To start the machine, press either button and release. *The machine has a built in time delay that will not allow*

it to be restarted by pressing the Forward or Reverse Start buttons within five seconds after being stopped. The direction of travel can be changed while the machine is moving.

STOP



Press this button to STOP the machine and shut the pump off/close the water valve. This is assuming the pump/water valves are wired such that when the Valley stops, the pump shuts off and the water valve (if present) closes automatically.

Figure 1.17

WATER ON/OFF

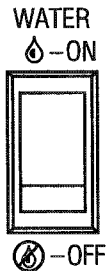



Symbol ID:
 Indicates "water is on".
 Indicates "water is off".

Figure 1.18

- 1) Press and release WATER ON to run the machine with water.
- 2) Press and release WATER OFF to run the machine without water.

NOTE: Selecting either WATER ON or WATER OFF will not start the pivot or pump, but it does instruct it what to do when it is started. If WATER ON is selected and the pivot is started, the pump will start and the equipment will not move until the pressure reaches the low pressure setting. Selecting WATER OFF disables the pump and the equipment can run without water. When the machine is in the WATER OFF mode, the low pressure shutdown feature is bypassed.

The WATER ON/OFF rocker switch may also control a water valve by itself or in conjunction with a pump. This will depend on how the water delivery system is designed. If there is a question as to what the WATER ON/OFF switch controls, contact your local Valley dealer to determine how it is wired and what it controls.

APPLICATION DEPTH

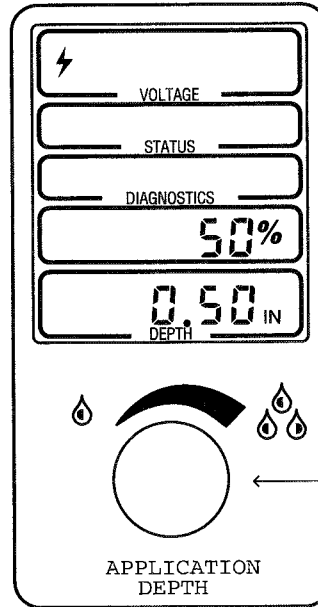

Turn clockwise to increase water application.
 Turn counter clockwise to decrease water application.

Figure 1.19

The APPLICATION DEPTH knob controls the depth of water (either in inches or millimeters) to be applied in one revolution. To increase the water application depth, turn the knob to the right. To decrease the water application depth, turn the knob to the left. Changing the water application depth, also causes the percent timer (illustrated in figure 1.19) to change. The percent timer controls the revolution time of the machine which controls the amount of water applied.

NOTE: If the machine is NOT applying water (WATER OFF is selected), the DEPTH window in figure 1.19 will show 0.00 IN or MM. The APPLICATION DEPTH knob is then used to control the percentage timer. A percent timer setting of 100 percent would give the operator the fastest revolution time.

NOTE: If the machine is running and applying water and WATER OFF is selected, the machine will continue to run with the water supply turned off and the percent timer will automatically be set to the last percentage timer setting the machine ran when WATER OFF was selected previously. (The Select panel will automatically use 100 percent if there was no other previous settings by the operator). If WATER ON is then selected, the water application depth will automatically be set to the last known setting when WATER ON was previously selected. The Select panel remembers the last known percentage timer settings and applies them when the operator switches between WATER OFF and WATER ON.

AUTO RESTART ON/OFF

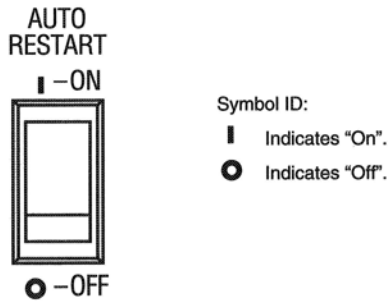

Figure 1.20

Auto Restart provides the option to restart your machine automatically after a loss of power or water pressure. It is important to note that both power and pressure restart is active if the switch is in the ON position. Turn the feature off if auto restart is not required.

POWER RESTART

Your machine will restart when power is restored and will use the same running conditions as when it lost power.

However, the following conditions apply.

If the water pressure is ABOVE the low pressure setting when the power is restored, the machine will restart immediately without going through the Power Restart Delay period.

If the water pressure is BELOW the low pressure setting when the power is restored, the machine will wait for the amount of time specified in the Power Restart Delay (refer to Section II - Power Restart Delay).

IMPORTANT: The machine will only restart if it was last shut down because of a loss of power or pressure.

If the machine is shut down by pressing the STOP button or by an end of field shut down, it would NOT power restart if there were a loss of power because the initial shut down was not caused by loss of power or pressure.

When the operator starts the machine and the Auto Restart switch is in the ON position, Auto Restart is active again.

AUTO REVERSE/STOP

The Select Panel offers the operator two different ways in which the pivot can be automatically stopped or it's direction of travel changed. These include:

OPTION I – Drive Unit Mounted Auto Reverse/Auto Stop

OPTION II – Operator Programmed Reverse and/or Stop Positions

OPTION I – Drive Unit Mounted Auto Reverse/ Auto Stop

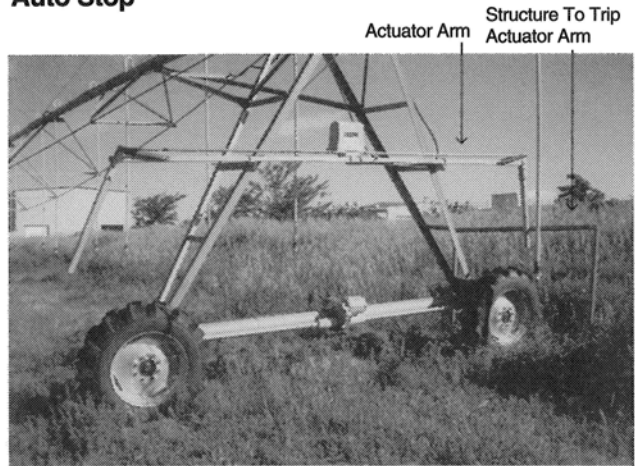

Drive Unit Mounted Auto Reverse/Auto Stop Option

Figure 1.21

IMPORTANT: If the pivot needs to reverse around or stop at a physical obstacle (such as a tree line, building, grain bin, etc.) it is required that the Drive Unit Mounted Auto Reverse/Auto Stop option must be purchased and installed including a physical barricade as illustrated in figure 1.21. See your Valley dealer for more information concerning this matter.

Drive Unit Mounted Auto Reverse/Auto Stop illustrated in figure 1.21 is an option which can be purchased to automatically stop the pivot or change it's direction of travel. Two different options can be purchased, one which only stops the machine (Drive Unit Mounted Auto Stop) and one which will both stop and change the machine's direction of travel (Drive Unit Mounted Auto Reverse/Auto Stop).

The assembly illustrated in figure 1.21 is used for both drive unit mounted auto stop and drive unit mounted auto reverse/auto stop (combined options). The auto stop option will stop the machine when the actuator arm contacts the "trip structure". If the auto

reverse/auto stop option is installed, the operator may choose to either stop the machine when it reaches the “trip structure” or have the pivot automatically change it’s direction of travel and continue to run. This can be selected with the Auto Reverse/Auto Stop Switch as illustrated in figure 1.22.

Points to Keep in Mind:

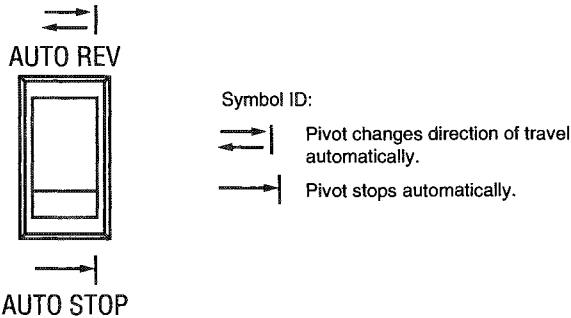

Figure 1.22

- If drive unit mounted auto stop or auto reverse/stop has been installed as an option, then the operator must also enable this feature in SET UP Group 4 — “Auto Reverse/Stop Enable”. This allows the switch in figure 1.22 to be active and causes the equipment to change direction if the “Auto Reverse” position is selected.
- If only the drive unit mounted auto stop option has been purchased without the auto reverse feature, then the position of the switch in figure 1.22 does not matter. The equipment will stop when the actuator arm is tripped regardless of the position of the switch.
- Care must be taken when the option in figure 1.21 is used. The operator MUST ensure the actuator arm contacts the trip structure. Under certain conditions, soil may build up in the wheel track resulting in a ramp effect allowing the actuator arm to go over the structure to trip the actuator arm.

OPTION II — Operator Programmed Reverse and/or Stop Positions

The Select Panel offers a programmable feature which allows the operator to select two positions at which the pivot can either be stopped or it’s direction of travel changed. A typical situation is illustrated in figure 1.23.

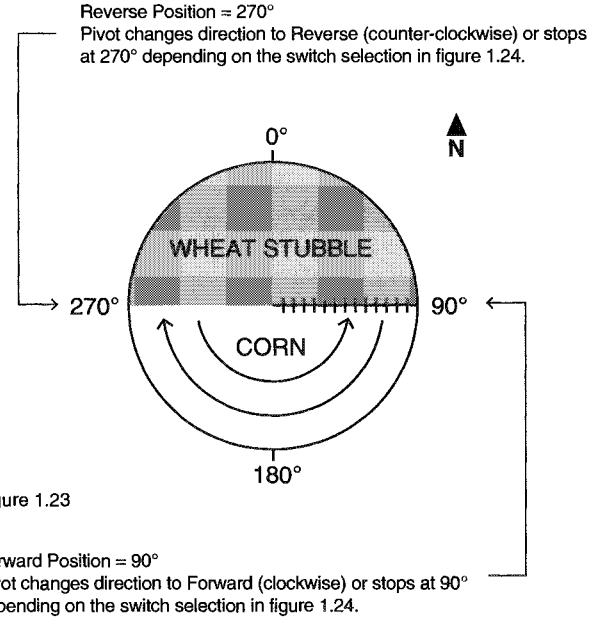

Figure 1.23

The field in figure 1.23 is an “open” field. There are not any physical obstacles such as a tree line, building, grain bin, etc. which the pivot needs to stop for or change it’s direction of travel at. The operator only wants to apply water to the South half of the field which is in corn. In this situation, the Select Panel allows the operator to input two values:

Forward Position: Position (in degrees) where the machine changes direction from Reverse to Forward (90 degrees in figure 1.23).

Reverse Position: Position (in degrees) where the machine changes direction from Forward to Reverse (270 degrees in figure 1.23).

The forward value of 90 degrees will cause the pivot to change the direction to forward at 90 degrees. The reverse value of 270 degrees will cause the pivot to change the direction to reverse at 270 degrees.

The auto reverse/auto stop switch illustrated in figure 1.24 determines if the pivot will change it’s direction of travel at the programmed positions or stop it.

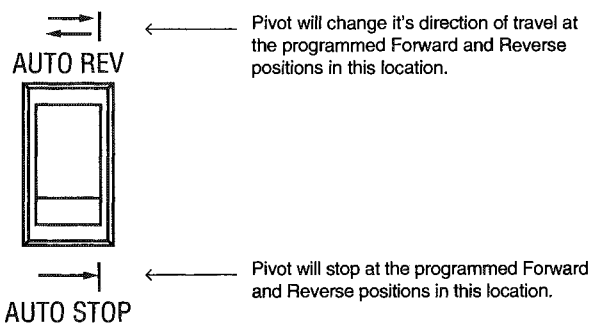

Figure 1.24

IMPORTANT: If the machine needs to reverse around or stop at a physical obstacle (such as a tree line, building, grain bin, etc.) it is required that the Drive Unit Mounted Auto Reverse/Auto Stop option must be purchased and installed including a physical barricade as illustrated in figure 1.21. The operator programmed feature described in this section must only be used when physical obstacles are not present. See your Valley dealer for more information concerning this matter.

Points to Keep In Mind:

- This feature requires three items to be input in SETUP Group 4 which include: 1) Enable the feature 2) Set the Forward Position 3) Set the Reverse Position. Refer to Section 2 “Select Panel Set Up” for the necessary procedures to set the forward and reverse values (pages 37 to 39).
- Remember, this feature **MUST NOT** be used if physical obstacles are present in the field without a physical barricade!!!

STOP IN SLOT

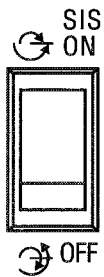

Symbol ID:

- ⤴ Stop In Slot is turned on. Pivot will stop at the preset location.
- ⤴ Stop In Slot is turned off. Pivot will not stop at the preset location.

Figure 1.25

Allows the stop in slot to be activated or by-passed. Stops the machine at a preset location in the field (set by the operator in set up Group 1) when the switch is in the ON position. Setting the switch in the OFF position by-passes the Stop In Slot, so the machine will NOT stop at a preset location.

If the stop-in-slot switch is turned from off to on or if power is restored to the control panel with the Stop In Slot switch on, the screen will display the Stop In Slot position for five seconds in a flashing mode as illustrated in figure 1.26. This alerts the operator that the Stop In Slot is active and what position it is set at.

NOTE: The operator can start the machine at the stop in slot location with the switch in the ON position. The stop in slot is automatically by-passed for several degrees when starting the machine.

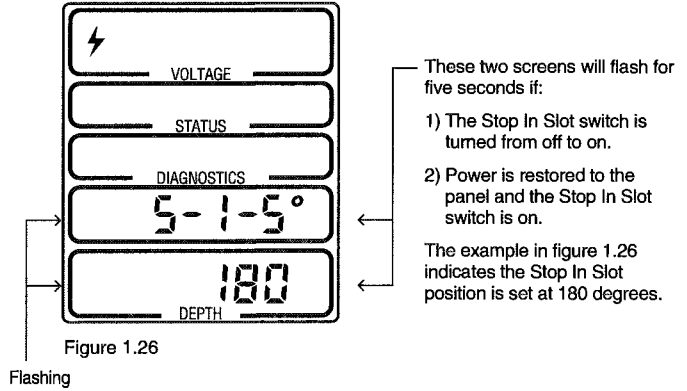

Figure 1.26

A Select Panel includes a resolver as standard equipment. The resolver allows the Select Panel to know where it is in the field and displays it on the screen in degrees. For example, 0 degrees may represent due north. The resolver then allows the stop in slot position to be set in the panel as a degree setting. Refer to Section II “Select Panel Set Up” on page 14 for information on setting the stop in slot position.

OPTION SWITCHES

The Valley Select Panel incorporates six slots for optional switches as illustrated in figure 1.27.

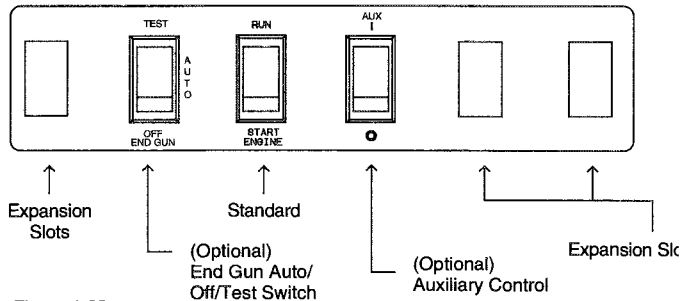
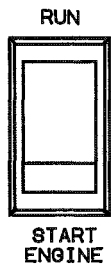

Figure 1.27

Engine Run/Start



A standard engine RUN/START switch is installed for easy wiring of the engine shutdown circuit. If the switch is in the RUN position, the engine would shut down if the pivot stops for some reason. The switch MUST be in the START position to start the engine.

Figure 1.28

Auxiliary On/Off

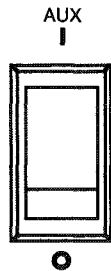

This optional switch is available for such uses as injector pump operation or other options the operator may decide to install.

Figure 1.29

Auto/Off/Test

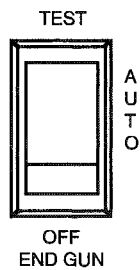

This optional switch is available to turn the end gun OFF or manually test if the end gun is operating correctly. The switch is spring loaded for the "TEST" position.

IMPORTANT: Placing the switch in the OFF position will disable end gun operation until the switch is placed in the AUTO position. Crop damage may occur if left in the OFF position.

Figure 1.30

INTRODUCTION

This section covers how to initially SET UP the Select Panel before operation. The SETUP procedure consists of entering values which are unique to each

individual field and must be entered when the panel is first installed. These values are in four separate groups as illustrated below:

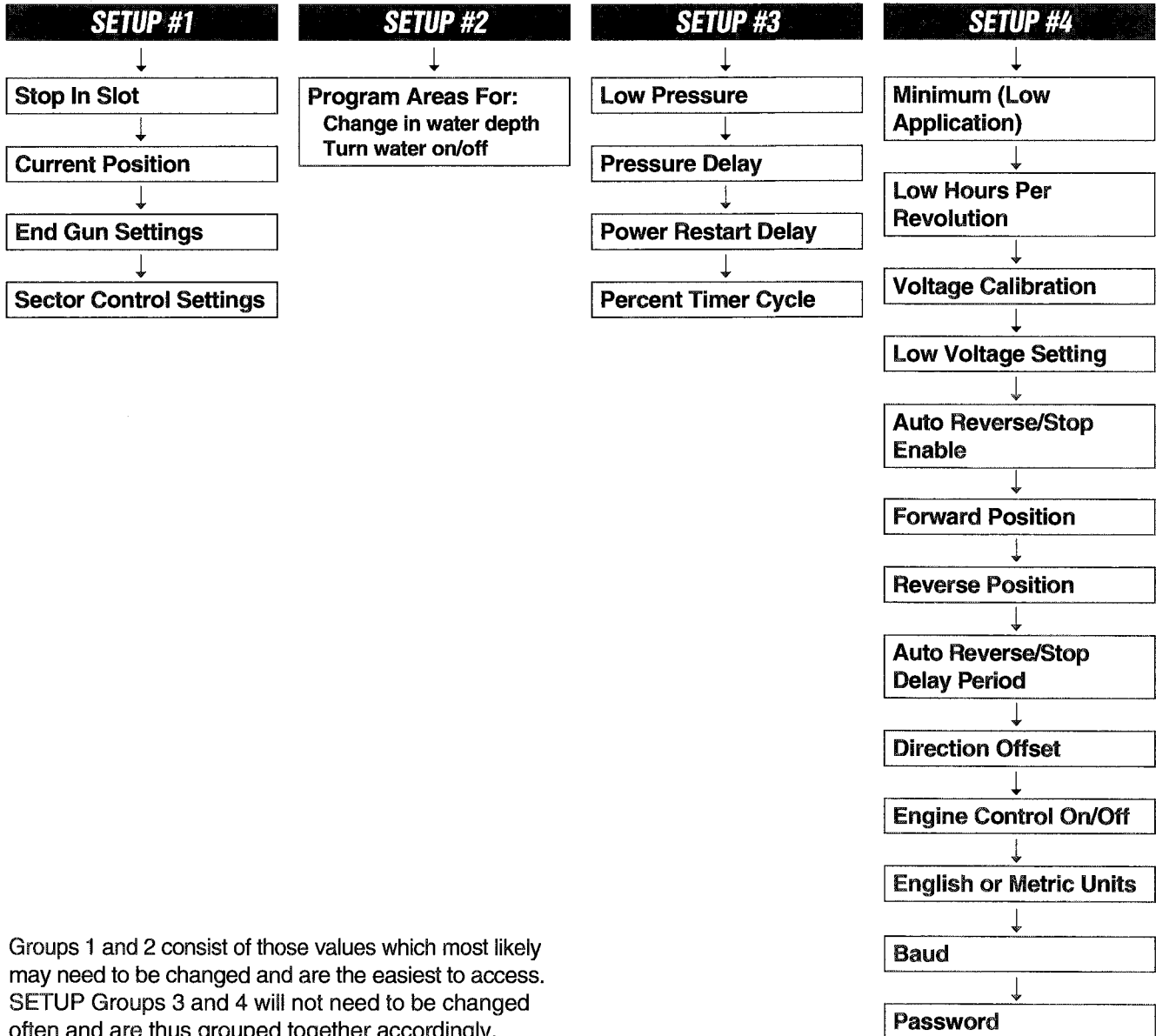

Groups 1 and 2 consist of those values which most likely may need to be changed and are the easiest to access. SETUP Groups 3 and 4 will not need to be changed often and are thus grouped together accordingly.

USING SETUP – A QUICK OVERVIEW

All of the SETUP groups are accessed by pressing the SETUP button as explained in the following steps:

1. Press the SETUP button for at least 2 seconds and the operator will be in SETUP Group 1. Release the SETUP button to make changes to values in Group 1.

2. To access SETUP Group 2, keep pressing the SETUP button in step 1 for another 2 seconds without releasing (a total of 4 seconds). Release the SETUP button at this point to make changes to values in Group 2.

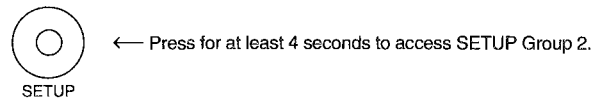
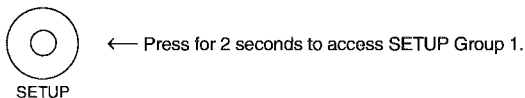

3. SETUP Group 3 is accessed by pressing the SETUP button in step 2 for another 2 seconds without releasing (a total of 6 seconds). Release the SETUP button at this point to make changes to values in Group 3.

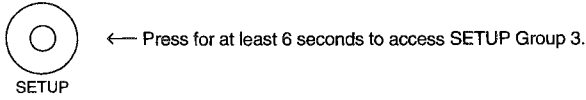

4. SETUP Group 4 is accessed by pressing the SETUP button in step 3 for another 2 seconds without releasing (a total of 8 seconds). Release the SETUP button at this point to make changes to values in Group 4.

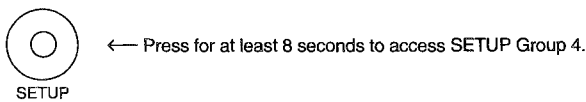

HELPFUL HINTS:

The Application Depth knob is used to set values in Groups 1, 2, 3 and 4 by turning it clockwise or counter-clockwise.

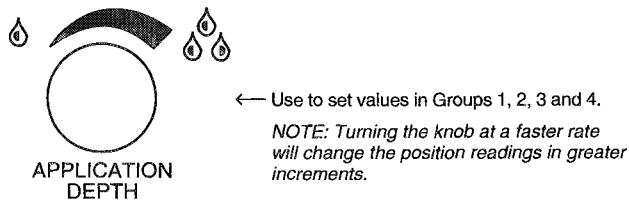

Pressing the SELECT button advances the operator to the next value in each group and saves the previous value selected by the operator.

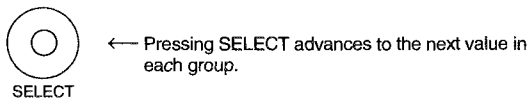

Pressing the SETUP button while setting values in any group will return the operator to the normal operating mode. Any changes made will be saved at this point.

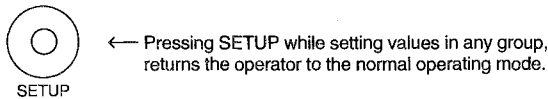

NOTE: If the SELECT or SETUP button is not pushed or the Application Depth knob is not turned within 60 seconds during the SETUP mode, the screen will return to the normal operating mode. Press SETUP again to re-enter the SETUP mode.

SETUP GROUP 1

The following values can be set within SETUP Group 1:

- Stop In Slot
- Current Position
- End Gun Settings
- Sector Control Settings

The settings for each of these values are input as degree values (0-360 degrees). The Select Panel can determine the position of the pivot in degrees because of a device which is called a “resolver”.

The resolver is a device which is mounted in the collector ring as illustrated in figure 2.1

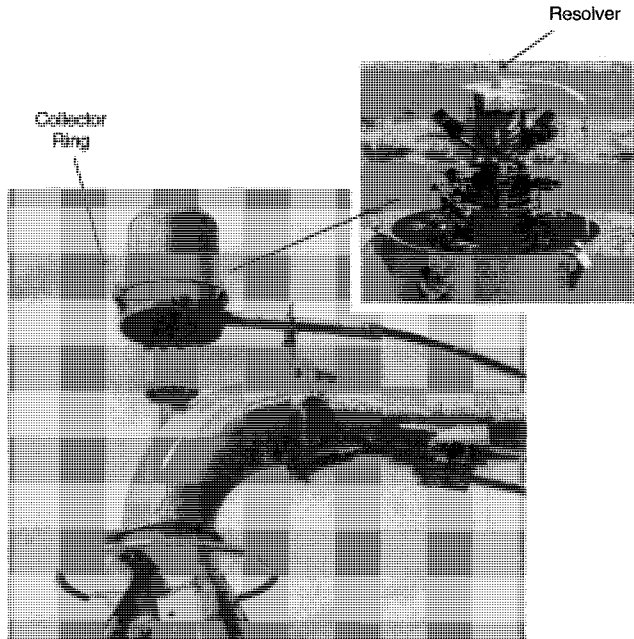

Figure 2.1

As the pivot rotates, the shaft of the resolver turns. This sends voltage signals back to the control panel. The panel converts these signals to a position reading on the display screen. The resolver allows the Stop In Slot, current position, end gun and sector control settings to be set from the control panel as degree values (0-360 degrees for a full circle center pivot).

To access SETUP Group 1, press the SETUP button for at least 2 seconds and release. The Stop In Slot setting screen will be displayed as illustrated in figure 2.2.

Stop In Slot

The stop in slot feature allows the operator to stop the pivot at a set position such as a field road. If the stop in slot feature is on, the pivot will stop at this position every time. The stop in slot location will be set at 0 degrees from the factory as illustrated in figure 2.2.

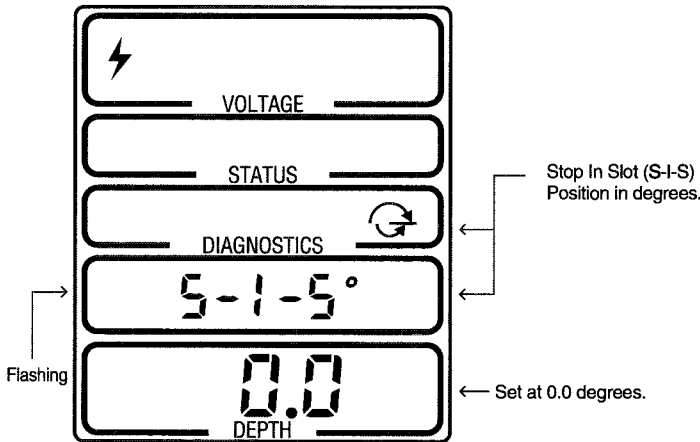
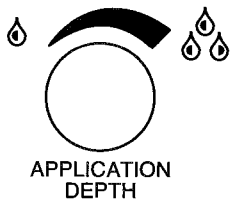

Figure 2.2



1. Turn the knob to adjust the stop in slot position to the desired value. This position can be set to the nearest tenth of a degree.



2. Press SELECT to save and change/view the next value which is Current Position.

Current Position

The current position reading of the machine is displayed in degrees. North is usually referred to as 0 degrees as indicated in figure 2.3.

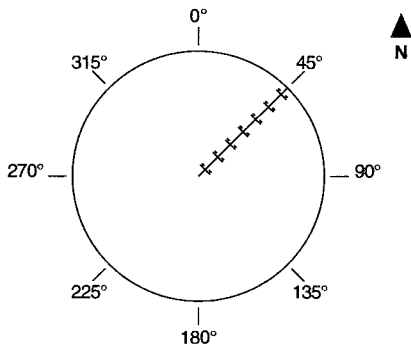

Figure 2.3

When the machine is first installed, the current position of the pivot must be specified. According to figure 2.3, the machine is pointing towards 45 degrees (Northeast). Therefore, the current position must be set at 45.0 degrees (or at whatever position the operator wants the machine to be displayed at on the screen). The end gun, sector control, stop in slot settings, and any other position related features will all reference this initial position setting, so it is important to understand the Current Position value.

NOTE: Let's assume that a road is located where the pivot is in figure 2.3 and the operator wants to define this position as 0 degrees (for easy reference). This could be achieved by entering "0.0" degrees for the current position instead of 45.0 degrees. East would then be displayed as 45 degrees, South as 135 degrees, etc.

The following screen will be displayed after previously entering the Stop In Slot setting. The screen in figure 2.4 displays the Current Position setting which may be different than the desired value.

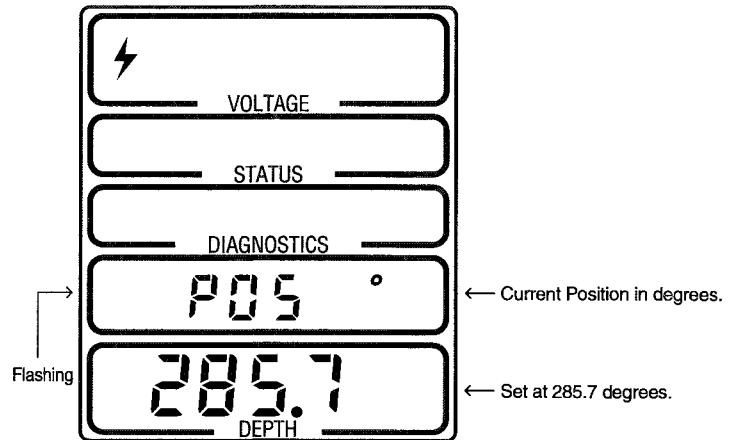
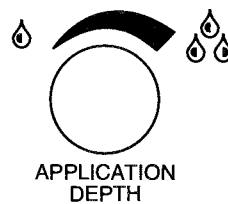

Figure 2.4



1. Turn the knob to adjust the current position to the desired value (in this example, 285.7 degrees would be changed to 45.0 degrees)



2. Press SELECT to save and change/view the next values which are End Gun settings.

End Gun Settings (Setting for the First Time)

Figure 2.5 illustrates an example end gun on/off arrangement which will be used to demonstrate how end gun settings are entered. This field is bordered on three sides by roads but the end gun will be on the entire time on the North side.

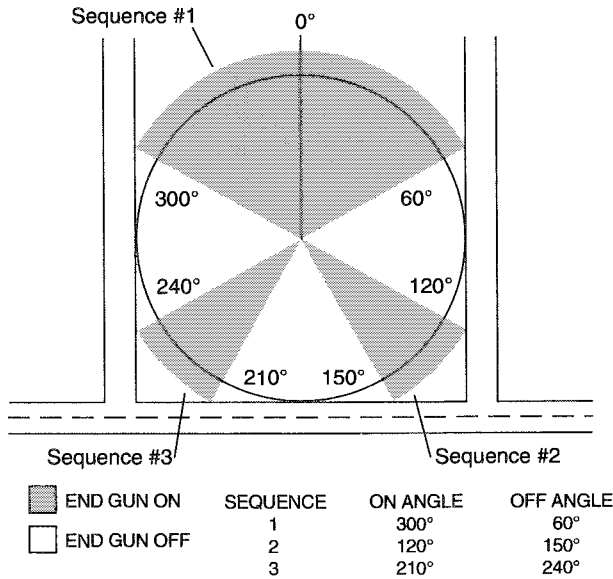

Figure 2.5

NOTE: One sequence consists of two steps. The first is to turn the end gun on and the second is to turn it off.

The first end gun setting screen is displayed in figure 2.6. This screen will be displayed immediately after the previous current position setting has been input.

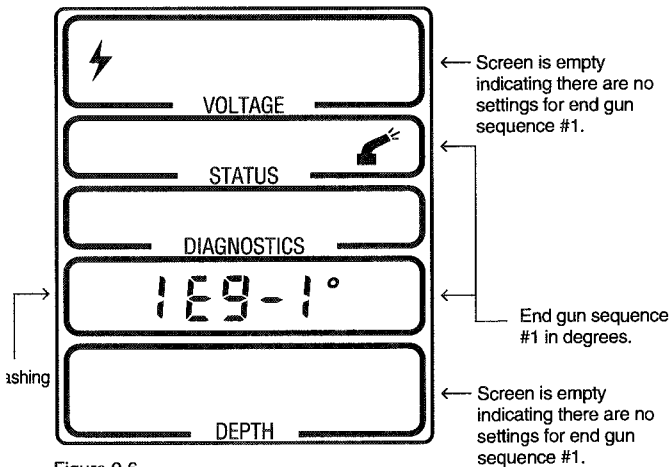

Figure 2.6

Notice that the end gun icon (symbol) is displayed indicating that the operator is in the end gun setting screen. A description of the setting is also displayed (**1Eg - 1°**) to identify it as end gun sequence #1. Following is a complete explanation of the end gun setting description.

1 Eg - 1°

The "1" in (**1 Eg - 1°**) indicates that the settings are for the end gun. The SELECT Panel can utilize two sets of controls, the first (1) for the end gun and the second (2) for another set of sector controls. The second set of controls will be fully discussed in the next section entitled "Sector Control Settings" and are identified with the number "2" as (**2 Eg - 1°**).

"Eg" is used to represent "end gun" settings. However, "Eg" is also used to represent the sector control settings since the sector control settings can be used to control a second end gun if desired.

"1" in (**1 Eg - 1°**) represents the first sequence or the first set of end gun settings. A sequence consists of an "on" and "off" angle. The area of the field between this wedge is where the end gun will be on. The first angle which is entered will be the "on" position. The end gun will be on in a clockwise direction to the "off" position. A total of six on/off sequences can be input for end gun settings.

"°" is the symbol to indicate that the values which are input are all in degrees.

1 Eg - 1°

NOTE: The example in figure 2.5 requires three on/off sequences to be input. The order in which they are entered does not affect how the end gun turns on/off. For example, sequence #1 could be entered as "on" angle = 210.0 degrees and "off" angle = 240.0 degrees instead of 300.0 and 60.0 degrees respectively.

The end gun on/off sequences will operate the same whether or not the machine is running in the forward or reverse direction. For example, sequence #1 consists of an "on" angle of 300.0 degrees and an "off" angle of 60.0 degrees. If the pivot is traveling in the forward (clockwise) direction approaching 300.0 degrees, the end gun will turn on at 300.0 degrees and shut off at 60.0 degrees. Now let's assume the pivot is moving in the reverse direction approaching 60.0 degrees. The end gun will turn on at 60.0 degrees and shut off at 300.0 degrees.

The values in figure 2.5 will be used to demonstrate how end gun on/off angles are input in the following procedure:

1. Turn the knob to select the value of the first "on" angle (300.0 degrees in this example). Notice that the area of the screen in figure 2.7 which shows the value of the angle setting will be blank until the operator turns the knob. It will then display values starting from zero degrees and is adjusted from 0.0 degrees by turning the knob to either increase or decrease the angle value. "on" is also displayed in the top screen to remind the operator that an "on" angle is being set. "on" will change to "OFF" as soon as the SELECT button is pressed to set the "on" angle. Notice that the on and off angles can be set to the nearest tenth of a degree.

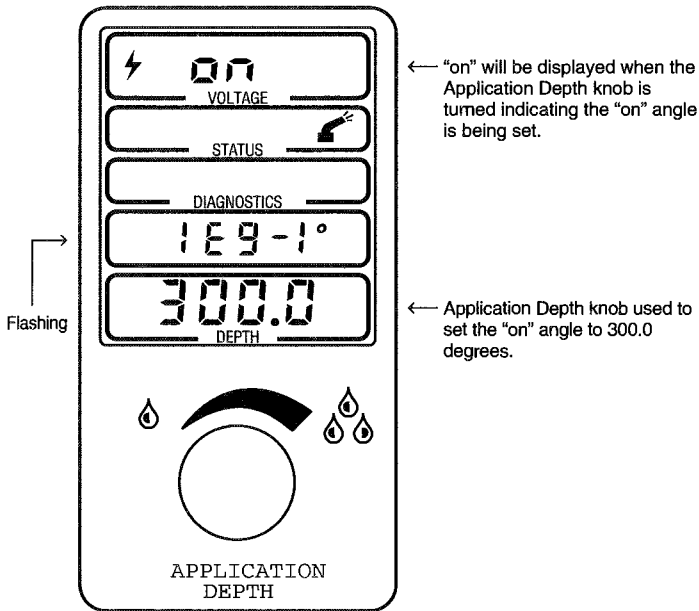

Figure 2.7



2. Press the SELECT button when the desired "on" angle has been selected with the knob in step #1. Pressing SELECT saves the value and allows the operator to then set the "OFF" position.

Pressing the SELECT button in step 2 will display the screen in figure 2.8. The operator must now input the "OFF" angle.

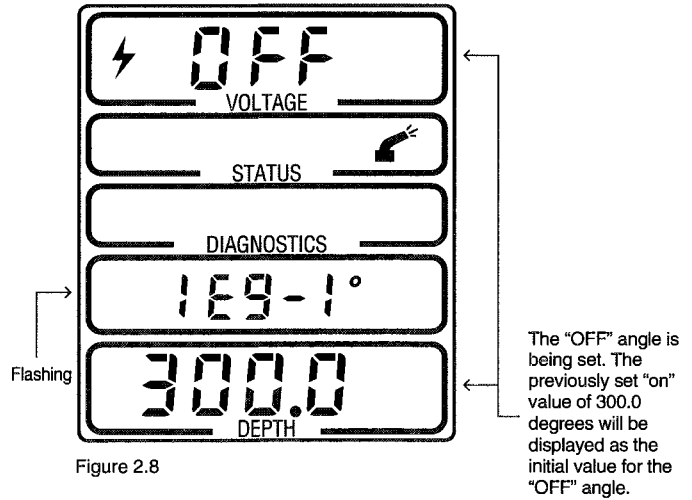

Figure 2.8

3. Turn the knob clockwise to set the "OFF" angle to 60.0 degrees. Notice that "OFF" is displayed in figure 2.9 the entire time the knob is being turned. This indicates that the end gun "OFF" value is being set.

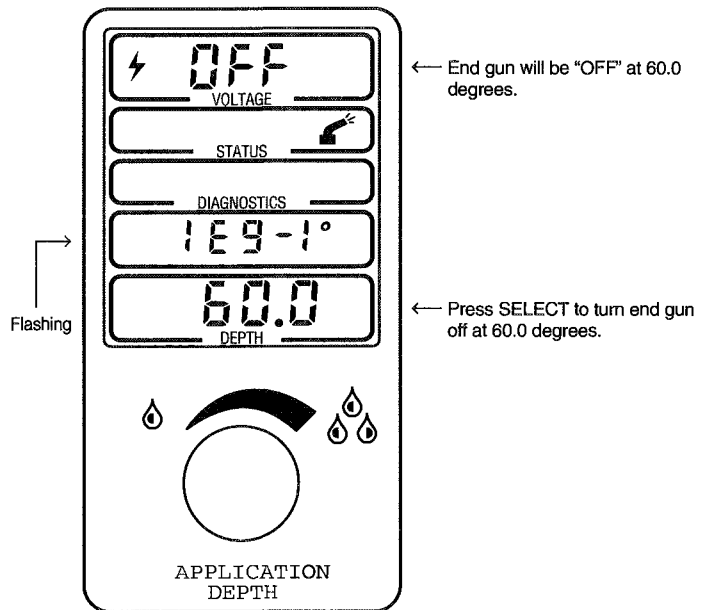

Figure 2.9



4. Press the SELECT button to set the "OFF" angle selected in step #3.

Pressing the SELECT button in step #4 displays the screen in figure 2.10. Notice that the end gun sequence description is now "1Eg - 2°". The "2" in "1Eg - 2°" indicates that the operator is now ready to enter the second set of end gun settings of 120.0 degrees "on" and 150.0 degrees "OFF".

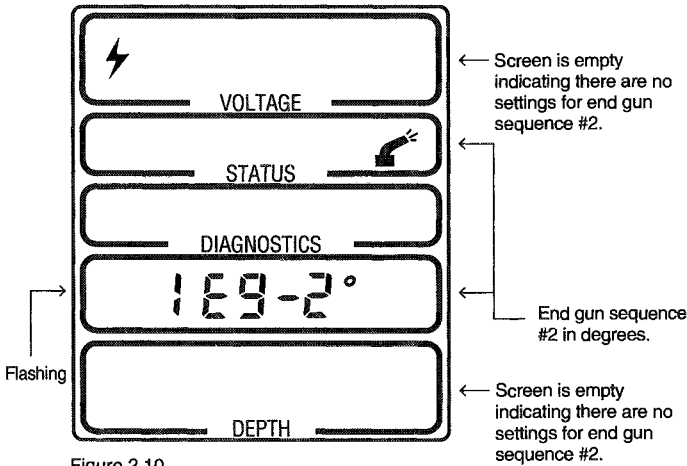

Figure 2.10

When the operator turns the knob to set the next "on" setting of 120.0 degrees, the degree setting will start incrementing from 60.0 degrees (or the last off setting entered in the previous sequence). "on" will also be displayed in the top screen.

5. Repeat steps #1- #4 to input the remaining on/off end gun angles for sequences 2 and 3.

Remember that 6 different end gun on/off sequences can be input. These are identified as :

- 1Eg - 1°
- 1Eg - 2°
- 1Eg - 3°
- 1Eg - 4°
- 1Eg - 5°
- 1Eg - 6°

In this example, the operator would only require three sequences. The SELECT button would be pressed when each of the other sequences (4,5 and 6) appear to by-pass them.

For example, figure 2.11 illustrates the screen which would appear after the third sequence (on angle = 210.0 degrees, off angle = 240.0 degrees) was input in the example.

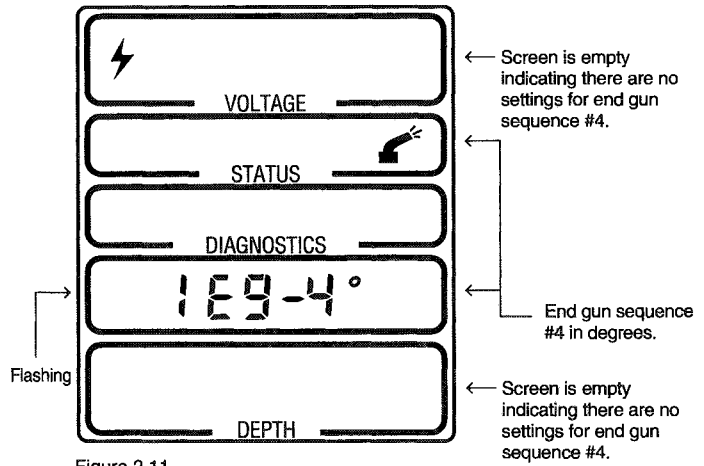

Figure 2.11

Notice that the end gun icon (symbol) and "1Eg - 4°" is all that is displayed on the screen. This indicates there are no settings for sequence #4. If the operator doesn't want to input end gun settings for sequence #4, then the SELECT button should be pressed. This will bring up the screen to input settings for sequence #5. The operator would again press the SELECT button to by-pass this sequence and not enter any settings. The following screen in figure 2.12 would then indicate that end gun sequence #6 could be entered. Notice that "1Eg - 6°" identifies the sequence as #6. The blank top and bottom screens indicates there are currently no settings entered for sequence #6. Remember, the bottom screen is where the value of the on/off angle is displayed if it is set. If it is blank, this indicates there are no values entered.

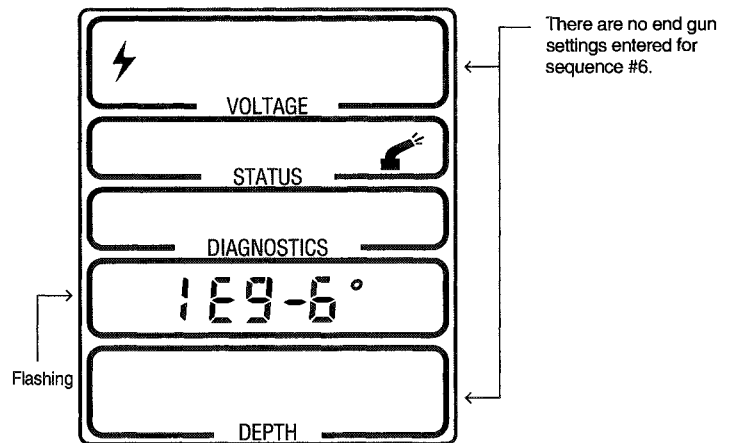

Figure 2.12

Press the SELECT button again to by-pass entering on/off angles for sequence #6. The screen in figure 2.13 will be displayed. The "2" in "2Eg - 1°" indicates the operator is now in the second set of controls referred to as the "Sector Control Settings" which are covered next.

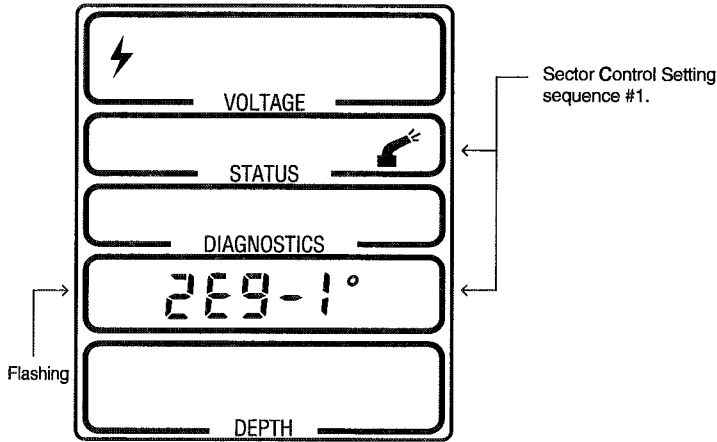

Figure 2.13

Turning The End Gun On At All Times

To turn the end gun on continuously, the operator MUST set the "on" angle to 0.0 degrees and the "OFF" angle to 360.0 degrees. This requires only one sequence.

Sector Control Settings (Setting for the First Time)

Example Applications for Sector Control Settings

The sector control settings can be used for a wide variety of applications. This feature operates in the exact same way as the end gun settings. Six sequences can be input with each sequence consisting of an "on" and "off" angle. The area of the field between the on and off angle in a clockwise direction is where a relay in the SELECT panel will be turned on. This relay would then control some type of electrical device on the machine independent of the end gun control settings.

Some examples of typical applications include the following:

EXAMPLE 1 Irrigating a Wide Boundary with a Corner Machine

Figure 2.14 illustrates a rectangular shaped field which is irrigated by a corner machine. This situation requires that the standard sequence of sprinklers which are commanded to be off in a partial extension of the corner arm, in fact are overridden, so that the sprinklers will be on.

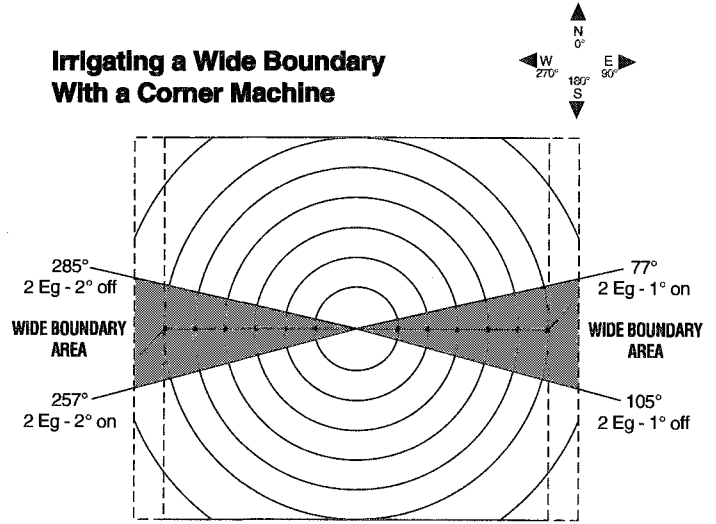

Figure 2.14

In this example, 2 sectors would be entered. Sector #1 would activate the desired sprinklers on the corner arm at 77 degrees and turn them off at 105 degrees, allowing the normal sprinkler sequencing to take over. The second sector would activate the special sprinkler sequencing between 257 and 285 degrees. Setting up the wide boundary package using the sector control settings prevents under watering of the "wide boundary area". The Valley Standard Panel would require a special package to do this, where as the SELECT Panel provides this option as part of it's standard controls.

EXAMPLE 2 Controlling Two End Guns

Figure 2.15 illustrates a field which utilizes two end guns for additional irrigated acres with little added cost. The field in figure 2.15 is bordered by roads on the West and North sides.

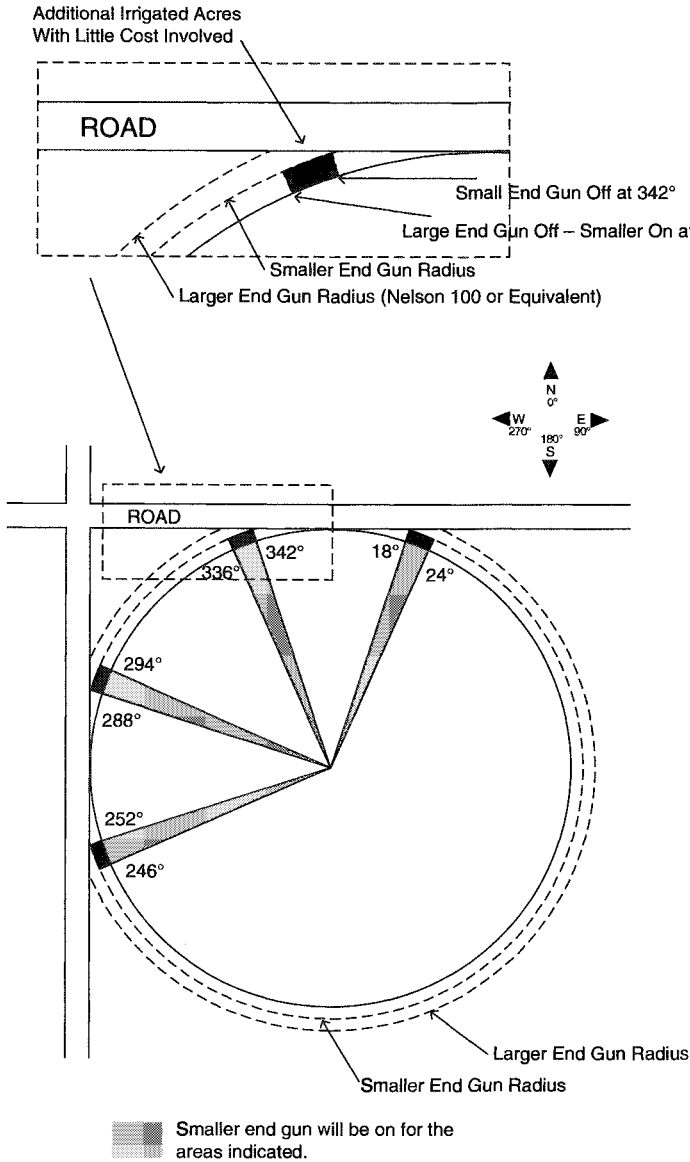

Figure 2.15

A larger end gun is used to irrigate the corners up to the roads. This end gun is controlled by the normal end gun settings discussed previously. When the larger end gun is shut off at the road, the smaller end gun is turned on for approximately 6 degrees to pick up a few additional irrigated acres. The smaller end gun is controlled with the sector control settings.

EXAMPLE 3 Controlling Sprinklers with the Sector Control Settings

Figure 2.16 displays a field which is bordered on the East side by a fence separating the neighbors field.

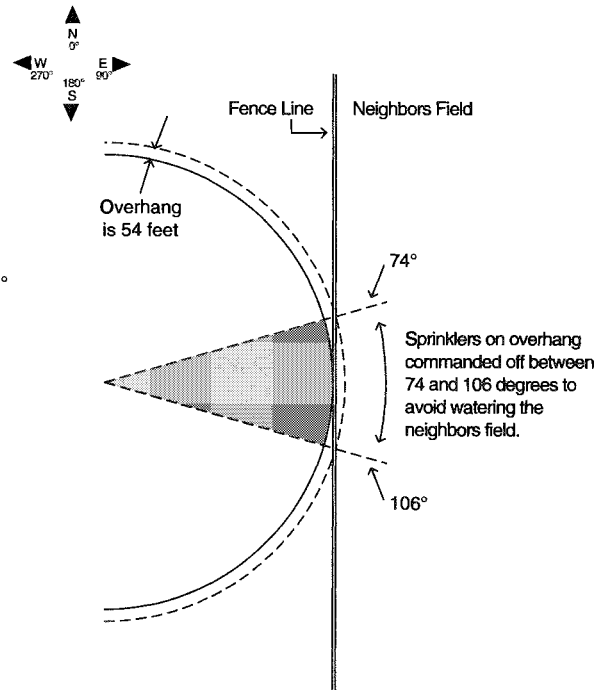

Figure 2.16

The overhang of the machine is 54 feet in length and extends over the fence into the neighbors field. The neighbor agreed that this wouldn't be a problem as long as water was not applied on the field. The operator utilizes the sector control settings to turn all the sprinklers on the overhang off at 74 degrees and back on again at 106 degrees to avoid watering the neighbors field.

IMPORTANT: All three of the examples will require some additional equipment such as extra span cable wire or relays, solenoid valves, sprinkler shut off valves, etc. Contact your local Valley dealer for information on what is required for your application and the additional cost involved.

How To Input Sector Control Settings

The procedure for entering sector control settings is exactly the same as for the end gun settings. Example #1 on page 18 will be used to demonstrate how the sector control settings are input. This requires two sequences or sets of on/off settings. They are as follows:

- Sequence #1 77 degrees on 105 degrees off
- Sequence #2 257 degrees on 285 degrees off

Remember, the sector control settings are entered immediately after sequence #6 of the end gun settings. Immediately after the on/off angles are entered or SELECT is pressed to by-pass entering angles for sequence #6 of the end gun angles, the screen in figure 2.17 will be illustrated. This is the same screen which was discussed in figure 2.13. Notice that "2Eg - 1°" is displayed to describe the setting. The "2" in "2Eg - 1°" indicates the operator is inputting sector control settings. The "1" indicates sequence #1.

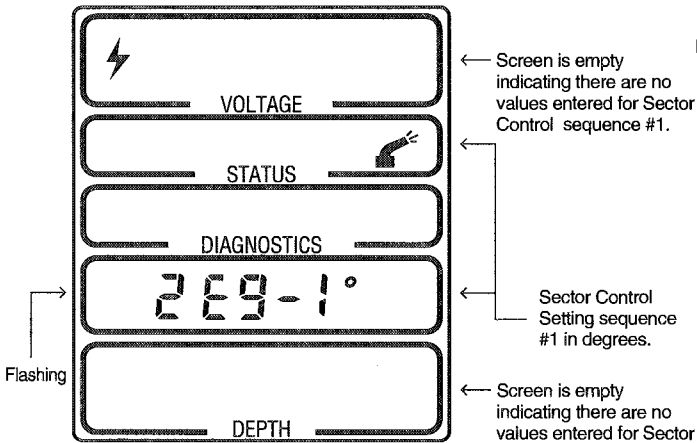

Figure 2.17

The blank top and bottom screens indicate that there are no values currently entered for sector control setting sequence #1. As soon as the Application Rate knob is turned, "on" will be displayed in the top screen indicating that the "on" angle is being set and the bottom screen will start incrementing from 0.0 degrees.

Notice that the end gun icon is also displayed. Since the sector control settings can be used for controlling two end guns as discussed previously, the end gun icon is used to describe the sector control settings.

The following steps should be used to set sector control settings. The settings in Example #1 on page 18 will be used for demonstration purposes.

1. Turn the knob to select the value of the first "on" angle (77 degrees in this example). Notice that the area of the screen in figure 2.18 which shows the value of the angle setting will be blank until the operator turns the knob. It will then display values starting from zero degrees and is adjusted from 0 degrees by turning the knob to either increase or decrease the angle value. "on" is also displayed in the top screen to remind the operator that an "on" angle is being set. "on" will change to "OFF" as soon as the SELECT button is pressed.

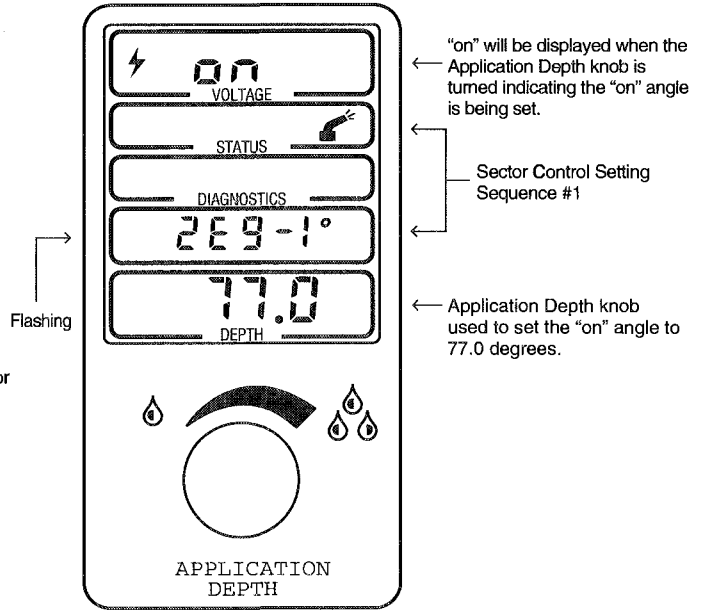

Figure 2.18



2. Press the SELECT button when the desired value of the "on" angle has been selected with the knob in step #1. Pressing SELECT saves the "on" value and allows the operator to then set the "OFF" position.

Pressing the SELECT button in step 2 will display the screen in figure 2.19. The operator must now input the "OFF" angle.

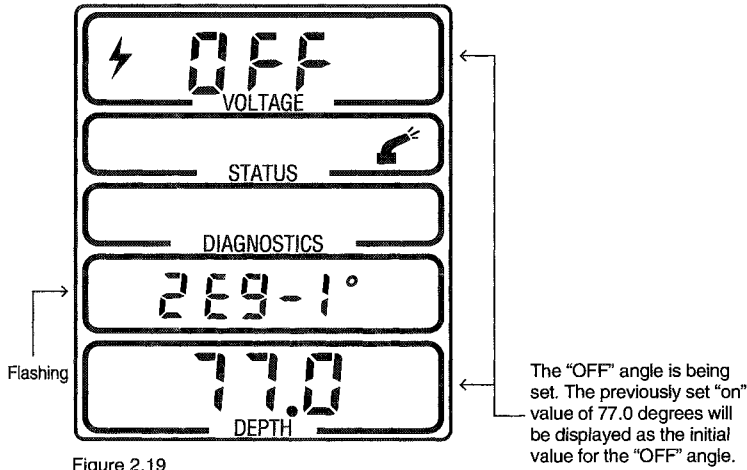

Figure 2.19

3. Turn the knob clockwise to set the "OFF" angle to 105 degrees. Notice that "OFF" is displayed in figure 2.20 the entire time the knob is being turned. This indicates that the sector control "OFF" value is being set.

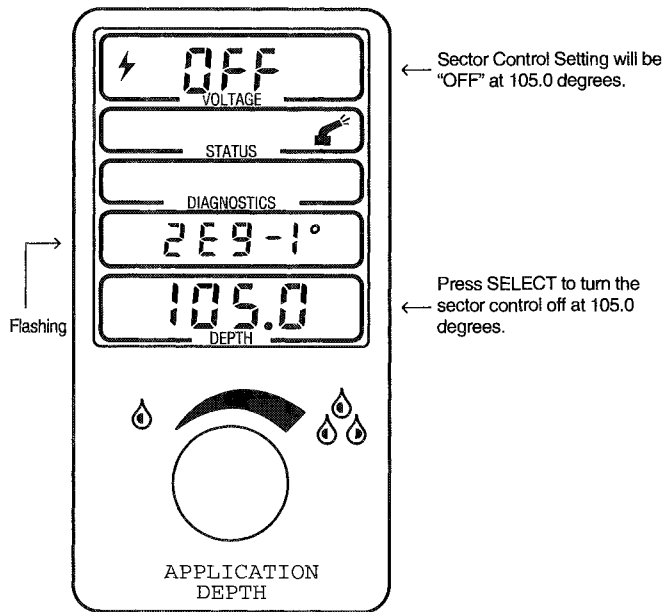

Figure 2.20



4. Press the SELECT button to set the "OFF" angle selected in step #3.

Pressing the SELECT button in step #4 will then display the screen in figure 2.21. Notice that the sector control sequence description is now "2Eg - 2". The second "2" in "2Eg - 2" indicates that the operator is now ready to enter the second set of sector control settings of 257 degrees "on" and 285 degrees "OFF".

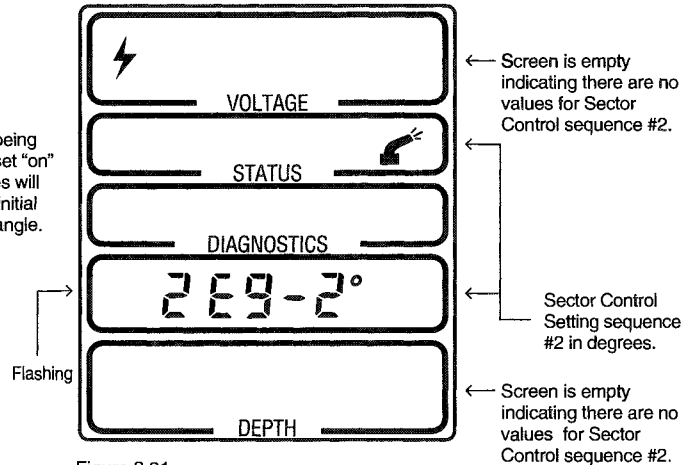

Figure 2.21

When the operator turns the knob to set the next "on" setting of 257 degrees, the degree value will start incrementing from 105 degrees (or the last off setting entered in the previous sequence). "on" will also be displayed.

5. Repeat steps #1- #4 to input the remaining on/off sector control angles for sequence #2.

The screen in figure 2.22 will be displayed after sequence #2 has been entered.

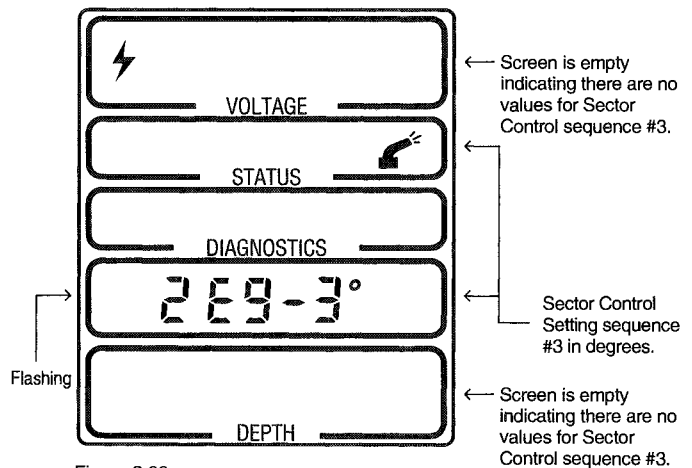

Figure 2.22

"2Eg - 3⁰" is displayed indicating that an "on" angle for sequence #3 can be entered. To by-pass entering values for sequences 3, 4, 5, and 6, press the SELECT button each time. This will exit the operator from the Setup mode and will save all previous settings. The operator can also exit the screen at this point by pressing the SETUP button. This will also exit the operator from the setup mode and save all previous settings.

SETUP GROUP 2

Entering Programmed Commands:

- Changing Water Application Depths
- Turning the Water On/Off

A unique feature of the Valley Select Panel is that it has the capability to change water application depths over different areas of the field. This feature is extremely useful when managing multiple crops on the same field. The Select Panel also allows the water to be turned off and on over specified areas of the field which could be useful for managing unplanted areas or extremely wet/swampy areas.

However, turning the water on/off only works on those installations which utilize electric pumping units equipped with a pump restart delay and wired for automatic control. Following are two different examples of how this programmable feature can be used.

EXAMPLE 1: Changing Water Applications for Two Different Crops

Figure 2.23 illustrates a typical example of how the Select Panel can be used to change water application depths for two different crops (corn and soybeans).

Example 1

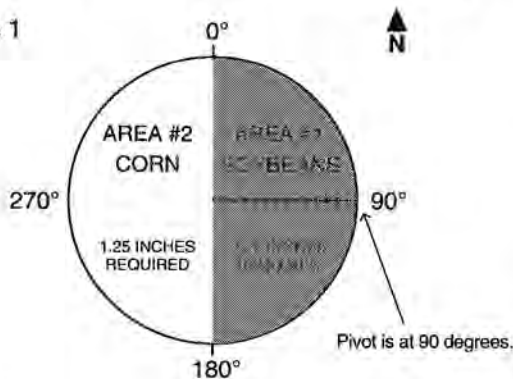

Figure 2.23

<p>Area #1 (Soybeans): On (Start) Angle = 0° Off (Stop) Angle = 180° 0.75 inches water depth</p>	<p>Area #2 (Corn): On (Start) Angle = 180° Off (Stop) Angle = 0° 1.25 inches water depth</p>
--	--

In this example, the soybeans in Area # 1 require 0.75 inches of water and the corn in Area #2 requires 1.25 inches of water.

The operator can program this example in two different ways:

1. Program both areas as follows:

Area #1

- Start at 0 degrees
- Stop at 180 degrees
- Set water application at 0.75 inches in between this area

REMEMBER — All areas must be defined in a clock-wise direction, just like the end gun settings.

Area #2

- Start at 180 degrees
- Stop at 0 degrees
- Set water application at 1.25 inches in between this area.

REMEMBER — All areas must be defined in a clock-wise direction, just like the end gun settings.

A Point To Keep In Mind:

If both areas are programmed as previously described, then whenever the pivot is started, the water application depth will automatically be set according to which area the pivot is located. If the operator turns the Application Depth knob and makes any manual changes to the water amount being applied, the program feature is turned off automatically and the operator must turn the program on again if desired. This allows the operator to manually override the program at any time by simply making a manual change in the amount of water being applied.

2. Program Only One Area

In this example, the operator could decide to program only one area. The area which was not programmed would be set manually by the operator.

As an example, assume the operator decides to only program Area #2 in Example #1 which is the corn. The operator would start the pivot at 90 degrees and would manually instruct the application depth to be 0.75 inches. The pivot would travel either forward or reverse to the corn and as soon as it entered Area #2, the water application depth would change to 1.25 inches. When the pivot traveled out of the corn the water application depth would be changed back to the original setting by the operator in the soybean area which was 0.75 inches.

In this example, both areas will be programmed, however both examples of programming previously described will work. The operator must understand how each one works and the slight differences between them.

To program Example – 1, access SETUP Group 2 by pressing the SETUP button for at least 4 seconds and then releasing it. After 2 seconds the operator will see the Stop In Slot setting screen. Two seconds thereafter, the screen in figure 2.24 will be displayed.

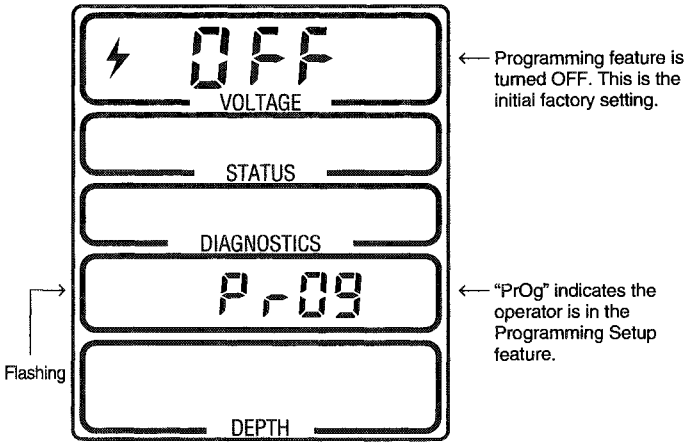
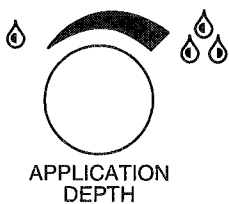

Figure 2.24

The programming feature must be initially turned on to be active. Notice that in figure 2.24, "OFF" is displayed in the top screen, which will be the initial factory setting. "PrOg" which represents "Program" is flashing indicating that the operator can now turn the Program feature on or off. The capability to turn the Program feature on and off, gives the operator flexibility. The operator can input areas of the field where changes should occur and then turn the feature off without losing the programmed values. Reactivation of the feature is then accomplished by turning the feature back on.

To enable (or turn ON) the programming feature, follow steps 1 and 2.



1. Turn the Application Depth knob either to the right or left. Each "click" of the knob will change the setting in the top screen from "OFF" to "ON" or vice versa.



2. Press the SELECT button to save the on/off setting selected in step #1. The screen in figure 2.25 will be displayed.

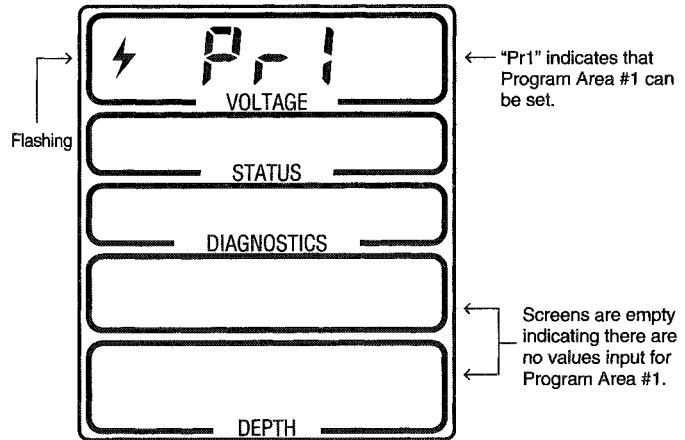

Figure 2.25

Notice that in figure 2.25, "Pr1" is displayed in the top screen. This indicates that the operator is now ready to set up area # 1 of the field as illustrated in figure 2.23. The Select Panel allows a total of 6 areas which can be programmed and are identified as ; Pr1, Pr2, Pr3, Pr4, Pr5 and Pr6. Each area will consist of 3 steps:

1. Define the start (or ON) angle of the area.
2. Set the appropriate water depth value and set Water ON or OFF.
3. Define the end (or OFF) angle of the area.

The chart in figure 2.26 will help to explain the values which need to be set for Example 1.

Area #	Start or ON Angle (degrees)	Depth of Water (IN)	Water ON	Water OFF	Stop or OFF Angle (degrees)
1 (soybeans)	0	0.75	X		180
2 (corn)	180	1.25	X		0

Figure 2.26

To program area #1, follow steps #1 through #7.

1. Turn the Application Depth knob to select the value of the start or "ON" angle for area #1 (0.0 degrees in this example). Notice that the area of the screen in figure 2.27 which shows the value of the angle setting will be blank until the operator turns the knob. It will then display values starting from zero degrees and is adjusted from 0.0 degrees by turning the knob to either increase or decrease the

angle value. "on" is also displayed in the second screen from the bottom to remind the operator that an "on" or "start" angle for area #1 is being set. In this example, the "on" angle will be set to 0.0 degrees as illustrated in figure 2.27.

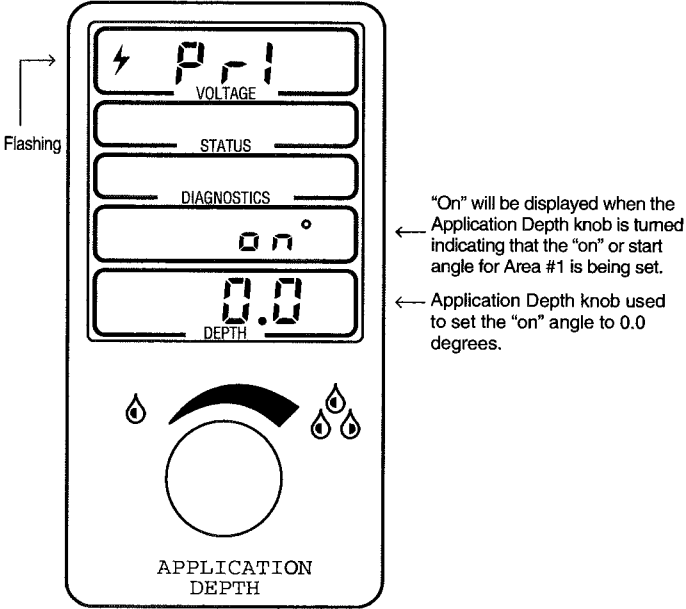

Figure 2.27



2. Press the SELECT button when the desired "on" or start angle for area #1 has been selected with the knob in step #1. Pressing SELECT saves the value and allows the operator to then set the application depth for area #1.

Pressing the SELECT button in step #2 will display the screen in figure 2.28. The operator must now do two things:

- Instruct the panel to apply water (Turn Water On/Off)
- Instruct the panel how much water to apply (Set the Water Application Depth).

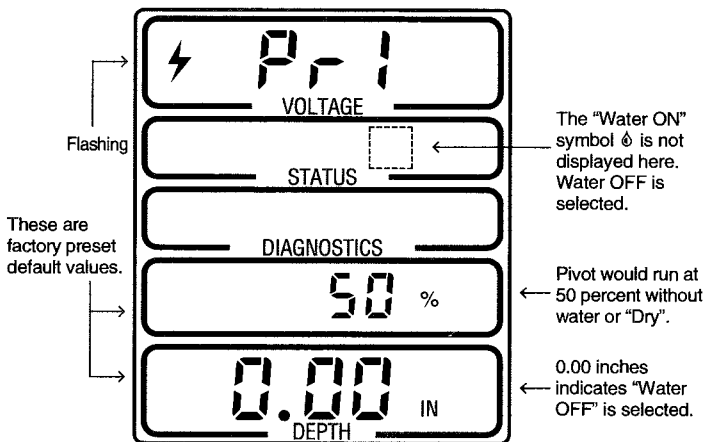

Figure 2.28

Notice that figure 2.28 initially displays 0.00 inches of water at a percent timer setting of 50 percent. Initially, the factory setting will be "Water Off". To set a water application depth for area #1, the operator must first press the "Water On" rocker switch to turn the water on.

3. Set "Water On" for area #1 by pressing "Water On".

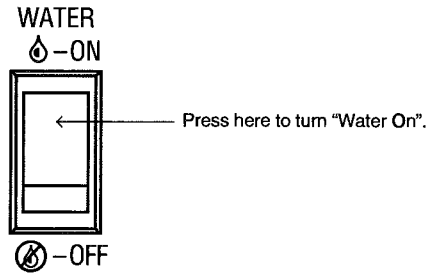

Figure 2.29

The screen in figure 2.30 will then be displayed.

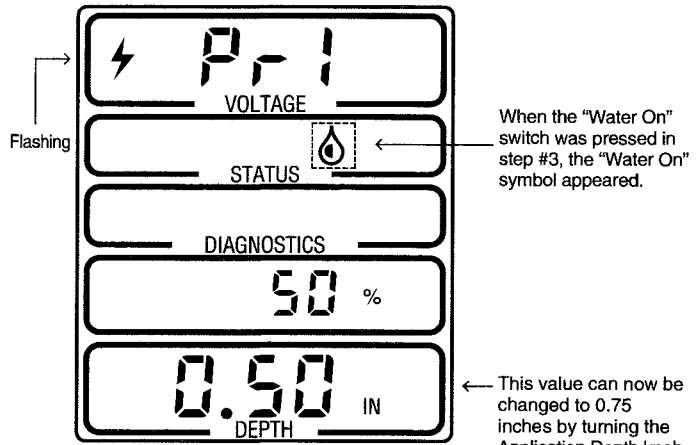

Figure 2.30

Notice that when "Water On" was pressed in step #3, the "Water On" symbol in the status screen appeared and the water application depth appeared in the bottom screen (0.50 inches in this example). The panel is now ready for the operator to select the application depth for area #1 as described in step #4.

4. To set the water application depth to 0.75 inches for area #1, turn the "Application Depth" knob clockwise to increase the value to 0.75 inches as illustrated in figure 2.31.

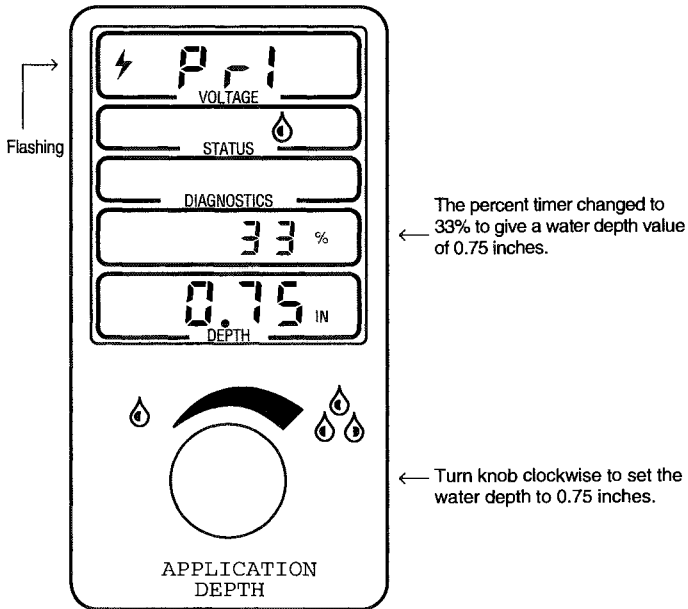

Figure 2.31

6. Turn the knob clockwise to set the "OFF" angle to 180 degrees. Notice that "OFF" is displayed in figure 2.33 the entire time the knob is being turned. This indicates that the "OFF" or Stop angle value for Area #1 is being set.

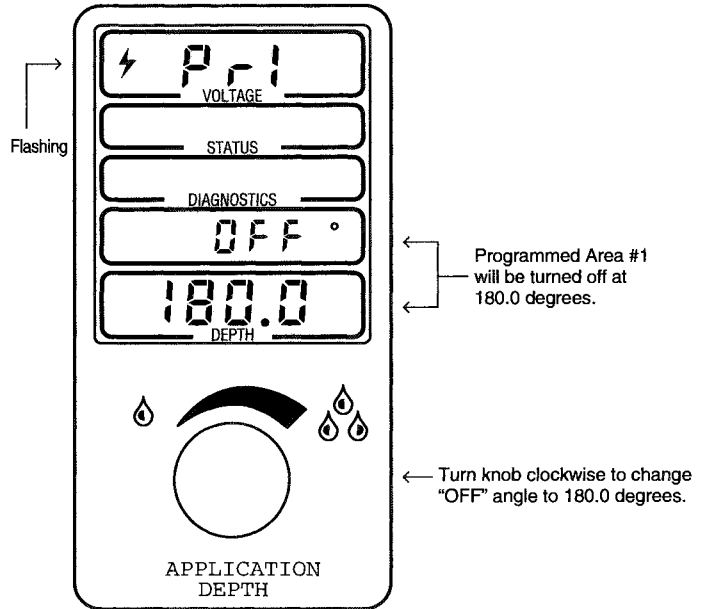

Figure 2.33

5. Press the SELECT button to set the "OFF" or Stop angle for area #1.



Pressing the SELECT button in step #5 displays the screen in figure 2.32. The operator must now input the "OFF" or Stop angle for area #1.

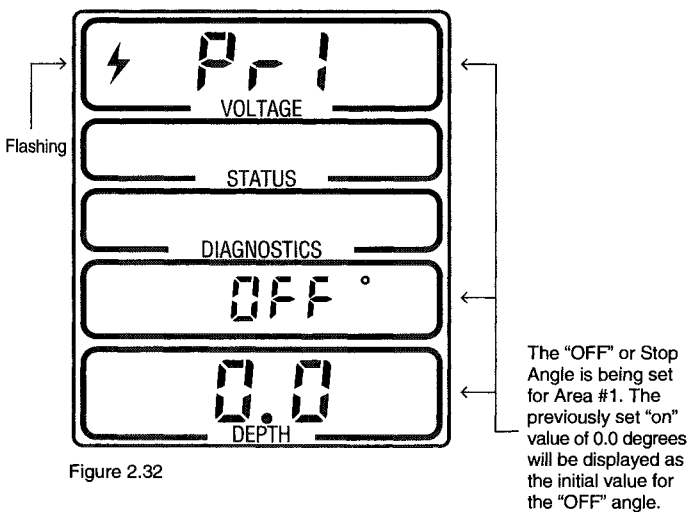

Figure 2.32

7. Press the SELECT button to set the "OFF" or Stop angle for area #1 in step #6.



Pressing the SELECT button in step #7 displays the screen in figure 2.34. Notice that "Pr2" is now displayed in the top screen. The operator is now ready to input the settings for area #2.

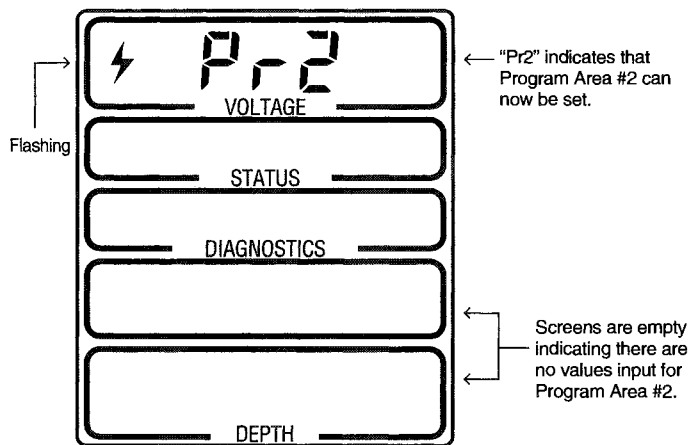

Figure 2.34

When the operator turns the knob to set the next “on” or start angle of 180 degrees for area #2, the degree setting will start incrementing from 180.0 degrees (or the last “OFF” setting entered in the previous program).

8. Repeat steps #1 - #7 to enter the remaining values for area #2 (corn).

Remember that 6 different areas can be programmed. These are identified as:

- Pr1
- Pr2
- Pr3
- Pr4
- Pr5
- Pr6

In this example, the operator would only require 2 areas (Pr1 and Pr2). When the screen in figure 2.35 appears, the operator can do one of 2 things:

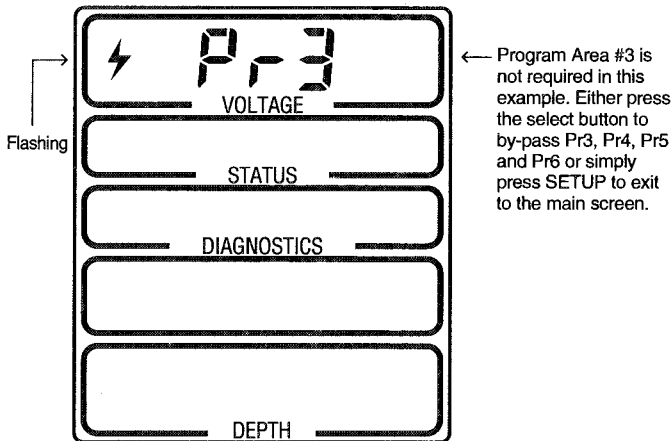

Figure 2.35

- Keep pressing the SELECT button to by-pass areas #3 - #6. This will exit the operator out of the SETUP mode and back to the main screen. This will also save the values just entered.

or

- Press the SETUP button. This will exit the operator immediately to the main screen and will save the values just entered.

How This Program Operates In The Field

The water application depth will change immediately after this program for areas #1 and #2 has been entered. It will change to values specified by the operator in the program.

For example:

In Example 1, the pivot was located at 90 degrees. The depth would change to 0.75 inches after the program is entered since the pivot is located in area #1. When the pivot traveled into area #2, the water application depth would change to 1.25 inches.

Overriding the Program

The operator can override the program (which includes ALL 6 areas) by manually turning the “Application Depth” knob. The screen in figure 2.36 will be displayed if this occurs.

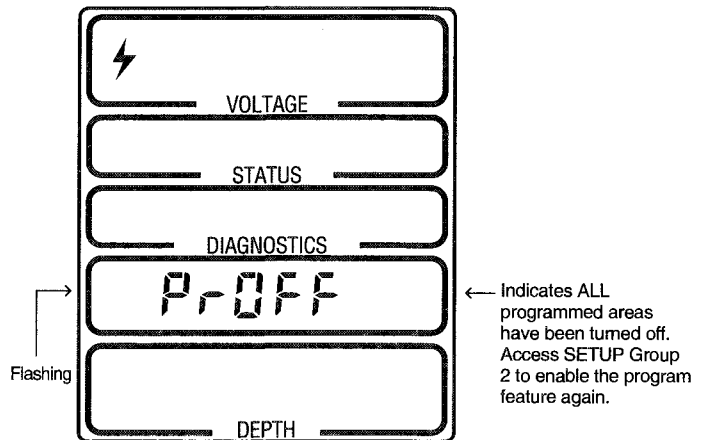

Figure 2.36

Notice that “PrOFF” will flash in the second screen from the bottom. This indicates that **ALL** programmed areas have been turned off because the operator has manually overridden the values in one of the programmed areas. Each area programmed has two values associated with it; Water On/Off and the Depth of Water applied. If either one of these is manually changed by the operator when the pivot is in that area, the “PrOFF” message will be displayed which indicates “Programs are OFF”.

To enable the program again, turn the program “ON” as explained on page 20.

NOTE: To get rid of the flashing “PrOFF” message, press the SELECT button. Keep in mind that ALL areas programmed are inactive when this message is flashing. The Program feature has been turned off.

EXAMPLE 2 – Running A Pivot Dry (Without Water) Over A Specified Area

Figure 2.37 illustrates a situation in which the operator wants to accomplish the following:

Current conditions in EXAMPLE 2:

- Machine is located at 45 degrees

Operator wants to program the pivot to:

- Turn the water off and travel at 100 percent between 180 and 225 degrees (set aside acres)
- Apply 0.75 inches of water on the soybeans between 225 and 0 degrees.
- The operator will not program the corn area between

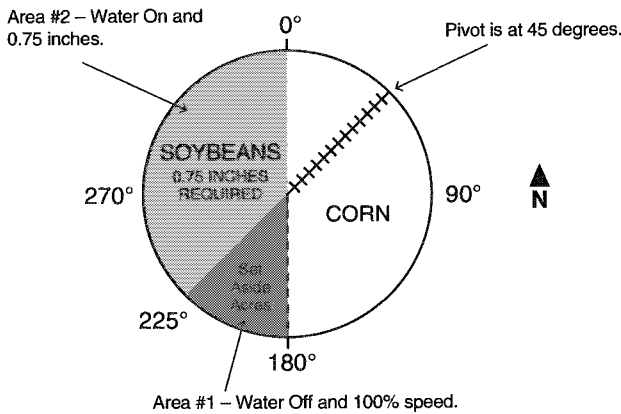

Figure 2.37

Area #1 (Set Aside):	Area #2 (Soybeans):
On (Start) Angle = 180°	On (Start) Angle = 225°
Off (Stop) Angle = 225°	Off (Stop) Angle = 0°
Water Off at 100% speed	Water On and 0.75 inches water

In this example, the operator will program two areas:

Area #1

- Start at 180 degrees
- Stop at 225 degrees
- Turn Water Off and set speed to 100% in between this area

Area #2

- Start at 225 degrees
- Stop at 0 degrees
- Set Water Application at 0.75 inches in between this area

For Your Information:

If both areas are programmed as previously described, then whenever the pivot is started (at 45 degrees in this example), it will NOT be under programmed control since the pivot is not located in a programmed area. The operator can make changes to the pivot in this area without turning the program feature off. As soon as the pivot travels into area #1 or area #2, it is then under Programmed Control. When the pivot enters area #1, the water will be shut off and the pivot will travel at full speed (100%). When the

pivot enters area #2, the water will be turned back on and water application depth will be set at 0.75 inches. If the pivot is in either area #1 or #2 and the operator either changes the Water On/Off status or the amount of water being applied, the program feature is turned off automatically and the operator must turn the program on again if desired. This allows the operator to manually override the program at any time.

To program Example – 2, access SETUP Group 2 by pressing the SETUP button for at least 4 seconds and then releasing it. After 2 seconds the operator will see the Stop In Slot setting screen. Two seconds thereafter, the screen in figure 2.38 will be displayed:

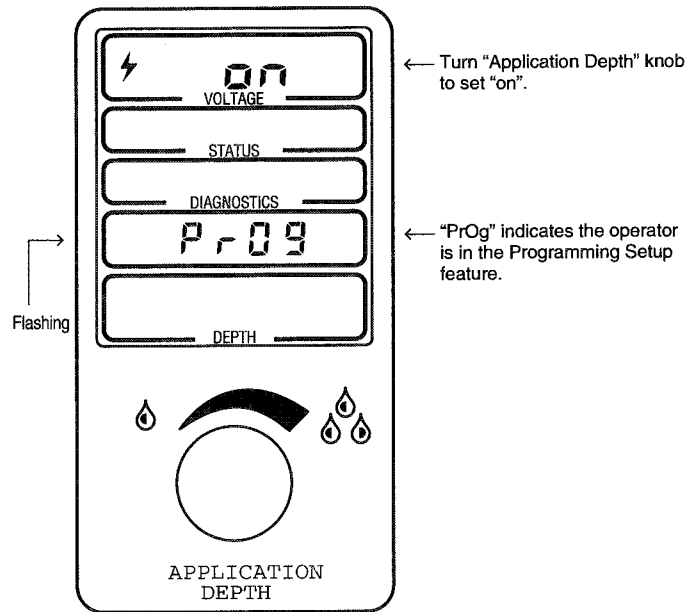
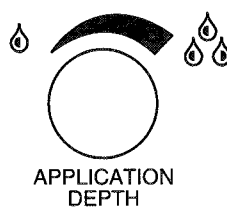

Figure 2.38

The program feature must be initially turned on to be active. The operator can, at any time, turn the feature off and return to manual or normal operating mode by setting the status in figure 2.38 to “OFF”.

To enable (or turn ON) the programming feature, follow steps 1 and 2.



1. Turn the Application Depth knob either to the right or left. Each “click” of the knob will change the setting in the top screen from “OFF” to “ON” or vice versa.



2. Press the SELECT button to save the on/off setting selected in step #1. The screen in figure 2.39 will be displayed.

Select Panel Set Up

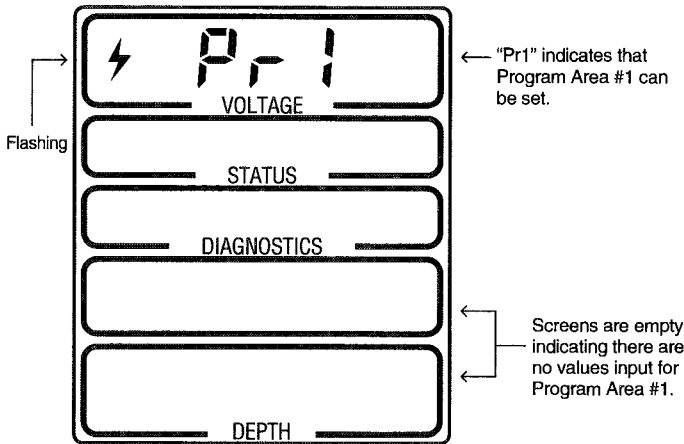

Figure 2.39

"Pr1" indicates the operator is now ready to set up area #1. Remember, each area which is entered will consist of 3 steps:

1. Define the start (or ON) angle of the area.
2. Set the appropriate water depth value or speed and set Water ON or OFF.
3. Define the end (or OFF) angle of the area.

The chart in figure 2.40 will help explain the values which need to set for Example 2.

Area #	Start or ON Angle (degrees)	Depth of Water (IN)	Water ON	Water OFF	Stop or OFF Angle (degrees)
1 (set aside acres)	180			100% Speed	225
2 (soybeans)	225	0.75	X		0

Figure 2.40

To program area #1, follow steps #1 through #6.

1. Turn the Application Depth knob to select the value of the start or "ON" angle for area #1 (180 degrees in this example).

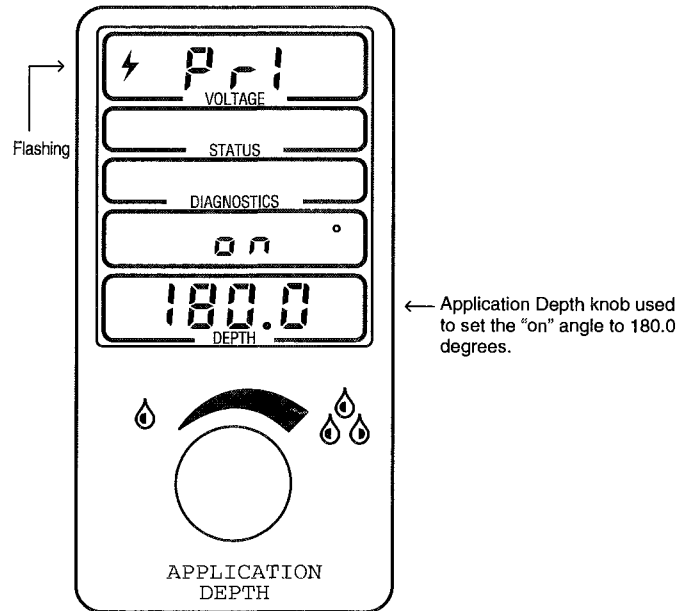

Figure 2.41



2. Press the SELECT button when the desired "on" or start angle for area #1 has been selected. Pressing SELECT saves the value and allows the operator to set the speed to 100% and run the machine dry.

Pressing the SELECT button in step #2 will display the screen in figure 2.42. Notice that figure 2.42 initially displays 0.00 inches of water at a percent timer setting of 50 percent. Since "0.00 inches" is displayed, this indicates that "Water Off" is already selected. Remember, "Water Off" is the initial factory setting.

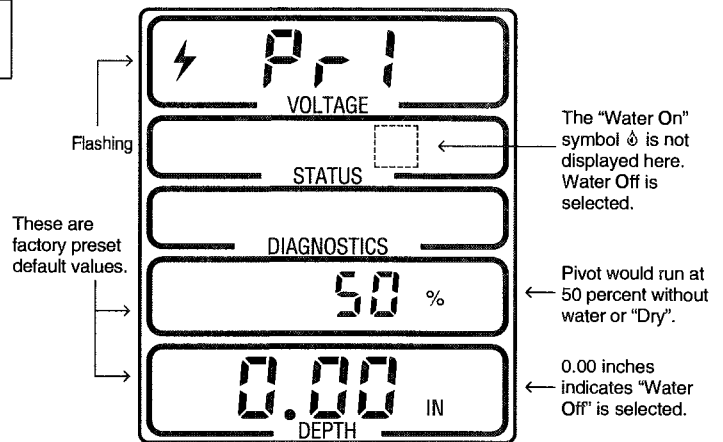

Figure 2.42

Since Water Off is already selected in figure 2.42, the operator only has to set the speed (100% in this example which means the end tower of the pivot will run continuously).

3. To set the speed at 100%, turn the “Application Depth” knob clockwise to increase the value to 100% as illustrated in figure 2.43.

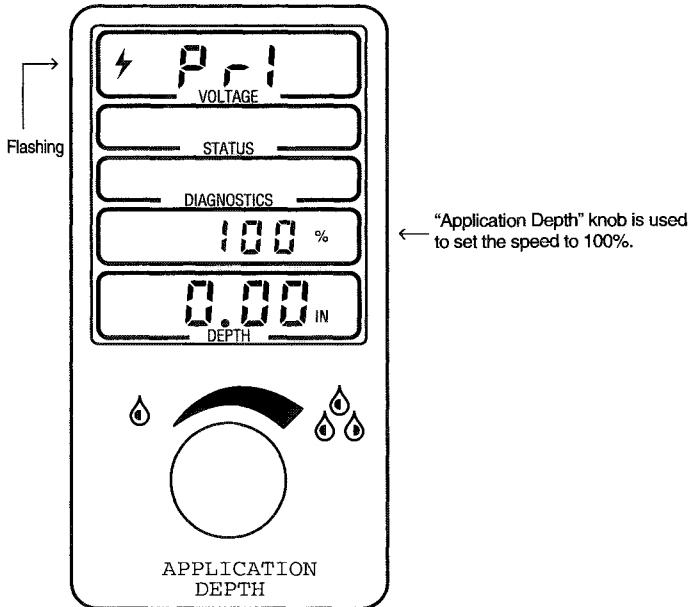

Figure 2.43



4. Press the SELECT button to set the “OFF” or Stop angle for area #1.

5. Turn the knob clockwise to set the “OFF” angle to 225 degrees as illustrated in figure 2.44.

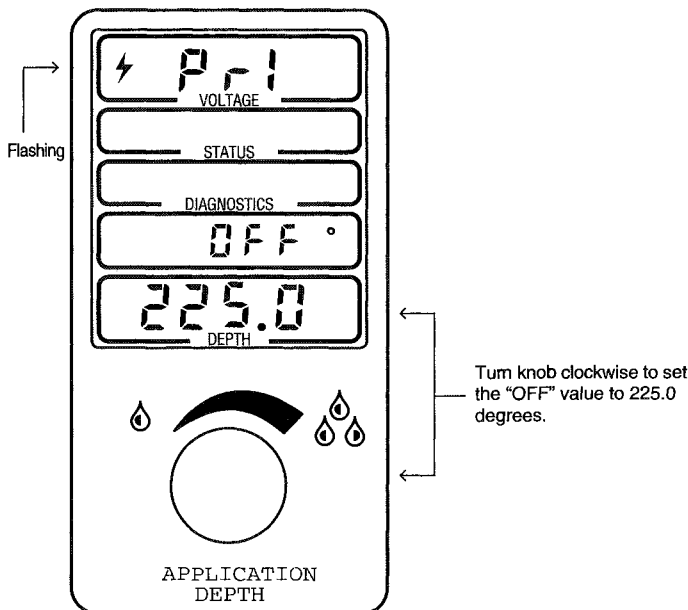

Figure 2.44



6. Press the SELECT button to set the “OFF” or Stop angle for area #1 in step #5.

Pressing the SELECT button in step #6 displays the screen in figure 2.45. Notice that “Pr2” is now displayed in the top screen. The operator is now ready to input the settings for area #2.

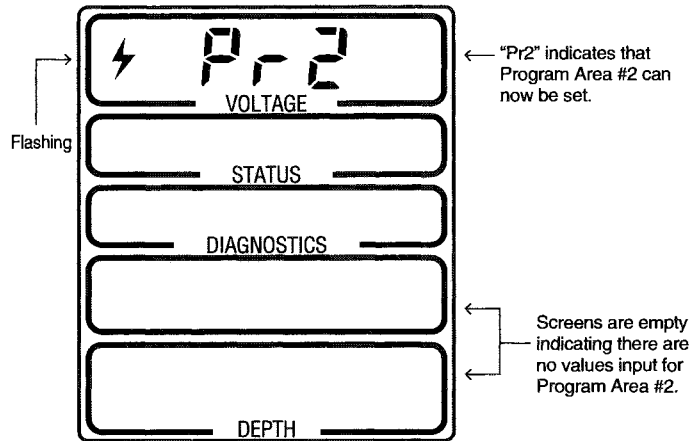

Figure 2.45

7. Repeat the previous steps #1 – #6 to enter the remaining values for area #2 (soybeans).

REMEMBER: Water On must be selected for Area #2 and then the water application depth must be set to 0.75 inches.

To exit after area #2 has been entered, the operator has 2 choices:

- Keep pressing the SELECT button to by-pass areas #3 – #6. This will exit the operator out of the SETUP mode and back to the main screen.

or

- Press the SETUP button. This will exit the operator immediately to the main screen and will save the values just entered.

How This Program Operates In The Field

The operator will start the pivot applying 1.00 inch of water.

If the pivot is started in the forward or clockwise direction, the water supply will be shut off and the speed will be increased to 100% when the pivot enters area #1 (set aside acres). When the pivot leaves area #1 and enters the soybeans, the water supply will be turned back on and the water application depth will be set to 0.75 inches. The water application depth will be changed back to 1.00 inch when the pivot travels into the com again (1.00 inch was the setting initially entered by the operator when the pivot was first started).

Overriding the Program

The operator can override the program by manually turning the “Application Depth” knob. The screen in figure 2.46 will be displayed if this occurs.

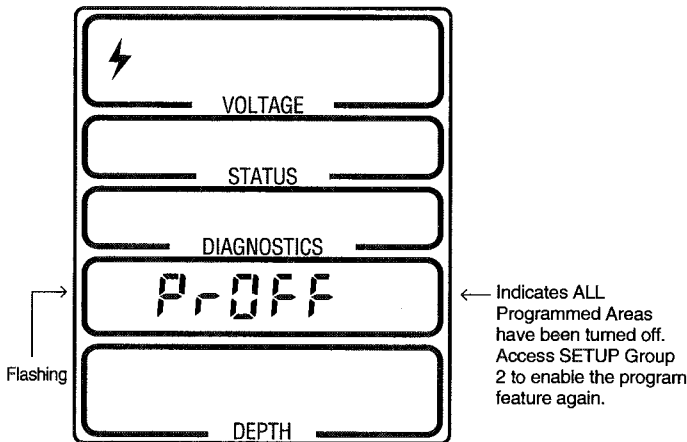

Figure 2.46

Notice that “PrOFF” will flash in the second screen from the bottom. This indicates that **ALL** programmed areas have been turned off because the operator has manually overridden the values in one of the programmed areas. Each area programmed has two values associated with it; Water ON/Off and the Depth of Water applied. If either one of these is manually changed by the operator when the pivot is in that area, the “PrOFF” message will be displayed which indicates “Programs are OFF”.

To enable the program again, turn the program “ON” as explained on page 20.

NOTE: To get rid of the flashing “PrOFF” message, press the SELECT button. Keep in mind that ALL areas programmed are inactive when this message is flashing. The Program feature has been turned off.

SETUP GROUP 3

The following values can be set within SETUP Group 3:

- Low Pressure
- Pressure Delay
- Power Restart Delay
- Percent Timer Cycle

To access SETUP Group 3, press the SETUP button for at least 6 seconds and release. After 2 seconds the operator will see the Stop In Slot setting screen. Two seconds thereafter, the

Programming On/Off screen of Group 2 will be displayed. After approximately a total of 6 seconds, the screen in figure 2.47 will be displayed indicating the operator is in SETUP Group 3.

Low Pressure Setting

The Select Panel can utilize a pressure transducer which will measure the water pressure at the point of installation and display the reading as illustrated in figure 2.47. The pressure reading can be displayed in PSI (English) or KPa (Metric). This pressure reading is then used to shut the pivot down if the pressure drops below a set low pressure point which is user defined.

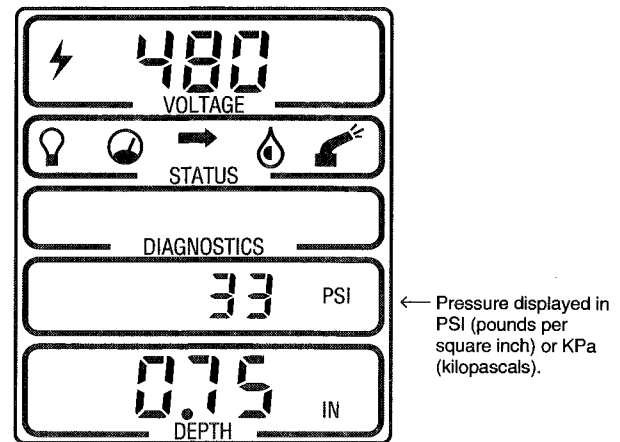

Figure 2.47

A low pressure setting is required to shut the machine down if the operating pressure, at the point of the pressure transducer installation, drops below the low pressure limit setting. For example, assume the low pressure setting is at 20 psi (138 KPa). If the pressure drops below 20 psi (138 KPa), the machine will be shut down.

The Low Pressure Setting is also used during start up of the machine.

When the machine is started, it will not move until the the water pressure reaches the low pressure setting.

The following screen will be displayed after accessing Group 3. The screen in figure 2.48 indicates that the Low Pressure Setting value can be changed and is currently set at 15 psi.

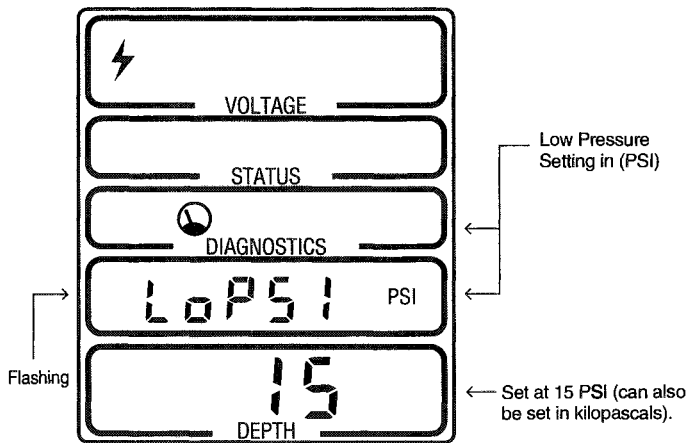

Figure 2.48



1. Turn the knob to adjust the low pressure setting. Remember, the value from the factory is set at 15 psi (103 KPa).



2. Press SELECT to save this value and change/view the next value which is the Pressure Delay setting.

NOTE: A mechanical low pressure switch can also be utilized with the Select Panel. In this case, the pressure reading is not displayed on the screen and the low pressure setting is set at the switch and not from the panel.

Pressure Delay

The pressure delay value is the amount of time required (in minutes) for the machine to develop pressure above the low pressure point after the pump has been started or the water valve has opened. If the pressure has not reached the low pressure point after the specified number of minutes entered in the pressure delay, the machine will shut down due to low pressure. In summary, the pressure delay value bypasses the pressure transducer for a specified amount of time to allow sufficient water pressure to develop in the machine. During this delay period, the machine will not run until water pressure has developed in the machine.

The screen in figure 2.49 will be displayed after changing the previous “Low Pressure setting” value. Follow steps 1 and 2 to change the factory set value of 10 minutes.

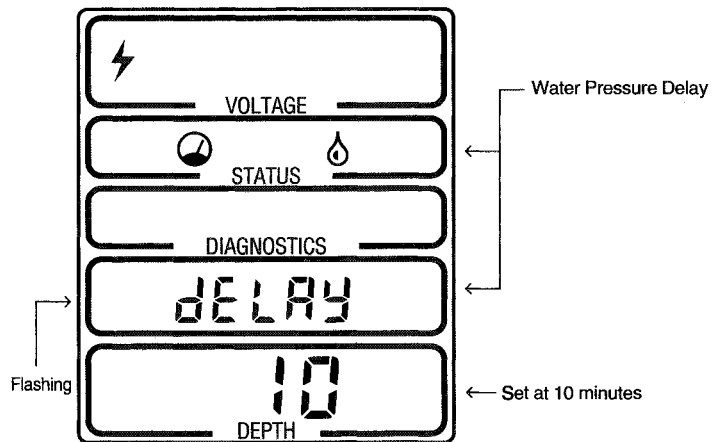
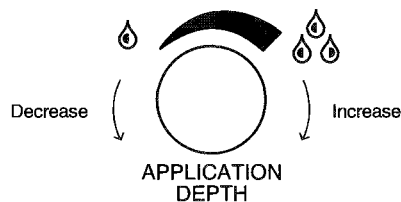

Figure 2.49

NOTE: The value from the factory is 10 minutes for the pressure delay setting. To change the value, go to step 1. If the user wishes to keep the 10 minute value, simply press the SELECT button to enter the next value (which is Power Restart Delay) and the panel will keep the 10 minute value.

1. Turn the Application Depth knob to the right (clockwise) to increase the value or the left (counter clockwise) to decrease the value.



2. When the desired value has been selected, press the SELECT button to save and change/view the next value.



← Press SELECT to save and advance to the next value.

Power Restart Delay

The Select Panel features a standard automatic restart. If a machine stops due to a loss of water pressure or power and either (pressure or power) are restored, the machine will restart automatically if the auto restart feature is switched on. It will also restart using the same running conditions as when it lost pressure or power.

A restart due to regaining pressure is immediate. The machine will start as soon as the water pressure reaches the low pressure set point. However, a time delay can be set for restarts due to power being restored. The time delay can be set for 0-99 minutes. This value is initially set at 0 minutes.

For example, assume that the auto restart feature was on and the time delay was set for 10 minutes. If a machine was running and power was interrupted for a period of time and then restored, the machine would wait 10 minutes before restarting following restoration of power.

CAUTION: During the 10 minute delay period, “dELAY” will be flashing on the main display screen indicating the machine will start automatically after the delay period has expired. If you see “dELAY” flashing be aware that the machine may restart at any time!

The screen in figure 2.50 will be displayed after the previous “Pressure Delay” setting has been set. Follow steps 1 and 2 to set the correct value for the Power Restart Delay.

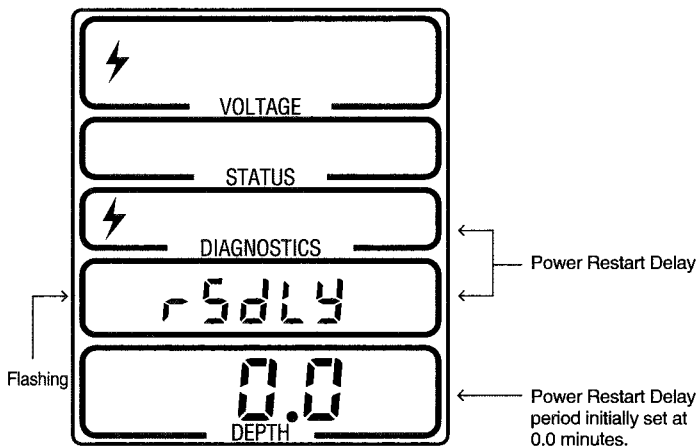

Figure 2.50

NOTE: “rSdLy” will be displayed which represents “Automatic Restart Delay Period”. The “lightning symbol” is used to represent “power” restart delay. The value for the delay period will also be displayed in the bottom screen. This value will initially be set at 0.0 minutes.



1. Turn the Application Depth knob to the right (clockwise) to increase the value of the Automatic Power Restart Delay Period.



2. When the desired value for the Power Restart Delay Period has been selected in minutes, press the SELECT button to save and change/view the next value which is the Percent Timer Cycle setting.

Percent Timer Cycle

The Select Panel is factory set for a 60 second cycle percent timer. This means that if the percent timer is set at 50 percent, the end tower will move 30 seconds (or 50%) of each minute. The percent timer cycle for the Select Panel can be field set at either 30, 60 or 120 seconds, with 60 seconds being the standard setting.

For example, the operator may want to utilize a 30 second cycle percent timer. In this case, the end tower will run 15 seconds out of each 30 seconds at a 50% setting. This provides a shorter run time of the last regular drive unit which is helpful for sprinkler packages with a narrow wetted diameter.

A 120 second cycle may be useful when an operator runs the machine at very low percentage timer settings such as 5 or 10 percent. This will decrease the last drive unit motor starts and stops. However, if 120 seconds is used at higher percentage timer settings, the water uniformity may be adversely affected because the machine will move greater distances than with a normal 60 second setting. Contact your local Valley dealer if you have any questions concerning this topic. If in doubt, use the standard 60 second cycle setting.

The screen in figure 2.51 is displayed after entering the Power Restart Delay Setting discussed previously. Notice that “PER” is displayed to represent Percent Timer Cycle. The value for the percent timer cycle will be displayed in the bottom screen. The standard percent timer cycle will initially be set at 60 seconds.

To change the percent timer cycle, follow steps 1 and 2.

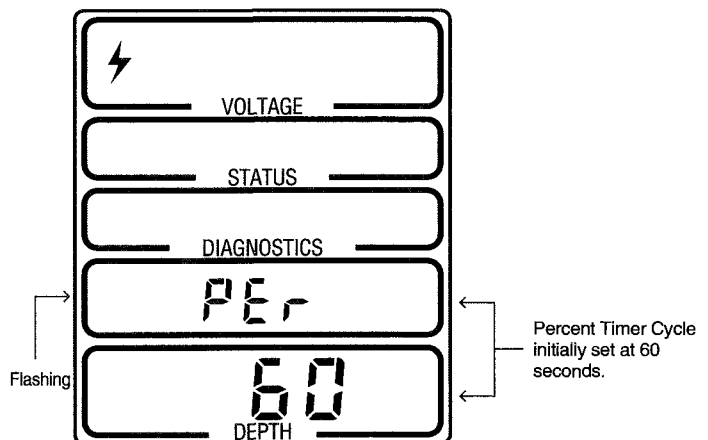
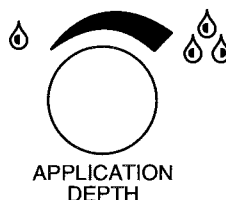

Figure 2.51



1. Turn the Application Depth knob to the right (clockwise) to increase the cycle to 120 seconds. Turn the Application Rate knob to the left (counter-clockwise) to decrease the cycle to 30 seconds.



2. Press SELECT to save the value selected in step #1. The operator will be returned to the normal operating screen.

SETUP GROUP 4

The following values can be set within SETUP Group 4:

- Minimum (Low Application)
- Minimum Hours Per Revolution
- Voltage Calibration
- Low Voltage Setting
- Auto Reverse/Stop Enable
- Forward and Reverse Positions
- Auto Reverse/Stop Delay Period
- Direction Offset
- Engine Control On/Off
- English or Metric Units
- Baud
- Password

To access SETUP Group 4, press the SETUP button for at least 8 seconds and release. The operator will notice screens of groups one, two and three appear before seeing the screen in figure 2.53. It will take approximately 8 seconds for the screen in figure 2.53 to appear.

Minimum (Low) Application

The Minimum (Low) Application is the amount of water applied at a percentage timer setting of 100 percent. A percentage timer setting of 100 percent indicates the end tower of the machine will run continuously providing the operator with the minimum revolution time. The Minimum (Low) Application value is important because it is used to calculate water applications at different percentage timer settings. The minimum water application value can be determined by looking at the sprinkler chart for the machine as displayed in figure 2.52.

	INCHES PER REVOLUTION	PERCENT TIMER SETTING	HOURS PER REVOLUTION
	.15	100	21
Minimum Application = 0.15 Inches.	.20	77	28
	.30	51	41
	.40	39	55
	.50	31	69
	.60	26	83
	.70	22	96
	.80	19	110
	.90	17	124
	1.00	15	138
	1.25	12	172
	1.50	10	207
	1.75	9	241
	2.00	8	276
	2.50	6	345
	3.00	5	413
	3.50	4	482

Figure 2.52

The sprinkler chart in figure 2.52 indicates that the minimum application is 0.15 inches. It is important to note that this value is at 100 percent water application efficiency. If the machine is 85% efficient in applying water (85 percent of the water actually enters the soil), then the value should be entered as $0.15 \times 0.85 = 0.13$ inches instead of 0.15 inches. Typical efficiencies for center pivot irrigation machines range from 80 to 90 percent depending on the type of sprinkler package and weather conditions. Contact your Valley dealer for a typical efficiency of your machine.

The following screen will be displayed after accessing Group 4. The screen in figure 2.53 indicates that the Minimum Application value can be changed.

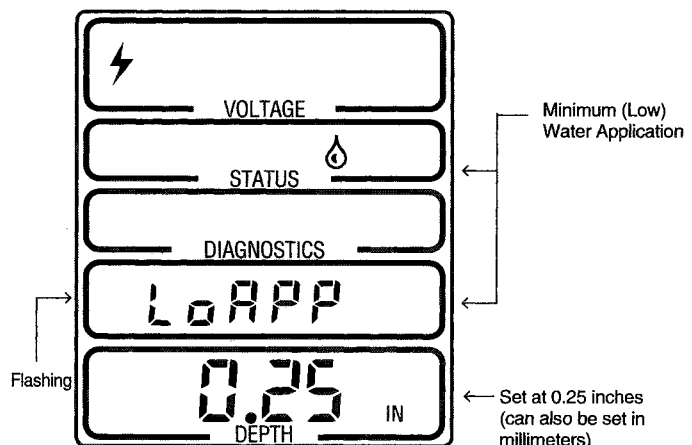
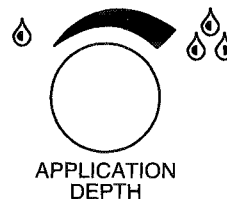

Figure 2.53



1. Turn the Application Depth knob to the left to decrease the value to 0.13 (or the appropriate value). Notice that the value from the factory will initially be set at 0.25 IN.



2. Press SELECT to save and change/view the next value which is Minimum Hours Per Revolution.

Minimum (Low) Hours Per Revolution

Minimum Hours Per Revolution is the number of hours required for the pivot to make 1 complete revolution at a percentage timer setting of 100 percent (maximum speed of the pivot). This value is then used to calculate the hours per revolution for different percentage timer settings. **REMEMBER: the percentage timer setting regulates the amount of water being applied when "Water On" is selected and regulates the speed when "Water Off" is selected.**

The "Minimum Hours Per Revolution" value can be determined by looking at the sprinkler chart for the machine as displayed in figure 2.54. The sprinkler chart in figure 2.54 indicates that the minimum hours per revolution is 21.0 hours.

INCHES PER REVOLUTION	PERCENT TIMER SETTING	HOURS PER REVOLUTION
.15	100	21
.20	77	28
.30	51	41
.40	39	55
.50	31	69
.60	26	83
.70	22	96
.80	19	110
.90	17	124
1.00	15	138
1.25	12	172
1.50	10	207
1.75	9	241
2.00	8	276
2.50	6	345
3.00	5	413
3.50	4	482

Minimum Hours Per Revolution = 21.0 Hours.

Figure 2.54

The following screen in figure 2.55 will be displayed after previously entering the "Minimum (Low) Application" value. The "Minimum Hours Per Revolution" value can be set in tenths of an hour by turning the "Application Depth" knob.

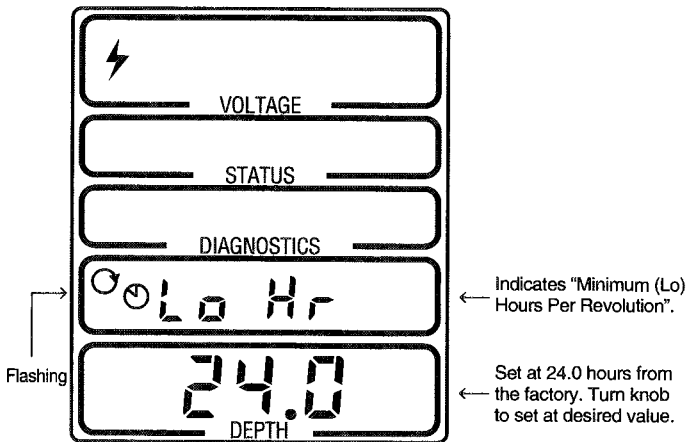

Figure 2.55

1. Turn the Application Depth knob to the left to decrease the value to 21.0 hours (or the appropriate value). Notice that the value from the factory will initially be set as 24.0 hours.



2. Press SELECT to save and change/view the next value which is Voltage Calibration.

Voltage Calibration

The incoming voltage to the panel will be measured with a volt meter by your Valley dealer. This will be entered as the initial VOLTAGE value and calibrates the built-in volt meter in the panel. If this process is not performed, the voltage reading on the display screen may not be correct.

The following screen will be displayed after entering the Minimum Hours Per Revolution value. The screen in figure 2.56 indicates that the value for the Voltage setting can be changed. Let's assume that the incoming voltage has been measured to be 487 volts. The voltage displayed in figure 2.56 may be different than the measured value as is the case in this example.

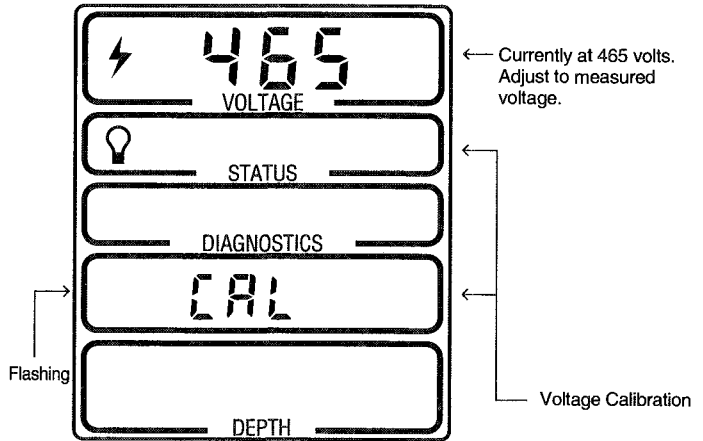
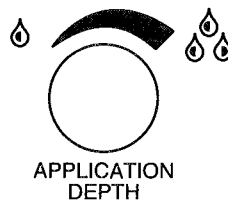

Figure 2.56



1. Turn the knob to adjust the voltage calibration value in figure 2.56 to match the measured value from the volt meter. (487 volts in this example).



2. Press SELECT to save and change/view the next value which is the Low Voltage Setting.

Low Voltage Setting

The Select Panel has a standard low voltage shutdown feature. Incoming voltage at the control panel lower than 440 volts, will shut the machine down.

The low voltage setting can be set higher or lower than the standard 440 volt setting.

CAUTION: Low Voltage (less than 440 volts) WILL damage the drive motors and the problem should be corrected before resuming operation.

The screen in figure 2.57 will be displayed after previously entering the Voltage Calibration value. Notice that the power symbol and “Lo” are displayed to indicate a low voltage setting. The current value for the low voltage setting will be in the top screen labeled “VOLTAGE”. To change the standard 440 volt setting, follow steps 1 and 2.

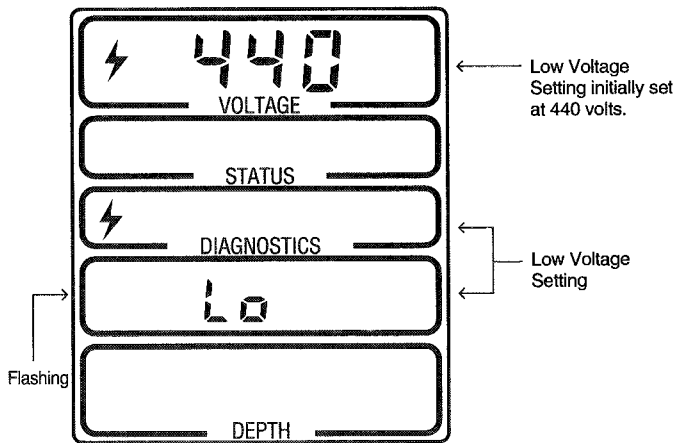
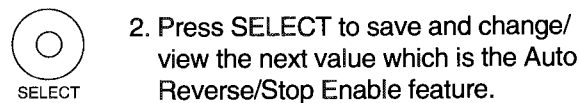
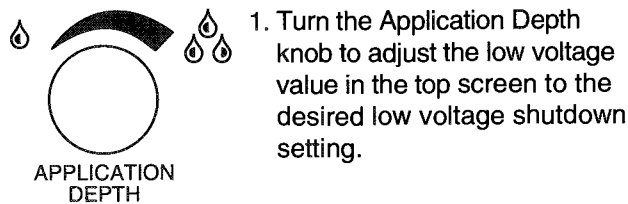

Figure 2.57



Auto Reverse/Stop Enable

The Select Panel offers the operator two different ways in which the pivot can be automatically stopped or it’s direction of travel changed. These include:

OPTION I – Drive Unit Mounted Auto Reverse/Auto Stop (see figure 2.58)

OPTION II – Operator Programmed Reverse and/or Stop Positions

Regardless of which option the operator chooses, the Auto Reverse/Stop Enable value **MUST** be turned **ON** for either option to be active. Following is an explanation of each option so the operator fully

understands each one and what is required to activate it. A procedure for turning the Auto Reverse/Stop feature on (or enabling it) will also be described following the explanations of each option.

OPTION I – Drive Unit Mounted Auto Reverse/Auto Stop

Drive Unit Mounted Auto Reverse/Auto Stop illustrated in figure 2.58 is an option which can be purchased to automatically stop the pivot or change it’s direction of travel. Two different options can be purchased, one which only stops the pivot (Drive Unit Mounted Auto Stop) and one which will both stop and change the pivot’s direction of travel (Drive Unit Mounted Auto Reverse/Auto Stop).

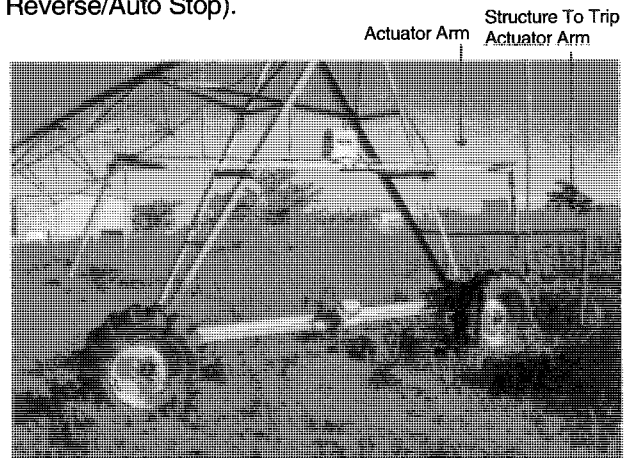

Drive Unit Mounted Auto Reverse/Auto Stop Option

Figure 2.58

IMPORTANT: If the pivot or linear needs to reverse around or stop at a physical obstacle (such as a tree line, building, grain bin, etc.) it is required that the Drive Unit Mounted Auto Reverse/Stop option must be purchased and installed including a physical barricade as illustrated in figure 2.58. See your Valley dealer for more information concerning this matter.

The assembly illustrated in figure 2.58 is used for both drive unit mounted auto stop and drive unit mounted auto reverse/auto stop (combined options). The auto stop option will stop the pivot when the actuator arm contacts the “trip structure”. If the auto reverse/auto stop option is installed, the operator may choose to either stop the machine when it reaches the “trip structure” or have the machine automatically change it’s direction of travel and continue to run. This can be selected with the Auto Reverse/Auto Stop Switch as illustrated in figure 2.59.

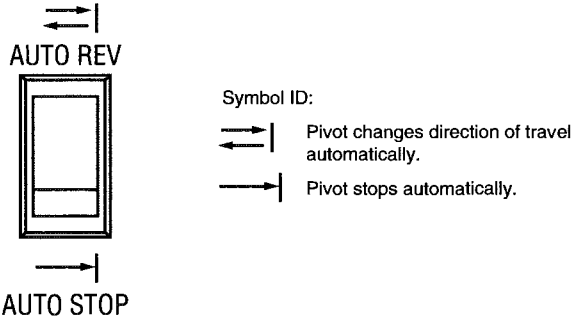

Figure 2.59

Points to Keep in Mind with Option I:

- If drive unit mounted auto stop or auto reverse/stop has been installed on the pivot as an option, then the operator must also enable this feature as explained in this section. This allows the switch in figure 2.59 to be active and causes the machine to change direction if the “Auto Reverse” position is selected.
- If only the drive unit mounted auto stop option has been purchased without the auto reverse feature, then the position of the switch in figure 2.59 does not matter. The pivot will stop when the actuator arm is tripped regardless of the position of the switch.

OPTION II – Operator Programmed Reverse and/or Stop Positions

The Select Panel also offers a programmable feature which allows the operator to select two positions at which the pivot can either be stopped or it’s direction of travel changed. A typical situation is illustrated in figure 2.60.

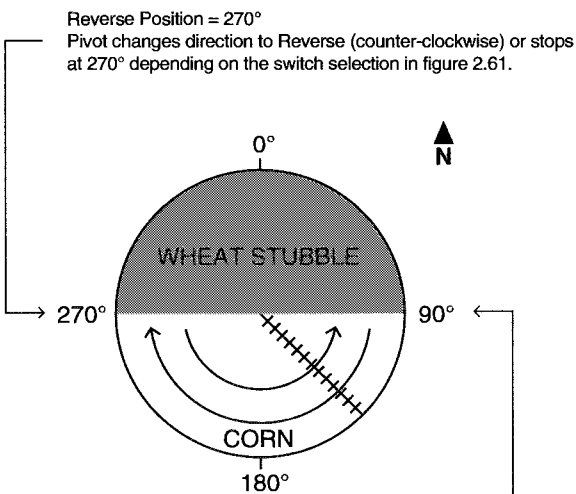

Figure 2.60

Reverse Position = 270°
Pivot changes direction to Reverse (counter-clockwise) or stops at 270° depending on the switch selection in figure 2.61.

Forward Position = 90°
Pivot changes direction to Forward (clockwise) or stops at 90° depending on the switch selection in figure 2.61.

The field in figure 2.60 is an “open” field. There are not any physical obstacles such as a tree line, building, grain bin, etc. which the pivot needs to stop for or change it’s direction of travel at. The operator only wants to apply water to the South half of the field which is corn. In this situation, the Select Panel allows the operator to input two values which can be entered after the “Auto Reverse/Stop” feature has been enabled in this section. These two values are:

Forward Position: Position (in degrees) where the machine changes direction from Reverse to Forward (90 degrees in figure 2.60).

Reverse Position: Position (in degrees) where the machine changes direction from Forward to Reverse (270 degrees in figure 2.60).

The forward value of 90 degrees will cause the pivot to change the direction to forward at 90 degrees. The reverse value of 270 degrees will cause the pivot to change the direction to reverse at 270 degrees.

The auto reverse/auto stop switch illustrated in figure 2.61 determines if the pivot will change it’s direction of travel at the programmed positions or stop it.

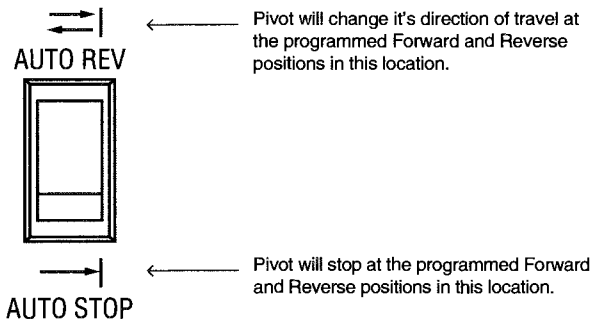

Figure 2.61

IMPORTANT: If the pivot needs to reverse around or stop at a physical obstacle (such as a tree line, building, grain bin, etc.) it is required that the Drive Unit Mounted Auto Reverse/Auto Stop option must be purchased and installed including a physical barricade as illustrated in figure 2.58. The operator programmed feature described previously in this section, must only be used when physical obstacles are not present. See your Valley dealer for more information concerning this matter.

Points to Keep in Mind with Option II:

- This feature requires three items to be input:
 1. Enable the feature (this will be explained next)
 2. Set the Forward Position
 3. Set the Reverse Position

NOTE: Setting Forward and Reverse Positions will be explained in the next section for SETUP Group 4. This section is entitled "Forward and Reverse Positions".

- Remember, this feature **MUST NOT** be used if physical obstacles are present in the field!!!!

The screen in figure 2.62 will be displayed after previously entering the Low Voltage Setting. "Ar-AS" represents the Auto Reverse – Auto Stop feature. "OFF" is displayed in the top screen to indicate the auto reverse/auto stop feature is currently disabled or off. The Auto Reverse – Auto Stop value will be factory preset in the "OFF" mode. **If this feature is not required, leave it in the "OFF" mode.**

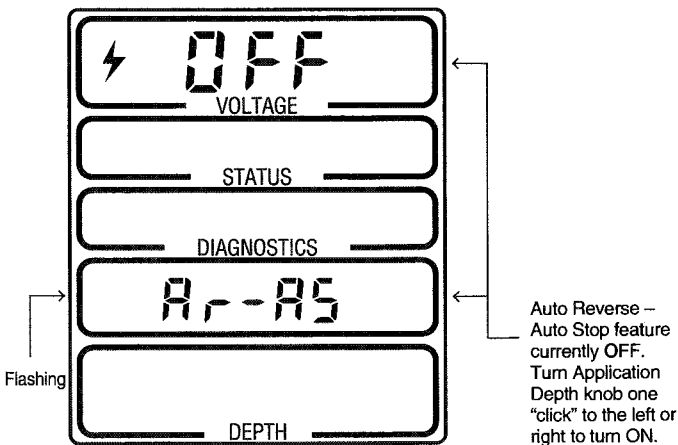
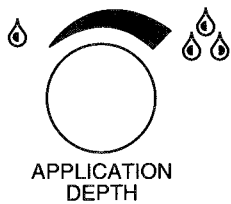

Figure 2.62

To enable the auto reverse/auto stop feature, follow steps 1 and 2.



1. Turn the Application depth knob either to the right or left. Each "click" of the knob will change the setting in the top screen from "OFF" to "ON" or vice versa.



2. Press the SELECT button to save the on/off setting selected in step #1 and change/view the next value which is the Forward Position.

Forward and Reverse Positions

The Forward and Reverse Positions are set only if the operator wants to program positions where the pivot needs to change its direction of travel or stop. A typical situation is illustrated in figure 2.63 and will be used for an example in setting these two positions.

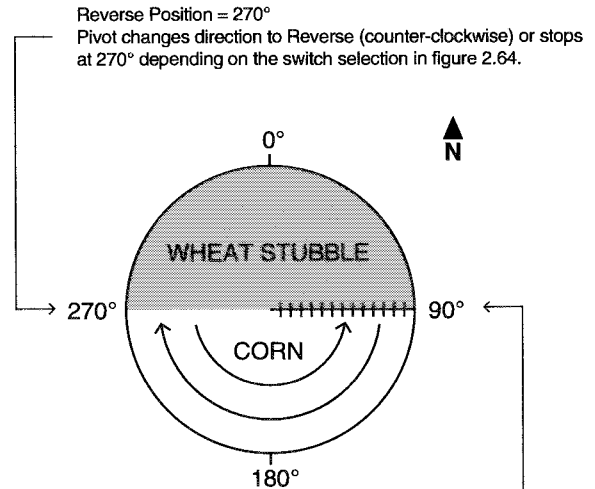

Figure 2.63

Forward Position = 90°
Pivot changes direction to Forward (clockwise) or stops at 90° depending on the switch selection in figure 2.64.

The field in figure 2.63 is an "open" field. There are not any physical obstacles such as a tree line, building, grain bin, etc. which the pivot needs to stop for or change its direction of travel at.

IMPORTANT: If the pivot needs to reverse around or stop at a physical obstacle (such as a tree line, building, grain bin, etc.) It is required that the Drive Unit Mounted Auto Reverse/Auto Stop option must be purchased and installed including a physical barricade as illustrated in figure 2.58. The Forward and Reverse positions programmed in this section must only be used when physical obstacles are not present. See your Valley dealer for more information concerning this matter.

The operator only wants to apply water to the South half of the field which is corn. This requires the Forward and Reverse Positions to be entered as follows:

Forward Position: Position (in degrees) where the machine changes direction from Reverse to Forward (90 degrees in figure 2.63).

Reverse Position: Position (in degrees) where the machine changes direction from Forward to Reverse (270 degrees in figure 2.63).

The forward value of 90 degrees will cause the pivot to change the direction to forward at 90 degrees. The reverse value of 270 degrees will cause the pivot to change the direction to reverse at 270 degrees.

The auto reverse/auto stop switch illustrated in figure 2.64 must be set in the Auto Reverse position. (If the switch is set in the Auto Stop position, the machine will stop at each forward and reverse position, which may be desirable in certain situations).

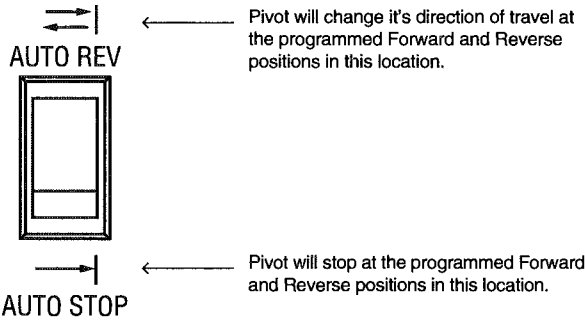

Figure 2.64

The screen in figure 2.65 will be displayed after previously turning the "Auto Reverse/Stop" feature on and pressing SELECT. The "Forward and Reverse Positions" can be set as explained in steps #1 – #4.

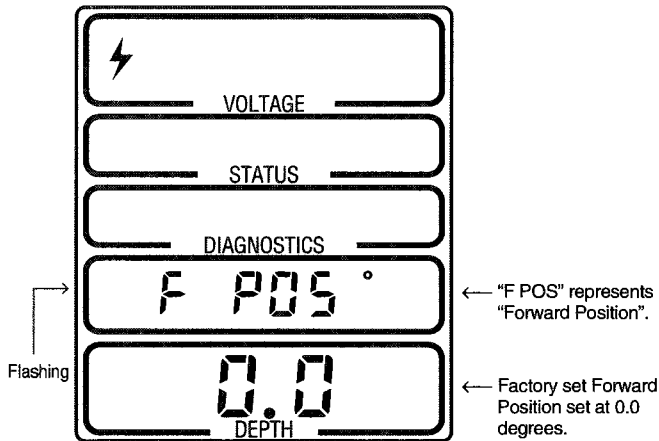

Figure 2.65

1. Turn the knob to adjust the Forward Position to 90.0 degrees.

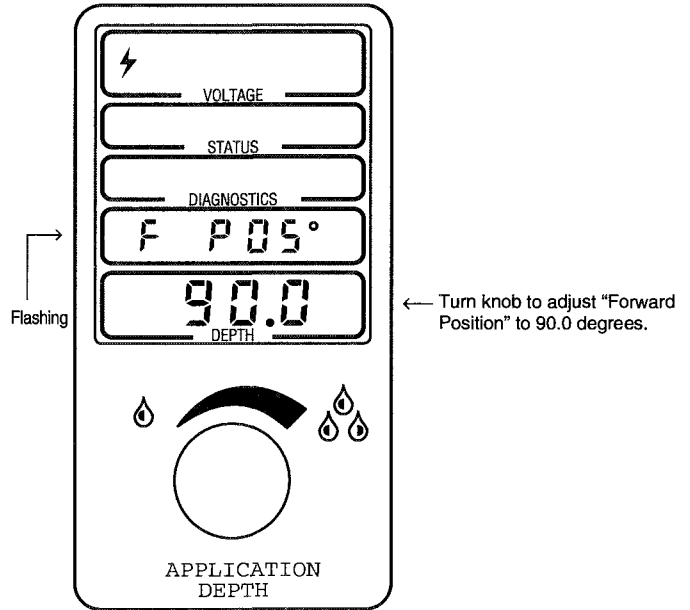

Figure 2.66

2. Press SELECT to save and change/view the next value which is the Reverse Position.

Pressing SELECT in step #2 will display the screen in figure 2.67. Notice that the factory set values for both the forward and reverse positions is 0.0 degrees.

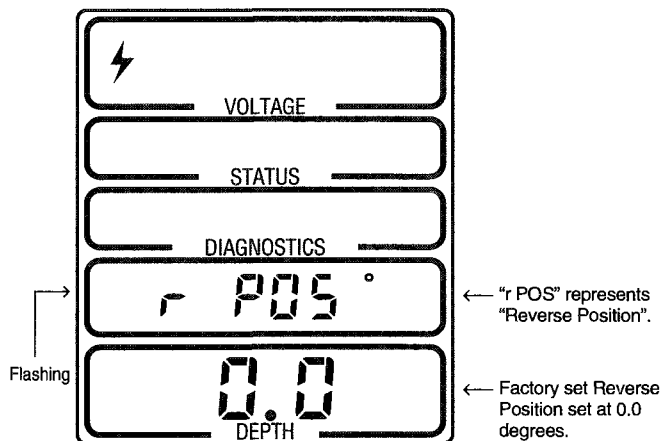

Figure 2.67

- Turn the knob to adjust the Reverse Position to 270.0 degrees.

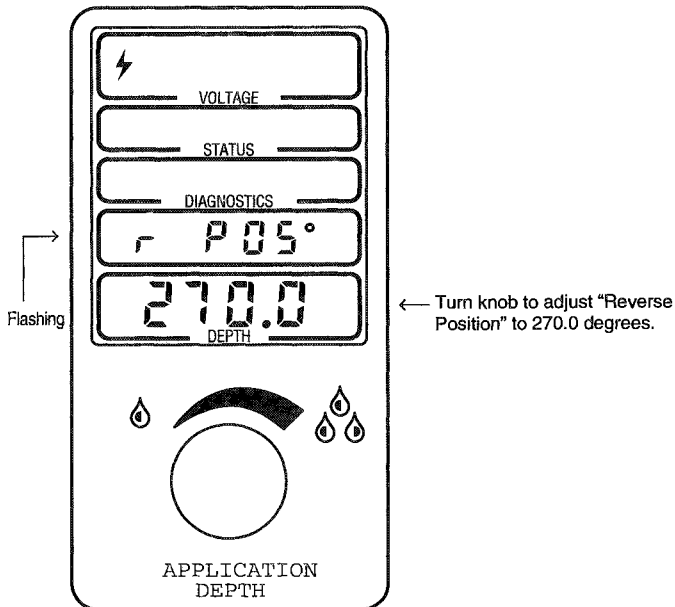

Figure 2.68



- Press SELECT to save and change/view the next value which is the "Auto Reverse/ Stop Delay Period".

Important Points To Remember:

- The Forward and Reverse Positions can be disabled by either turning the Auto Reverse/Stop feature "OFF" as explained earlier or set both the Forward and Reverse Positions to the same value. For example, setting the forward and reverse positions both to 0.0 degrees will disable the Operator Programmed Reverse and /or Stop feature.
- If the Drive Unit Mounted Auto Reverse/Auto Stop option is being utilized, then the operator MUST set the Forward and Reverse Positions to the same value to disable them. If this is not done, then both the Drive Unit Mounted Auto Reverse / Auto Stop and the Programmed Forward and Reverse Positions will be active, which in most situations, would not be desirable.
- If the forward and reverse positions are set so that the pivot is located outside the area of travel, then the machine will not be allowed to start. For example, if the Forward and Reverse positions were switched accidentally (forward = 270 degrees and reverse = 90 degrees), then the Select Panel assumes the area of travel would be the North half of the field (not the south half). If the pivot was located in the South half, it would not be allowed to run and the diagnostics screen would be displayed as follows in figure 2.69.

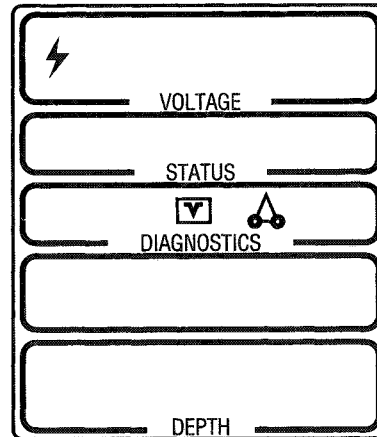

These two symbols will be displayed if the pivot is out of the area of travel defined by the Forward and Reverse Positions. The pivot will not start in this situation.

Figure 2.69

The operator would need to set the correct forward and reverse positions to eliminate this problem.

Auto Reverse/Stop Delay Period

This value can only be set if the Auto Reverse/Stop value discussed previously is set in the "on" mode. A typical field with a pivot which changes it's direction of travel is illustrated in figure 2.70.

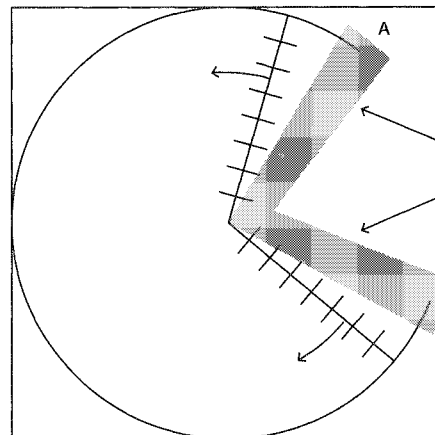

Figure 2.70

The machine will change it's direction of travel or stop at points A and B, depending on whether auto reverse or auto stop has been selected. When a machine changes it's direction of travel or stops at point A or B, the depth of water application is not uniform because the area covered by the sprinklers does not get a chance to travel completely over the reverse or stop point.

The Select Panel utilizes the Auto Reverse/ Stop Delay Period to delay the machine at the reverse/stop points for a period of time. When the actuator arm is tripped to change direction or stop the machine or the pivot changes direction/stops at the programmed Forward or Reverse positions, the machine will water in place for the amount of time specified in the delay

period, which will help improve the water application uniformity at that point. The value for the delay period must be less than the over watering timer setting which is factory set at 12 minutes. The over watering timer is located in the next to last drive unit tower box and can be set from 0-60 minutes.

A typical range of values for the delay period setting is from 10-15 minutes. Remember, if the delay period is set for more than 12 minutes, the over watering timer must be set at a higher value also.

The screen in figure 2.71 is displayed after the Reverse Position has been set. "ArdLy" represents the Auto Reverse Delay Period. The value for the delay period is located in the bottom screen and is factory set at 0.0 minutes.

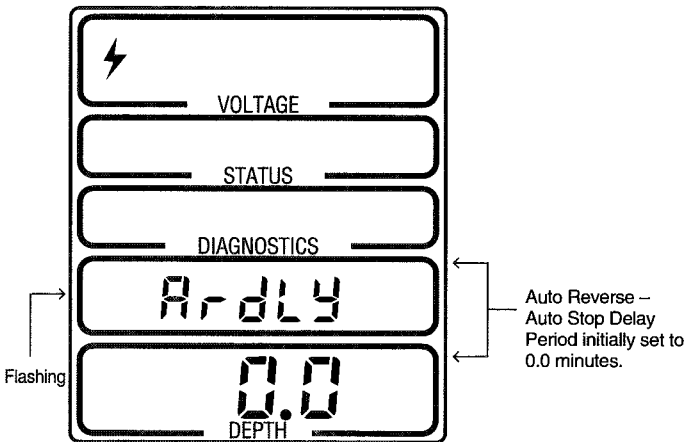
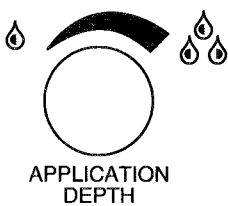

Figure 2.71

Follow steps 1 and 2 to change the value of the Auto Reverse/Stop Delay Period.



1. Turn the Application Depth knob to change the value for the Auto Reverse/Auto Stop Delay Period. Remember – this value must be less than the over watering timer setting.

NOTE: Delay Period setting is in minutes.



2. Press the SELECT button to save the value for the Auto Reverse/Stop Delay Period selected in Step #1 and change/view the next value which is the "Direction Offset".

NOTE: When the pivot changes it's direction of travel or stops due to End of Field Auto Reverse/Stop or the Programmed Forward and Reverse positions, the

pivot will water in place for the amount of time specified in the delay period. During the delay period, the "water on" symbol will be flashing as illustrated in figure 2.72.

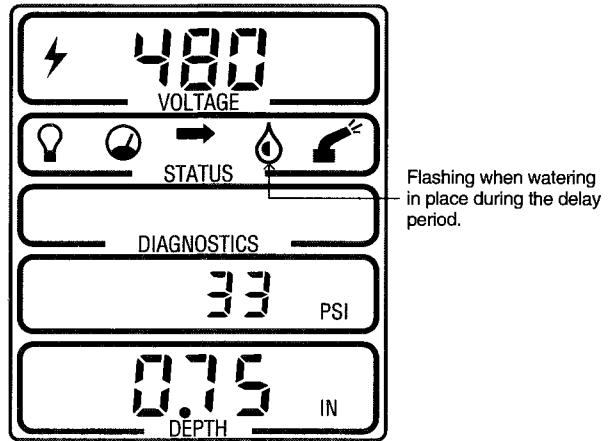

Figure 2.72

Direction Offset

The Direction Offset value is used to adjust the position readings from the resolver so that the end gun, sector control, stop in slot settings and programmed values will repeat at the same position each time around the field. This value is initially set at 1.0 degrees from the factory and normally will not need to be changed. A complete explanation of the Direction Offset is given in Appendix B entitled "Position Accuracy". The operator should NOT change the value of the direction offset until Appendix B is reviewed.

The screen in figure 2.73 will be displayed after previously entering the "Auto Reverse/Stop Delay Period" value. "OFFS" is displayed to represent the direction offset in degrees. The initial value for the direction offset will be set at 1.0 degree as illustrated in the bottom screen of figure 2.73.

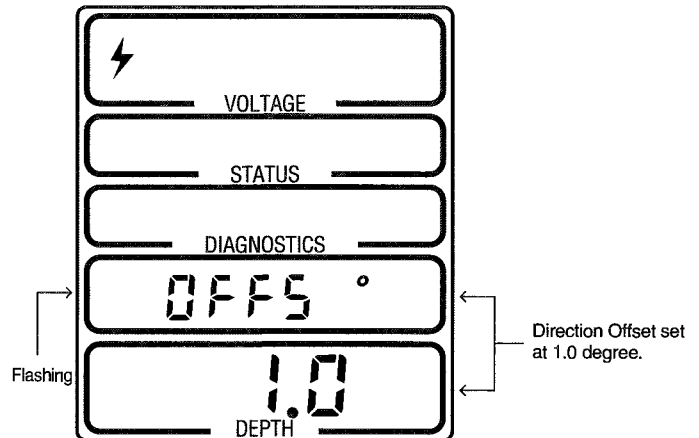
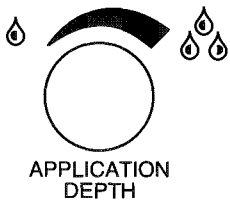
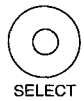

Figure 2.73

Follow steps 1 and 2 to change the value of the direction offset.



1. Turn the Application Depth knob to either increase or decrease the value of the Direction Offset. (The minimum value for the Direction Offset is 0.5 degrees).



2. Press the SELECT button to save the value for the Direction Offset selected in step #1 and change/view the next value which is the Engine Control on/off feature.

Engine Control

This value can be set in either the “on” or “off” mode. If an engine generator set is being utilized for powering the pivot, then selecting the “on” mode allows the pivot to be operated dry (without water). An “on” condition energizes the pump relay in the Select panel when the machine is running in either the “Water On” or “Water Off” mode.

When an engine is utilized, the engine shut down circuit is usually run through the contacts of the pump relay circuit. Therefore, the pump relay must be energized to run the machine in the dry mode if an engine generator set is utilized. If the machine is run by public power, then the engine control should be left in the “OFF” mode. The pump relay is then normally used to turn the pump on and off.

NOTE: If you have any questions regarding how your machine operates in regards to shutdown safeties, contact your Valley dealer.

The screen in figure 2.74 will be displayed after previously entering the “Direction Offset” value. “Eng” is used to represent Engine Control. The initial value for the engine control will be the “OFF” mode.

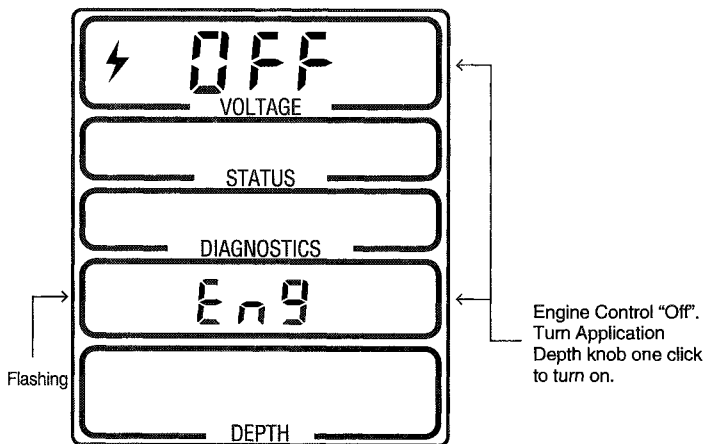

Figure 2.74

Follow steps 1 and 2 to change the “OFF” value to “on” or vice versa:



1. Turn the Application Depth knob one click to the left or right.



2. Press the SELECT button to save the on/off value for the Engine Control selected in step #1 and change/view the next value which is English or Metric Units.

English Or Metric Units

The Select Panel has the capability to display the pressure reading in either pounds per square inch (psi) or kilopascals (KPa). The water application depth screen can also be displayed in either inches (In.) or millimeters (mm). Figure 2.75 illustrates the two sets of units (English and Metric) which can be selected.

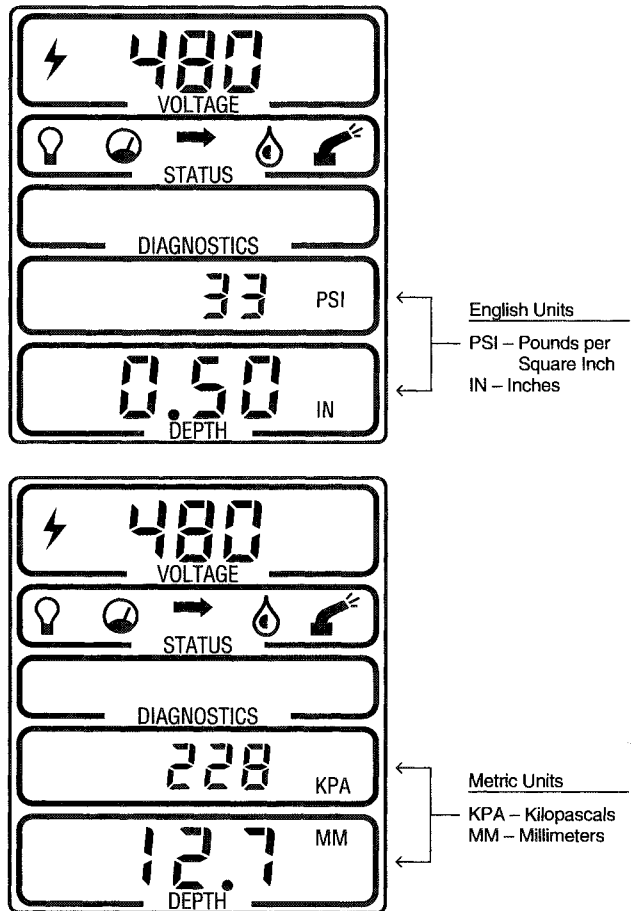
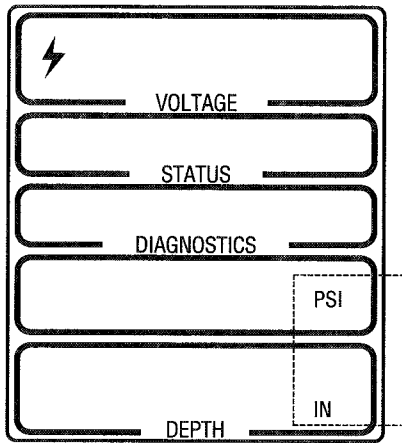

Figure 2.75

NOTE: 1 PSI = 6.89 KPa
1 IN = 25.4 mm

The units will initially be set for English. To change the units to Metric (refer to the lower example in figure 2.76), or back to English, follow steps 1 and 2.



OR

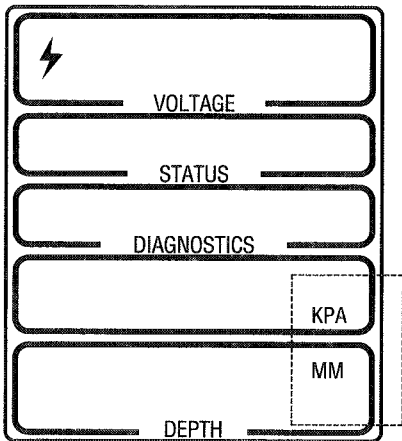
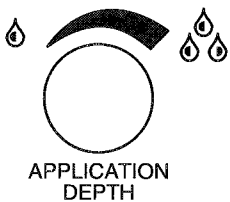

Figure 2.76



1. Turn the Application Depth knob either to the right or left. Each “click” of the knob will change the units from English to Metric or vice versa. If “KPA and MM” are displayed, the units will be Metric representing kilopascals and millimeters respectively.



2. Press SELECT to save the units (English or Metric) selected in step #1, and change/view the next value which is “Baud Rate.”

Baud Rate

Baud indicates the rate information is transmitted and/or received by the center pivot and the remote control unit when the remote telemetry option is used in conjunction with the center pivot installation and its operation. Setting the Baud Rate will be covered in the Remote Link Telemetry Control Owners Manual. Press SELECT to change/view the next input which is “Password.”

Password

Password is used only with the remote telemetry option. Entering passwords or numbers will be covered in the Remote Link Telemetry Control Owners Manual. Press SELECT to return to the main screen. This was the final item in Group 4.

REVIEWING AND EDITING VALUES

It may be necessary to review or change the values previously entered in Setup Groups 1-4. The following sections explain how to do this:

Reviewing Values

1. To review, the operator must be in the appropriate Setup Group. Press the SETUP button for at least 2 seconds for Group 1, 4 seconds for Group 2, 6 seconds for Group 3 or 8 seconds for Group 4.
2. The first value in each group will be displayed first. To review the next value in each group, press the SELECT button.
3. Continue pressing the SELECT button to view the remaining values. Do NOT turn the Application Depth knob unless a value needs to be changed.
4. To quit reviewing, press the SETUP button at any time or continue to press the SELECT button. The operator will eventually be exited out of the Setup group after reviewing the last value in the group.

Changing Values

To change a value in any group, follow these steps:

1. To change a value, the operator must be in the appropriate Setup Group. Press the SETUP button for at least 2 seconds for Group 1, 4 seconds for Group 2, 6 seconds for Group 3 or 8 seconds for Group 4.
2. Continue pressing the SELECT button to advance to the value which needs to be changed.
3. Turn the Application Depth knob to adjust the current value.
4. Press the SELECT button to save the changed setting and to advance to the next value in the group.
5. To exit, press the SETUP button.

Changing End Gun Settings

One of the most common changes are for the initial settings of the end gun on/off angles. For example, let's assume the operator wants to change the end gun settings for sequence #2. Remember, the following end gun settings were initially set in our example:

Sequence #	On Angle	Off Angle
1	300	60
2	120	150
3	210	240

After watching the end gun turn on and off, the operator has determined that the end gun should turn on at 117 degrees instead of 120 degrees and should shut off at 148 degrees instead of 150 degrees.

To make these changes follow these steps:

1. To change the end gun settings, the operator must be in SETUP Group 1. Press the SETUP button for at least 2 seconds.

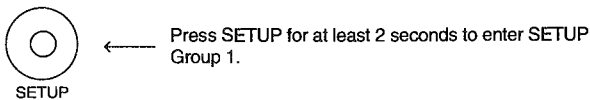

2. Continue pressing the SELECT button to advance to the end gun screen identified as "1Eg - 2" as displayed in figure 2.77. Remember, the "2" in "1Eg - 2" indicates the second end gun sequence which is the one which needs to be changed.

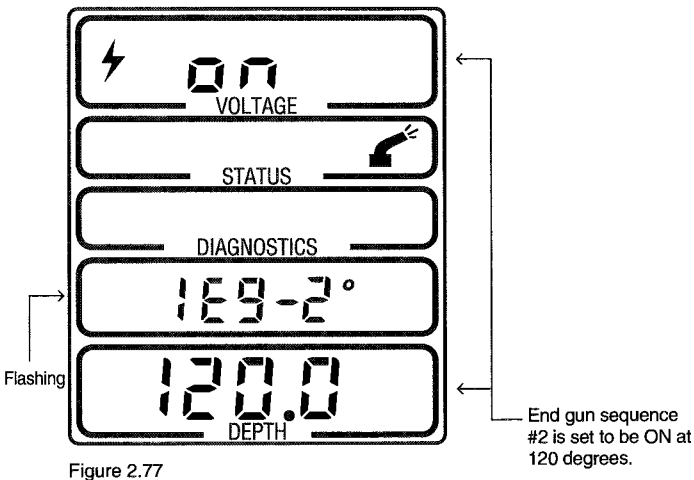

Figure 2.77

The end gun icon is on indicating the operator is in the end gun setting screen. Notice that the top screen indicates the end gun is commanded to turn "on". The bottom screen indicates the degree at which the end gun is commanded on (120.0 degrees.)



3. Turn the Application Depth knob counter clockwise to adjust the on angle for sequence #2 to 117.0 degrees.



4. Press the SELECT button to set the new "on" angle of 117.0 degrees.

The screen in figure 2.78 will be displayed. The "OFF" angle of 150.0 degrees is displayed for "1Eg - 2".

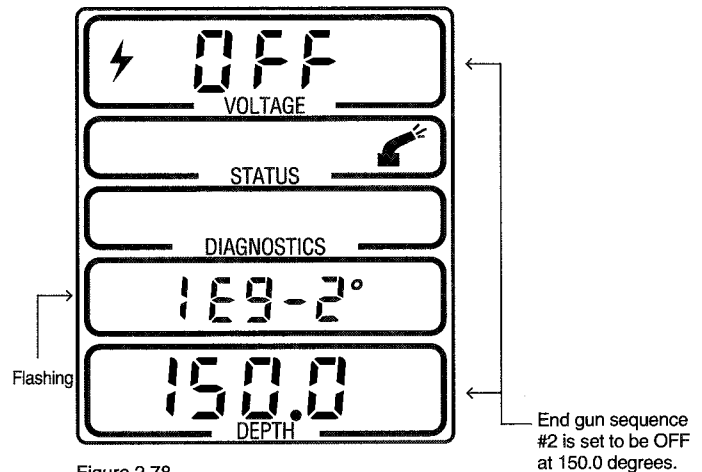
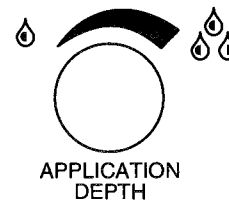

Figure 2.78



5. Turn the Application Depth knob counter clockwise to adjust the off angle for sequence #2 to 148.0 degrees.



6. Press the SELECT button to set the new "OFF" angle of 148.0 degrees.

To exit, press the SETUP button or continue pressing SELECT to review/change the remaining values.

Adding End Gun/Sector Control Settings

It may be necessary to add a sequence to the end gun or sector control settings. The same procedure is used to add sequences as was explained when the end gun or sector control settings were entered the first time. For example, assume an additional sequence for the end gun settings is required in our original example. The operator determined that the end gun must also be turned on between 270 degrees and 290 degrees. This will require a fourth sequence. To add the fourth sequence, follow these steps:

1. To add a sequence to the end gun settings, the operator must be in SETUP Group 1. Press the SETUP button for at least 2 seconds.

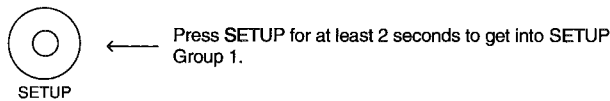

2. Continue pressing the SELECT button to advance to the fourth end gun screen identified as "1Eg - 4°" which is displayed in figure 2.79. Remember, the "4" in "1Eg - 4°" indicates the fourth end gun sequence.

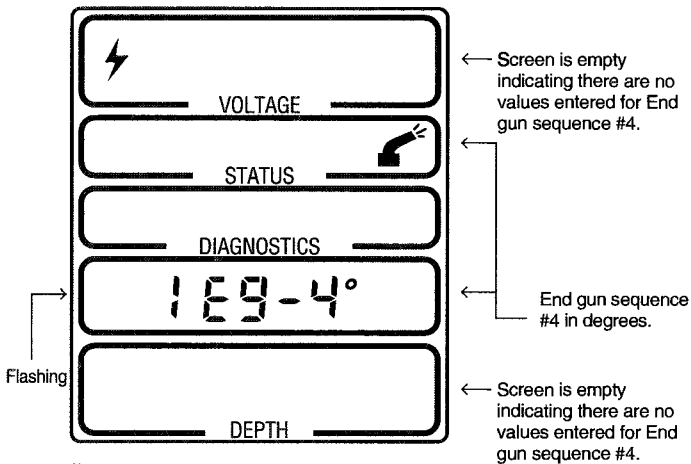
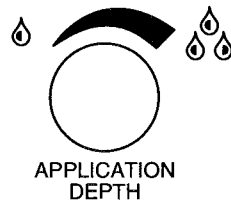

Figure 2.79

Notice that the top and bottom screens are blank. The bottom screen is always used to display the value of the "on" or "off" angle. Since it is blank, this means there are no settings entered for sequence #4.



3. Turn the Application Depth knob to set the desired "on" angle of 270.0 degrees. As soon as the Application Depth knob is turned, the degree value in the bottom screen will start incrementing

from the last "off" value which was input (in this example it would start incrementing from 240 degrees).



4. Press SELECT to set the "on" angle of 270.0 degrees.

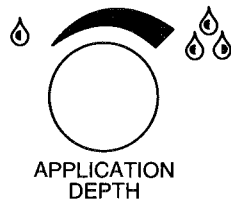

5. Turn the Application Depth knob to adjust the "OFF" value to 290.0 degrees.



6. Press SELECT to set the "OFF" angle of 290.0 degrees.

7. To exit, press the SETUP button or continue pressing SELECT to review/add any other settings.

REMEMBER: The same procedure described in the previous steps #1-7 is used to add a sequence to the sector control settings. In step #2 the operator would press SELECT to advance to the desired sector control setting and then follow the rest of the procedure in steps #3-7.

Deleting End Gun/Sector Control Settings

End gun or sector control settings may need to be deleted. For example, assume that end gun sequence #2 of the original example needs to be deleted. Sequence #2 is as follows:

- 1Eg - 2° on angle = 120 degrees
- 1Eg - 2° off angle = 150 degrees

To delete end gun sequence #2, follow these steps:

1. To delete an end gun or sector control sequence, the operator must be in SETUP Group 1. Press the SETUP button for at least 2 seconds.
2. Press the SELECT button to advance to the second end gun sequence identified as "1Eg - 2°" which is displayed in figure 2.80. Remember, the "2" in "1Eg - 2°" indicates the second end gun sequence.

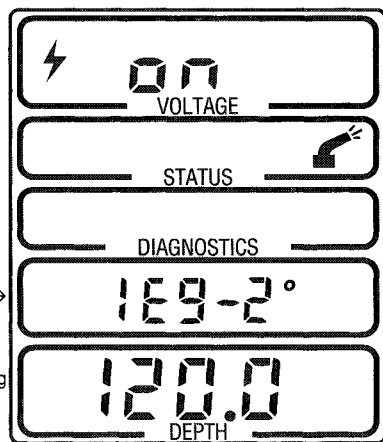

End gun sequence #2 commanded "on" at 120.0 degrees.
 NOTE: Press the SELECT button for at least 2 seconds to delete the "on" and "OFF" angles for sequence #2.

Figure 2.80

Notice that figure 2.80 indicates that the "on" angle for sequence #2 is set at 120 degrees. To delete both the on and off angle for sequence #2, press the SELECT button for at least 2 seconds at this point.

3. Press SELECT for at least 2 seconds to delete the settings for sequence #2.

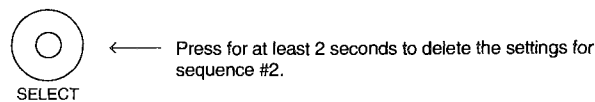

4. Sequence #2 is now empty or blank. The operator can add values for sequence #2, in the future, if needed. Press SETUP to exit or SELECT to enter other values.

REMEMBER: Pressing the SELECT button for at least 2 seconds when either the "on" or "off" angle is displayed, will delete both the on and off angles for that sequence.

OPTIONAL: An end gun or sector control sequence can also be deleted by setting both the on and off angles to the same value. If the "on" angle is set at 25.6 degrees then the "off" angle MUST also be set to 25.6 degrees to delete the sequence.

Changing, Adding and Deleting Programmed Commands in Setup Group 2

Figure 2.81 illustrates Example 2 which was programmed earlier in the section "Setup Group 2". This example will be used to illustrate how changes, additions and deletions can be made to a program like this.

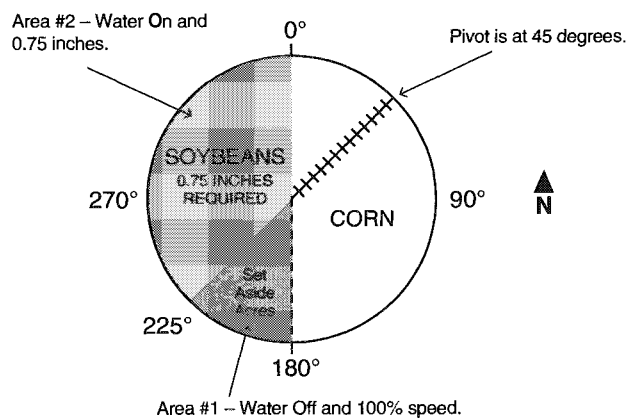

Figure 2.81

- | | |
|-------------------------|--------------------------------|
| Area #1 (Set Aside): | Area #2 (Soybeans): |
| On (Start) Angle = 180° | On (Start) Angle = 225° |
| Off (Stop) Angle = 225° | Off (Stop) Angle = 0° |
| Water Off at 100% speed | Water On and 0.75 inches water |

Making a Change

The operator wants to change the program described in figure 2.81 as follows:

- Change water depth to 0.50 inches for area #2 (soybeans)
- Change the Off (Stop) angle for area #2 to 300 degrees instead of 0.0 degrees.

To make these changes, follow these steps:

1. To change a program, the operator must be in Setup Group 2. Press the Setup button for at least 4 seconds.

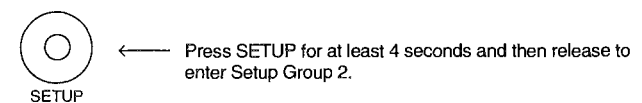

2. Press the SELECT button several times to advance to the "Pr2" screen as illustrated in figure 2.82.

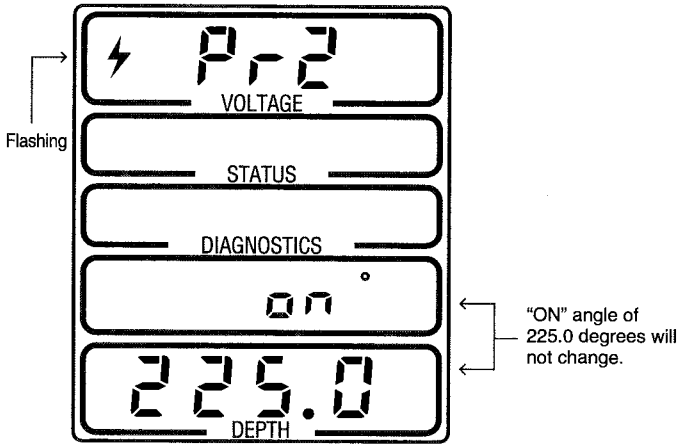

Figure 2.82

3. The On (or Start) angle for area #2 will not change. Press SELECT to advance to the next screen illustrated in figure 2.83. The water depth can now be changed to 0.50 inches.

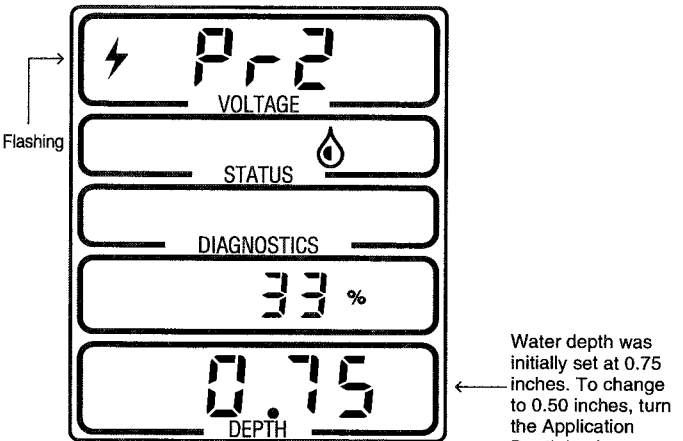
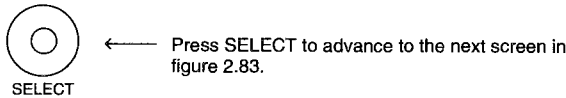
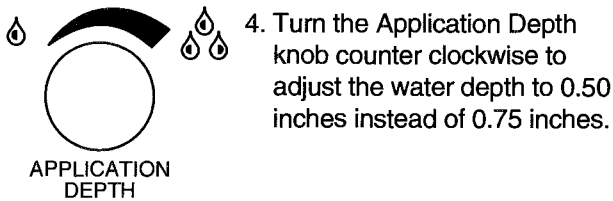

Figure 2.83



This was the only change required for this screen. The next change is to set the OFF (or Stop) angle for area #2 to 300.0 degrees instead of 0.0 degrees.



5. Press SELECT to advance to the next screen displayed in figure 2.84. Change the "OFF" angle for area #2 by turning the knob as explained in step #6.

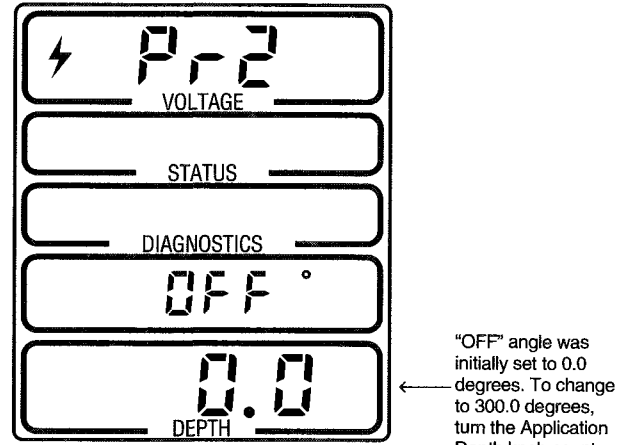
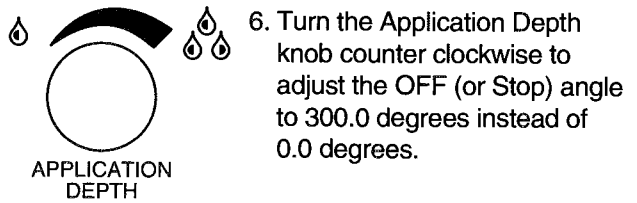

Figure 2.84



7. To exit, press the SETUP button or continue pressing SELECT to review/add/change any other settings.

Adding a Programmed Area

The operator wants to add a third programmed area to the example in figure 2.81:

AREA #3

- On (Start) Angle = 0.0 degrees
- Set Water On applying 1.25 inches
- Off (Stop) Angle = 90.0 degrees

To add a third area to this example, follow these steps:



1. Access SETUP Group 2 by pressing SETUP for at least 4 seconds.

2. Press the SELECT button several times to advance to the “Pr3” screen illustrated in figure 2.85.

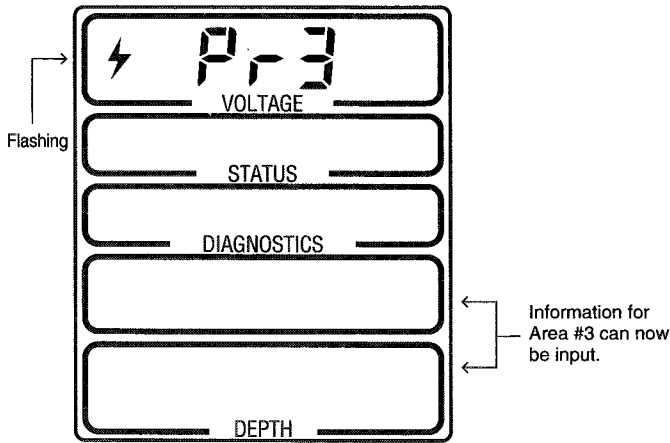

Figure 2.85

3. Input the information for area #3 as described in the previous examples explained in the “Setup Group 2” section. (Procedure is briefly described in the following steps a-g)

- Set “On” angle to 0.0 degrees
- Press Select
- Press Water On
- Set water depth to 1.25 inches
- Press Select
- Set “Off” angle to 90.0 degrees
- Press SETUP or SELECT to exit

After completing these steps, area #3 would be added. Remember – up to a total of 6 different areas can be programmed.

Deleting a Programmed Area

The operator may find it necessary to delete a programmed area. For example, assume that area #2 or “Pr2” of the original example in figure 2.81 needs to be deleted for some reason. Area #2 is defined as follows:

Area #2 or “Pr2”

- On (Start) Angle = 225 degrees
- OFF (Stop) Angle = 0 degrees
- Water On and 0.75 inches of water applied

To delete programmed area #2, follow these steps:



- To delete a programmed area, the operator must be in SETUP Group 2. Press the SETUP button for at least 4 seconds and release.

2. Press the SELECT button to advance to the second programmed area identified as “Pr2” which is displayed in figure 2.86.

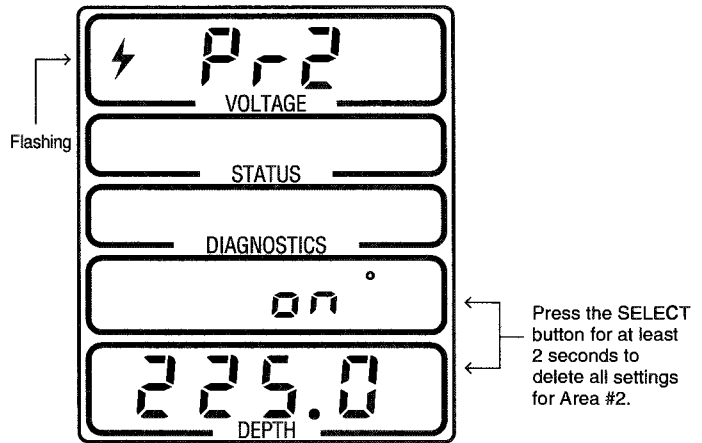

Figure 2.86

Figure 2.86 illustrates that the “on” or start angle for programmed area #2 is set at 225 degrees. To delete both the on (start) and off (stop) angles for area #2, press the SELECT button for at least 2 seconds at this point.

3. Press SELECT for at least 2 seconds to delete the settings for area #2.



Press for at least 2 seconds to delete all settings for Area #2.

4. Area #2 is now empty or blank. The operator can add values for area #2 in the future if needed. Press SETUP to exit or SELECT to enter other values.

REMEMBER: Pressing the SELECT button for at least 2 seconds when either the “on” or “OFF” angle or the screen which appears in between them is displayed, will delete all the settings for the area.

OPTIONAL: A programmed area can also be deleted by setting both the “on” and “OFF” angles to the same values. For example, if the “on” angle is set at 38.9 degrees, then the “OFF” angle MUST also be set to 38.9 degrees to delete the area.

STARTING THE MACHINE WET (WITH WATER)

1. Inspect the wheel tracks to ensure there are no vehicles or other equipment which will obstruct the machine upon start-up or operation.
2. If an engine shutdown circuit is utilized, place the Engine RUN/START switch in the START position.

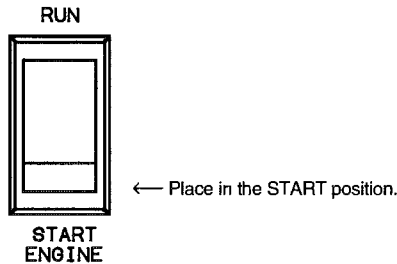

Figure 3.1

3. Partially close the mainline valve to the machine. This will help to prevent “water hammer” if the pump is powered by an electric motor.
4. Start the pump. (The pump may be wired such that when the Forward or Reverse Start Button is pressed, the pump automatically starts. Check with your Valley dealer to determine how your pump has been wired into your control panel.)
5. Slowly introduce more water into the machine by either opening the mainline valve or by increasing the engine speed to ensure the desired operating pressure.
6. Turn the main disconnect switch to the ON position. If the power is supplied by an engine driven generator, adjust the RPM of the generator until the voltage reads 480-505 volts. DO NOT EXCEED 505 VOLTS.

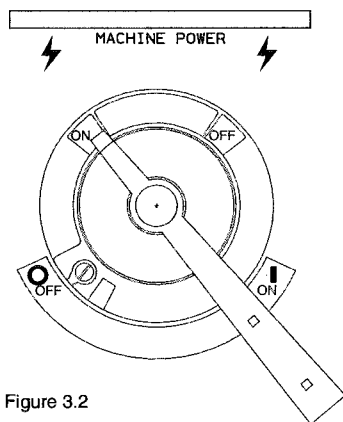

Figure 3.2

7. Select WATER ON.

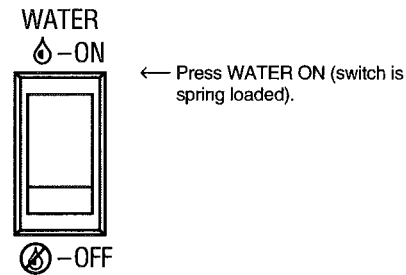

Figure 3.3

8. Press the Forward or Reverse Start button depending on which direction the machine should travel. Remember, forward is clockwise and reverse is counter-clockwise. The button should be pressed for 1-2 seconds and then released. The machine should now start.

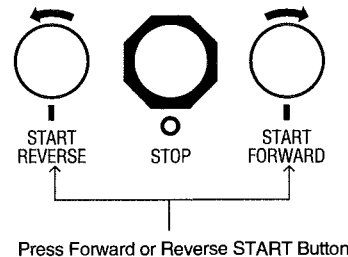

Figure 3.4

NOTE: If the water pressure in the machine was already above the low pressure point, then the machine would start moving at this point. However, if pressing the Forward or Reverse Start button caused the pump to start, then the machine will not start to move at this point because there is not sufficient pressure. It will wait until sufficient water pressure is developed and then it will start moving. The “Waiting” period is denoted by a flashing “water on” symbol as illustrated in figure 3.5.

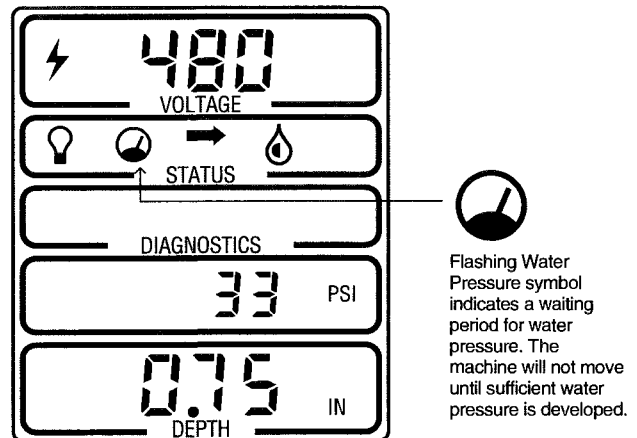

Figure 3.5

9. Place the Engine RUN/START switch in the RUN position.

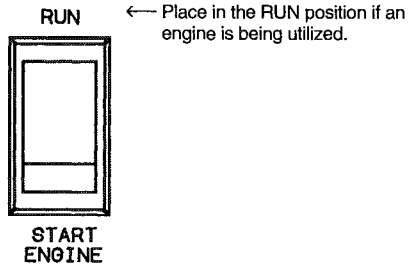

Figure 3.6

10. Select the Water Application amount with the Application Depth knob.

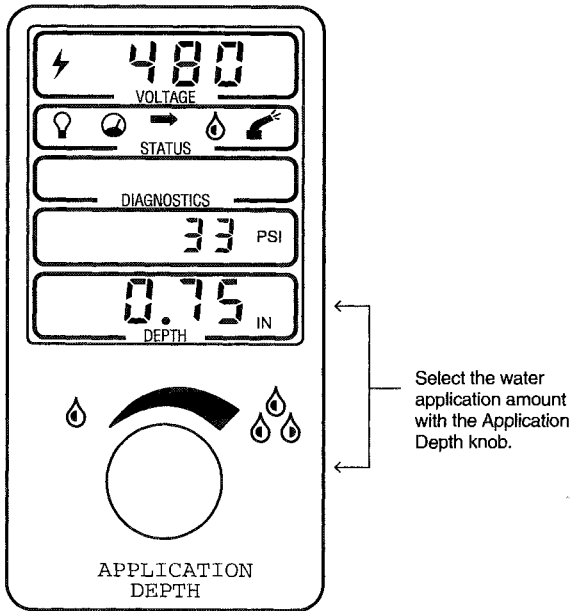

Figure 3.7

11. Place the Stop In Slot switch in the ON or OFF position.

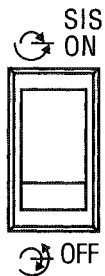

Figure 3.8

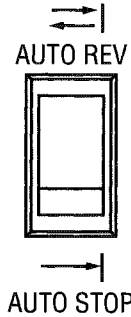

Figure 3.9

12. If the pivot is equipped with the optional drive unit mounted auto reverse/auto stop hardware or it has been programmed to automatically reverse/stop, place the Auto Reverse/Auto Stop switch in the desired position.

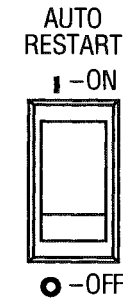

Figure 3.10

13. Select the Auto Restart option to On or OFF.

STARTING THE MACHINE DRY (WITHOUT WATER)

1. Inspect the wheel tracks to ensure there are no vehicles or other equipment which will obstruct the machine upon start-up or operation.

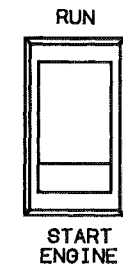

Figure 3.11

2. If an engine shutdown circuit is utilized, place the Engine RUN/START switch in the START position and start the engine.

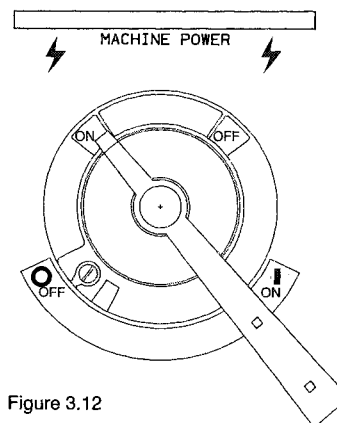

Figure 3.12

3. Turn the main disconnect switch to the ON position. If the power is supplied by an engine driven generator, adjust the RPM of the generator until the voltage reads 480-505 volts. **DO NOT EXCEED 505 VOLTS.**

4. Select WATER OFF.

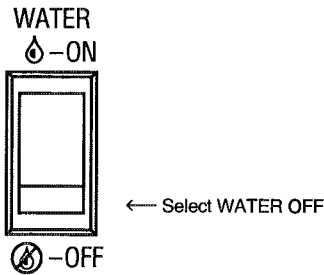
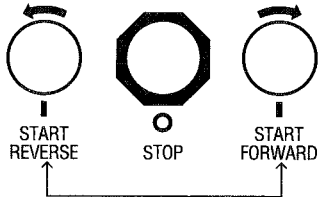

Figure 3.13

5. Press the Forward or Reverse Start button depending on which direction the machine should travel. Remember, forward is clockwise and reverse is counter-clockwise. The button should be pressed for 1-2 seconds and then released. The machine should now start.



Press FORWARD or REVERSE Start Button

Figure 3.14

6. Place the Engine RUN/START switch in the RUN position.

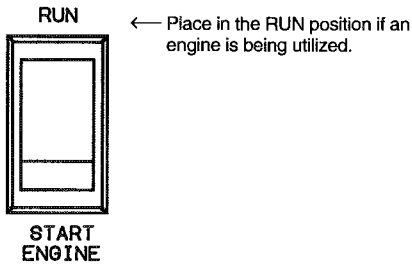

Figure 3.15

7. Select the Percentage Timer Setting with the Application Depth knob. Notice that the water application amount will be 0.00 inches or 0.00 mm.

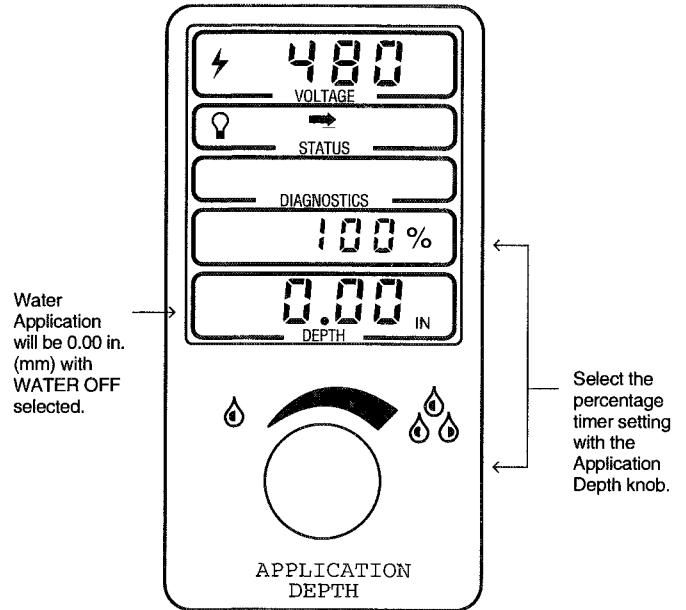

Figure 3.16

8. Place the Stop In Slot switch in the ON or OFF position.

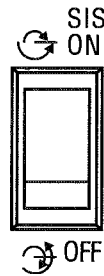

Figure 3.17

9. If the pivot is equipped with the optional drive unit mounted auto reverse/auto stop hardware or it has been programmed to automatically reverse/stop, place the Auto Reverse/Auto Stop switch in the desired position.

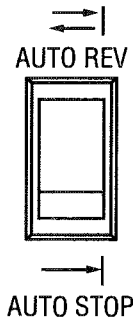
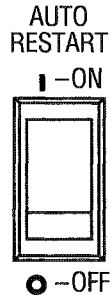

Figure 3.18



10. Select the Auto Restart option to On or OFF.

Figure 3.19

STOPPING THE MACHINE

1. Press the STOP button.

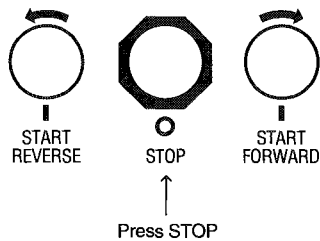

Figure 3.20

2. Turn the Main disconnect switch to the OFF position.

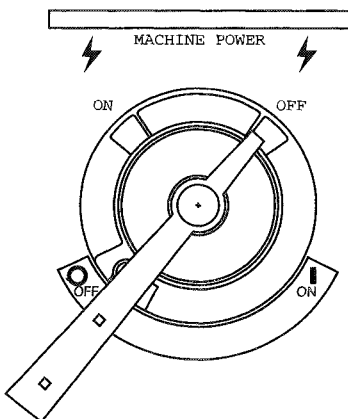

Figure 3.21

3. Turn the pumping unit OFF (if not automatic).

4. If an engine generator set is utilized, place the Engine Run/Start switch to the Start position for the next start-up sequence.

IMPORTANT: Do NOT shut the machine off by slowly idling down the engine-generator set. This practice causes low voltage and will damage components. ALWAYS STOP the irrigation machine prior to shutting down the engine-generator set.

SAFETY OVERRIDE

The Valley Select Control Panel is equipped with a safety override push button switch. Should the machine misalign for some reason and it is necessary to override the safety circuit momentarily to realign the machine, this switch may be used. To use the by-pass function, depress the safety override button in conjunction with the FORWARD OR REVERSE START button.

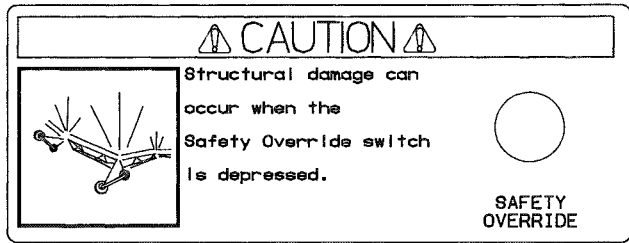

To override safety, press in conjunction with the Forward or Reverse Start Buttons. This practice is NOT recommended.

Figure 3.22

CAUTION: Caution MUST be taken by the operator when this button is depressed as it will by-pass or disable all of the machine's safety circuits. NEVER depress this button for more than 3 to 5 seconds. If the machine is not in full view by the operator, it is not recommended that the Safety Override switch be used.

NEVER depress the override button longer than 3 to 5 seconds. The operator MUST inspect the entire machine between each start attempt. Repeated override start attempts can cause severe structural damage. Call the local Valley dealer should the machine fail to start.

The Valley Select Panel has a standard Diagnostics Screen as illustrated in figure 4.1.

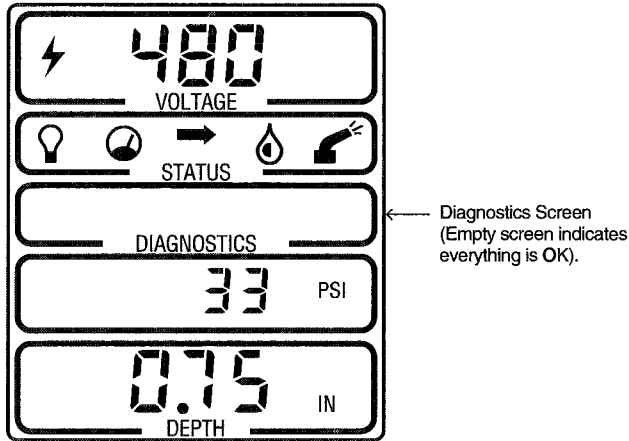

Figure 4.1

The symbols displayed in figure 4.2 represent five different areas which can cause the machine to stop or fail to start.



Figure 4.2

Following is a complete explanation of each symbol:

POWER FAULT



A Power Fault is caused by an interruption of the machine's voltage source or low voltage less than 440 volts.

Check the Voltage Screen to determine if the voltage is below 440 volts. If it is below 440 volts, it will not restart. If the voltage is near 480 volts on the voltage screen, it may have temporarily fallen below 440 volts while the machine was running and therefore caused the machine to shut down.

REMEMBER: The operator has the ability to set a low voltage setting lower than 440 volts, but it is not recommended.

LOW PRESSURE



A Low Pressure Fault indicates that the water pressure fell below the low pressure setting for more than ten seconds.

If the value set for the pressure delay constant is not a sufficient amount of time to build pressure in the machine after it is started, then the machine/pump will be shut down after the pressure delay period expires and the Low Pressure Fault symbol will be displayed. Increase the value of the pressure delay to solve this problem.

COMMAND



Displayed constantly (no flashing) – indicates a commanded shutdown.

Flashing – indicates a control panel problem.

The control panel symbol (not flashing) represents a commanded shut down. This symbol would indicate that the machine was commanded to shut down due to one of the following situations:

1. The STOP button was pressed.
2. The machine was stopped due to the drive unit mounted auto reverse/auto stop option.
3. Pivot was stopped remotely.

IMPORTANT: If the control panel symbol flashes, this indicates a problem in the control panel.

EQUIPMENT SAFETY



An Equipment Safety Fault is caused by a break in the safety return circuit.

STOP IN SLOT

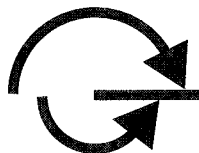

This symbol indicates the machine was shut down due to the stop in slot feature. The Valley Select Panel allows the operator to start the machine at the stop in slot location with the stop in slot switch

in the ON position. The stop in slot is automatically bypassed when starting the machine.

IMPORTANT: Call your local authorized Valley dealer for service on your machine. DO NOT attempt to service your own machine!!!

OTHER ERROR MESSAGES

The Select Panel has another self-diagnostics mode which displays messages in the VOLTAGE screen as illustrated in figure 4.3.

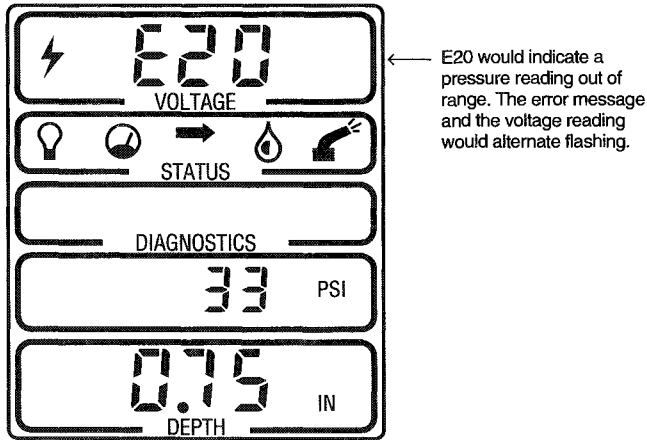

Figure 4.3

Four different error messages may appear in the VOLTAGE screen:

- E20 – pressure out of range (too high)
- E25 – ADC failure
- E33 – relay board communications fault
- E35 – resolver fault

NOTE: Several of these errors would not prevent the machine from running.

If the operator encounters any of these error messages, call your local authorized Valley dealer for service on your machine and indicate which error message is appearing. Do not attempt to service your own machine!

RECORD OF SETUP VALUES 55

TYPICAL END-GUN SETTINGS 56

OVERLAY FOR DETERMINING END-GUN SETTINGS 57

SETUP GROUP #1 VALUES

Stop In Slot _____ degrees

END-GUN SETTINGS

	ON	OFF
1 Eg-1°	_____	_____
1 Eg-2°	_____	_____
1 Eg-3°	_____	_____
1 Eg-4°	_____	_____
1 Eg-5°	_____	_____
1 Eg-6°	_____	_____

SECTOR CONTROL SETTINGS

	ON	OFF
2 Eg-1°	_____	_____
2 Eg-2°	_____	_____
2 Eg-3°	_____	_____
2 Eg-4°	_____	_____
2 Eg-5°	_____	_____
2 Eg-6°	_____	_____

SETUP GROUP #2 VALUES

Area#	Start or ON Angle (degrees)	Depth of Water (inches)	Water ON?	Water OFF?	Stop or OFF Angle (degrees)
1 (Pr1)					
2 (Pr2)					
3 (Pr3)					
4 (Pr4)					
5 (Pr5)					
6 (Pr6)					

SETUP GROUP #3 VALUES

Low Pressure _____ psi (KPa)
 Pressure Delay _____ minutes
 Power Restart Delay _____ minutes
 Percent Timer Cycle _____ seconds

SETUP GROUP #4 VALUES

Minimum Application _____ inches (mm)
 Minimum Hours/Revolution _____ hours
 Low Voltage Setting _____ volts
 Auto Reverse/Stop on or off? _____
 Forward Position _____ degrees
 Reverse Position _____ degrees
 Auto Reverse/Stop Delay _____ minutes
 Direction Offset _____ degree(s)
 Baud Rate _____
 Password _____

TYPICAL END-GUN SETTINGS

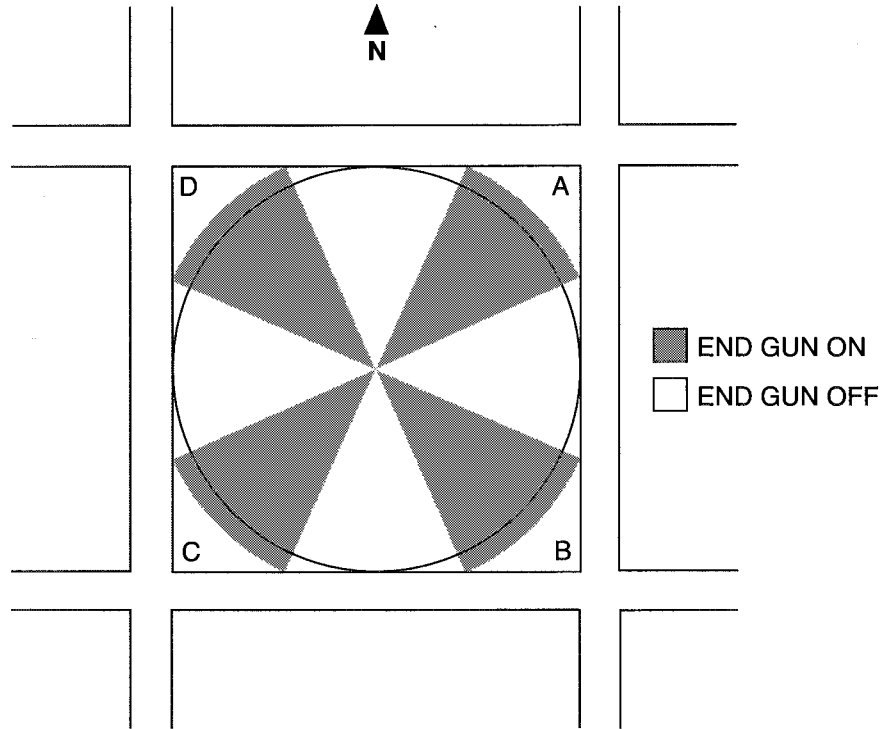

# ACRES	END GUN	SECTOR A		SECTOR B		SECTOR C		SECTOR D	
		ON	OFF	ON	OFF	ON	OFF	ON	OFF
40	Nelson 100	31	59	121	149	211	239	301	329
40	Rainbird 85	27	63	117	153	207	243	297	333
160	Nelson 100	21	69	111	159	201	249	291	339
160	Rainbird 85	18	72	108	162	198	252	288	342
640	Nelson 100	16	74	106	164	196	254	286	344
640	Rainbird 85	13	77	103	167	193	257	283	347

NOTE: These settings are approximate and WILL vary for different fields.

NOTE: The overlay on the following page can also be used to approximate end-gun settings. Insert an aerial photo of the field under the overlay and estimate the on and off values for the end gun.

NOTE: North is generally defined as 0 degrees.

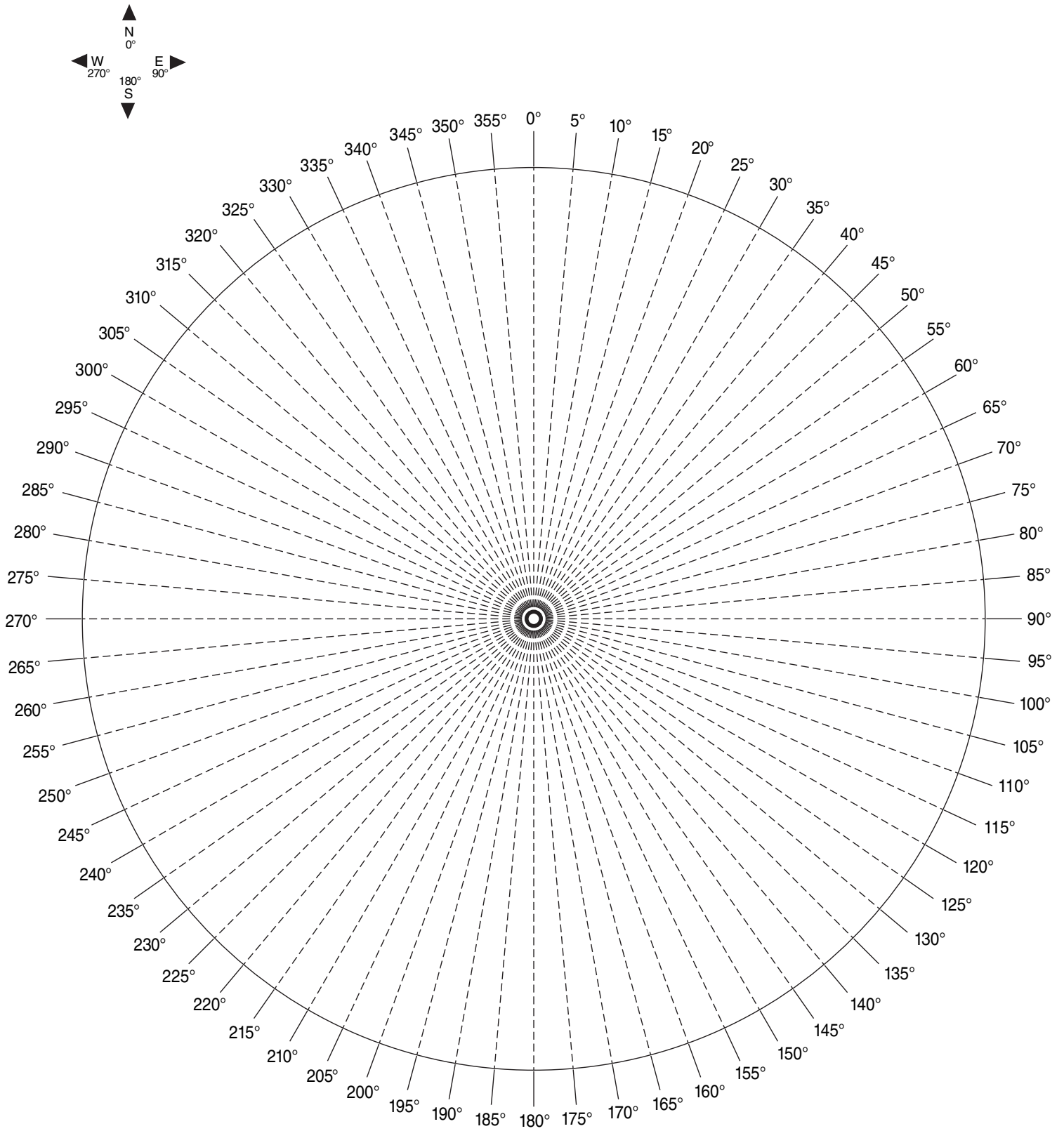

POSITION ACCURACY 59

DETERMINING THE APPROPRIATE DIRECTION OFFSET VALUE 59

-Estimated 59

-Calculated 60

CALCULATING THE DIRECTION OFFSET WORKSHEET 63

POSITION ACCURACY

The Select Panel utilizes a resolver which is installed in the collector ring to determine the position of the pivot in the field as illustrated in figure B.1.

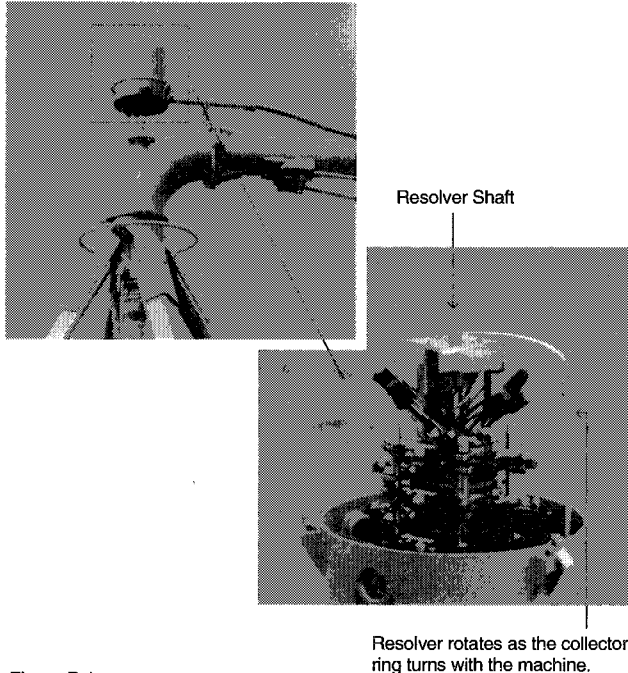

Figure B.1

As the pivot rotates, the collector ring turns which also turns the shaft of the resolver. The resolver sends back two low voltage signals (less than 1 volt) to the Select Panel. These voltage readings change as the resolver shaft turns. The Select Panel then uses these voltage readings to determine field position in degrees. These field position readings are then used to turn the end gun on and off or to stop at the stop in slot position.

Some machines may require some slight adjustments to the pivot position readings. These adjustments may be required for a number of reasons including if the packing material around the J-Pipe is a little too tight or if a pivot flex is used. These situations will be different for every machine, so therefore, you have the ability to make an adjustment based on your individual machine.

Machines which always run in one direction, will generally not need any adjustments. It is when the machine reverses it's direction that "slight adjustments" may need to be made. In this case, the end gun may turn on/off at a location several degrees different than when the machine was running the other direction. The same inaccuracy could hold true for the Stop In Slot setting also. The reason for this is that any "slack" in the mechanical connection to the resolver is taken up during the direction change and can result in slight position inaccuracies in the opposite direction.

It is important to note that accuracy can be expected within a range of plus or minus one degree. One degree on a standard length machine of 1320 feet is equal to 23 feet at the last regular drive unit.

The Direction Offset constant is utilized to adjust or "offset" any inaccuracies in the readings on the screen. If the end gun on/off locations or the stop in slot locations are not repeatable when the direction of the machine is changed, then follow the procedures in the next section to determine the appropriate Direction Offset constant.

DETERMINING THE APPROPRIATE DIRECTION OFFSET CONSTANT

Estimated

The factory preset value for Direction Offset is 1.0 degree. This value is estimated and generally is sufficient in most cases.

However, you may notice that when the direction of the pivot is changed that the end gun turns on or off past or before the normal settings. If the machine runs past the normal end gun on/off settings, the Direction Offset needs to be increased. The Direction Offset must be decreased if the machine is short of the normal end gun on/off settings. This same logic would also hold true for a stop in slot setting as described in the following example:

EXAMPLE

The stop in slot has been set at the pivot road which has been defined as 90.0 degrees. When the machine is running in the forward direction, it always stops near the pivot road. However, when the direction of the machine is changed to reverse, the machine runs past the road about 25 feet as illustrated in figure B.2. On a standard length machine of 1320 feet (typical quarter section machine), one degree on the outer end of the machine is approximately 23 feet. Therefore, the machine “over ran” by about 1 degree. In this case you would add one half of this estimated value to the existing Direction Offset value. If the existing value was 1.0 (factory preset value), then the new value would be approximately $1.0 + 0.5 = 1.5$.

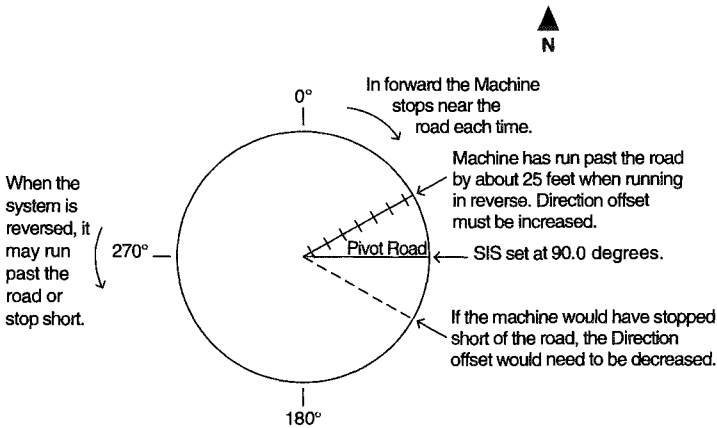

Figure B.2

In the same example, if the pivot would have stopped short by about one degree, then the existing Direction Offset value would have been *decreased* by approximately half a degree.

REMEMBER: The estimated degrees should be divided by two and added or subtracted to the existing Direction Offset value.

RULE OF THUMB: If the pivot is “over running” the locations of end gun operation or stop in slot, then **INCREASE** the Direction Offset. If the pivot is coming up short of these locations, then **DECREASE** the Direction Offset value.

Calculated

A more accurate value for the Direction Offset value can be determined by making a few measurements and actually calculating a value for the direction offset. This procedure will take about 30 minutes to complete. If you choose to do so, then follow this procedure:

STEP 1

Start the machine in the forward or reverse direction and watch the position reading on the display screen. When you see the position change by one or two degrees, then stop the machine. This indicates that all the “mechanical slack” has been taken out of the resolver. (In other words, the resolver is turning as the pivot rotates.)

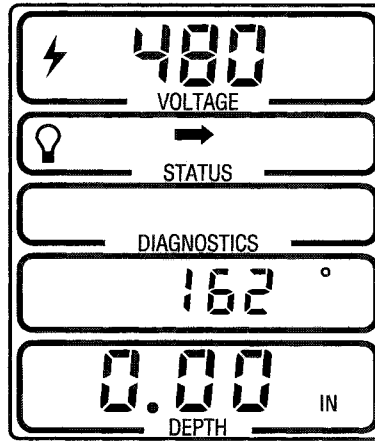

Make sure that the position reading changes one or two degrees. This indicates that the “mechanical slack” has been taken out of the resolver.

Figure B.3

STEP 2

Place a flag at the first regular drive unit (point A) as illustrated in figure B.4 and measure a distance of 15 feet along the FIRST regular drive unit wheel track and place another flag (point B).

NOTE: Measure the distance opposite from the direction the machine ran in step #1.

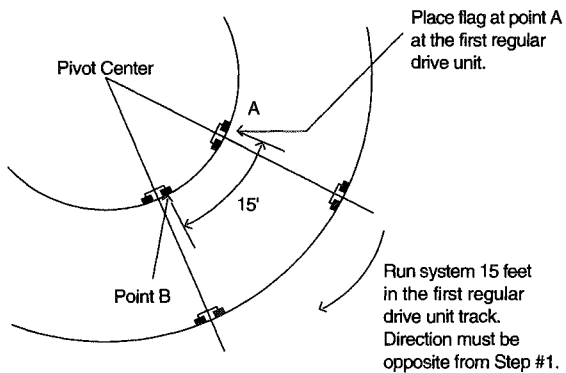
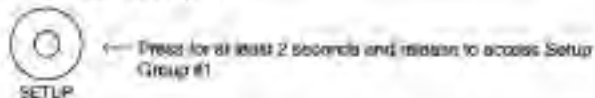

Figure B.4

STEP 3

After placing the flags in step #2, go back to the control panel and determine the position of the machine to the nearest tenth of a degree. To determine the position to the nearest tenth of a degree, you must look at the Current Position value.

- a) Press SETUP for at least 2 seconds to enter SETUP Group #1.



- b) Press the SELECT button once until you see a screen which looks like the one in figure B.5. The Current Position (161.6 degrees in this example) is displayed in the bottom screen. Write this value down as Position 1 and press SETUP to exit.



Figure B.5

STEP 4

Start the pivot in the opposite direction which it ran in step #1 and let it run exactly 15 feet to the flag and STOP the machine. (Remember, the 15 feet is measured at the first regular drive unit track.)

STEP 5

Record the current position again by following the procedure in Step #3. Record this value as Position 2. In this example, that value would be 165.3 degrees as illustrated in figure B.6.

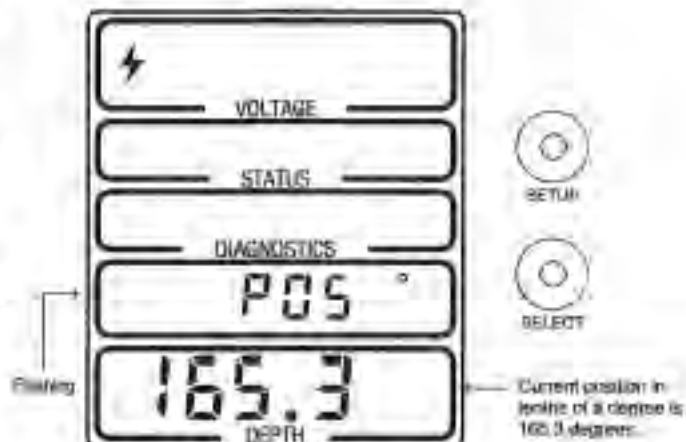

Figure B.6

STEP 6

Determine how many degrees the pivot was supposed to travel in 15 feet. This will be called "Measured Degrees". To do this, you must measure the distance "R" in feet from the center of the pivot to the center-line of the tire on the first regular drive unit as illustrated in figure B.7.

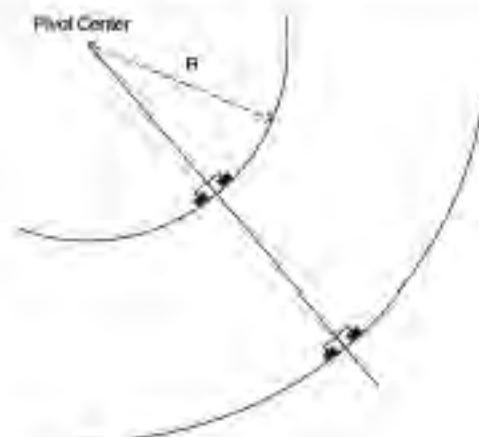

Figure B.7

The formula for Measured degrees is:

$$\text{Measured degrees} = (859.4) / R$$

NOTE: Calculate the "Measured degrees" to the nearest tenth. Remember, the formula above is only good for 15 feet of travel at the first regular drive unit. If you only measure 10 feet worth of travel, this formula can't be used.

EXAMPLE

X was measured as 183.0 feet

$$\text{Measured Degrees} = (859.4) / (183.0) = 4.7 \text{ degrees}$$

STEP 7

Determine the "actual degrees" traveled. This is the difference in readings from steps #3 and #5.

EXAMPLE

Position 1 = 161.6 degrees

Position 2 = 165.3 degrees

If Position 2 is greater than Position 1 (machine ran forward), then:

$$\text{Actual degrees} = \text{Pos2} - \text{Pos1}$$

$$\begin{aligned} \text{Actual degrees} &= 165.3 - 161.6 \\ &= \mathbf{3.7 \text{ degrees}} \end{aligned}$$

If Position 1 is greater than Position 2 (machine ran reverse), then:

$$\text{Actual degrees} = \text{Pos1} - \text{Pos2}$$

STEP 8

Determine the calculated value for the Direction Offset. Determine which Case (I or II) applies to your situation.

CASE I

If the actual degrees is less than the measured value, the direction offset constant must be increased in value:

$$\text{Dir Offset} = \text{Current Dir Offset} + \left[\frac{(\text{Measured Degrees}) - (\text{Actual Degrees})}{2} \right]$$

EXAMPLE

$$\text{Direction Offset} = 1 + \left[\frac{4.7 - 3.7}{2} \right]$$

$$= 1 + \left[\frac{1}{2} \right]$$

$$= 1 + 0.5$$

$$= 1.5$$

CASE II

If the actual degrees is greater than the measured value, the direction offset constant must be decreased in value:

$$\text{Dir Offset} = \text{Current Dir Offset} - \left[\frac{(\text{Actual Degrees}) - (\text{Measured Degrees})}{2} \right]$$

EXAMPLE

$$\text{Direction Offset} = 1 - \left[\frac{5.7 - 4.7}{2} \right]$$

$$= 1 - \left[\frac{1}{2} \right]$$

$$= 1 - 0.5$$

$$= 0.5$$

NOTE: The value for "Current Direction Offset" is the value which is currently entered as the Direction Offset value at the time this procedure is performed. The factory preset value is 1.0 degree.

STEP 9

Enter the "new" calculated value for Direction Offset. See page 40 for instructions on entering the Direction Offset value. The form "Calculating the Direction Offset" on the following page should be used when performing this procedure for quick and accurate results.

CALCULATING THE DIRECTION OFFSET WORKSHEET

STEP 1

Start the pivot in the forward or reverse direction. Make sure the position reading on the display screen has changed by one or two degrees and then STOP the machine.

STEP 2

Measure 15 feet at the first regular drive unit in the running direction opposite to that in step #1.

STEP 3

Record the current position to the nearest tenth of a degree:

Position 1 = _____ degrees

STEP 4

Start the machine, run exactly 15 feet to the flag and stop the machine.

STEP 5

Record the current position again to the nearest tenth of a degree:

Position 2 = _____ degrees

STEP 6

Measure the distance from the center of the riser pipe to the center-line of the tire on the first drive unit. Record this distance in feet as "R".

R = _____ feet

Determine how many degrees the pivot should have traveled. This will be defined as "Measured Degrees".

$$\begin{aligned} \text{Measured Degrees} &= (859.4) / (R) \\ &= (859.4) / (\text{_____}) \\ &= \text{_____} \end{aligned}$$

STEP 7

Determine the "Actual Degrees" traveled.

$$\begin{aligned} \text{Actual Degrees} &= \text{Position 2} - \text{Position 1} \\ &= \text{_____} - \text{_____} \\ &= \text{_____} \end{aligned}$$

Note: If this value is negative, don't worry. Just drop the negative sign and use as a positive value. You are only interested in the value or the difference, not whether or not the machine was traveling forward or reverse.

STEP 8

You are now ready to calculate the new "Direction Offset" value. If the "Actual Degrees" in step #7 is less than the "Measured Degrees" in step #6, then use the formula in CASE I which increases the value for the Direction Offset. If the "Actual Degrees" is greater than the "Measured Degrees", then use the formula in CASE II which decreases the value for the Direction Offset.

CASE I – Actual Degrees Less Than Measured Degrees

$$\text{Dir Offset} = \text{Current Dir. Offset} + \left[\frac{(\text{Measured Degrees}) - (\text{Actual Degrees})}{2} \right]$$

$$\text{Dir Offset} = 1.0 + \left[\frac{(\text{_____}) - (\text{_____})}{2} \right]$$

$$\text{Dir Offset} = 1.0 + \left[\frac{(\text{_____})}{2} \right]$$

$$\text{Dir Offset} = 1.0 + \text{_____}$$

$$\text{Dir Offset} = \text{_____}$$

NOTE: The value used for "Current Dir. Offset" is the value currently entered at the time this procedure is performed. The Factory preset value is 1.0 degree.

CASE II – Actual Degrees Greater Than Measured Degrees

$$\text{Dir Offset} = \text{Current Dir. Offset} - \left[\frac{(\text{Actual Degrees}) - (\text{Measured Degrees})}{2} \right]$$

$$\text{Dir Offset} = 1.0 - \left[\frac{(\text{_____}) - (\text{_____})}{2} \right]$$

$$\text{Dir Offset} = 1.0 - \left[\frac{(\text{_____})}{2} \right]$$

$$\text{Dir Offset} = 1.0 - \text{_____}$$

$$\text{Dir Offset} = \text{_____}$$

NOTE: The value used for "Current Dir. Offset" is the value currently entered at the time this procedure is performed. The factory preset value is 1.0 degree.

STEP 9

Enter the "new" calculated value for Direction Offset. See page 40 for instructions on entering the Direction Offset value.