



**Valley Select2
Control Panel
Owner's Manual**

**For
Software Version 2.00
0998903_B**

Valley Select2 Control Panel

Valley Select2 Control Panel

Table of Contents

Quick Reference Guide	5
EC Declaration of Conformity	7
Electrical Safety Statement	8
About This Manual	8
Ancillary Equipment Warranty	8
Safety	9
Recognize Safety Information.....	9
Safety Messages	9
Information Messages	9
Use of Personal Protective Equipment	10
Conductive Materials and Equipment.....	10
Fall Protection.....	10
Minimum Working Clearance.....	11
Qualified Person	11
Overhead Power Lines	12
Minimal Lockout / Tagout Procedure.....	13
Sequence of Lockout.....	13
Restoring Equipment to Service.....	13
Operate Safely.....	14
Safety Decals	18
Overview	23
Control Panel.....	23
Main Disconnect.....	23
Safety Override Switch.....	23
3 Second Delay Timer	23
Pump Restart Delay	23
Control Panel Display	24
Voltage Display.....	24
Run Status Display.....	24
Diagnostics Display	24
Multiple Information Display	24
Pressure Readout.....	25
Percent Timer Setting.....	25
Hours Per Revolution.....	25
Hours Wet.....	25
Total Hours.....	25
Current Position	25
Flow Meter	25
Water Application Display.....	25
Switch Status Indicators	26
Water Off	26
Water On	26
Auto Restart On.....	26
Auto Restart Off.....	26
Auto Stop	26
Auto Reverse	26
AR/AS Disabled	26
Stop In Slot On	26
Stop In Slot Off	26

Valley Select2 Control Panel

Table of Contents

Overview (Continued)	27
Control Panel Switches	27
Water On/Off Switches	27
Auto Restart On/Off Switches	27
Auto Reverse/Auto Stop Switches	27
Stop-In-Slot On/Off Switches	27
Control Panel Buttons	28
Option Switches	29
Engine Run/Start	29
Auxiliary On/Off	29
Auto/Off/Test	29
Control Panel Setup	31
Minimum Control Panel Setup	33
Setup GPS Using Manual Method (Machines With GPS)	35
Setup GPS Position Loss Shutdown	36
Test and Adjust GPS Position	37
Voltage	38
Low Voltage	38
Estimated Drive Unit Speed Table	38
GPS Angular Conversion Table	39
Angular Degree Examples	39
Operation	40
Run The Machine Wet (With Water)	40
Run The Machine Dry (Without Water)	40
Stopping The Machine	41
Emergency Stopping	41
Stopping Under Normal Conditions	41
Diagnostics	42
Diagnostics Screen	42
Power Fault	42
Low Pressure	42
Equipment Safety	42
Command	42
Stop In Slot	42
Error Codes	43
Viewing or Clearing An Error Code	43
Troubleshooting	44
System Faults	45
Error Codes	46
Error Code Descriptions	46
Troubleshooting List	49
Hard Reset	51
Executing A Hard Reset	51
Contrast Control	51
Advanced Feature Guide	52
Appendix	54
Setup Record Forms	54
Program Design Forms	56

Valley Select2 Control Panel

Quick Reference Guide

TO RUN THE MACHINE:

Refer to the Overview section of the Owner's Manual, Part Number 0998903 (English), for a detailed explanation.

1. Place the Engine Run/Start switch in the START position (if engine is being utilized).
2. Start the pump if it is not wired to start automatically and pressurize the machine slowly. (Delete this step if running without water.)
3. Press WATER ON or WATER OFF (if running without water).
4. Press the FORWARD or REVERSE Start button.

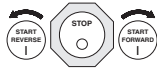

5. Place the Engine Run/Start switch in the RUN position (if engine is being utilized).
6. Select the Water Application amount with the Application Depth buttons. If Water Off has been selected, set the percentage timer setting with the Application Depth buttons.
7. Select the desired settings for Auto Restart, Auto Reverse/Auto Stop, and Stop-In-Slot.
8. To Stop, press the STOP button.

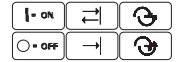

DISPLAY SCREEN ICONS AND SYMBOLS:

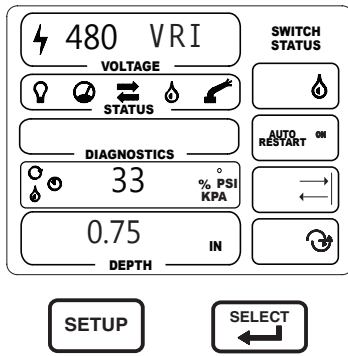

Press "i" button each time to display one of the following pieces of information:

- PSI or KPa PRESSURE
- HOURS WET
- % PERCENT TIMER
- TOTAL HOURS
- HOURS PER REVOLUTION
- MACHINE POSITION

DISPLAY SCREEN DESCRIPTION

Incoming voltage is 480 volts. VRI is displayed when water is ON and VRI-Speed program is enabled or running.

- Machine is running.
- Water pressure is sufficient (above the low pressure setting). If flashing, the machine is waiting for water pressure to start.
- Machine is running in the forward direction.
- Machine is running in the reverse direction.
- Water On is selected.
- End gun is turned on.

Diagnostics display is blank indicating everything is OK.

Water pressure in the machine is 33 psi.

Machine is applying 0.75 inches of water.

The switch status displays the water is On, Auto Restart and Auto Reverse is On, and SIS is Off.

- FLASHING Water Pressure symbol** indicates a waiting period for water pressure. The machine will not move until sufficient water pressure is developed.
- DELAY** **FLASHING** indicates the machine will restart after the delay period has timed out. The delay period for power auto restart can be set from 0-5000 seconds.
- FLASHING Water On symbol** indicates the machine is watering in place (not moving) at the auto reverse or auto stop points.
- PrgOFF** **FLASHING** indicates all programmed areas have been turned off. Access SETUP Group 2 to enable the program feature again.

DIAGNOSTICS SCREEN

The cause of a shutdown will be indicated by one of these symbols in the DIAGNOSTICS screen. A blank screen indicates everything is operating correctly - NO PROBLEMS. Refer to the Diagnostics section of the Owner's Manual, Part Number 0997443 (English), for a detailed explanation of the diagnostics symbols.



- Power Fault** - Power failure or low voltage.
- Low Pressure Fault** - Pressure fell below low pressure set point.
- and **F Pos or R Pos Fault** - Machine has gone out of bounds or the Forward or Reverse Position is being used, the resolver has problems or is disconnected, and AR/AS is enabled.
- and **GPS LOCK Fault** - Machine shutdown due to GPS signal loss for the user specified time. GPS Loss Shutdown must be set to Standard or DGPS for this fault to occur.
- and and **GPS COM Fault** - Machine shutdown due to no GPS communications for the user specified time. GPS Loss Shutdown must be set to Standard or DGPS for this fault to occur.
- Command Fault** - Machine has been commanded off. (Flashes if there is a control panel problem, both run lines are hot, relay com fault or BBRAM Fault).
- Safety Fault** - Machine safety circuit is incomplete.
- SIS Fault** - Stop-In-Slot position shut down.

QUICK REFERENCE GUIDE

Valley Select2 Control Panel

Quick Reference Guide

SETUP

The SETUP button is used to enter values which are unique to the machine and must be entered when the panel is first installed. Some of the values may need to be changed after the initial setting. Flashing descriptions of the value displayed indicating which value you are reviewing or editing.

QUICK REFERENCE GUIDE

SETUP Press and hold the SETUP button until the desired Setup Group is displayed or press the SETUP button the same number of times as the Setup Group number. Pressing the SETUP button while in any Setup Group will advance the operator to the next setup group. Any changes made will be saved.

SELECT Pressing the SELECT button will advance the operator to the next value in the Setup Group. Any changes made will be saved.

+ OR **-** The APPLICATION DEPTH buttons are used to set values in the Setup Groups. Holding either of the buttons longer will advance the values at a faster rate.

i Pressing the INFORMATION button while in any of the Setup Groups will return the operator to the main screen and normal operating mode. Any changes made will be saved.

SETUP GROUPS

Refer to the SETUP SECTION in the Select2 Control Panel Advanced Features Manual, Part Number 0997503 (English) for a detailed explanation of the Setup Groups.

Press and hold the SETUP button until the desired Setup Group is displayed or press the SETUP button the same number of times as the Setup Group number.

SETUP GROUP 1 - OPTIONS

Stop In Slot VRI-Speed
Forward Position End Gun
Reverse Position Wide Boundary

SETUP GROUP 2 - PROGRAMS

Program On/Off
Sector Programs (1-9)

SETUP GROUP 3 - TIMERS

Startup Pressure Delay Auto Reverse/Stop Delay Period
Operating Pressure Delay Percent Timer Cycle
Power / Pressure Restart Delay

SETUP GROUP 4 - CONSTANTS

Minimum Application Direct Offset
Low Hours Per Revolution Engine Control Pump/Engine/Alt Engine
Low Pressure Auto Restart Both/Pressure/Power
Voltage Calibration Flow Meter Off / On
Low Voltage Gallons (Liters) Per Pulse
Auto Reverse/Stop Enable English or Metric Units
Current Position Language

SETUP GROUP 5 - COMMUNICATIONS

Baud 9-Pin Protocol 25-Pin
Protocol 9-Pin RTU ID
Baud 25-Pin

SETUP GROUP 6 - ERROR CODES

Error Codes 1-14, 18-20, 23, and 25

SETUP GROUP 7 - TIME/DATE

Hours Month
Minutes Day
Year

SETUP GROUP 8 - GPS

Current Latitude Pivot Speed
Current Longitude GPS Distance
Satellite Count, Lock Length (-)
Pivot Point Review, Set or Edit Length (+)
Pivot Point Latitude Shutdown System Timer
Pivot Point Longitude Disable End guns Timer
Fallback Position GPS Loss Shutdown
Pivot Length

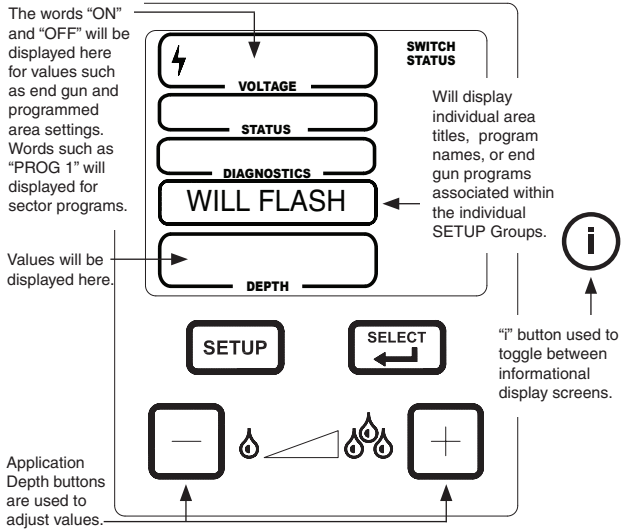

SETUP GROUP 6 - ERROR CODES & DESCRIPTIONS

ERROR	DESCRIPTION
E01	BBRAM - CHECKSUM FAILED AT POWER UP
E02	EEPROM - CHECKSUM FAILED AT POWER UP.
E03	UNIT RESETS - THIS IS LOGGED WHEN THE SOFTWARE RESETS.
E04	POWER DROP - POWER DROPPED BELOW LOW VOLTAGE LIMIT.
E05	SYSTEM SAFETY - POSSIBLE TOWER MISALIGNMENT, DRIVE UNIT MAY BE STUCK.
E06	PUMP SAFETY - PRESSURE TOO LOW AFTER PRESSURE DELAY.
E07	PRESSURE SENSOR - OUT OF RANGE HIGH, CHECK CONNECTION.
E08	PRESSURE SENSOR - OUT OF RANGE LOW, CHECK CONNECTION.
E09	PRESSURE SENSOR - PRESSURE HIGH WITH PUMP OFF, CHECK CONNECTION.
E10	PRESSURE SENSOR - MECHANICAL SWITCH COULD BE STUCK.
E11	RESOLVER - ANGLE JUMPING AROUND, LUBE J PIPE.
E12	E12 RESOLVER - OUT OF RANGE HIGH, CHECK FOR LOOSE OR SHORTED WIRES.
E13	KEYPAD - POSSIBLE KEY STUCK, CHECK KEYPAD CONNECTION.
E14	FWD/REV SENSE - POSSIBLE SHORT, CHECK WIRING.
E18	GPS COMMUNICATION ERROR, CHECK GPS COMMUNICATION AND POWER.
E19	GPS SIGNAL LOSS, CHECK FOR CLEAR PATH ABOVE ANTENNA. POSITION WILL FLASH WHEN ERROR OCCURS.
E20	DGPS SIGNAL LOSS, CHECK FOR CLEAR PATH ABOVE ANTENNA.
E23	PLC COMMUNICATIONS ERROR. (GPS v2 Only)
E25	GPS COORDINATES OUT OF RANGE, CHECK DISTANCE TO GPS OR FOR CROSSTALK.

Valley Select2 Control Panel

EC Declaration of Conformity



We: **Valmont Industries, Inc.**
28800 Ida Street
Valley, NE 68064
+1 402.359.6312
+1 402.359.6143 (Facsimile)

Serial Number:

Purchase Order:

declare under our sole responsibility that the product,

Crop Irrigation System

to which this documentation relates, is in conformity with the following documents:

Machinery Directive 2006/42/EC
Low Voltage Directive 2006/95/EC
Electromagnetic Compatibility Directive 2004/108/EC

The above-referenced equipment is in conformity with all safety-related clauses (Not all clauses reflecting commercial preference are met) of the following documents:

EN 60204-1:2006 Safety of Machinery – Electrical Equipment of Machines
EN 12100:2010 Safety of Machinery
EN 909:1998+A1 Irrigation Machines

Statement regarding **Pressure Equipment Directive 97/23/EC:**

The Crop Irrigation System is excluded from the scope of the Pressure Equipment Directive, by the language of Article 1, Sections 3.2, 3.6 & 3.10. This equipment is classified less than Category 1.

Statement regarding **RoHS Directive 2011/65/EC:**

The Crop Irrigation System is excluded from the scope of the RoHS Directive, by the language of Article 2, Section 4(e), being a "Large Scale Fixed Installation."

Person Authorized to Compile the Technical File in Europe:
Relevant information will be transmitted via e-mail
in response to a reasoned request by national authorities

Philipp Schmidt-Holzmann
Valmont S.A.U.
28840 Mejorada del Campo
Madrid, ES 28840
+34 91 679 4300

Ron Pollak
Senior Electrical Engineer
Valmont Industries, Inc.

Date of Issue: March 9, 2015
Place of Issue: Valley, NE 68064

Valley Select2 Control Panel

Electrical Safety Statement

Installation Of The Valley Electric Irrigation Machine - European Union Only

Valmont Industries Inc. does not install a differential (ground fault) circuit breaker in the control panel of the Valley electric irrigation machine because the standards of protection vary according to country of destination. The distributor must provide and install a differential (ground fault) circuit breaker that meets the standards of the country where the Valley irrigation machine is installed.

In the European Union, differential circuit breaker protection is fixed at a maximum of 24 volts.

Good grounding of the Valley irrigation machine is required.

- If resistance to ground is lower than 80 ohms, a differential (ground fault) circuit breaker of 300 mA will meet requirements.
- If resistance to ground is between 80 and 800 ohms, a differential (ground fault) circuit breaker of 30 mA will meet requirements.

The power supply installation and inspection of equipment protection components or machines are the responsibility of the installer. Valmont Industries Inc. is not responsible for the failure of equipment protection components or machines not of their manufacture.

Valley pivot irrigation machines receiving power from a generator must have a cable connected from the irrigation machine structure to a ground rod and another cable from the irrigation machine structure to the ground terminal on generator in order for the differential (ground fault) circuit breaker to work.

- The resistance between the irrigation machine and the generator must be substantially below 80 ohms.

About This Manual

Information contained in this manual applies to all Valley Select2 Control Panels with software version 2.00.

You, as the owner/operator, should familiarize yourself with the capabilities of the system in order to obtain optimum system performance. It should be remembered that the sprinkler will perform according to your knowledge of the equipment, soil and water relationships and equipment application concepts.

Specifications, descriptions and illustrative material contained herein were as accurate as known at the time this publication was approved for printing.

Valmont Industries Inc., reserves the right to change specification or design without incurring obligation. Specifications are applicable to machines sold in the United States and may vary outside the United States.

Additional information is contained within THE Valley Select2 Control Panel Advanced Features Manual, Part Number 0998905 (English).

Ancillary Equipment Warranty

The owner is responsible for warranty registration of all ancillary equipment such as engines, pumps, and generators with its respective manufacturer.

Recognize Safety Information

This irrigation equipment can be powered by high voltage, which can be extremely dangerous if used improperly. For maximum safety and optimum performance of the machine, all owner/operators and maintenance personnel must read and understand the owner/operator manual(s), all safety messages in this manual and safety signs/decals on the machine before operating this equipment.

Anyone assembling, operating, servicing or maintaining this machine must read and understand all operation, maintenance, troubleshooting, testing, installation, assembly instructions and all safety messages in this manual before operating the machine or beginning any maintenance, troubleshooting, testing, installation or assembly of components.

These instructions alert you to certain things you should do carefully; if you don't, you could hurt yourself or others, hurt the next person who operates the equipment, or damage the equipment.

Safety Messages

Safety messages in this manual are preceded by the hazard symbol and one of three words: DANGER, WARNING or CAUTION. These messages alert you to potential hazards that could hurt you or others and or cause property damage.



This HAZARD SYMBOL is used to alert you to information about unsafe actions or situations, and may be followed by the word DANGER, WARNING or CAUTION.

DANGER

The HAZARD SYMBOL used with the word DANGER describes immediate hazards that can result in severe personal injury or death.

WARNING

The HAZARD SYMBOL used with the word WARNING describes unsafe actions or situations that can result in severe injury, death and/or major equipment or property damage.

CAUTION

The HAZARD SYMBOL used with the word CAUTION describes unsafe actions or situations that can result in injury, and/or minor equipment or property damage.

Information Messages

Important information messages in this manual are preceded by the word NOTE.

NOTE

The word NOTE is used to alert you to information that describes procedures or tips to help you install, operate or maintain your equipment properly.

Valley Select2 Control Panel

Safety

Use of Personal Protective Equipment

- People working in areas where there are potential electrical hazards must use, personal protective equipment that is appropriate for the specific parts of the body to be protected and for the work to be performed. Refer to U.S. Occupational Safety & Health Administration (OSHA) Regulations (Standards - 29 CFR) Safeguards for personnel protection. - 1910.335, or applicable national, state or local regulations, for additional information.
- Personal protective equipment must be maintained in a safe, reliable condition and periodically inspected or tested.
- Protective shields, protective barriers, or insulating materials must be used to protect each person from shock, burns, or other electrically-related injuries while that person is working near exposed energized parts which might be accidentally contacted or where dangerous electric heating or arcing might occur. When normally enclosed live parts are exposed for maintenance or repair, they must be guarded to protect unqualified persons from contact with the live parts.
- Safety signs and tags. Safety signs, safety symbols, or accident prevention tags must be used where necessary to warn people about electrical hazards which may endanger them.

Conductive Materials and Equipment

Materials and equipment that can conduct electricity must be handled in a way that will prevent them from contacting energized power lines, exposed conductors or circuit parts.

- When handling long conductive objects (such as but not limited to truss rods, pipes, angles and ladders) in areas with energized power lines, exposed conductors or circuit parts, work practices (such as the use of insulation, guarding, and material handling techniques) must be used to minimize the hazard.
- Portable ladders must have non-conductive side rails.
- Do not wear conductive articles of jewelry and clothing (such as but not limited to watch bands, bracelets, rings, key chains, necklaces, metalized aprons, cloth with conductive thread, or metal headgear) that could come in contact with energized power lines, exposed conductors or circuit parts.

Fall Protection

Identify potential fall hazards and determine if fall protection equipment is appropriate for the task, before beginning the work. Pay attention to hazards associated with routine and non-routine tasks. Inspect fall protection equipment (harnesses, lanyards) and devices (guardrails, tie-off points) before each use. Use fall protection equipment if required for the job. Be sure the fall protection equipment is right for the task, fits properly, and is in good condition. Refer to U.S. Occupational Safety & Health Administration (OSHA) Regulations Standards - 29 CFR 1926.500, 1926.501 and 1926.502, or applicable national, state or local regulations for more information.

- When using scaffolds, make sure there is proper access, full planking, stable footing, and guard railing.
- When using a boom lift, keep feet firmly on the platform of a boom lift, use fall protection equipment tied-off at all times to the guardrail or tie-off point.
- When using a ladder, make sure the ladder is non-conductive and the correct size for the task. Read the ladder user instructions and be sure the ladder is in good condition. Make sure ladder is set on stable footing and at the correct angle.

Minimum Working Clearance

To reduce the risk of injury, all persons require adequate working clearance around the electrical panel or other electrical equipment. The table below identifies the minimum working clearance needed. Refer to U.S. Occupational Safety & Health Administration (OSHA) Regulations (Standards - 29 CFR) Safeguards for personnel protection. -1910.303(g)(1)(i), or any other applicable national, state or local regulations, for additional information.

MINIMUM WORKING CLEARANCE 0-600 VOLTS				
WIDTH OF WORKING CLEARANCE AREA	HEIGHT OF WORKING CLEARANCE AREA	*MINIMUM WORKING CLEARANCE IN FRONT OF ELECTRICAL PANEL/EQUIPMENT		
		EXPOSED LIVE PARTS ON ONE SIDE OF WORK SPACE AND NO LIVE GROUNDED PARTS ON THE OTHER SIDE.	EXPOSED LIVE PARTS ON ONE SIDE OF WORK SPACE AND LIVE GROUNDED PARTS ON THE OTHER SIDE.	EXPOSED LIVE PARTS ON ONE SIDE OF WORK SPACE AND EXPOSED LIVE PARTS ON THE OTHER SIDE.
30in.(760mm) MINIMUM OR WIDTH OF ENCLOSURE, WHICH EVER IS GREATER	78in.(1980mm) MINIMUM OR HEIGHT OF ENCLOSURE, WHICH EVER IS GREATER	36in.(915mm) MINIMUM	42in.(1065mm) MINIMUM	48in.(1220mm) MINIMUM

*Concrete, brick or tile walls shall be considered as grounded.

Qualified Person

A Qualified Person is one who, by possession of a recognized degree, certificate, or professional standing, or who by extensive knowledge, training, and experience, has successfully demonstrated his/her ability to solve or resolve problems related to the subject matter, the work, or the project.

Only qualified persons may work on electric circuit parts or equipment that have not been de-energized.

Refer to U.S. Occupational Safety & Health Administration (OSHA) Regulations Standards - 29 CFR 1926.32(m) and 1910.333, or applicable national, state or local regulations for additional information.

Valley Select2 Control Panel

Safety

Overhead Power Lines

Assembling, towing or transporting irrigation machine components such as but not limited to the pivot point, linear cart, span/drive unit assemblies, overhangs and/or corner assemblies underneath or near power lines is extremely dangerous because of the risk of electrocution.

Operating equipment that elevates irrigation machine components, such as but not limited to an aerial lift or crane, near power lines is extremely dangerous because of the risk of electrocution. Only qualified personnel should operate this type of equipment. Before operating the equipment, qualified personnel must read the equipment manufacturers' operating and safety instructions.

Refer to U.S. Occupational Safety & Health Administration (OSHA) Regulations (Standards - 29 CFR) Cranes and derricks. - 1926.550, or any other applicable national, state or local regulations for additional information.

- Always presume that any overhead power line is an energized line unless and until the person(s) owning the line and/or the electrical utility authorities indicate that it is not an energized line and it has been visibly grounded.
- Before operating any equipment near any power line make sure the line has been de-energized and visibly grounded at the point of work.
- Electrocution can occur without touching an electrical power line. Electricity, depending on the magnitude, can jump or become induced into equipment or conductive materials that come in close proximity to, but do not touch a power line. High wind, lightning, wet ground and other environmental conditions will increase the possibility of electrocution and require additional consideration.
- Transmitter towers can induce the equipment or materials being handled with an electrical charge. Before working or operating equipment near transmitter towers, make sure the transmitter is de-energized.
- Select the location where the span/drive unit will be assembled to ensure that neither the irrigation machine, or the equipment used during the assembly process, will violate the minimum clearance guidelines.
- Never operate equipment or allow the load, ropes or tag lines within 10 ft (3.05 m) of any power line rated 50 kV or lower whether it is energized or not. For lines rated over 50 kV, the minimum clearance shall be 10 ft (3.05 m) plus 0.4 inch (1.1 cm) for each kV over 50 kVs.
- Never assemble, tow, transport or allow irrigation machine components underneath or within 10 ft (3.05 m) of any power line rated 50 kV or lower whether it is energized or not. For lines rated over 50 kV, the minimum clearance shall be 10 ft (3.05 m) plus 0.4 inch (1.1 cm) for each kV over 50 kVs. Overhang support angles, cables and spinner drive components regularly extend 10 ft to 12 ft (3.1 m to 3.7 m) above the irrigation pipeline (span).
- Use barricades to identify areas where interference with overhead power lines could occur. Keep the assembly, towing or transporting of irrigation machine components and the operation of equipment including load, ropes or tag lines away from any power line, in the distances described above, whether the line is energized or not.
- Always designate a person to observe clearance between the power line and all equipment being operated or moved in order to give timely warning for all operations to STOP if the minimum clearance is violated.

Minimal Lockout / Tagout Procedure

The following procedure establishes the minimum requirements for the lockout of energy isolating devices whenever maintenance or servicing is done on machines or equipment. It is used to ensure that the machine or equipment is stopped, isolated from all potentially hazardous energy sources and locked out before personnel perform any servicing or maintenance where the unexpectedly energized or start-up of the machine or equipment or release of stored energy could cause injury. All personnel, upon observing a machine or piece of equipment which is locked out to perform servicing or maintenance shall not attempt to start, energize, or use that machine or equipment.

When the energy isolating devices are not lockable, tagout should be used and affected personnel must wear full personal protection.

Refer to U.S. Occupational Safety & Health Administration (OSHA) Regulations (Standards - 29 CFR) Typical minimal lockout procedures - 1910.147 App A, or applicable national, state or local regulations, for additional information.

Sequence of Lockout

1. Notify all affected personnel that servicing or maintenance is required on a machine or equipment and that the machine or equipment must be shut down and locked out to perform the servicing or maintenance.
2. The authorized personnel shall identify the type and magnitude of the energy that the machine or equipment utilizes, shall understand the hazards of the energy, and shall know the methods to control the energy.
3. If the machine or equipment is operating, shut it down by the normal stopping procedure (depress the stop button, open switch, close valve, etc.).
4. De-activate the energy isolating device(s) so that the machine or equipment is isolated from the energy source(s).
5. Lock out the energy isolating device(s) with assigned individual lock(s).
6. Stored or residual energy (such as that in capacitors, springs, elevated machine members, rotating fly-wheels, hydraulic systems, and air, gas, steam, or water pressure, etc.) must be dissipated or restrained by methods such as grounding, repositioning, blocking, bleeding down, etc.
7. Ensure that the equipment is disconnected from the energy source(s) by first checking that no personnel are exposed, then verify the isolation of the equipment by operating the push button or other normal operating control(s) or by testing to make certain the equipment will not operate. CAUTION: Return operating control(s) to neutral or "off" position after verifying the isolation of the equipment.
8. The machine or equipment is now locked out.

DANGER

•WHEN PERSONNEL WILL BE EXPOSED TO CIRCUIT ELEMENTS AND ELECTRICAL PARTS, A QUALIFIED PERSON MUST USE TEST EQUIPMENT TO VERIFY THAT THE CIRCUIT ELEMENTS AND EQUIPMENT PARTS OF THE EQUIPMENT ARE DE-ENERGIZED.

Restoring Equipment to Service

When the servicing or maintenance is completed and the machine or equipment is ready to return to normal operating condition, the following steps shall be taken:

1. Check the machine or equipment and the immediate area around the machine to ensure that non-essential items are removed and that the machine or equipment components are operationally intact.
2. Check the work area to ensure that all personnel are safely positioned or removed from the area.
3. Verify that the controls are in neutral.
4. Remove the lockout devices and re-energize the machine or equipment.
5. Notify affected personnel that the servicing or maintenance is completed and the machine or equipment is ready to be used.

Valley Select2 Control Panel

Safety

Operate Safely

Valley Irrigation machines are designed with safety in mind. However, if this machine is operated incorrectly, it may pose a safety threat to the operator. A good safety program is much like a chain, it is only as strong as its weakest link. The manufacturer, dealer, and operator must maintain and improve all safety programs. Following is a list of safety operating tips which you and all other persons servicing or operating the machine must read and understand:

CAUTION

- DO NOT OPERATE THIS MACHINE WITHOUT FIRST READING THE OWNER'S MANUALS FOR THE MACHINE.
- READ ALL SAFETY MESSAGES IN THIS MANUAL AND SAFETY SIGNS ON THE MACHINE.
- DO NOT LET ANYONE OPERATE THIS MACHINE WITHOUT PROPER INSTRUCTIONS.
- UNAUTHORIZED MODIFICATIONS MAY IMPAIR THE FUNCTION AND/OR SAFETY OF THE MACHINE.
- IF YOU DO NOT UNDERSTAND ANY PART OF THIS MANUAL, CONTACT YOUR VALLEY DEALER.

EMPLOYEE INSTRUCTION ON SAFETY

It is very important to instruct your employees on the safe use of this equipment at the time of their initial assignment to operate it. DO NOT let anyone operate this equipment without proper instructions.

Safety training should be presented annually and the service manager should ensure employees fully understand the safety messages and what to do in case of emergencies.

EMERGENCY STOPPING

The machine can be stopped at any time at any tower by turning the disconnect switch, located underneath the tower box, to the OFF position. Refer to Figure 14-1.

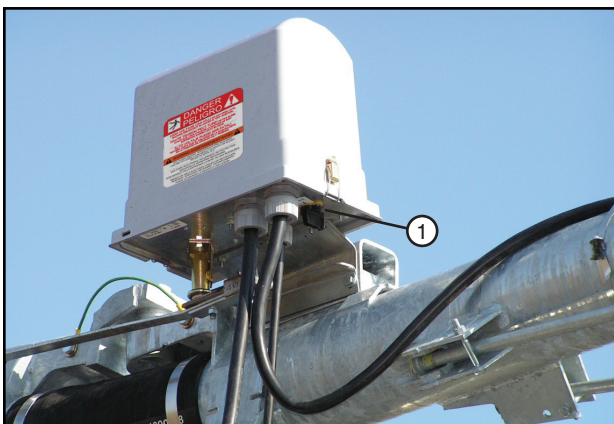

Figure 14-1 1. Disconnect Switch

WARNING

PROPER GROUNDING

DO NOT attempt to start the machine until the electrical service is properly installed and grounded by a qualified electrician as per the electrical standards. Refer to Figure 14-2.

If the power supplied to the machine is not grounded properly, severe injury, or death can result should an electrical malfunction occur.

It is your responsibility to ensure that your power supplier and/or electrical contractor has grounded the irrigation machine as required by the National Electrical Code and by applicable local electrical codes. If a machine is properly grounded and fuse sizing is correct, there is extremely low probability of an individual being injured by electrical shock.

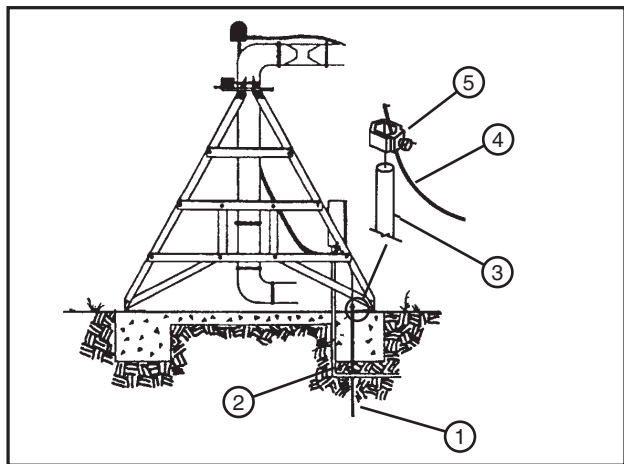

Figure 14-2 1. Ground Rod Installation 2. Service Conductor 3. Copper Ground Rod 4. Copper Ground Wire 5. Clamp

NOTE

- All 480 VAC, 60 Hz. (380 VAC, 50 Hz.) power supply services MUST be a 4 conductor service. Three 480 VAC (380 VAC) power lines and one ground conductor which is as large as the power carrying conductors for that service.
- Each time a towable machine is moved, the ground wire MUST be reattached to the ground rod and checked for electrical integrity before restarting the machine.

Operate Safely (Continued)

DANGER

DISCONNECT POWER WHEN SERVICING

ALWAYS disconnect electrical power before servicing or performing maintenance to the machine.

If you are going to perform maintenance on the machine, **YOU MUST** shut off and lock the main power disconnect as shown below. Refer to Figure 15-1.



Figure 15-1 1. Main Power Disconnect
2. Lock

The blue (OSHA safety color code) tag shown below should also be filled out and attached to the disconnect after locking. Refer to Figure 15-2.

The tag should reveal the name of a person to contact before restoring power to the machine.



Figure 15-2

CAUTION

QUALIFIED SERVICE PERSONNEL

If you do not understand electricity or other parts of the machine, have qualified service personnel perform any hazardous repairs or maintenance.

CAUTION

GUARD ALL POWER TAKE-OFF DRIVES

This includes all belt and power line drives.

Replace any guards and shields removed for maintenance.

WARNING

MARK AND GUARD ALL POWER LINES

Do NOT deep rip or chisel near the buried power service wires.

Do NOT deep rip in a circle at the drive unit. The deep chisel track will cause severe stresses on the structure.

If you do deep rip your field, run the machine with the percent timer at 100% for the first revolution.

WARNING

SUSPECTED SHORT CIRCUITS

DO NOT touch the machine if you suspect a short-circuit situation. Call a qualified electrician or an authorized Valley dealer immediately.

Circumstances which may cause you to suspect hazardous voltage situations may include:

- Physical damage to the machine or span cable
- Recent electrical storms (lightning)
- Unusual operating characteristics of the machine

If you suspect a short circuit due to feeling a rippling tingle when touching the machine, DO NOT touch the machine again. Call a qualified electrician or an authorized Valley dealer immediately.

Valley Select2 Control Panel

Safety

Operate Safely (Continued)

WARNING

LIGHTNING AND THE MACHINE

Stay away from the machine during an electrical storm. An irrigation machine makes a good path to earth. It is also probably the tallest object in the field, which makes it a good lightning receptor!

CAUTION

DO NOT OVERSIZE FUSES

Fuses are sized for the protection of a specific machine.

Be certain you have the proper fuse sizes in place before initial start-up and when replacing fuses.

CAUTION

PLUG - IN CONNECTORS

Disconnect power before connecting or disconnecting any plug-in connectors.

CAUTION

DO NOT OPERATE AT FREEZING TEMPERATURES

Spraying water has a cooling effect and water will freeze even though the air temperature is slightly above freezing.

Shut the machine down at 40 degrees Fahrenheit (4.5 degrees Celsius). Do not operate machine when temperature is below 40° F (4.5° C).

- **DAMAGE TO EQUIPMENT RESULTING FROM FREEZE-UP IS NOT COVERED UNDER WARRANTY.**
- **IT IS IMPORTANT TO MAKE SURE ALL PIPE DRAINS FUNCTION PROPERLY TO PREVENT PIPELINE FREEZE-UP DURING COLD WEATHER.**

CAUTION

AVOID HIGH PRESSURE WATER STREAMS

Avoid body contact with high pressure water streams.

WARNING

AVOID CHEMICALS

Avoid exposure to sprinkler spray while chemicals are being injected into the water. Read EPA Label Improvement Program (PR Notice 87-1) and all instructions for chemical applications.

If you plan on chemigating, make certain you have complied with state or local regulations in regard to safety equipment, certification, operation and calibration of the injector pump. Make certain you have first aid and fresh water available in case of an accident. You must also be familiar with the correct cleanup procedures in case of a spill.

- **USE OF PROTECTIVE CLOTHING IS RECOMMENDED WHEN HANDLING CHEMICALS. SAFETY GLASSES, GLOVES, AND PROTECTIVE OUTERWEAR SHOULD BE WORN WHEN HANDLING CHEMICALS.**
- **CONTAMINATION OF THE WATER SUPPLY MAY OCCUR IF EFFECTIVE SAFETY DEVICES ARE NOT INSTALLED/USED IN CONNECTION WITH INJECTION EQUIPMENT FOR CHEMIGATION.**

DANGER

DRIVE SHAFTS START WITHOUT WARNING

An electric motor on each tower of the center pivot powers two or more drive shafts connected to wheel gear drives. These drive shafts start and stop without warning.

- **DO NOT TOUCH ROTATING DRIVE SHAFT OR SHIELD, CLOTHING OR LIMBS MAY BECOME ENTANGLED, RESULTING IN SEVERE INJURY.**
- **DO NOT SERVICE THE MACHINE UNTIL THE MAIN DISCONNECT IS LOCKED IN THE OFF POSITION.**
- **ALWAYS REPLACE DRIVE SHAFT SHIELDS AFTER SERVICING.**
- **DRIVE SHAFT SHIELDS MUST ALWAYS BE IN PLACE WHEN OPERATING THE MACHINE.**

Operate Safely (Continued)

CAUTION

CHECK WHEEL TRACKS BEFORE STARTING

Make sure all objects, livestock or persons are clear of the machine before starting. Drive trains are powerful and can climb over vehicles, equipment, etc.

CAUTION

KEEP CHILDREN AWAY

Pivots are NOT playground equipment.

Prevent children from playing or climbing around on the machine. This can be extremely dangerous, especially if the machine is operating.

CAUTION

CHECK MACHINE DIRECTION

DO NOT operate the machine if it moves in the direction opposite to that which was chosen.

Forward should be clockwise, and reverse should be counter-clockwise.

CAUTION

KEEP WATER OFF ROADWAYS

It is against the law in most states to allow water to spray on state and county roadways. This is a serious hazard to passing motorists.

If end guns are used, make sure you read and understand the correct procedures for setting the on and off positions to avoid watering the roadways.

If an end gun is watering a roadway, immediately discontinue use and adjust the shutoff setting or call your Valley dealer to repair the end gun shut off mechanism.

CAUTION

PART CIRCLE OPERATION SAFETY

If the machine reverses direction at a roadway or a physical object such as a building, tree line, power pole, etc., then you MUST provide a backup device to stop the machine if the reversing mechanism were to fail. Refer to Figure 17-1.

Contact your Valley dealer for more information concerning physical barricades for machines under these circumstances.



Figure 17-1 1. Physical Barricade

CAUTION

PROPER USE OF THE SAFETY OVERRIDE

Caution MUST be taken by the operator when using the safety override function as it will bypass or disable all of the machine's automatic safety shutdown circuits.

- **NEVER DEPRESS AND HOLD THE START/STOP SAFETY OVERRIDE SWITCH IN THE START POSITION FOR MORE THAN 3 TO 5 SECONDS.**

If the machine is not in full view by the operator, do not use the Safety Override function.

The operator MUST inspect the entire machine between each safety override start attempt.

Repeated safety override start attempts can cause severe structural damage.

Call your Valley dealer if the machine fails to start.

Valley Select2 Control Panel

Safety

Safety Decals

These Danger, Warning, and Caution decals appear in various locations on a Valley irrigation machine. You MUST familiarize yourself and other operator's with these safety decals. For replacement of any decal, contact your local Valley dealer.

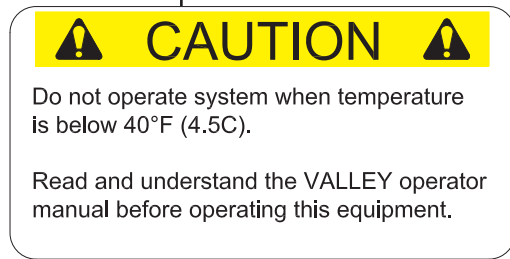
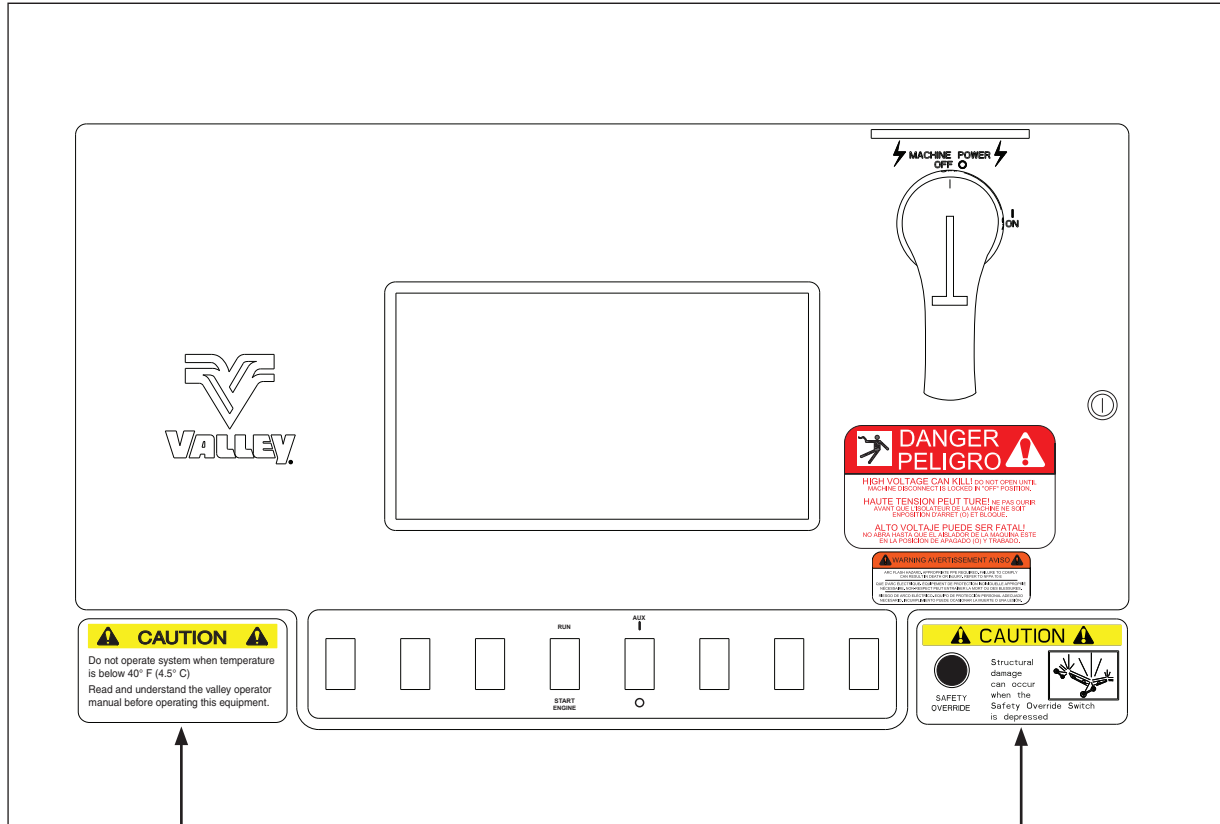

0997300

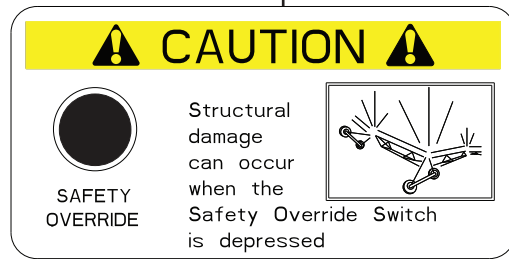

Not Available



0999135



Safety Decals (Continued)

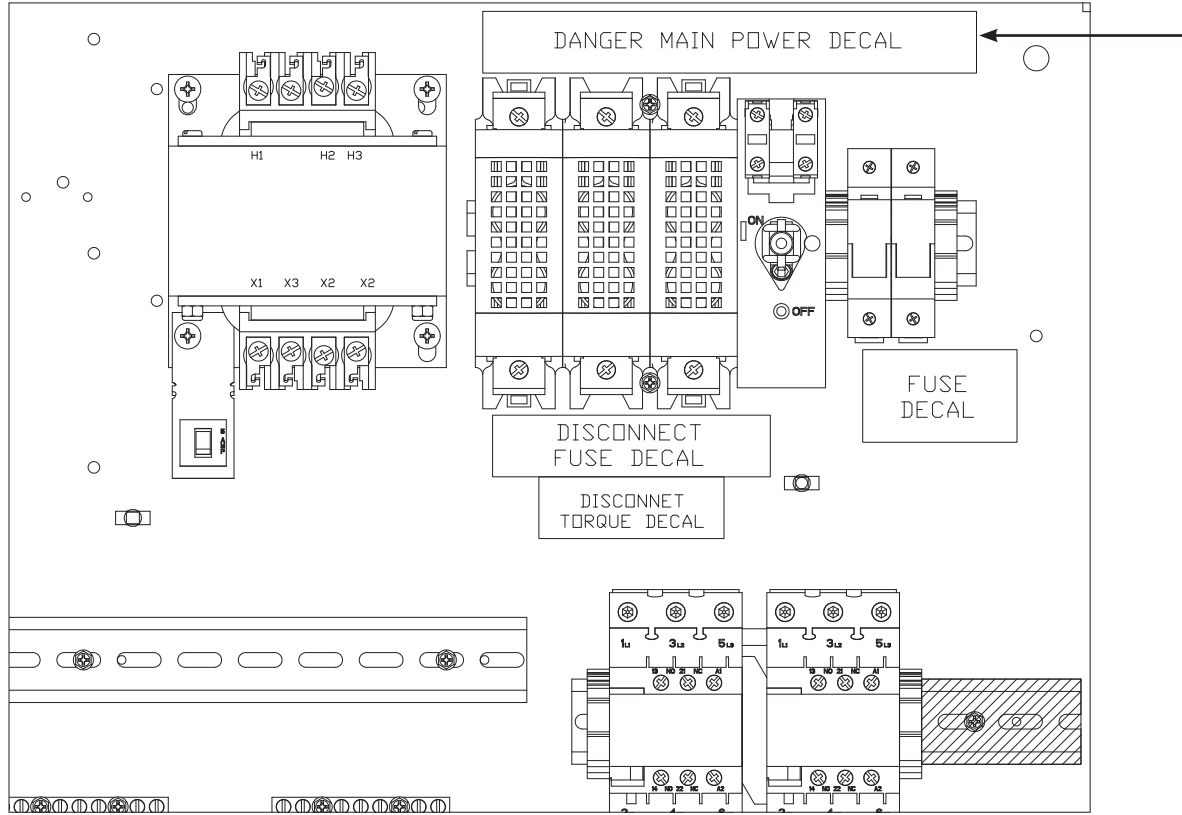

	DANGER PELIGRO	BRANCHEMENT DE L'ALIMENTATION ÉLECTRIQUE PRINCIPALE UTILISER DU FIL DE CUIVRE ISOLATION 60 °C MINIMUM
	MAIN POWER SUPPLY CONNECTION USE 60°C MINIMUM INSULATION COPPER WIRE L1 L2 L3	CONEXIÓN DEL SUMINISTRO DE ENERGÍA ELÉCTRICA PRINCIPAL UTILICE CABLES DE COBRE CON AISLAMIENTO PARA 60 °C MÍNIMO

0999119

DANGER

HIGH VOLTAGE

DO NOT OPEN UNLESS PIVOT
DISCONNECT SWITCH IS IN
THE "OFF" POSITION

0991148

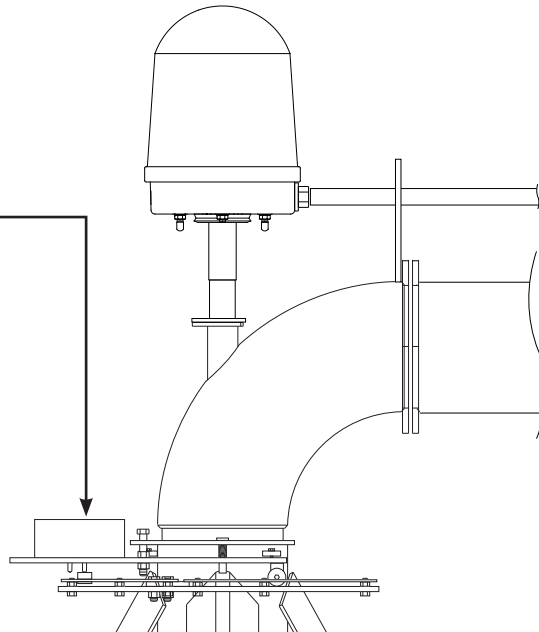

Valley Select2 Control Panel

Safety

Safety Decals (Continued)

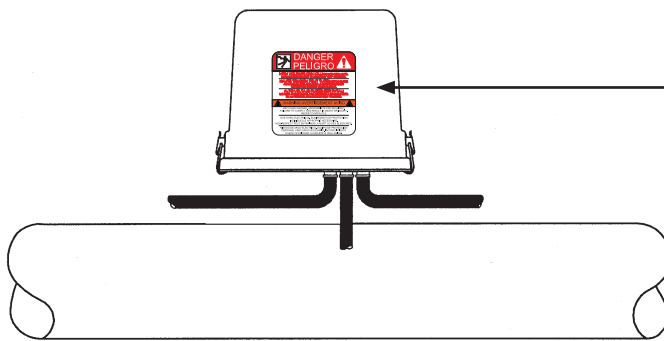

	DANGER	
HAUTE TENSION PEUT TUE! NE PAS OUIR AVANT QUE L'ISOLATEUR DE LA MACHINE NE SOIT EN POSITION D'ARRET (O) ET BLOQUE.		
ALTO VOLTAJE PUEDE SER FATAL! NO ABRA HASTA QUE EL AISLADOR DE LA MAQUINA ESTE EN LA POSICION DE APAGADO (O) Y TRABADO.		
	WARNING AVERTISSEMENT AVISO	
ARC FLASH HAZARD, APPROPRIATE PPE REQUIRED. FAILURE TO COMPLY CAN RESULT IN DEATH OR INJURY. REFER TO NFPA 70 E		
QUE D'ARC ÉLECTRIQUE. ÉQUIPEMENT DE PROTECTION INDIVIDUELLE APPROPRIÉ NÉCESSAIRE. NON-RESPECT PEUT ENTRAÎNER LA MORT OU DES BLESSURES.		
RIESGO DE ARCO ELÉCTRICO. EQUIPO DE PROTECCIÓN PERSONAL ADECUADO NECESARIO. INCUMPLIMIENTO PUEDE OCASIONAR LA MUERTE O UNA LESIÓN.		

0999122

	WARNING
TIRE AND RIM FOR IRRIGATION USE ONLY. ADJUST PRESSURE BEFORE USE. SEE OWNERS MANUAL FOR RECOMMENDED PRESSURE. 18 PSI [1.2 BAR] MAXIMUM	
VALLEY.	

0991532

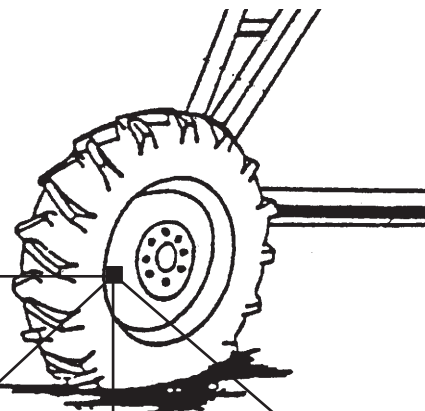

	WARNING
TIRE AND RIM FOR IRRIGATION USE ONLY. ADJUST PRESSURE BEFORE USE. SEE OWNERS MANUAL FOR RECOMMENDED PRESSURE. 23 PSI [1.6 BAR] MAXIMUM	
VALLEY.	

0991593

	WARNING
TIRE AND RIM FOR IRRIGATION USE ONLY. ADJUST PRESSURE BEFORE USE. SEE OWNERS MANUAL FOR RECOMMENDED PRESSURE. 30 PSI [2.1 BAR] MAXIMUM	
VALLEY.	

0991366

	WARNING
TIRE AND RIM FOR IRRIGATION USE ONLY. ADJUST PRESSURE BEFORE USE. SEE OWNERS MANUAL FOR RECOMMENDED PRESSURE. 34 PSI [2.3 BAR] MAXIMUM	
VALLEY.	

0996109

Safety Decals (Continued)

⚠ WARNING	
Improper installation of this motor may result in fire, explosion, electrical shock or other personal injuries. Read operating instructions	
	Disconnect power before maintenance. Open all circuits before removing conduit box cover. Be sure motor is properly grounded per local and national codes.
	Do not place fingers or objects near openings.
	Do not use eye bolts or lifting hooks to lift anything except the product.

Not Offered

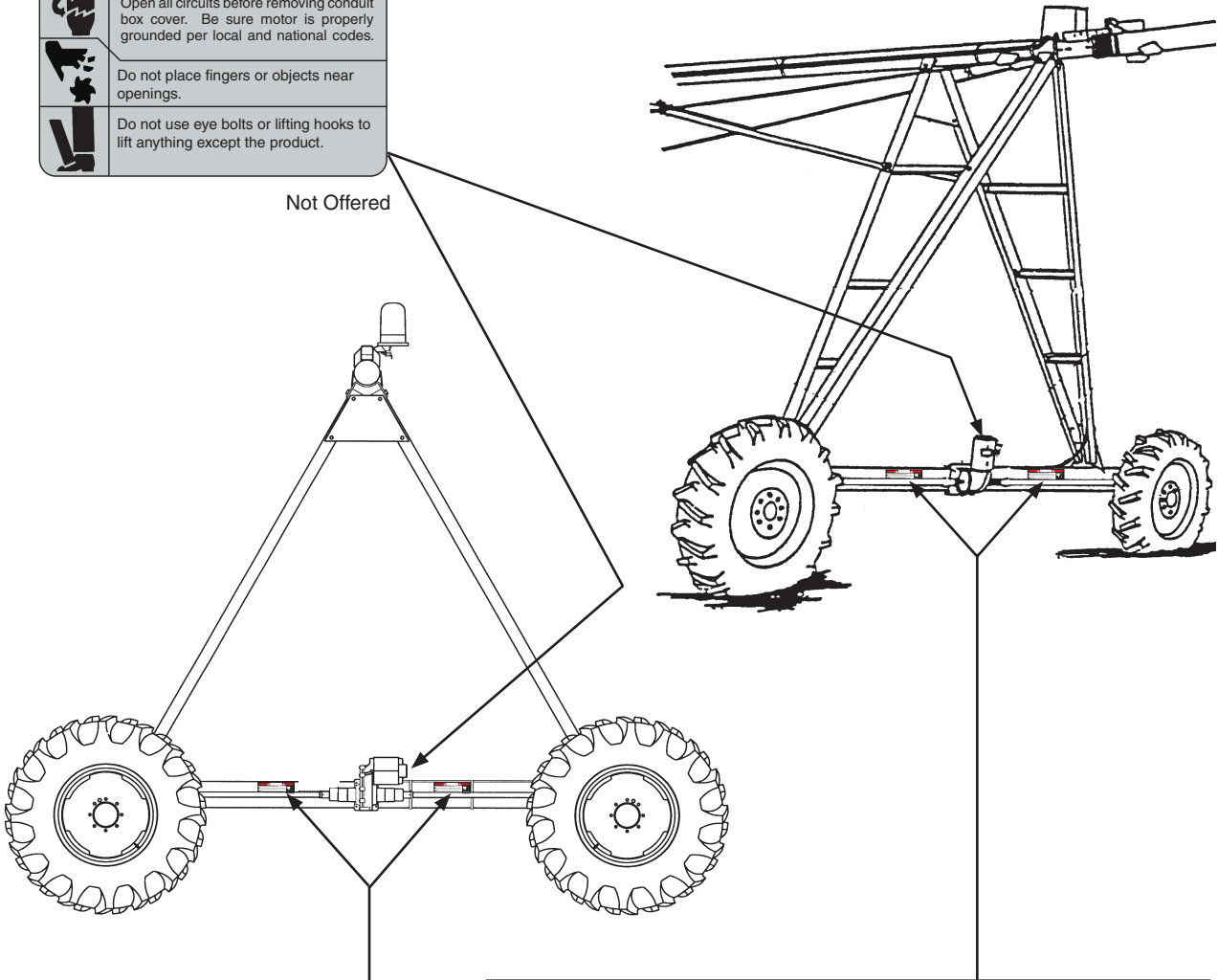

⚠ DANGER ⚠	
Drive Shaft Starts Without Warning!	
<ul style="list-style-type: none">▪ Do not touch rotating drive shaft or shield. Clothing or limbs may become entangled, resulting in severe injury.▪ Do not service until machine is locked in the off position.▪ Always replace drive shaft shield after servicing.	

0994146

Valley Select2 Control Panel

Safety

The pages in this section provide a brief description of the Valley Select2 control panel components and controls.

Control Panel

This Valley control panel uses a Select2 module with a key pad for execution of operator commands. The key pad works in conjunction with the display screen on the module. See figure 23-1.

Main Disconnect

This switch disconnects all power to the machine except at the incoming (upper) terminals on the Main Disconnect Switch inside the control panel. The function of the disconnect is to turn the power ON or OFF. See figure 23-1.

Safety Override Switch

The machine's safety circuit can be overridden by depressing this switch in conjunction with the start key. See figure 23-1.

3 Second Delay Timer

A three-second delay timer is standard equipment built into the circuitry of the control panel.

In the event of a momentary power loss or voltage drop, the machine will remain running if power is returned within three seconds.

WARNING

- NEVER DEPRESS THE SAFETY OVERRIDE SWITCH FOR LONGER THAN THREE SECONDS AT ANY TIME. USING THE SAFETY OVERRIDE CAN CAUSE SERIOUS STRUCTURAL DAMAGE. CALL YOUR LOCAL VALLEY DEALER, SHOULD YOUR MACHINE FAIL TO START.

Pump Restart Delay

When the control panel also controls an irrigation pump that is set to automatically start, the irrigation pump must be protected from damage with a pump restart delay. The pump restart delay must be in the pump circuit between the irrigation machine control panel and the pump.

CAUTION

- TO REDUCE THE POSSIBILITY OF DAMAGE TO AN AUTOMATICALLY CONTROLLED ELECTRIC PUMP DUE TO A MOMENTARY POWER LOSS OF 3 SECONDS OR LESS, A PUMP RESTART DELAY IS REQUIRED IN THE PUMP CIRCUIT BETWEEN THE IRRIGATION MACHINE CONTROL PANEL AND THE PUMP.

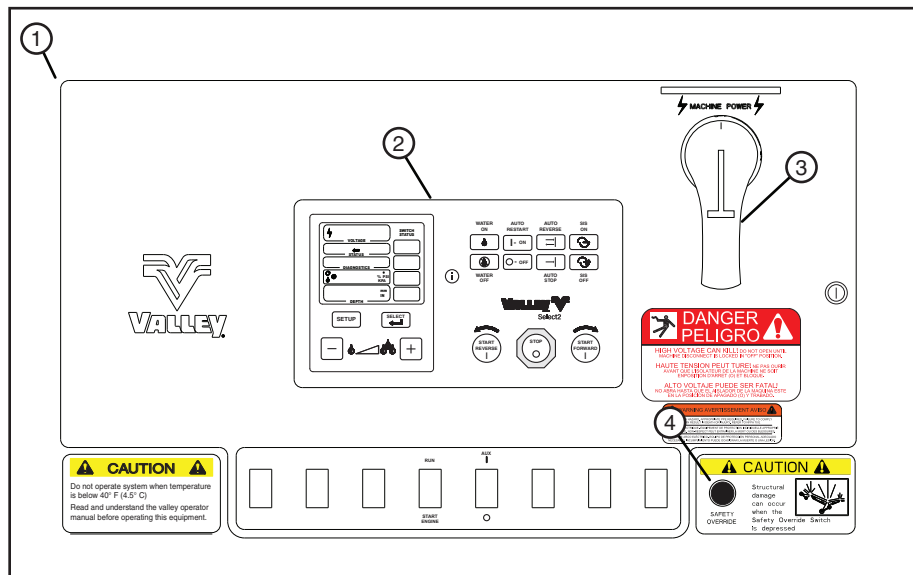

Figure 23-1 1. Control Panel
2. Select2 Module

3. Main Disconnect Switch
4. Safety Override Switch

Valley Select2 Control Panel

Overview

Control Panel Display - Item 1

The control panel display is used to show current machine status and information for programming and selecting functions. When the control panel main disconnect is turned on and at all other times when the operator is not programming the control panel, the control panel display shows the current machine status. See figure 24-1. A short explanation of the display screen elements is given below and on the following pages.

NOTE

•This Display screen example illustrates all of the indicators of an irrigation machine. The Display screen of your machine will show different conditions.

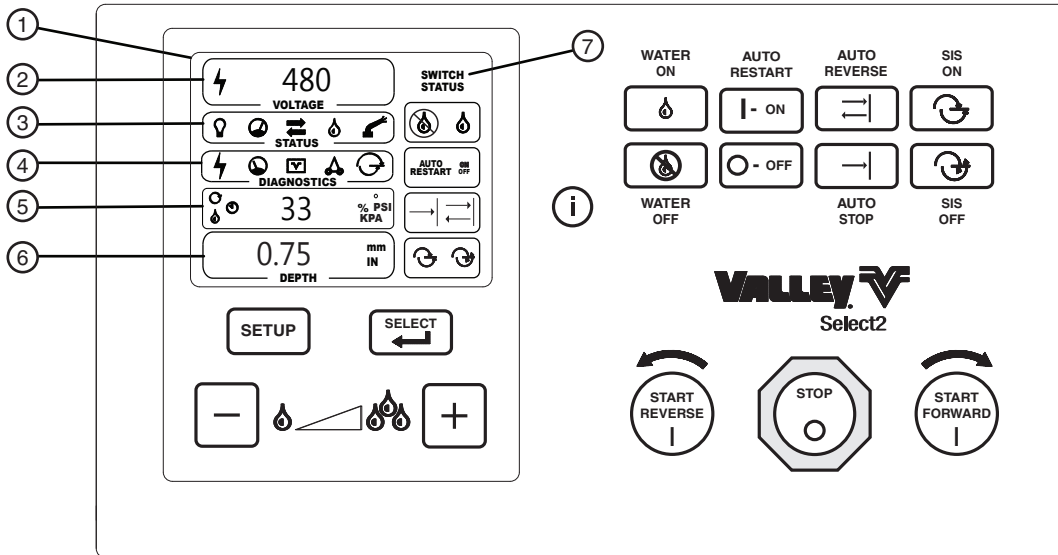



Figure 24-1 1. Control Panel Display
2. Voltage Display
3. Run Status Display
4. Diagnostics Display

5. Multiple Information Display
6. Water Application Display
7. Switch Status Indicators

Voltage Display - Item 2

Indicates the current operating voltage. See figure 24-1.

 Indicates adequate voltage, between the low voltage setting and 505 VAC.

Run Status Display - Item 3

Indicates the current running conditions. See figure 24-1.

The following is a list of the symbols which may appear and an explanation for what each represents:

 Machine is running. If the machine is off, this symbol will not appear.

 Indicates water pressure is above the low pressure setting. This symbol will flash on and off when the machine is first started. When the water pressure reaches the low pressure setting, the symbol will stop flashing.

 The machine is moving in the forward (clockwise) position.

 The machine is moving in the reverse (counter-clockwise) position.



Water ON has been selected. The machine will apply water by either opening a valve, starting a pump, or by other means of supplying water. If water OFF has been selected, this symbol will not appear.



End gun is commanded on.

Diagnostics Display - Item 4

Indicates a system shutdown and will display one or more of the five symbols to identify the cause of the shutdown. Refer to the DIAGNOSTICS section for a detailed explanation. See figures 24-1 and 24-2



Figure 24-2

Multiple Information Display - Item 5

Multiple information display, by pressing the "i" button, to toggle between showing water pressure, timer percentage, hours per revolution, hours wet, total hours, and current position. See figure 24-1. Each of the status reports are explained next.

Control Panel Display

Multiple Information Display - Item 5 (Continued)

Pressure Readout

Indicates the water pressure in (PSI) pounds per square inch at the location of the pressure transducer (device which determines the pressure). This value can also be displayed in (KPa) kilo pascals if the operator desires. See figure 25-1.

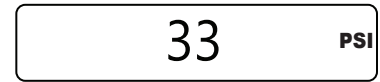

Figure 25-1

Percent Timer Setting

Displays the percentage timer setting. See figure 25-2.



Figure 25-2

NOTE

- The percentage timer setting regulates the amount of water being applied when WATER ON is selected due to the speed of the machine.
- The percentage timer setting regulates the speed of the machine when WATER OFF is selected.

Hours Per Revolution

Displays the approximate hours required for the equipment to make one complete revolution. Figure 25-3 indicates that the equipment will make one complete revolution in approximately 48 hours. If the operator changes the application depth by pressing the Applicator Depth buttons, the hours per revolution display will change accordingly.



Figure 25-3

- Indicates time or hours.
- Indicates per revolution of the pivot.
- Displayed together, the two symbols indicate "Hours per Revolution".

Hours Wet

Displays hours the machine has run with water. This value can be reset by pressing and holding the SELECT button for 5 seconds, then releasing the SELECT button to reset to 0 hours while Hours Wet is displayed on the screen. See figure 25-4.

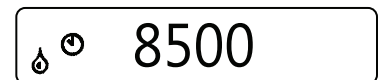

Figure 25-4

- Indicates time or hours.
- Indicates machine was running with water or "Wet".
- Displayed together, the two symbols indicate "Hours Wet".

Total Hours

Displays total hours the machine has run, with and without water. This value cannot be reset without hard resetting the module. See figure 25-5.

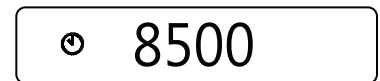

Figure 25-5

- Indicates time or hours.
- When displayed by itself, indicates "Total Hours".

Current Position

Displays the position of the machine. North is generally defined as the 0° reference point but any convenient location can be specified. See figure 25-6.

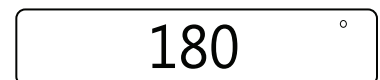

Figure 25-6

Flow Meter

When flow meter is on, additional information will be displayed: Flow, Total Flow (Mil. Gal.), and Pulse Count. See figure 25-7.

- Indicates machine was running with water or "wet".
- Indicates per revolution of the pivot.

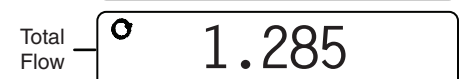
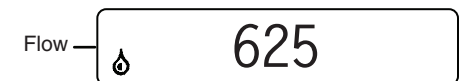

Figure 25-7

Water Application Display - Item 6

Displays the amount of water being applied. 0.00 IN will be displayed if WATER OFF is selected. This value can also be displayed in millimeters if the operator desires. See figure 25-8.



Figure 25-8

Valley Select2 Control Panel

Overview

Control Panel Display

Switch Status Indicators - Item 7

Indicates status of the switches. Each of the switch status indicators will be displayed in the multiple information displays for 2 seconds after a switch is activated before returning to the default displays.

Water Off

Display in figure 26-1 is on after the WATER OFF switch is pressed. The switch status in row 1 will remain lit as shown while the water is off.

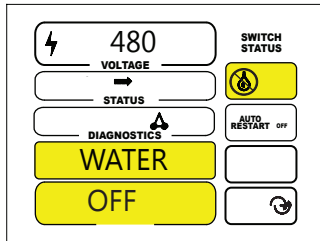

Figure 26-1

Auto Stop

Display in figure 26-5 is on after the AUTO STOP switch is pressed. The switch status in row 3 will remain lit as AUTO STOP is activated.

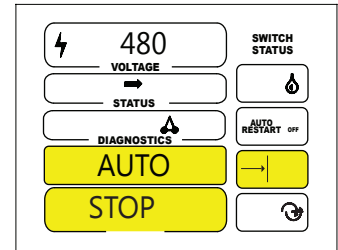

Figure 26-5

Water On

Display in figure 26-2 is on after the WATER ON switch is pressed. The switch status in row 1 will remain lit as shown while the water is on.

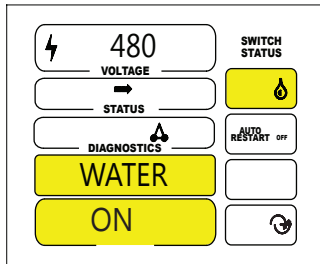

Figure 26-2

Auto Reverse

Display in figure 26-6 is on after the AUTO REVERSE switch is pressed. The switch status in row 3 will remain lit as AUTO REVERSE is activated.

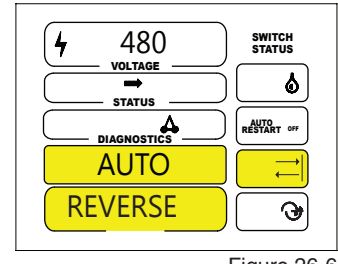

Figure 26-6

Auto Restart On

Display in figure 26-3 is on after the AUTO RESTART ON switch is pressed. The switch status in row 2 will remain lit as shown while the auto restart is activated.

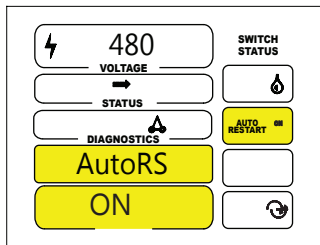

Figure 26-3

AR/AS Disabled

The display in figure 26-7 shows DISABLED when AR-AS (Auto Reverse/Auto Stop) is set to OFF in Setup Group 4.

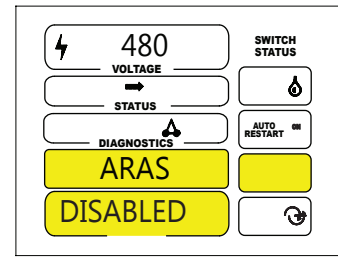

Figure 26-7

Auto Restart Off

Display in figure 26-4 is on after the AUTO RESTART OFF switch is pressed. The switch status in row 2 will remain lit as shown while the auto restart is deactivated.

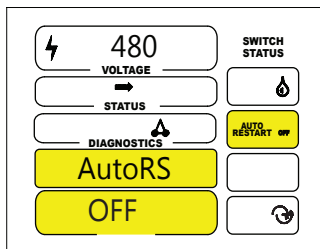

Figure 26-4

Stop In Slot On

Display in figure 26-8 is on after the SIS ON switch is pressed. To re-display the SIS location, alternate pressing the SIS ON and OFF switches. The switch status in row 4 will remain lit as shown while the SIS is on.

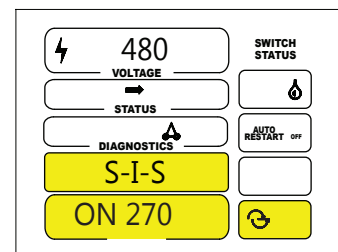

Figure 26-8

Stop In Slot Off

Display in figure 26-9 is on after the SIS OFF switch is pressed. The switch status in row 4 will remain lit as shown while the SIS is off.

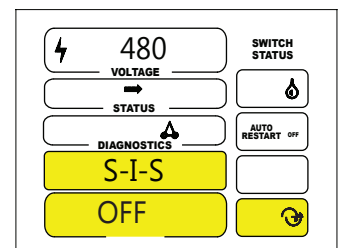

Figure 26-9

Control Panel Switches

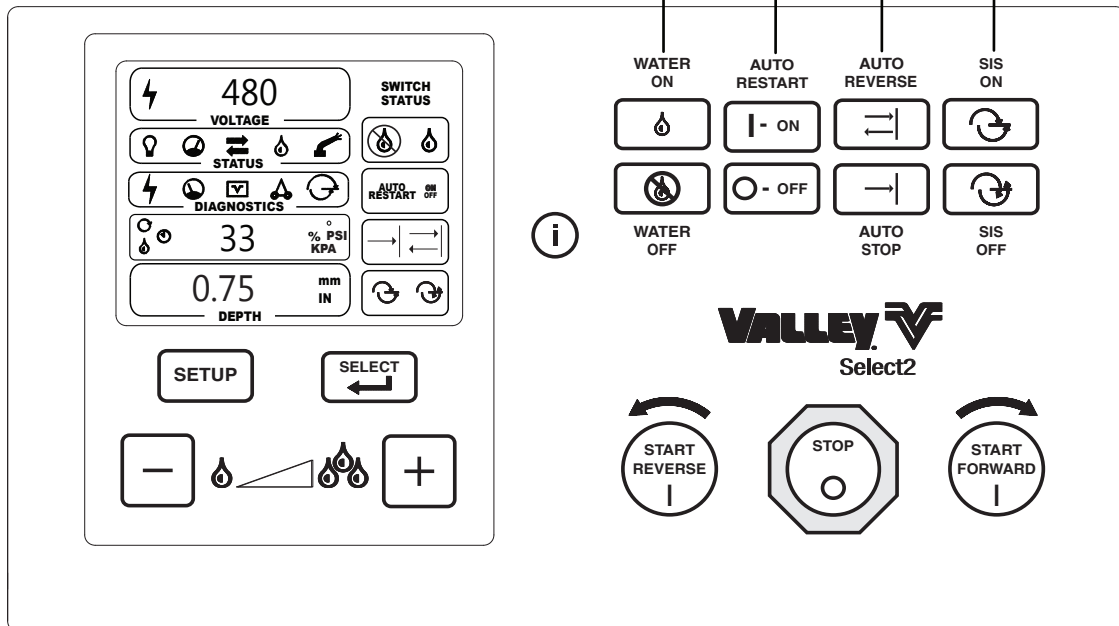

Figure 27-1 1. Water On/Off Switches
2. Auto Restart On/Off Switches

3. Auto Reverse/Auto Stop Switches
4. Stop-In-Slot On/Off Switches

Water On/Off Switches - Item 1

Enables the current setting for applying water to be either on or off. See figure 27-1.



Press to run the machine with the water on.



Press to run the machine with the water off.

Auto Restart On/Off Switches - Item 2

Enables the current Auto Restart setting to be either on or off. See figure 27-1.



Press to enable the machine to restart after loss of power or water pressure.



Press to disable the machine to restart after loss of power or water pressure.

Auto Reverse/Auto Stop Switches - Item 3

The Auto Reverse and Auto Stop switches are enabled when AR-AS in Setup Group 4 is set to ON, switches are used with drive unit mounted AR/AS mechanism or forward position/reverse position. See figure 27-1.

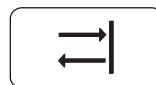

Press to turn Auto Reverse on.

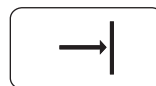

Press to turn Auto Stop on.

Stop-In-Slot On/Off Switches - Item 4

Enables the current Stop-In-Slot setting to be either on or off. See figure 27-1.



Press to run the machine with the SIS on.



Press to run the machine with the SIS off.

Valley Select2 Control Panel

Overview

Control Panel Buttons

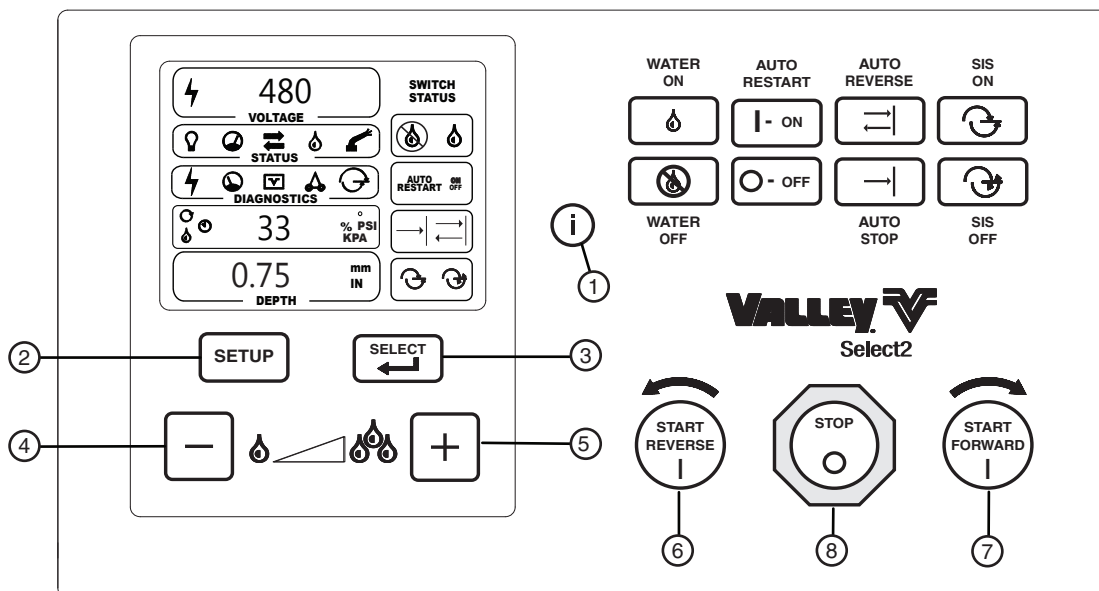

Figure 28-1 1. "i" Information Button 4. Application Depth Button "-" 7. Start/Forward Button
 2. Setup Button 5. Application Depth Button "+" 8. Stop Button
 3. Select Button 6. Start/Reverse Button

"i" Information Button - Item 1

Pressing this button toggles between the multiple displays of the Multiple Information Display and exits the operator out of a setup group. See figure 28-1.

Setup Button - Item 2

Pressing or holding this button at any time toggles between the setup groups. See figure 28-1.

- Press 1 time or for 1.5 seconds to access group 1.
- Press 2 times or for 3 seconds to access group 2.
- Press 3 times or for 4.5 seconds to access group 3.
- Press 4 times or for 6 seconds to access group 4.
- Press 5 times or for 7.5 seconds to access group 5.
- Press 6 times or for 9 seconds to access group 6.
- Press 7 times or for 10.5 seconds to access group 7.
- Press 8 times or for 12 seconds to access group 8.
- Press 9 times return to the main screen.

Select Button - Item 3

Pressing this button moves the operator to the next value within a setup group. See figure 28-1.

Application Depth Buttons "-" and "+" - Items 4 & 5

Pressing either of these buttons will decrease or increase the water application. Pressing either button is used to change the values within the setup groups. See figure 28-1.

Start/Reverse Button - Item 6

Enables the operator to start the machine in the reverse (counter-clockwise) direction assuming all safety circuits are complete. See figure 28-1.

Start/Forward Button - Item 7

Enables the operator to start the machine in the forward (clockwise) direction assuming all safety circuits are complete. See figure 28-1.

NOTE

- The machine has a built in time delay that will not allow it to be restarted by pressing the Forward or Reverse Start buttons within five seconds after being stopped.

Stop Button - Item 8

Enables the operator to stop the machine and shut the pump off/close the water valve. This is assuming the pump/water valves are wired such that when the machine stops, the pump shuts off or the water valve (if present) closes automatically. See figure 28-1.

Option Switches

The Select2 panel has seven slots for optional switches. See figure 29-1.

Engine Run/Start

A standard engine RUN/START switch is installed for wiring of the engine shutdown circuit. If the switch is in the RUN position, the engine would shut down if the machine stops for some reason. The switch **MUST** be in the START position to start the engine and to get the machine started. See figure 29-2.

Auxiliary On/Off

This optional switch is available for such uses as an injector pump operation or other options the operator may decide to install. See figure 29-3.

Auto/Off/Test

This optional switch is available to turn the end gun OFF or manually test if the end gun is operating correctly. The switch is spring loaded in the TEST position. See figure 29-4.

IMPORTANT: Placing the switch in the OFF position will disable end gun operation until the switch is placed in the AUTO position. Crop damage may occur if left in the OFF position.

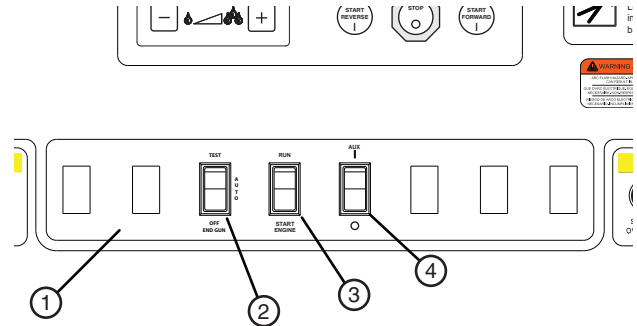

Figure 29-1 1. Expansion Slots
2. (Optional) End gun Test
3. Standard
4. (Optional) Auxiliary Control

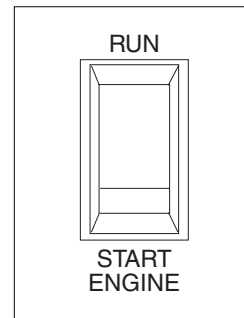

Figure 29-2

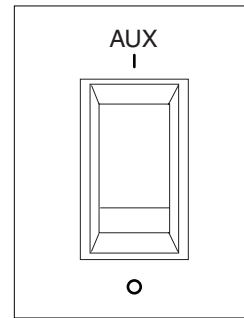

Figure 29-3

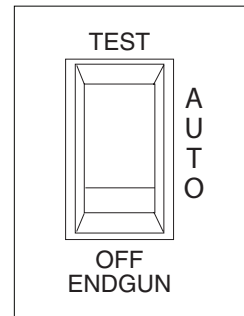

Figure 29-4

Valley Select2 Control Panel

Overview

Valley Select2 Control Panel

Control Panel Setup

Setup the control panel for use by completing the Minimum Control Panel Setup.

Reference tables are included in this section for Voltage, Low Voltage, Estimated Drive Speed and GPS Angular Conversion of minutes and seconds into decimal degrees.

Listed below are the setup and reference table locations.

Control Panel Setup	31
Minimum Control Panel Setup.....	33
Setup GPS Using Manual Method (Machines With GPS).....	35
Setup GPS Position Loss Shutdown	36
Test and Adjust GPS Position.....	37
Voltage.....	38
Low Voltage	38
Estimated Drive Unit Speed Table	38
GPS Angular Conversion Table	39
Angular Degree Examples.....	39



























If desired, control panel settings and programs can be recorded on the Setup Record or Program Design forms in the Appendix of this manual.

Valley Select2 Control Panel

Control Panel Setup

Minimum Control Panel Setup





















To setup the control panel for use do the following:

1. Set the Unit of Measure. The default is Standard (inches).
 - a) From the main screen, press and hold  until Setup Group 4 is displayed or press  four times.
 - b) Press  repeatedly until UNITS is displayed.
 - c) Press  or  and select either Standard (inches) or Metric.
 - d) Press  to advance to Language.
2. Set the Language. The default is English.
 - a) LANGUAGE should be flashing.
 - b) Press  or  and select the desired Language.
 - English • Espanol • Francois • Italiano • Portugues
 - c) Press  to go back to the status screen.
3. Set the Current Time. Enter the time in the 24 hour format.
 - a) From the main screen, press and hold  until Setup Group 7 is displayed or press  seven times.
 - b) Press  one time to advance to the hours field.
 - c) The hours field should be flashing.
 - d) Press  or  to set the hours.
 - e) Press  to advance to the minutes field.
 - f) The minutes field should be flashing.
 - g) Press  or  to set the minutes.
 - h) Press  to advance to the first date field.
4. Set the current Date. The date format is determined by the unit of measure setting.
 - When the Unit of Measure is set to Standard, enter the date in a mm/dd/yy format.
 - When unit of measure is set to Metric, enter the date in a dd/mm/yy format.
 - a) The first date field should be flashing.
 - b) Press  or  to set the month (Standard) or day (Metric).
 - c) Press  to advance to the second date field.
 - d) The second date field should be flashing.
 - e) Press  or  to set the day (Standard) or month (Metric).
 - f) Press  to advance to the third date field.
 - g) The third date field should be flashing.
 - h) Press  or  to set the either the year.
 - i) Press  to go back to the status screen.

Valley Select2 Control Panel

Control Panel Setup

Minimum Control Panel Setup (continued)

5. Set the Minimum Application depth of water applied. This value is found on the VChart Report. Range is 0.01 in to 1.00 in or 0 to 25.4 mm of water and default value is 0.25 in.
 - a) From the main screen, press and hold  until Setup Group 4 is displayed or press  four times.
 - b) Press  one time to advance to minimum application.
 - c) LowAPP should be flashing.
 - d) Press  or  to change the value.
 - e) Press  to advance to Low Hours.
6. Set Low Hours Per Revolution/the number of hours required for the machine to make one complete revolution at a percentage timer setting off 100%. This value is found on the VChart Report. Range is 0.1 to 240.0 hours and default value is 24.
 - a) Low HR should be flashing.
 - b) Press  or  to change the value.
 - c) Press  to advance to Low Pressure.
7. Set Low Pressure limit. Range is 0 to 100 and default value is 15.
 - a) LowPSI should be flashing.
 - b) Press  or  to change the value.
 - c) Press  to advance to Voltage Calibration.
8. Set Voltage Calibration.
 - a) CAL V should be flashing.
 - b) Press  or  to change the voltage value. See Voltage on page 38.
 - c) Press  to advance to Low Voltage.
9. Set Low Voltage limit.
 - a) Low V should be flashing.
 - b) Press  or  to change the low voltage limit. See Low Voltage on page 38.
 - c) Press  two times to advance to Position.
10. Program the position related control panel settings based on how the machine is equipped:
 - If the machine is NOT equipped with GPS Position Sensing, continue with STEP 11 on this page and set the position value to complete the minimum control panel setup for a machine without GPS Position.
 - If the machine is equipped with GPS Position Sensing, use SET GPS USING MANUAL METHOD on the next page and set the pivot point position and fallback run time to complete the minimum control panel setup for a machine with GPS Position.
11. Set the Position value in degrees.
 - a) POSITION should be flashing.
 - b) Press  or  to change the value.
 - c) Press  to go back to the status screen. Minimum control panel setup is complete.









Minimum Control Panel Setup (continued)

Setup GPS Using Manual Method (Machines With GPS)



















To setup the GPS position type using EDIT, do the following.

- Obtain the last tower speed and pivot length information from the VChart report for this machine or measure the span length from pivot to last regular drive unit not including the overhang and use the Estimated Drive Unit Speed chart in this section.
- Use a handheld GPS receiver to obtain the GPS coordinates for the Pivot Point position.
- If necessary, use the GPS Angular Conversion chart in this section to convert the GPS coordinate values into decimals of degree.



1. Change the 25-Pin Com Port settings in setup GROUP 5 - COM PORT:

- a) Set the 25-Pin Com Port Baud Rate to 4800 baud.
- 1) Press  five times to access Setup GROUP 5.
 - 2) Press  repeatedly and scroll to BAUD 25-PIN.
- b) Press  or  and adjust value to 4800 baud. Set the 25-Pin Com Port protocol to GPS V1 or V2.
- 1) Press  and scroll to PROTOCOL 25-PIN.
 - 2) Press  or  and adjust value to GPS V1 or V2.
 - 3) Press  to go back to the status screen.

2. Set the GPS values in setup GROUP 8 - GPS.

- a) Set the Pivot Point position using EDIT.
- 1) Press  eight times to access Setup GROUP 8.
 - 2) Press  repeatedly to select PIVOT POINT.
 - 3) Press  or  to select EDIT.
 - 4) Press  to access the Latitude screen.
 - 5) Press  or  to enter the latitude.
 - 6) Press  to access the Longitude screen
 - 7) Press  or  to enter the longitude.
- b) Set the Fallback Position to Run Time.
- 1) Press  to select FALLBACK POS.
 - 2) Press  or  to select RUN TIME.
 - 3) Press  to access the Length screen.
 - 4) Press  or  to enter the pivot LENGTH. The default is 1320 ft (402.3 m).
 - 5) Press  to access the Speed screen.
 - 6) Press  or  to enter the pivot SPEED. The default is 15.56 ft/min (4.732 m/min).

NOTE

- Latitude and Longitude positions displayed on a handheld GPS receiver are usually displayed as North, South, East or West.
- The direction displayed affects how the position is entered into the control panel.
- If the position is shown as West or South the position MUST be entered as a Negative Degree.
- In North America:
 - Latitude positions are always Positive.
 - Longitude positions are always Negative.
- Adjustment of any numeric value can be accelerated by continuously pressing  or .
- After setup, if the pivot point position is shown incorrectly as 90° or 270°, make sure that the positive or negative value was entered correctly.

NOTE











- SET should only be used by an authorized Valley Dealer.
- SET requires the connection of additional hardware to the control panel and is NOT recommended for use by the owner/operator or any unqualified person.

Valley Select2 Control Panel

Control Panel Setup

Minimum Control Panel Setup (continued)

Setup GPS Using Manual Method (Machines With GPS)

- c) Set the length to GPS receiver and tolerance.
 - 1) Press  to access the Length to GPS screen.
 - 2) Press  or  to enter the length from the pivot point to GPS receiver. Do not enter the pivot length. The range is 10 to 6554 ft (3.0 to 1997.6 m). Default is 1320 ft (402.3 m).
 - 3) Press  to access the Length Minus tolerance screen.
 - 4) Press  or  to enter the minus tolerance for the length from the pivot point to GPS receiver. The Default is 50 ft (15.2 m) and the range is 10 to 6554 ft (3.0 to 1997.6 m). A setting of 50 ft (15.2 m) or more is recommended to allow for variation in the GPS signal if WAAS is unavailable.
 - 5) Press  to access the Length Plus tolerance screen.
 - 6) Press  or  to enter the plus tolerance for the length from the pivot point to GPS receiver. The Default is 50 ft (15.2 m) and the range is 10 to 6554 ft (3.0 to 1997.6 m). A setting of 50 ft (15.2 m) or more is recommended to allow for variation in the GPS signal if WAAS is unavailable.
 - 7) Press  to go back to the status screen.







3. Continue with SETUP GPS LOSS SHUTDOWN on this page.

Setup GPS Position Loss Shutdown

In the event of GPS position Loss, 3 different position loss functions can be used to control the machine operation. Listed below are the functions and their default settings.





- Shutdown System Timer: When GPS Loss Shutdown is set to STANDARD or DGPS, the No GPS Off Delay shuts the system down if GPS position is lost for a specified period of time. Default setting is a 20 minute delay. Range is OFF to 255 minutes.
- Disable End guns Timer: When GPS Loss Shutdown is set to STANDARD or DGPS, the No GPS End gun Off Delay disables the end guns if GPS position is lost for a specified period of time. Default setting is OFF. Range is OFF to 255 minutes.
- GPS Loss Shutdown: When GPS Loss Shutdown is set to STANDARD or DGPS signal type and the selected GPS signal type is lost, the system is shut down immediately unless a time delay is specified in either the Shutdown System timer or the Disable End guns timer. Default setting is OFF. Available settings are OFF, STANDARD and DGPS.

If desired set the GPS Position Loss Shutdown values in setup GROUP 8 - GPS.

1. Press  eight times to access Setup GROUP 8.
2. Press  repeatedly to select NO GPS OFFdly (System Shutdown Timer).
3. If desired set the Shutdown System Timer.
 - Press  or  to adjust time delay. Default is 20 minutes. Range is OFF to 255 minutes.
4. Press  to select NoGPS EG OFFdly. (Disable End gun Timer)
5. If desired set the Disable End gun Timer.
 - Press  or  to adjust time delay. Default is OFF minutes. Range is OFF to 255 minutes.

Continued on next page.

Minimum Control Panel Setup (continued) Setup GPS Position Loss Shutdown







6. Press  to select GPS LOSS SHTDWN.
7. If desired set the GPS Loss Shutdown.
 - Press  or  to select DGPS, STANDARD or OFF. Default is OFF. Available settings are OFF, STANDARD and DGPS.
8. Press  to go back to the status screen. When done setting up GPS Position Loss Shutdown, proceed to TEST and ADJUST GPS POSITION.

Test and Adjust GPS Position

If the machine is equipped with GPS position do the following to verify that GPS position is working.

NOTE

- Initially it may be necessary to run the machines in both directions so that the position displayed on the screen is accurate.
- When the direction of travel changes the position is updated with the GPS position.

1. View the Position screen in Setup Group 4. See figure 37-1.
 - a) Press  four times to access Setup GROUP 4 - CONSTANT
 - b) Press  repeatedly to view the POSITION screen. To use north as 0 degrees, both unfiltered and filtered positions must match.
2. The Position screen displays the following information:
 - a) Current unfiltered position of machine.
 - b) Current filtered position of machine.
3. If a GPS signal is not found, NO GPS will be displayed. See figure 37-2.
4. Run machine in either direction to verify that the position displayed on the status screen changes periodically as the machine moves.
 - If GPS position is not working see the Troubleshooting section.
 - If GPS position is working, the installation is complete.
5. If 0 degrees north is not desired set the position of the pivot span in degrees. Position value is located in setup GROUP 4. Must have GPS Lock in order to edit position. Default is 0 degrees, machine pointing north.
 - a) Press  four times to access Setup GROUP 4 - CONSTANT.
 - b) Press  repeatedly to select POSITION.
 - c) Press  or  to enter the pivot span position in degrees.
 - d) Press  to go back to the status screen.

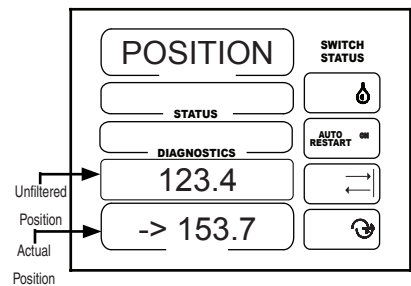

Figure 37-1

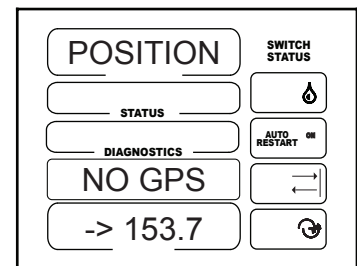

Figure 37-2

Valley Select2 Control Panel

Control Panel Setup

Voltage

The Voltage constant calibrates the volt meter with the actual voltage coming into the control panel so that the voltage fluctuations can be monitored correctly.

The incoming voltage to the control panel must be measured with a meter by a qualified electrician or service person. This value is entered as the voltage constant.

The supply voltage should never exceed the limits shown in the Maximum Supply Voltage chart. Refer to Figure 38-1.

Low Voltage

The Low Voltage constant is used to set the low voltage limit. The low voltage limit factory default setting is 440 volts for use with a supply voltage of 480 VAC @ 60Hz. Recommended low voltage limits for other supply voltages are shown in the Recommended Low Voltage chart. Refer to Figure 38-2.

If the control panel voltmeter senses voltage below the low voltage limit, a built-in timer keeps the machine running for up to 15 seconds to prevent nuisance shutdowns due to voltage fluctuations.

If the low voltage condition still exists after 15 seconds, the machine will be shut down and the diagnostics screen will display a fault for machine power.

Nominal Supply Voltage	Maximum Supply Voltage
480 VAC @ 60Hz	505 VAC
415 VAC @ 50Hz	420 VAC
400 VAC @ 50Hz	420 VAC
380 VAC @ 50Hz	420 VAC
230 VAC @ 60Hz	253 VAC
220 VAC @ 50Hz	243 VAC
120 VAC @ 60Hz	132 VAC
110 VAC @ 50Hz	121 VAC

Figure 38-1 Maximum Supply Voltage

Nominal Supply Voltage	Recommended Low Voltage Setting
480 VAC @ 60Hz	440 VAC
415 VAC @ 50Hz	375 VAC
400 VAC @ 50Hz	365 VAC
380 VAC @ 50Hz	355 VAC
230 VAC @ 60Hz	220 VAC
220 VAC @ 50Hz	210 VAC
120 VAC @ 60Hz	105 VAC
110 VAC @ 50Hz	95 VAC

Figure 38-2 Recommended Low Voltage

CAUTION

- DO NOT SET LOW VOLTAGE LOWER THAN THE RECOMMENDED LOW VOLTAGE LIMIT.
- LOW VOLTAGE WILL DAMAGE THE DRIVE MOTORS AND OTHER ELECTRICAL COMPONENTS. CORRECT THE PROBLEM BEFORE RESUMING OPERATION

Estimated Drive Unit Speed Table

Use this table to estimate the Intermediate Drive Unit and End Drive Unit speed based on the drive unit motor output RPM, tire size, and machine voltage. Refer to Figure 38-3.

Estimated Drive Unit Speed																	
Drive Unit Motor Output RPM	Tire Sizes / Machine Voltage and Hertz																
	11.2 x 24				14.9 x 24				16.9 x 24				11.2 x 38				
	480 Volt 60Hz		380 Volt 50Hz		480 Volt 60Hz		380 Volt 50Hz		480 Volt 60Hz		380 Volt 50Hz		480 Volt 60Hz		380 Volt 50Hz		
	ft./min.	M/min.	ft./min.	M/min.	ft./min.	M/min.	ft./min.	M/min.	ft./min.	M/min.	ft./min.	M/min.	ft./min.	M/min.	ft./min.	M/min.	
29	5.90	1.80	4.91	1.50	6.54	1.99	5.45	1.66	6.98	2.13	5.81	1.77	8.06	2.45	6.71	2.04	
30	6.10	1.86	5.08	1.55	6.77	2.06	5.64	1.72	7.22	2.20	6.01	1.83	8.34	2.54	6.95	2.12	
34	6.95	2.12	5.79	1.76	7.40	2.25	6.16	1.88	8.16	2.48	6.80	2.07	9.45	2.88	7.87	2.40	
35	7.12	2.17	5.93	1.81	7.89	2.40	6.57	2.00	8.42	2.56	7.01	2.14	9.73	2.96	8.11	2.47	
37	7.53	2.29	6.27	1.91	8.53	2.60	7.11	2.16	8.90	2.71	7.41	2.26	10.28	3.13	8.56	2.61	
43	8.75	2.66	7.29	2.22	9.91	3.02	8.26	2.51	10.34	3.15	8.61	2.62	11.94	3.64	9.95	3.03	
56	11.39	3.47	9.49	2.89	12.63	3.85	10.52	3.20	13.48	4.10	11.23	3.42	15.56	4.74	12.96	3.95	
58	11.80	3.59	9.83	2.99	13.08	3.98	10.90	3.32	13.96	4.25	11.63	3.54	16.12	4.91	13.43	4.09	
68	13.84	4.21	11.53	3.51	15.34	4.67	12.78	3.89	16.36	4.98	13.63	4.15	18.90	5.76	15.74	4.79	
69	14.03	4.27	11.69	3.56	15.57	4.74	12.97	3.95	16.60	5.05	13.83	4.21	19.18	5.84	15.98	4.86	

GPS Angular Conversion Table

Use the GPS Angular Conversion table to convert the GPS angular degrees from minutes and seconds to decimal degrees when manually setting up the GPS coordinates in the Pro2 control panel. Refer to Figure 39-1.

Minutes and Seconds into Decimals of a Degree											
(Based on 1 second = 0.00027778 degrees)											
Minutes into Decimals of a Degree						Seconds into Decimals of a Degree					
Min.	Deg.	Min.	Deg.	Min.	Deg.	Sec.	Deg.	Sec.	Deg.	Sec.	Deg.
1	0.0167	21	0.3500	41	0.6833	1	0.0003	21	0.0058	41	0.0114
2	0.0333	22	0.3667	42	0.7000	2	0.0006	22	0.0061	42	0.0117
3	0.0500	23	0.3833	43	0.7167	3	0.0008	23	0.0064	43	0.0119
4	0.0667	24	0.4000	44	0.7333	4	0.0011	24	0.0067	44	0.0122
5	0.0833	25	0.4167	45	0.7500	5	0.0014	25	0.0069	45	0.0125
6	0.1000	26	0.4333	46	0.7667	6	0.0017	26	0.0072	46	0.0128
7	0.1167	27	0.4500	47	0.7833	7	0.0019	27	0.0075	47	0.0131
8	0.1333	28	0.4667	48	0.8000	8	0.0022	28	0.0078	48	0.0133
9	0.1500	29	0.4833	49	0.8167	9	0.0025	29	0.0081	49	0.0136
10	0.1667	30	0.5000	50	0.8333	10	0.0028	30	0.0083	50	0.0139
11	0.1833	31	0.5167	51	0.8500	11	0.0031	31	0.0086	51	0.0142
12	0.2000	32	0.5333	52	0.8667	12	0.0033	32	0.0089	52	0.0144
13	0.2167	33	0.5500	53	0.8833	13	0.0036	33	0.0092	53	0.0147
14	0.2333	34	0.5667	54	0.9000	14	0.0039	34	0.0094	54	0.0150
15	0.2500	35	0.5833	55	0.9167	15	0.0042	35	0.0097	55	0.0153
16	0.2667	36	0.6000	56	0.9333	16	0.0044	36	0.0100	56	0.0156
17	0.2833	37	0.6167	57	0.9500	17	0.0047	37	0.0103	57	0.0158
18	0.3000	38	0.6333	58	0.9667	18	0.0050	38	0.0106	58	0.0161
19	0.3167	39	0.6500	59	0.9833	19	0.0053	39	0.0108	59	0.0164
20	0.3333	40	0.6667	60	1.0000	20	0.0056	40	0.0111	60	0.0167

Figure 39-1 GPS Angular Conversion Table

Angular Degree Examples

An angular degree in degrees, minutes, seconds will look like the following examples:

- **10° 11' 37", reads as 10 degrees, 11 minutes, 37 seconds.**

(a) Convert minutes and seconds to a decimal degree value using the table in Figure 39-1.

11 minutes = 0.1833 degrees

37 seconds = 0.0103 degrees.

(b) Add all decimal degree values together.

10 degrees = 10.0000 degrees

11 minutes = 0.1833 degrees

37 seconds = 0.0103 degrees

10° 11' 37" = 10.1936 degrees

- **12° 5.245', read as 12 degrees, 5.245 minutes.**

(a) Convert decimals of a minute to decimal degrees using the table in 39-1 and multiply the decimal of a minute by 0.0167.

5 minutes = 0.0833 degrees

0.245 minutes =

$0.245 \times 0.0167 = 0.0041$ degrees

(b) Add all decimal degree values together.

12 degrees = 12.0000 degrees

5 minutes = 0.0833 degrees



0.245 minutes = 0.0041 degrees



12° 5.245' = 12.0874 degrees

Valley Select2 Control Panel



Operation



Run The Machine Wet (With Water)

1. ALWAYS make sure that vehicles, other equipment, livestock and persons are clear of the machine before operating.
2. Turn the control panel main disconnect switch to the ON position.
 - If the power is supplied by an engine driven generator, adjust the RPM of the generator until the voltmeter reads the correct Nominal Supply Voltage for the machine.
3. Press  to turn water ON.
4. Set the water application depth.
 - Use  or  to enter depth of water in inches and percent timer setting.

5. Press  or  to start the machine. Press  to Stop the machine.

Run The Machine Dry (Without Water)

1. ALWAYS make sure that vehicles, other equipment, livestock, and persons are clear of the machine before operating.
2. Turn the control panel main disconnect switch to the ON position.
 - If the power is supplied by an engine driven generator, adjust the RPM of the generator until the voltmeter reads the correct Nominal Supply Voltage for the machine.
3. Press  to turn water OFF.
4. Set the speed of travel.
 - Use  or  to enter percent timer setting.

5. Press  or  to start the machine. Press  to Stop the machine.

Stopping The Machine Emergency Stopping

To stop the machine in an emergency situation, shut off any one of the following:

- Main Service Disconnect Switch from public power to the control panel. See figure 41-1.
- Control Panel Main Disconnect Switch. See figure 41-1.
- Any Tower Box Disconnect Switch. See figure 41-1.

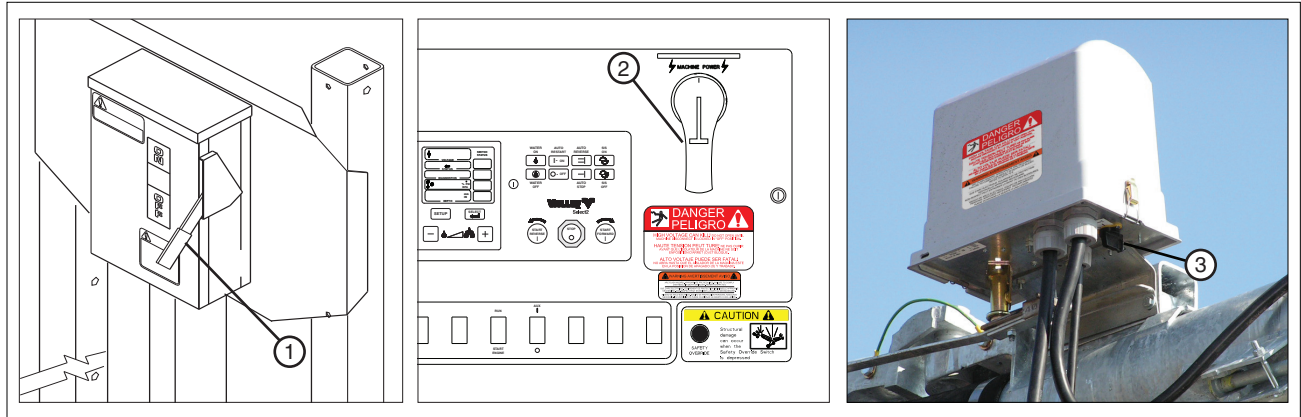

Figure 42-1 1. Main Service Disconnect Switch
2. Control Panel Main Disconnect Switch.
3. Tower Box Disconnect Switch..

Stopping Under Normal Conditions

1. Press the STOP button. See figure 41-2.
2. Turn the main disconnect switch to the OFF position. See figure 41-2.
3. Turn the pumping unit OFF (if not automatic).
4. If an engine generator set is utilized, place the Engine Run/Start switch to the Start position for the next start-up sequence.

⚠ WARNING

- **DO NOT SHUT THE MACHINE OFF BY SLOWLY IDLING DOWN THE ENGINE GENERATOR SET. THIS PRACTICE CAUSES LOW VOLTAGE AND WILL DAMAGE MACHINE COMPONENTS.**
- **ALWAYS STOP THE IRRIGATION MACHINE PRIOR TO SHUTTING DOWN THE ENGINE-GENERATOR SET.**

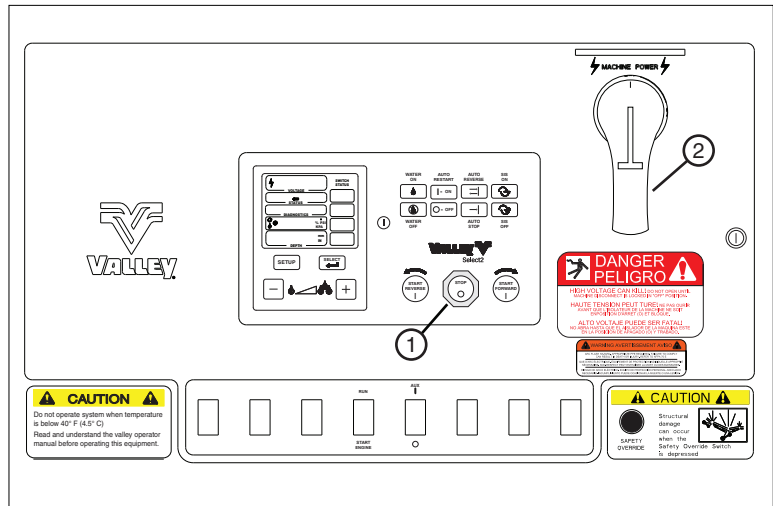

Figure 41-2 1. Stop button.
2. Main Disconnect Switch OFF.

Valley Select2 Control Panel

Diagnostics

Diagnostics Screen

The diagnostics section provides an overview of using the diagnostic features incorporated into the control panel. See figure 42-1. Diagnostics aid in identifying machine failures, troubleshooting, and correcting problems.

System Faults

System Faults are failures that shut the machine down. The fault symbols that can be indicated on the Diagnostics Screen are shown below along with a brief description. See Troubleshooting section for possible causes and corrective action.



Figure 42-1

Power Fault



A power fault is caused by an interruption of the machine's voltage source or low voltage less than the low voltage setting for more than 15 seconds.

Check the voltage screen to determine if the voltage is below the low voltage setting.

If voltage is below the low voltage setting, the machine will not restart.

If voltage is near the low voltage setting, then voltage fell below this setting and caused the machine to shut down.

DO NOT set low voltage setting lower than the recommended low voltage setting.

Low Pressure



A low pressure fault indicates that the water pressure fell below the low pressure setting for more than the startup and operating pressure delays.

If the pressure drops below the Low PSI after the startup pressure delay then the operating pressure delay takes over.

If the psi is not returned within the operating psi delay then the system will shut down indicating a Low Pressure Fault.

Equipment Safety



An equipment safety fault is caused by a break in the safety return circuit for longer than 3 seconds or longer than 1.5 seconds in eng/alt mode.

IMPORTANT: Call your local authorized Valley dealer for service on your machine. DO NOT attempt to service your own machine.

Command



The control panel symbol (not flashing) represents a commanded shut down.

This symbol would indicate that the machine was commanded to shut down due to one of the following situations:

1. The STOP button was pressed.
2. The machine was stopped due to the drive unit mounted auto reverse/stop option or F Pos or R Pos fault.
3. Pivot was stopped remotely.

IMPORTANT: If the control panel symbol flashes, this indicates a BBRAM Fault, Relay Com Fault, or both run lines are hot.

Stop In Slot



The stop in slot symbol indicates the machine was shut down due to the stop in slot feature.

The Valley Select2 panel allows the operator to start the machine at the stop in slot location with the stop in slot button activated. The stop in slot is automatically bypassed when starting the machine until the machine operates 2° away from the SIS position setting.

IMPORTANT: Call your local authorized Valley dealer for service on your machine. DO NOT attempt to service your own machine.

Error Codes

The following values can be viewed and reset within SETUP Group 6:

- Error codes E01-E14 and E18-E20
1. From the main screen, press and hold **SETUP** until Setup Group 6 is displayed or press **SETUP** six times.
 2. Setup GROUP 6 will be shown in the display screen. See figure 43-1.
 - Pressing **SELECT** advances the operator to the next value in the Setup Group. Any changes made will be saved.
 - Pressing **i** at any time within Setup Group will return the operator to the main screen. Any changes made will be saved.
 - Pressing **SETUP** at any time within the Setup Group will advance the operator to the next setup group. Any changes made will be saved.

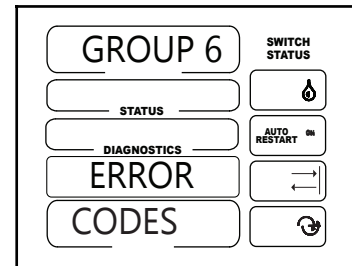

Figure 43-1

Viewing or Clearing An Error Code

To view an error code or clear an error code count, do the following:

1. Setup GROUP 6 ERROR CODES should be displayed.
2. Press **SELECT** to advance to the desired error code. The most recent event date and time will be displayed. See figure 44-2.
 - View the error code by pressing **SELECT**
 - Clear the error code count by pressing/holding **SELECT** until the count is cleared (Approximately 3 seconds).

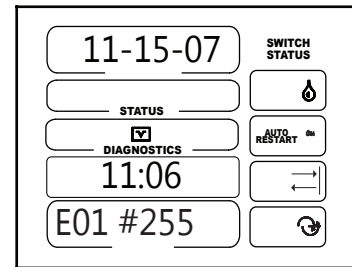

Figure 43-2

NOTE

- The date and time displayed is the most recent event of the error.
- The "#255" illustrated is the number of times the event occurred. The range is 0 - 255.

ERROR Software v2.00	DESCRIPTION (Descriptions are not shown on screen)
E01	BBRAM - CHECKSUM FAILED AT POWER UP.
E02	EEPROM - CHECKSUM FAILED AT POWER UP.
E03	UNIT RESETS - THIS IS LOGGED WHEN THE SOFTWARE RESETS.
E04	POWER DROP - POWER DROPPED BELOW LOW VOLTAGE LIMIT.
E05	SYSTEM SAFETY - POSSIBLE TOWER MISALIGNMENT, DRIVE UNIT MAY BE STUCK.
E06	PUMP SAFETY - PRESSURE TOO LOW AFTER PRESSURE DELAY.
E07	PRESSURE SENSOR - OUT OF RANGE HIGH, CHECK CONNECTION.
E08	PRESSURE SENSOR - OUT OF RANGE LOW, CHECK CONNECTION.
E09	PRESSURE SENSOR - PRESSURE HIGH WITH PUMP OFF, CHECK CONNECTION.
E10	PRESSURE SENSOR - MECHANICAL SWITCH COULD BE STUCK.
E11	RESOLVER - ANGLE JUMPING AROUND, LUBE J PIPE.
E12	E12 RESOLVER - OUT OF RANGE HIGH, CHECK FOR LOOSE OR SHORTED WIRES.
E13	KEYPAD - POSSIBLE KEY STUCK, CHECK KEYPAD CONNECTION.
E14	FWD/REV SENSE - POSSIBLE SHORT, CHECK WIRING.
E18	GPS COMMUNICATION ERROR, CHECK GPS COMMUNICATION AND POWER.
E19	GPS SIGNAL LOSS, CHECK FOR CLEAR PATH ABOVE ANTENNA. Position will flash when error occurs.
E20	DGPS SIGNAL LOSS, CHECK FOR CLEAR PATH ABOVE ANTENNA.
E23	PLC COMMUNICATIONS ERROR. (GPS v2 Only)
E25	GPS COORDINATES OUT OF RANGE, CHECK DISTANCE TO GPS OR FOR CROSSTALK.

Valley Select2 Control Panel

Troubleshooting

Use this Troubleshooting section with the machine owner's manual to diagnose and troubleshoot problems with the machine and/or control panel.

Always perform service or maintenance safely, use personal protection equipment when required, maintain a minimum working clearance around the control panel and other equipment, use fall protection when required, always use at least the minimal lockout/tagout procedure when maintaining or servicing the machine. For more information see the Safety section.



WARNING

- **TO REDUCE THE POSSIBILITY OF SEVERE INJURY OR DEATH:**
- **TROUBLESHOOTING OR REPAIRING ELECTRICAL PROBLEMS SHOULD ONLY BE PERFORMED BY A QUALIFIED VALLEY DEALER.**
- **ALWAYS CONTACT YOUR LOCAL VALLEY DEALER TO TROUBLESHOOT OR CORRECT ANY ELECTRICAL PROBLEMS ON OR ASSOCIATED WITH THE CONTROL PANEL OR MACHINE. NEVER ATTEMPT TO TROUBLESHOOT OR CORRECT ELECTRICAL PROBLEMS ON YOUR OWN.**
- **USE PERSONAL PROTECTION EQUIPMENT WHEN REQUIRED.**
- **MAINTAIN A MINIMUM WORKING DISTANCE AROUND THE CONTROL PANEL AND OTHER EQUIPMENT.**
- **USE FALL PROTECTION WHEN REQUIRED.**
- **BEFORE SERVICING OR PERFORMING MAINTENANCE ON THE MACHINE, ALWAYS SHUT OFF ALL ELECTRICAL POWER TO THE CONTROL PANEL AND MACHINE, THEN USE THE MINIMAL LOCKOUT/TAGOUT PROCEDURE ON THE SERVICE DISCONNECT AND CONTROL PANEL.**

Valley Select2 Control Panel

Troubleshooting

System Faults

Listed below are the possible system faults with the description, possible causes, whether the machine will shutdown if the error occurs, and the corrective action to take. See figure 45-1.











SYSTEM FAULT	DESCRIPTION WITH POSSIBLE CAUSES	SHUT DOWN	CORRECTIVE ACTION
 SYSTEM POWER FAULT	Voltage has fallen below the low voltage limit for more than 15 seconds or power was lost, while the machine was running.	YES	Check Low Voltage Limit for correct value. Contact your Valley dealer.
 SYSTEM SAFETY FAULT	Caused by a break in the safety return circuit for more than 3 seconds or more than 1.5 seconds if Eng Alt selected.	YES - if more than 3 seconds	Make sure a tower is NOT stuck. Check for flat tire on a tower. Check for wheel gearbox failure. Check End Of Field Stop for proper operation. Contact your Valley dealer.
 PRESSURE FAULT	The pressure fell below the low pressure limit, more than the operating pressure delay, or the Startup and Operating Pressure Delay is not a sufficient amount of time to build pressure in the machine after it is started.	YES - if more than the operating pressure delay	Make sure pump IS ON. Set Low Pressure Limit lower. Set Startup and Operating Pressure Delay for longer period of time. Contact your Valley dealer.
 COMMAND FAULT	The machine was intentionally commanded to stop by one of the following: 1) The stop key was pressed. 2) An auto stop condition occurred. 3) Remote controlled stop.	YES	Normal Operation - No Corrective Action Needed.
 STOP-IN-SLOT (SIS) FAULT	The machine was shut down by the Stop-In-Slot.	YES	Normal Operation - No Corrective Action Needed. If desired program a different Stop-in-slot location.
 BBRAM FAULT <small>Flashing</small>	Indicates that an attempt was made to start the machine when Error E01 was present.	YES	Contact your Valley dealer. Clear by viewing Diagnostics when BBRAM E01 is present.
 FWD/REV SENSE FAULT <small>Flashing</small>	Both the forward and reverse sense relays were on for more then 15 seconds while the system was running or waiting. Error 14 will also be present.	YES	Contact your Valley dealer. Fault cleared when the system attempts to run.
 RELAY COM FAULT <small>Flashing</small>	There is a hardware or software communication problem between the Select2 module and the electrical relay board within the control panel.	YES	Contact your Valley dealer.
 F POS OR R POS FAULT	Indicates the machine has gone out of bounds or the Forward Position or Reverse Position is being used, the resolver has problems or is disconnected, and the AR/AS is enabled.	YES	Check F Pos and R Pos boundaries. Correct resolver issues. Disable AR/AS. Contact your Valley dealer.
 GPS COM FAULT <small>Flashing</small>	While the system was running or waiting, all of the following must have occurred: 1) GPS is selected as a protocol. 2) GPS Loss Shutdown must be set to Standard or DGPS for this fault to occur. 3) The machine shutdown due to no communication with the GPS for a user specified time or default time of 20 minutes.	YES	Check the GPS connection, power supply, power line carrier and wiring. Contact your Valley dealer.
 GPS LOCK FAULT	While the system was running or waiting, all of the following must have occurred: 1) GPS is selected as a protocol. 2) GPS Loss Shutdown must be set to Standard or DGPS for this fault to occur. 3) The machine shut down due to GPS signal loss for a user specified time or default time of 20 minutes.	YES	Check for a clear path above the antenna. Contact your Valley dealer.

Figure 45-1

Valley Select2 Control Panel

Troubleshooting

Error Codes

Listed below are the possible error codes with the description, threshold for the error to occur, whether the machine will shutdown if the error occurs and possible causes or corrective action to take. See figures 46-1, 47-1 and 49-1.

ERROR	DESCRIPTION	THRESHOLD	SYSTEM FAULT SHUT DOWN	POSSIBLE CAUSES or CORRECTIVE ACTION	SHOWN ON SCREEN
E01	BBRAM - BATTERY BACKED RAM CHECKSUM FAILED AT POWER UP.		YES	Contact your Valley dealer.	YES
E02	EEPROM - CHECKSUM FAILED AT POWER UP.	One of the blocks failed.	YES	This error can occur when power is lost while entering constants. Data being entered may be lost. Try to Hard Reset Module. Contact your Valley dealer.	YES
E03	UNIT RESETS - THIS IS LOGGED WHEN THE SOFTWARE RESETS.	Every time the software is power cycled.	NO	Records every time the module is power cycled. Normal operation no corrective action.	NO
E04	POWER DROP - POWER DROPPED BELOW LOW VOLTAGE LIMIT.	If Running/Waiting and voltage drops below low voltage.	YES - after 15 seconds.	This error occurs when the voltage drops below the low voltage limit. Nuisance shutdowns can be caused by setting the Low Voltage Limit too high. Contact your Valley dealer.	YES
E05	SYSTEM SAFETY - POSSIBLE TOWER MISALIGNMENT, DRIVE UNIT MAY BE STUCK.	Safety lost while running.	YES - after 3 seconds.	This error occurs when safety circuit is open due to misaligned towers, guidance problems, over-watering timer timed out, or any other component in the safety circuit. Contact Your Valley Dealer.	YES
E06	PUMP SAFETY - PRESSURE TOO LOW AFTER PRESSURE DELAY.	Pressure with pump off.	YES - until started.	This error may occur when: The pressure delay time or the low pressure setting are not correct. The pump, pressure transducer, or pressure switch may have failed Low pressure set point too close to Operating Pressure. Contact your Valley dealer.	YES
E07	PRESSURE SENSOR - OUT OF RANGE HIGH, CHECK CONNECTION.	> 4.5 volts.	NO	This error occurs when the pressure transducer has failed. Contact your Valley dealer.	YES
E08	PRESSURE SENSOR - OUT OF RANGE LOW, CHECK CONNECTION.	< 0.5 volts.	NO	This error may occur when the pressure transducer has failed or is not installed. Contact your Valley dealer.	YES
E09	PRESSURE SENSOR - PRESSURE HIGH WITH PUMP OFF, CHECK CONNECTION.	Pump off for 5 min., and more then 7 PSI (0.5 bar)	NO	This error may occur when the pressure transducer has failed or water is still in riser pipe because a machine drain may be plugged. Re-calibrate pressure transducer. Contact your Valley dealer.	YES

Figure 46-1

Valley Select2 Control Panel

Troubleshooting

Error Codes (continued)

ERROR	DESCRIPTION	THRESHOLD	SYSTEM FAULT SHUT DOWN	POSSIBLE CAUSES or CORRECTIVE ACTION	SHOWN ON SCREEN
E10	PRESSURE SENSOR - MECHANICAL SWITCH COULD BE STUCK.	Pump off for 5 min, and switch still on.	NO	This error may occur if the pressure transducer or switch has failed or is stuck. Contact your Valley dealer.	YES
E11	RESOLVER - ANGLE JUMPING AROUND, LUBE J PIPE.	5° jump in 1 second (twice).	NO	This error may occur if: The pivot swivel is binding or sticking and requires lubrication. J-tube overtightened or seized. Pipe not secured to H-bracket. Collector ring loose. Contact your Valley dealer.	YES
E12	RESOLVER - OUT OF RANGE HIGH POSSIBLY DISCONNECTED.	X AND Y = 2.5 volts.	NO	This error may occur if the resolver wires are loose or shorted. Contact your Valley dealer.	YES
E13	KEYPAD - POSSIBLE KEY STUCK CHECK KEYPAD CONNECTION.	10 seconds.	NO	This error may occur if the key pad has failed or a key is stuck. Contact your Valley dealer.	YES
E14	FWD/REV SENSE - POSSIBLE SHORT, CHECK WIRING.	2 seconds.	YES - after 15 seconds.	When this error is detected, both the forward and reverse run lines are powered. The machine status will show running when AR/AS is OFF even though the motor contactor is disabled. The machine will stop if AR/AS is ON and Auto Stop is selected. If AR/AS is ON and Auto Reverse is selected, the machine will alternate between forward and reverse direction control. Since motor power is disabled until the direction has locked in, the machine will not move. Contact your Valley dealer.	YES
E18	GPS COMMUNICATION ERROR.	10 seconds.	YES, if Shut Down System is selected.	This error occurs when GPS is selected as a protocol and a transition occurs from communications to no communications for 10 seconds. Check GPS connection. When GPS option is powered by safety circuit a loss of power will cause this error.	NO, position will flash.
E19	GPS SIGNAL LOSS. Position of machine will flash when error occurs.	10 seconds.	YES, if Shut Down System is selected.	This error occurs when the signal from the GPS transitions from GPS Lock to GPS Unlock. Check for clear path above the antenna.	NO, position will flash.

Figure 47-1

Valley Select2 Control Panel

Troubleshooting

Error Codes (continued)

ERROR	DESCRIPTION	THRESHOLD	SYSTEM FAULT SHUT DOWN	POSSIBLE CAUSES or CORRECTIVE ACTION	SHOWN ON SCREEN
E20	DGPS SIGNAL LOSS.	10 seconds.	NO	This error occurs when the signal from the DGPS transitions from DGPS to Standard. Check for clear path above the antenna.	NO
E23	PLC COMMUNICATIONS ERROR. (GPS v2 Only)	3 Times in a Row.	NO	This error occurs when a PLC with GPS v2 does not reply to control panel messages 3 times in a row. Verify Correct PLC Channel and ID Settings.	YES
E25	GPS COORDINATES OUT OF RANGE, CHECK DISTANCE TO GPS OR FOR CROSSTALK.	When GPS Coordinates go Out of Range	YES, if Shut Down System is selected.	This error occurs when: The distance from the pivot to the GPS receiver is outside of the set length ± - Set correct distance to GPS. The pivot point coordinates are incorrect -set pivot point to correct coordinates. There is crosstalk from another GPS device on the same channel - Change GPS PLC to different channel to avoid crosstalk.	YES

Figure 48-1

Valley Select2 Control Panel

Troubleshooting

Troubleshooting List

Listed below and on the next page are various problems with the description, possible causes or corrective action to take. See figure 49-1 below and figure 50-1 on the next page.

PROBLEM	POSSIBLE CAUSE OR CORRECTIVE ACTION
RESOLVER POSITION IS NOT ACCURATE.	PIVOT POINT BINDING.
	J-TUBE PACKING OVERTIGHTENED OR SEIZED.
	PIPE NOT SECURED TO H-BRACKET.
	COLLECTOR RING LOOSE.
	DIRECTION OFFSET INCORRECT.
	POOR ELECTRICAL CONNECTION OR NOISE.
	CONTACT YOUR VALLEY DEALER.
PIVOT AUTO REVERSES RANDOMLY.	CONTACT YOUR VALLEY DEALER.
PIVOT AUTO STOPS RANDOMLY.	CONTACT YOUR VALLEY DEALER.
PIVOT BREAKS SAFETY AT BARRICADE.	BARRICADE TOO HIGH ON ACTUATOR ARM.
	AUTO REVERSE/AUTO STOP DISABLED.
	AUTO REVERSE/AUTO STOP BOX NOT ADJUSTED CORRECTLY.
	CONTACT YOUR VALLEY DEALER.
PRESSURE TRANSDUCER READING INCORRECT.	CHECK VALVE HOLDING WATER IN RISER.
	TRANSDUCER HAS ICE AGAINST SENSOR.
	TRANSDUCER PLUGGED.
	POOR ELECTRICAL CONNECTION OR NOISE.
	PRESSURE TUBE PLUGGED OR DAMAGED.
	CONTACT YOUR VALLEY DEALER.
NO DISPLAY.	CONTRAST ADJUSTED TOO LIGHT OR DARK.
	DISCONNECT SWITCH OFF.
	NO POWER TO PIVOT.
	CONTACT YOUR VALLEY DEALER.
END GUN DOES NOT SHUT OFF.	INCORRECT END GUN ENTRY.
	FILTER PLUGGED.
	DEFECTIVE END GUN HARDWARE.
	DIRECTION OFFSET INCORRECT; ARC TOO SMALL.
	CONTACT YOUR VALLEY DEALER.
END GUN DOES NOT TURN ON.	END GUN CONSTANTS NOT PROGRAMMED CORRECTLY.
	DEFECTIVE END GUN HARDWARE.
	CONTACT YOUR VALLEY DEALER.
SCREEN FLASHES V. X.XX (Version Number) .	ERRATIC INCOMING POWER.
	LOW VOLTAGE.
	CONTACT YOUR VALLEY DEALER.
DOES NOT STOP AT SIS.	SIS NOT TURNED ON.
	SIS POSITION HAS BEEN CHANGED.
	MACHINE MUST MOVE AT LEAST 2° AWAY FROM THE SIS POSITION BEFORE IT CAN BE STOPPED AGAIN BY SIS.
	CONTACT YOUR VALLEY DEALER.

Figure 49-1

Valley Select2 Control Panel

Troubleshooting

Troubleshooting List (continued)

PROBLEM	POSSIBLE CAUSE OR CORRECTIVE ACTION
BACKLIGHT (OPTIONAL) DOES NOT TURN ON.	CONTACT YOUR VALLEY DEALER.
BACKLIGHTING DOES NOT TURN OFF AFTER 1 MINUTE.	CONTACT YOUR VALLEY DEALER.
SCREEN DARK.	CONTRAST SET TOO HIGH OR LOW
	CONTACT YOUR VALLEY DEALER.
PIVOT WON'T AUTO RESTART.	RESTART CRITERIA HAS NOT BEEN MET.
	SYSTEM FAULT OTHER THAN POWER OR PRESSURE.
	CONTACT YOUR VALLEY DEALER.

Figure 50-1



Hard Reset

A Hard reset will reset the Electrically Erasable Programmable Read-Only Memory (EEPROM).

- Resets Current Status to factory settings.
- Restores all Constants to factory settings.
- Restores all Options to factory settings.
- Clears programs.





Executing A Hard Reset

To execute a hard reset, follow the steps below:

1. Record all options settings, constants settings, and programs that will need to be re-entered after the hard reset.
2. Turn the control panel disconnect to OFF.
3. While turning the control panel disconnect ON press and hold  and  simultaneously until the Reset screen is displayed. See figure 51-1.
4. Press  to reset the panel to the factory defaults. See figure 51-2.
 - If a selection is not made within 60 seconds, the reset will be skipped.

Contrast Control

To adjust the contrast of the display, follow the steps below:

1. Press  and  simultaneously during power up of the panel.
2. The contrast display will be displayed. The default is 35%. See figure 51-3.
3. Adjust the contrast by pressing  or .
4. Press  to go to the main screen. If no buttons are pressed within 60 seconds, the main screen will appear.

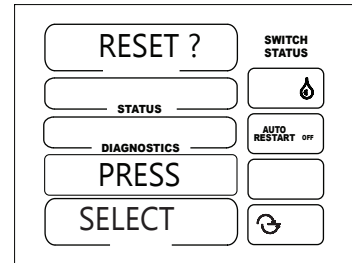

Figure 51-1

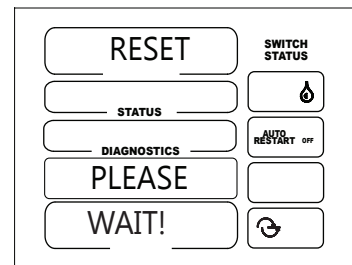

Figure 51-2

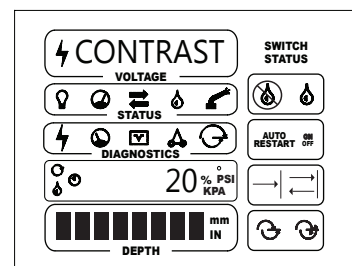
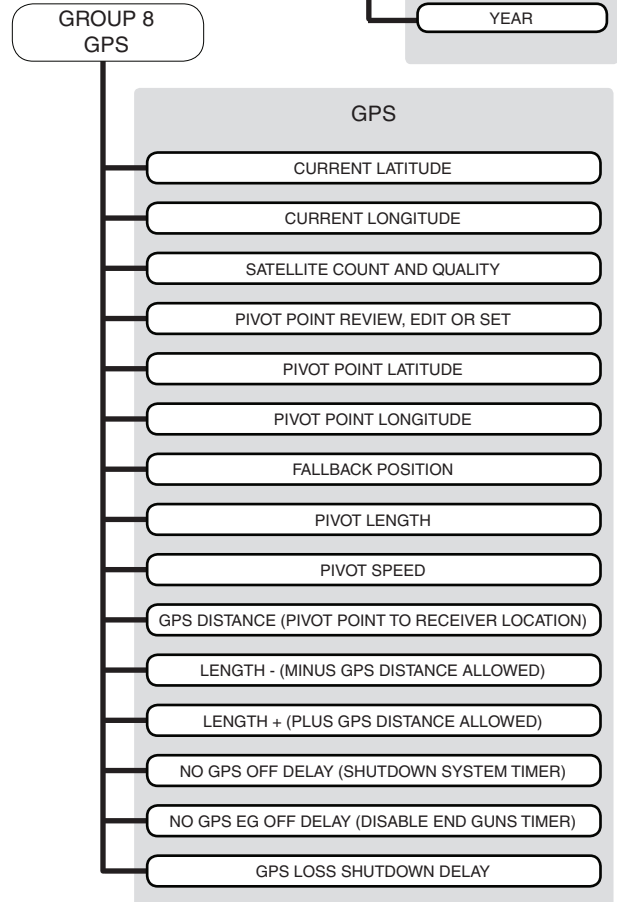
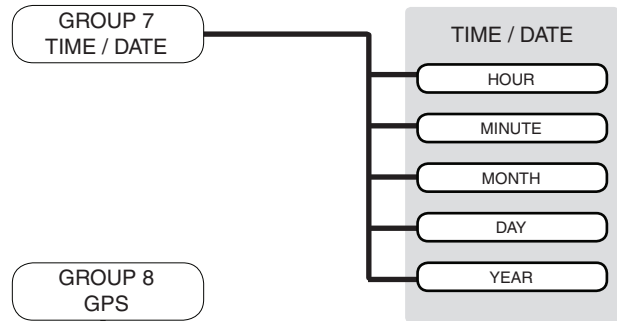
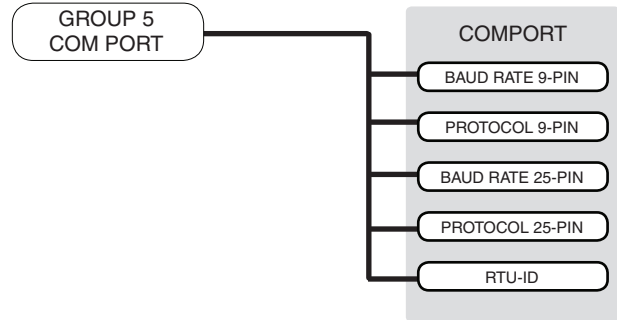
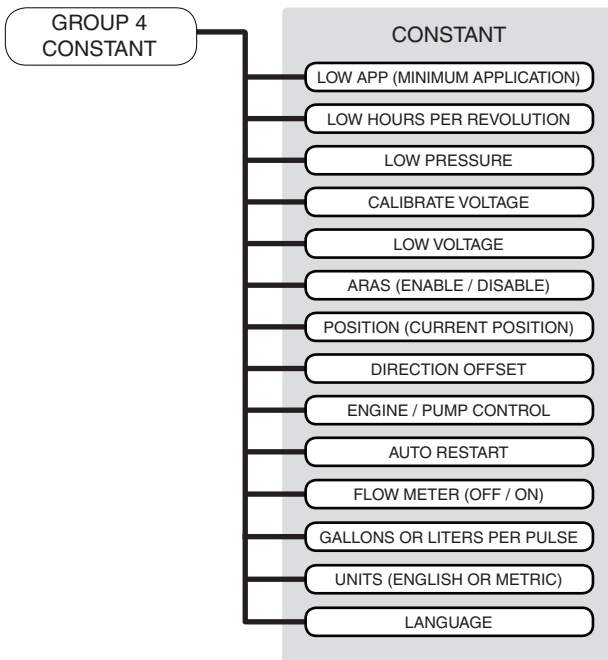
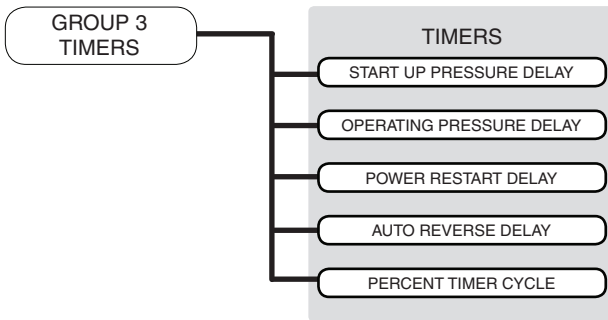
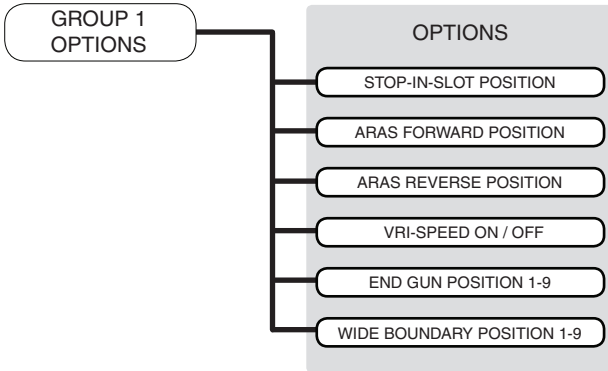

Figure 51-3

Valley Select2 Control Panel

Advanced Feature Guide

Shown below are the Advanced Features associated with each Select2 Setup Group.



Valley Select2 Control Panel

Advanced Feature Guide

Valley Select2 Control Panel

Appendix

Setup Record

SETUP GROUP 1 - OPTIONS

Stop in Slot _____ degrees
Forward Position Left Angle _____ degrees
Reverse Position Right Angle _____ degrees
VRI-S States Off, 1, 2, 3, 4, 5 _____

END GUN SETTINGS

	ON (left angle)	OFF (right angle)
ENDG-1	_____	_____
ENDG-2	_____	_____
ENDG-3	_____	_____
ENDG-4	_____	_____
ENDG-5	_____	_____
ENDG-6	_____	_____
ENDG-7	_____	_____
ENDG-8	_____	_____
ENDG-9	_____	_____

WIDE BOUNDARY SETTINGS

	ON (left angle)	OFF (right angle)
WDBD-1	_____	_____
WDBD-2	_____	_____
WDBD-3	_____	_____
WDBD-4	_____	_____
WDBD-5	_____	_____
WDBD-6	_____	_____
WDBD-7	_____	_____
WDBD-8	_____	_____
WDBD-9	_____	_____

SETUP GROUP 3 - TIMERS

Startup Pressure Delay	_____ seconds	Auto Reverse/Stop Delay	_____ seconds
Operating Pressure Delay	_____ seconds	Percent Timer Cycle	_____ seconds
Power / Pressure Restart Delay	_____ seconds		

SETUP GROUP 4 - CONSTANTS

Minimum Application	_____ inches (mm)	Direction Offset	_____ degrees
Low Hours/Revolution	_____ hours	Engine/Pump Control	_____ pump/engine/alt engine
Low Pressure	_____ psi (KPa)	Auto Restart	_____ both/pressure/power
Voltage Calibration	_____ volts	Flow Meter	_____ off or on
Low Voltage Setting	_____ volts	Gallons or Liters Per Pulse	_____
Auto Reverse/Stop	_____ off or on	Units	_____ inches (mm)
Current Position	_____ degrees	Language	_____

SETUP GROUP 5 - COMMUNICATIONS

Baud 9-Pin	_____	Protocol 25-Pin	_____
Protocol 9-Pin	_____	RTU ID	_____
Baud 25-Pin	_____		

SETUP GROUP 8 - GPS

Current Latitude	_____	Pivot Speed	_____
Current Longitude	_____	GPS Distance	_____
Satellite Count and Quality	_____	GPS Distance Length -	_____
Pivot Point Review, Set, Edit	_____	GPS Distance Length +	_____
Pivot Point Latitude	_____	Shutdown System Timer	_____
Pivot Point Longitude	_____	Disable End guns Timer	_____
Fallback Position	_____	GPS Loss Shutdown	_____
Pivot Length	_____		

Setup Record _____

SETUP GROUP 1 - OPTIONS

Stop in Slot _____ degrees
 Forward Position Left Angle _____ degrees
 Reverse Position Right Angle _____ degrees
 VRI-S States Off, 1, 2, 3, 4, 5 _____

END GUN SETTINGS

	ON (left angle)	OFF (right angle)
ENDG-1	_____	_____
ENDG-2	_____	_____
ENDG-3	_____	_____
ENDG-4	_____	_____
ENDG-5	_____	_____
ENDG-6	_____	_____
ENDG-7	_____	_____
ENDG-8	_____	_____
ENDG-9	_____	_____

WIDE BOUNDARY SETTINGS

	ON (left angle)	OFF (right angle)
WDBD-1	_____	_____
WDBD-2	_____	_____
WDBD-3	_____	_____
WDBD-4	_____	_____
WDBD-5	_____	_____
WDBD-6	_____	_____
WDBD-7	_____	_____
WDBD-8	_____	_____
WDBD-9	_____	_____

SETUP GROUP 3 - TIMERS

Startup Pressure Delay _____ seconds	Auto Reverse/Stop Delay _____ seconds
Operating Pressure Delay _____ seconds	Percent Timer Cycle _____ seconds
Power / Pressure Restart Delay _____ seconds	

SETUP GROUP 4 - CONSTANTS

Minimum Application _____ inches(mm)	Direction Offset _____ degrees
Low Hours/Revolution _____ hours	Engine/Pump Control _____ pump/engine/alt engine
Low Pressure _____ psi (KPa)	Auto Restart _____ both/pressure/power
Voltage Calibration _____ volts	Flow Meter _____ off or on
Low Voltage Setting _____ volts	Gallons or Liters Per Pulse _____
Auto Reverse/Stop _____ off or on	Units _____ inches (mm)
Current Position _____ degrees	Language _____

SETUP GROUP 5 - COMMUNICATIONS

Baud 9-Pin _____	Protocol 25-Pin _____
Protocol 9-Pin _____	RTU ID _____
Baud 25-Pin _____	

SETUP GROUP 8 - GPS

Current Latitude _____	Pivot Speed _____
Current Longitude _____	GPS Distance _____
Satellite Count and Quality _____	GPS Distance Length - _____
Pivot Point Review, Set, Edit _____	GPS Distance Length + _____
Pivot Point Latitude _____	Shutdown System Timer _____
Pivot Point Longitude _____	Disable End guns Timer _____
Fallback Position _____	GPS Loss Shutdown _____
Pivot Length _____	

Valley Select2 Control Panel

Appendix

Program Design Form

Each program is a defined sector in the field. Up to nine programs can be written.

1. Make a sketch of the field to identify what the machine needs to do.
2. For each program/sector determine the following:
 - a) Left Angle of sector (Start of sector)
 - b) Direction of travel (Forward, Reverse or Both)
 - c) Commands
(Water On and Depth of Application or Water Off and Percent Timer value)
 - d) Right Angle of sector (End of sector)

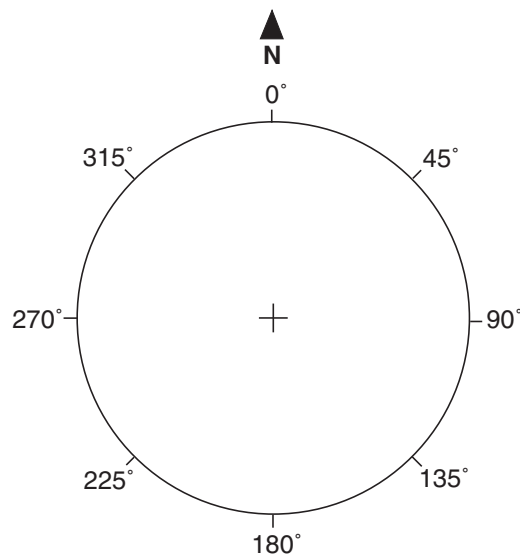
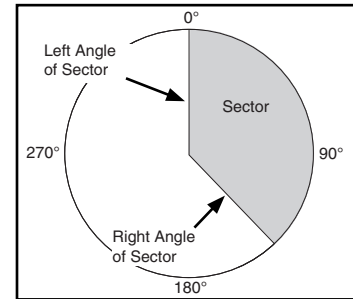

Program # Sector #	Conditions		Commands			Condition
	Start or ON Left Angle (degrees)	Direction	Water ON?	Water OFF?	Depth of Water (inches/mm) or Percentage	Stop or OFF Right Angle (degrees)
1						
2						
3						
4						
5						
6						
7						
8						
9						

Program Design Form

Each program is a defined sector in the field. Up to nine programs can be written.

1. Make a sketch of the field to identify what the machine needs to do.
2. For each program/sector determine the following:
 - a) Left Angle of sector (Start of sector)
 - b) Direction of travel (Forward, Reverse or Both)
 - c) Commands
(Water On and Depth of Application or Water Off and Percent Timer value)
 - d) Right Angle of sector (End of sector)

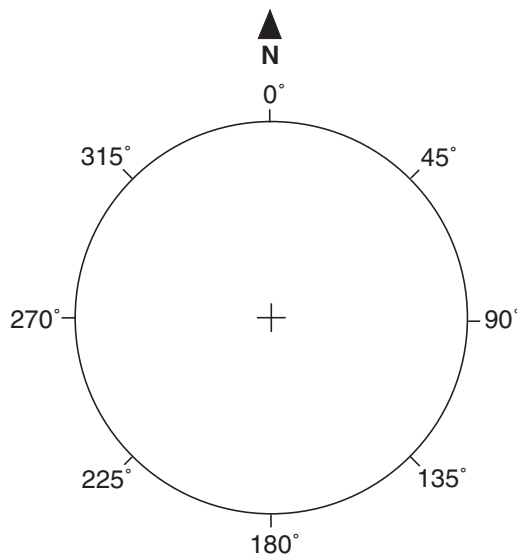
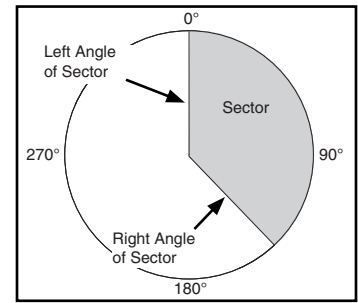

Program # Sector #	Conditions		Commands			Condition
	Start or ON Left Angle (degrees)	Direction	Water ON?	Water OFF?	Depth of Water (inches/mm) or Percentage	Stop or OFF Right Angle (degrees)
1						
2						
3						
4						
5						
6						
7						
8						
9						