



**Valley TouchPro
Control Panel
Advanced Features Manual
For
Software Version 9.02
0999415_0**



Table of Contents

About This Manual	8
Ancillary Equipment Warranty	8
Overview.....	9
Main Screen.....	9
System.....	11
System Screen.....	11
Control Tab.....	11
Flow/Hours.....	14
Total Flow Reading.....	14
Flow Meter Reading.....	14
Flow Multiplier.....	14
Total Hours.....	14
Wet Hours.....	14
Setting Total Hours or Wet Hours.....	14
Auxiliary.....	15
Auxiliary Relays.....	15
Using AUX1 or AUX2.....	15
Modules.....	16
Controlling Modules.....	16
Reviewing Modules.....	16
Setup.....	17
Setup Screen.....	17
Main Screen Setup.....	18
Field.....	18
Pivot Name.....	18
Pivot Road.....	18
Pivot Circle Constants.....	18
Status.....	19
Control.....	20
Constants.....	21
Constants.....	21
Minimum Application (Min/App).....	21
Hours Per Revolution (Hours/Rev).....	21
% Cycle Time.....	22
Auto Reverse Auto Stop Delay (ARAS Delay).....	22
Cruise Settings.....	23
Max % Change Of Speed.....	23
Field Size In Degrees.....	23
Resolution.....	23
Low Voltage.....	24
Voltage Calibration.....	25
Pump.....	26
Pump Type.....	26
AutoRestart Via: (Auto Restart).....	26
Low Pressure.....	28
Startup Pressure Delay.....	28
Operating Pressure Delay.....	28
Pressure Sensor.....	29
Calibrate Pressure Sensor.....	30
Position.....	31
Resolver Direction Offset.....	32
Calculating Direction Offset.....	33
Current Position.....	36
Pivot Point GPS.....	36
Satellite Lock.....	36
Satellite Count.....	36
Length to GPS.....	37
GPS Signal Loss.....	37

Table of Contents

Watering Timer	39
% Overwater Shutdown	39
% Underwater Error	39
Watering Timer Status	40
Communications Port.....	41
Comm. Port Tab.....	41
Tx Test (Transmit) Button	41
RTU ID	41
Hardware Flow Control	43
Key Wait.....	43
High Speed (High Speed Key Wait)	43
PLC Tab.....	44
GPS V2.....	44
TPMS Tire Pressure.....	44
PLC Tab.....	45
VRI-Zone	45
TPMS Water Pressure.....	45
PLC Wide Boundary	45
Options	47
Options Screen	47
Variable Rate Irrigation (VRI)	48
VRI Speed Control	48
VRI-S On/Off	48
View Prescription	49
Add Sector.....	50
Position Values.....	51
VRI-Zone Control	52
VRI-Z Map.....	52
VRI-Zone ON/OFF.....	52
VRI-Zone Speed Control ON/OFF.....	52
Irrigation Prescription.....	53
View Prescription	54
Prescription Upload Methods	55
Add Sector.....	56
VRI-Z Constants.....	57
System Shutdown.....	57
Position Values.....	57
Maximum Pressure.....	57
Valve Resync	57
Minimum Flow Rate	58
Sprinkler Banks	58
Minimum Cycle Time	58
VRI-Z Diagnostics	59
Turn Off One Valve.....	59
Resync Valves	59
VRI Button	59
VRI-Zone Overview	60
VRI Tower Box	60
Water Filter	60
Sprinkler Valve	60
Data Port	61
Stand Pipe Option	61

Table of Contents

Tire Pressure Monitor System (TPMS)	62
TPMS Data Tab	62
TPMS Constants Tab	62
Shutdown Pressure	62
Warning Pressure	63
Nominal Pressure	63
Sensor Setup	63
TPMS Diag Tab	64
TPMS Water Tab	65
TPMS Water Data	65
TPMS Water Constants	65
TPMS Water Diagnostics	65
Weather	66
Current Weather	66
Wind Speed	66
Wind Shutdown	66
Temperature	67
Temperature Shutdown	67
Rain	68
Rain Measurement	68
Rain Shutdown On/Off	68
Rain History	68
Weather Constants	69
Temperature Coefficient	69
Temperature Offset	69
Rain Window (days)	69
Rain Coefficient	69
End Gun	70
Pivot End Gun	70
End Gun Enable/Disable	70
Wide Boundary Enable/Disable	70
PLC Wide Boundary 2 Enable/Disable	70
PLC Wide Boundary 3 Enable/Disable	70
End Gun Sequences	71
Setting Pivot End Gun Sequence	72
Wide Boundary	73
Wide Boundary On/Off Sequences	73
Setting Wide Boundary Sequences	74
Data	75
Flow/Wind/Temp	75
Total Flow	76
Flow Meter	76
Flow Multiplier	76
Wind Speed	77
Wind Shutdown	77
Temperature	78
Temperature Shutdown	78
Pulse	79
Review and Edit Counter Readings	79
A/D - Analog to Digital Voltages	80
Reviewing A/D	80
Modules	81
Controlling Modules	81
Reviewing Modules	81
Notice (Event Callout)	83
Event Notification	84
Enabling or Disabling Events	84
Shutdown Events	84
Warning Events	85
Status Change Events	86
Remote Lockout	87

Table of Contents

Diagnostics	89
Diagnostics Screen	89
Faults	90
System Faults	90
Error Codes	90
Firmware Info	90
Advanced	90
Review History Standard	92
Review History Advanced	92
Sector Programming	93
Program Screen	93
Sector Programming	94
Sector Program Functions	94
Available Commands	94
Using Run	95
Sample Sector Program Design Form	96
Write a New Program	97
Reviewing or Editing Sector Programs	98
Using Delete Stored	98
Using Stop Running	98
Sector Program Examples	99
Designing Sector Programs	99
Sample Sector Program Design Form	99
Using the STOP Command	100
Using the Depth and Percent Commands	102
Using the End Gun and VRI Enable/Disable Commands	104
Using the Percent-of-Percent or Percent-of-Depth Command	106
Step Programming	109
Program Screen	109
Step Programs	110
Step Program Functions	110
Programming Conditions	110
Available Commands	110
Stored Program	110
Other Programming Conditions	111
Analog	111
Module	111
Pulse	112
Count	112
Wind	112
Temperature	112
Rain	112
Run Program Command	113
Start at a Step	114
Sample Step Program Design Form	115
Write a New Program	116
Using Review	117
Using Edit	118
Using Delete Stored	119
Step Program Examples	121
Designing Step Programs	121
Sample Step Program Design Form	121
Example 1. Program by Date, Time and Position	122
Example 2. Program by Day and Time	125
Example 3. Program by Date/Time and Position with SIS On	128
Example 4. Program by Position and Delay	130

Introduction

Example 5. Program by Position, Direction, and Delay	134
Example 6. Program by Pressure.....	137
Example 7. Program by Position, Module, and Delay	139
Example 8. Program with Percent-of-Percent Timer or Percent-of-Depth	143
Example 9. Program with Enable/Disable End Guns	144
Example 10. Program with Enable/Disable Cruise Control	145
Example 11. Program with VRI ON/OFF	146
Example 12. Program for a Logging Event.....	148
Example 13. Using the Run Program Command	149
Repeating Irrigation Cycles.....	152
Example 1. Continuous Auto Reverse Cycles	152
Example 2. Continuous Wet Area Water Off Cycles	155
Example 3. Using Run Program Command	157
Scheduled Irrigation Cycles	162
Example 1. Time Delay with Run Program Command	162
START\$ Program Examples.....	168
Delayed Start - Recommended.....	168
Immediate Start - Not Recommended.....	168
STOP\$ Program Example	169
Immediate Stop	169
CYCLE\$ Program Examples - Repeating Cycles	170
Example 1. Using CYCLE\$ Program.....	170
Executing CYCLE\$.....	171
Option 1 - Execute CYCLE\$ Immediately	171
Option 2 - Execute CYCLE\$ By Time	172
Example 1. Seven Days a Week	173
Example 2. Selected Days with Stop before Start	174
Example 3. Selected Days with Start before Stop	175
Example 4. Daily OPS Cycle - Interval in Days	176
Setup Cycle Interval.....	176
Write CYCLE\$ Program.....	177
Appendix: Programming Design Forms.....	179
Design Forms.....	179
Step Programming Design Form.....	180
Sector Programming Design Form.....	181

Introduction

About This Manual

Information contained in this manual applies to all Valley TouchPro Control Panels with the following software versions:

- TouchPro Module v9.02
- FlexBox v1.02 P1.9

Sections related to safety, pivot hardware, maintenance, towing, troubleshooting, and winterization are covered in the appropriate Valley Pivot Owners Manuals.

You, as the owner/operator, should familiarize yourself with the capabilities of the system in order to obtain optimum system performance. It should be remembered that the sprinkler will perform according to your knowledge of the equipment, soil and water relationships and equipment application concepts.

Specifications, descriptions and illustrative material contained herein were as accurate as known at the time this publication was approved for printing.

Valmont Industries Inc. reserves the right to change specification or design without incurring obligation. Specifications are applicable to machines sold in the United States and may vary outside the United States.

Additional information is contained within the Valley TouchPro Control Panel Owner's Manual, Part Number 0999006 (English).

Ancillary Equipment Warranty

The owner is responsible for warranty registration of all ancillary equipment such as engines, pumps and generators with its respective manufacturer.

Main Screen

The Main Screen is where you begin operating your irrigation machine, and where you learn its current status. Control buttons, and the state of each, are located on the left side of the screen. Menu buttons are on the right. The center contains information about the machine's current status and other selected details. See Figure 9-1, the default Main screen.

This manual describes all of the features controlled through the use of the menu buttons on the Main screen, with the exception of Diagnostics which is covered in the TouchPro Owner's Manual.

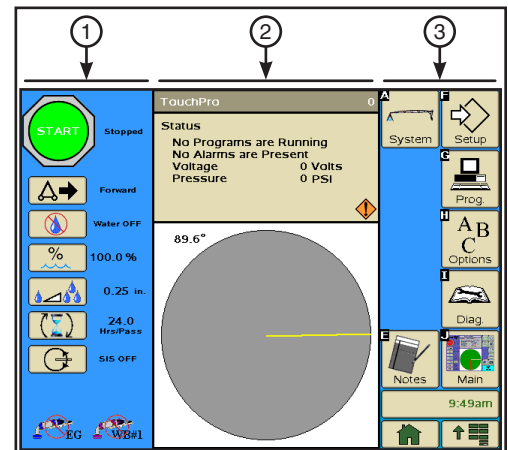

Figure 9-1 1. Controls and their States
2. Machine Statuses
3. Menu Buttons

Overview

System Screen

Push the **System** button on the Main screen to display the System screen. The user can change settings or view information from the System screen at any time. Refer to Figure 11-1.

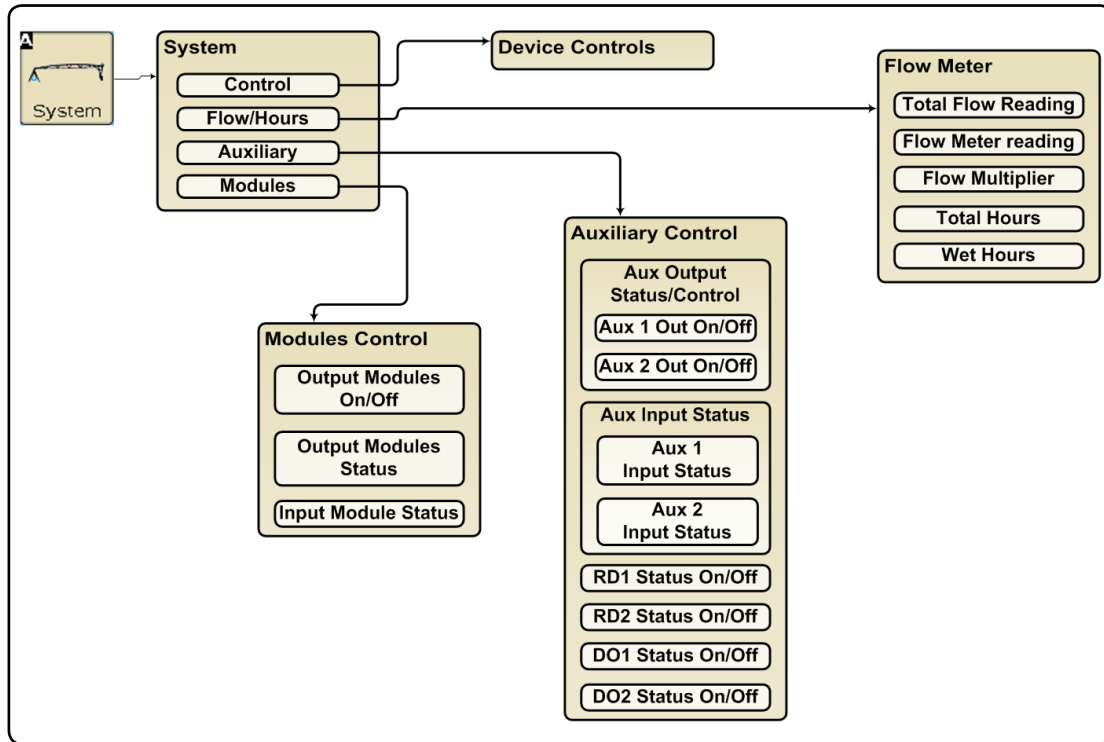

Figure 11-1

Control Tab

Push **System** and **Control** to view the Controls screen. Refer to Figure 11-2.

Pushing **Control** displays the control buttons, selected on the Main Screen Setup screen to appear on the Main screen, plus the control buttons for Stop-In-Slot (SIS), Auto Restart, ARAS, Aux 1, and Aux 2. Although these five control buttons can be selected to appear on the Main screen, accessing them here frees up room on the Main screen for additional control buttons.

The control buttons shown in Figure 11-2 are the factory default settings.

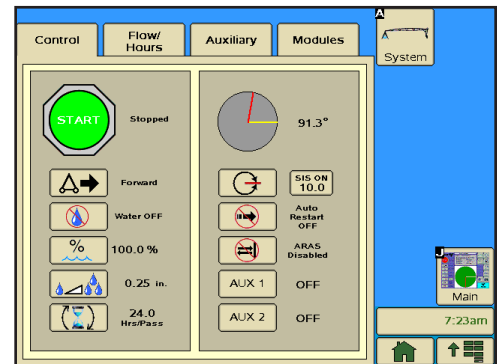

Figure 11-2 Control Screen

System

Control Tab (continued)

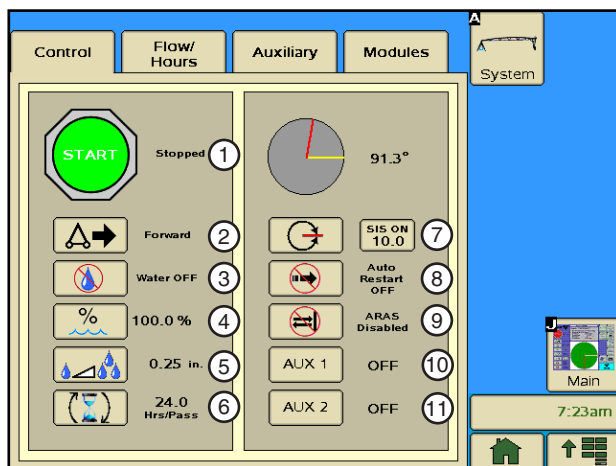



Figure 12-1 Control Screen

Figure 12-1 above displays the default buttons described below. The buttons will vary depending on the settings on the Main Screen Setup screen.



Start/Stop - Item 1

- The machine is currently stopped. Push the **START** button to start the machine, assuming safety circuits are operating correctly. Push the **STOP** button to halt machine movement, shut the pump off, and close the water valve.
- The machine has a time delay that prevents it from restarting when you press the **Start** key within five seconds after stopping it.

Forward/Reverse - Item 2

Machine movement is currently in the forward (clockwise) direction . Push to command movement in the reverse (counter-clockwise) direction .

Water ON/OFF - Item 3

- The pump and/or close water valve are currently off . Push to command the pump to turn on and/or the valve to open when the machine starts. A pre-programmed pressure switch delay is automatically recalled to allow sufficient time for pressure to build up in the machine.
- The pump and/or close water valve are currently on . Push to turn them off.



Percent Timer - Item 4

Press  to set the desired percent timer by entering the value on the numeric keypad. The value is then displayed next to the button. Refer to the Constants section of the Setup chapter for more information.

Depth - Item 5



Press  to set the desired water application depths in inches or millimeters, depending on the selected unit of measure, by entering the value on the numeric keypad. The value is then displayed next to the button. Refer to Minimum Application in the Constants section of the Setup chapter for more information.

Hours per Pass - Item 6



Press  to set the number of hours to complete one pass of a part circle based on the percent timer setting. The button changes to . Press the **Hrs/Pass** button  to enter the number on the numeric keypad. If Cruise Control is being used on a part circle, you must specify the Hours per Pass number.

Control Tab (continued)



Stop-In-Slot ON/OFF Button - Item 7

The stop-in-slot feature is currently on. This will stop the machine at a preset location in the field that you selected, such as the pivot road. Push  to turn this feature off. Push  to turn this feature on. Push the SIS ON button  to set the stop-in-slot location in the field in degrees.

Auto Restart ON/OFF Button - Item 8

The automatic restart feature is currently turned off. Push  to turn this feature on. Push  to turn the automatic restart feature off. Refer to Auto Restart in the Constants section of the Setup chapter for more information.

AR/AS Disable Button - Item 9

The Auto Reverse/Auto Stop (AR/AS) feature is currently disabled. Push  to have the machine Auto Stop. Push  to have the machine Auto Reverse. Push  to disable the Auto Reverse/Auto Stop feature. Refer to Auto Reverse Auto Stop Delay in the Constants section of the Setup chapter for more information.

AUX 1 and 2 ON/OFF - Items 10 and 11

Press AUX1 to turn the Auxiliary 1 relay ON (closed) or OFF (open). Press AUX2 to turn the Auxiliary 2 relay ON (closed) or OFF (open). When a relay is ON, it can control a contactor, solenoid, or other device.

System

Flow/Hours

Pushing the **Flow/Hours** tab displays the Total Flow reading, Flow Meter reading, Flow Multiplier, Total Hours, and Wet Hours.

Push **System, Flow/Hours** to view the Flow Meter screen. Refer to Figure 14-1.

Total Flow Reading

The total flow volume and rate of flow are displayed when the flow meter option is installed. Total flow is displayed in millions of gallons, or cubic meters.

Flow Meter Reading

The flow meter rate of flow is displayed in either gallons per minute (GPM) or liters per second (LPS), depending on the unit of measurement.

Flow Multiplier

The flow multiplier calibrates the control panel with the optional flow meter. Flow multiplier constants (pulse multiplier values) are usually provided by the flow meter manufacturer. The table below lists multiplier values for Valmont-supplied flow meters. To set the flow multiplier, refer to the Options section in this manual.

Pipe Diameter (inches)	Gallons per Pulse Typical Values	Liters per Pulse	Max. GPM/RPM	Max. LPS/RPM
6	0.6250	2.366	1300/2080	82.02/2080
6-5/8	0.7407	2.804	1300/1755	82.02/1755
8	1.2500	4.732	2500/2000	157.72/2000
8-5/8	1.3514	5.116	2500/1850	157.82/1850
10	1.9231	7.280	3000/1560	189.27/1560

Total Hours

Total Hours displays the cumulative hours of both wet and dry operation. Total hours can be changed by the operator, but only an increase in total hours is accepted.

Wet Hours

Wet Hours displays only the hours that the machine was operated with water, or wet. Wet Hours can be changed by the operator. An increase or decrease is accepted.

Setting Total Hours or Wet Hours

To set **Total Hours** or **Wet Hours**, follow these steps. Refer to Figure 14-1.

1. Push **System, Flow/Hours** to display the Flow/Hours screen.
2. Select the **Total Hours** field or **Wet Hours** field for the Total hours or Wet Hours screen.
3. Enter the number of hours on the numeric keypad.
 - Total Hours can only be increased. Decimal values are not allowed.
 - Hours Wet can be increased or decreased. Decimal values are not allowed.
4. Push the **Enter** button to retain the value.

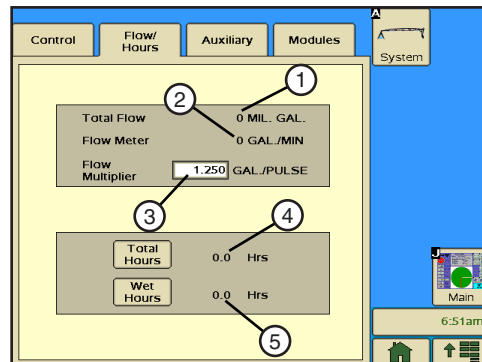

Figure 14-1 1. Total Flow 4. Total Hours
2. Flow Meter 5. Wet Hours
3. Flow Multiplier

Auxiliary

The Auxiliary screen provides auxiliary output control, the status of the Auxiliary Inputs, and control of the RD1, RD2, DO1, and DO2 relays. Refer to Figure 15-1.

Auxiliary Relays

Use AUX1 to turn the Auxiliary 1 relay ON (closed) or OFF (open). Use AUX2 to turn the Auxiliary 2 relay ON (closed) or OFF (open). When a relay is ON, it can control a contactor, solenoid, or other device.

Using AUX1 or AUX2

To turn either the Aux 1 or Aux 2 Output On or Off, do the following.

1. Push **System, Auxiliary** to display the Auxiliary screen. Refer to Figure 15-1.
2. Push **On or Off** for the chosen auxiliary output.

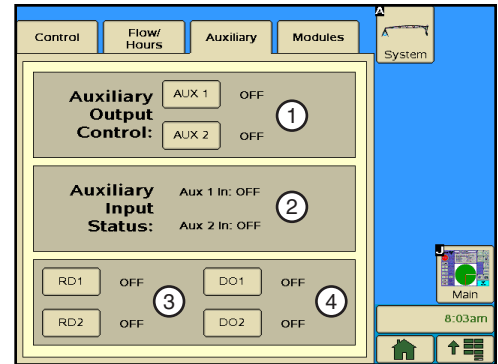

Figure 15-1 1. Auxiliary Output Control
2. Auxiliary Input Status
3. RD1&2 Control
4. DO1&2 Control

⚠ CAUTION

- AUXILIARY RELAYS ARE INTENDED FOR IRRIGATION EQUIPMENT ONLY. OTHER EXTERNAL USES MAY CAUSE INTERFERENCE WITH, OR EXCESSIVE LOAD ON THE TRANSFORMER. CONSULT WITH YOUR VALLEY DEALER BEFORE USING AUXILIARY RELAYS.
- IF AUXILIARY RELAYS #1 OR #2 ARE USED TO CONTROL AN INJECTOR PUMP, THE SCHEMATIC FOR THE CONTROL PANEL MUST BE FOLLOWED WHEN WIRING. THIS ENSURES OPERATION OF THE INJECTOR PUMP ONLY WITH SUFFICIENT WATER PRESSURE.

System

Modules

The Modules screen is used to review the condition of, and control, all input and output relays used to monitor and control the machine. Refer to Figure 16-1.

Module is another name for a relay. The machine is controlled by a series of relays located in the control panel. Each relay is either closed (ON) or open (OFF) as the machine is operating.

Controlling Modules

You can control an individual relay in the control panel from the Modules screen by selecting it from the **Output Modules** drop-down menu and pushing the **ON** button or the **OFF** button. Figure 16-2 contains the list of modules that can be controlled from this screen.

Output Module #	Relay
0	Safety Out
1	Percent Timer
2	End Gun
3	Wide Boundary
4	Pump Safety
5	Alarm
6	Auxiliary 1
7	Auxiliary 2
8	Contactora Enable
9	Direction
10	Digital Output 3
11	Digital Output 2
12	Digital Output 1
13	Relay Driver Output 1
14	Relay Driver Output 2

Figure 16-2 Output Control Modules

Reviewing Modules

You can review the status of an individual module in the control panel by selecting it from the **Input Modules** drop-down menu. The input **Status** field will display either ON or OFF. Figure 16-3 contains the list of modules whose status can be reviewed from this screen.

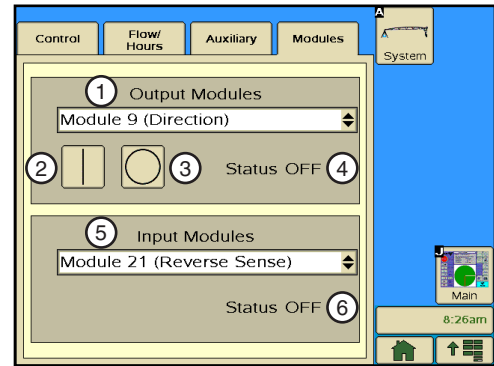

Figure 16-1 1. Output Control Modules
2. On Button
3. Off Button
4. Output Module Status
5. Input Status Modules
6. Input Module Status

Input Module #	Relay
16	Remote Start
17	Pressure
18	3-Second Timer
19	Auxiliary 2
20	Auxiliary 1
21	Reverse Sense
22	Forward Sense
23	Safety Sense
24	PC4
25	PC5

Figure 16-3 Input Status Modules

Setup Screen

The user can change settings or view information from the Setup screen at anytime. Refer to Figure 17-1.

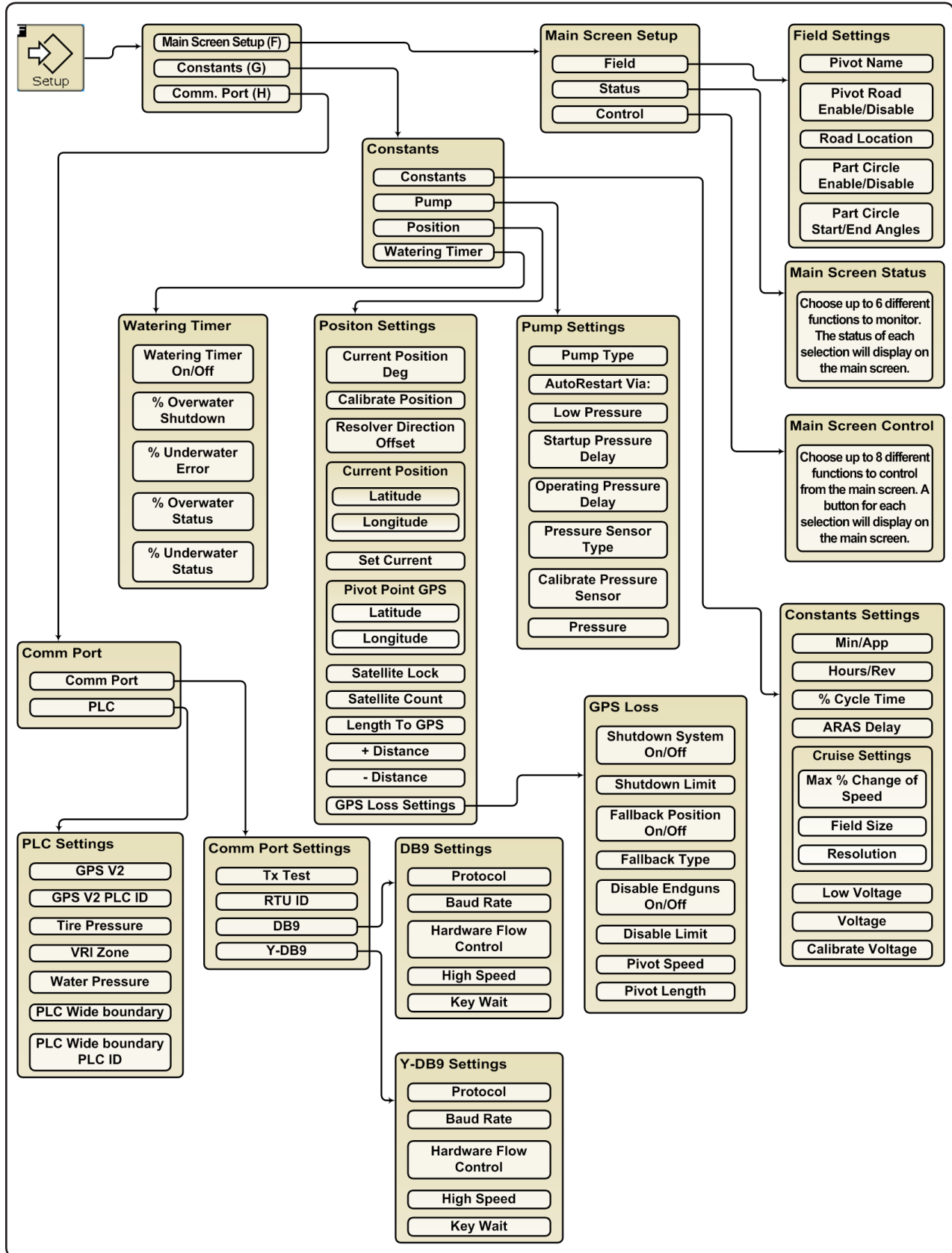

Figure 17-1

Setup

Main Screen Setup

Push **Setup, Main Screen Setup** to display the Setup screen. Refer to Figures 18-1 and 18-2.

Main Screen Setup is used to set the Pivot Name, enable the Pivot Road and set the position, and change Pivot Circle Constants (enable Part Circle and set the start and end angles). It is also used to establish which functions will be monitored, and which functions will be controlled on the Main screen.

Field

Pivot Name

1. To set the pivot name, Push **Setup, Main Screen Setup, Field** to display the field settings. Refer to Figure 18-3.
2. Select the **Pivot Name** field.
3. Enter the pivot name.
4. Push **Enter** to retain the value.

Pivot Road

1. To enable the pivot road and set the position, Push **Setup, Main Screen Setup, Field** to display the field settings. Refer to Figure 18-3.
2. Check the **Pivot Road** check box to enable.
3. Select the **Degree** field.
4. Enter the Pivot Road position from 0.0° to 359.9°.
5. Push **Enter** to retain the value.

Pivot Circle Constants

If this is a full circle pivot, no changes need to be made. However, if this is a part circle pivot, enable Part Circle and set the start and end angles.

1. To enable part circle pivot and set the start and end angles, Push **Setup, Main Screen Setup, Field** to display the field settings. Refer to Figure 18-3.
2. Check the **Part Circle** check box to enable.
3. Select the **Start Angle** field.
4. Enter the start angle from 0.0° to 359.9°.
5. Push **Enter** to retain the value.
6. Select the **End Angle** field.
7. Enter the end angle from 0.0° to 359.9°.
8. Push **Enter** to retain the value.

The field information is now complete. Refer to Figure 18-4.

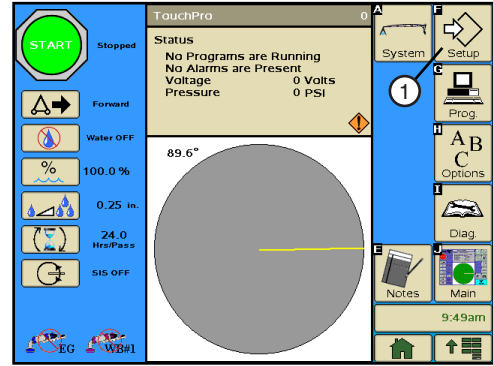

Figure 18-1 Main Screen
1. Setup Button

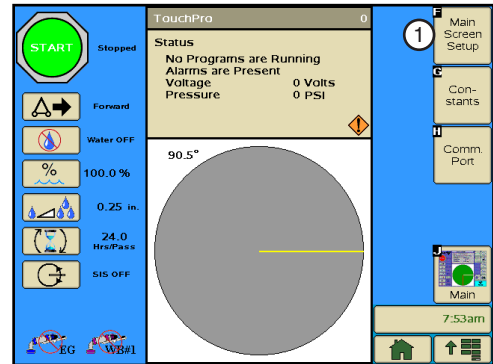

Figure 18-2 Setup Screen
1. Main Screen Setup Button

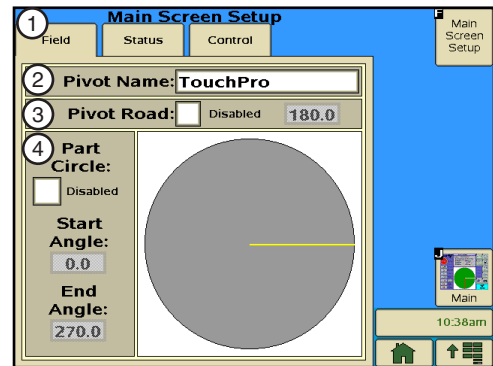

Figure 18-3 1. Field Tab
2. Pivot Name
3. Pivot Road
4. Part Circle

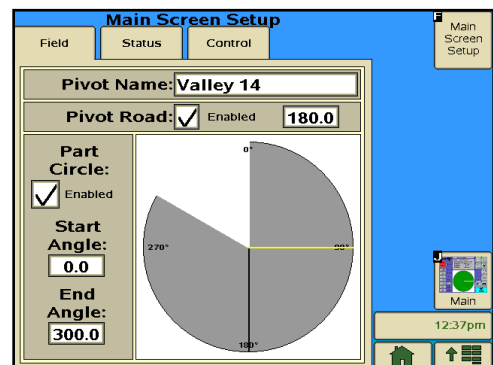

Figure 18-4 Completed Field Screen

Main Screen Setup

Status

Choose up to six different functions to monitor on the Main screen. The status of each selection will be displayed in the top center of the Main screen.

1. To set the Main screen status lines, push **Setup, Main Screen Setup, Status, Status** to display the status line fields. Refer to Figure 19-1.
2. Select a **Status Line** field.
3. Choose the status to be displayed in the drop-down menu.
4. Repeat step 2 and 3 for the other status line fields.

The status of the following functions can be displayed.

- Programs
- Alarms
- Voltage
- Pressure
- Hours/Pass
- Position
- Total Hours
- Wet Hours
- Flow Meter
- Temperature
- Wind
- Rain
- End Pressure
- Adjusted %
- Empty

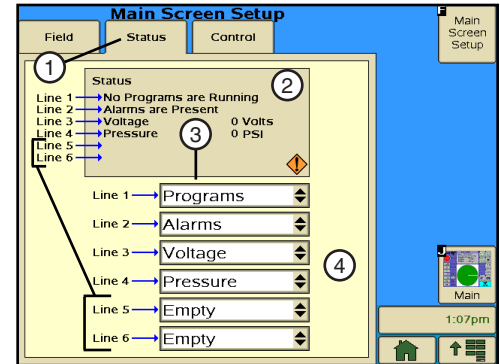

Figure 19-1 1. Status Tab
2. Status Displayed on Main Screen
3. Status Line Field
4. Function Selection Area

Setup

Main Screen Setup

Control

Choose up to eight different functions to control from the main screen. Refer to Figure 20-1. A button for each selection will display on the main screen. The default selections are: Position 1 - Direction, Position 2 - Water, Position 3 - Percentage, Position 4 - Depth, Position 5 - Hrs/Pass, Position 6 - Stop In Slot, Position 7 - Empty, Position 8 - Endgun.

1. To set the main screen controls, Push **Setup, Main Screen Setup, Control** to display the control fields. Refer to Figure 20-2.
2. Select a **Control** field.
3. Choose the control to be displayed in the drop-down menu.
4. Repeat step 2 and 3 for any other control fields.

Control of the following functions can be selected.

- Direction
- Water
- Percentage
- Depth
- Hours/Pass
- Stop-In-Slot
- End Gun
- AR/AS
- Autorestart
- AUX1
- AUX2
- AUX IN Status
- RD1
- RD2
- DO1
- DO2
- Wide Boundary 2 & 3
- Empty

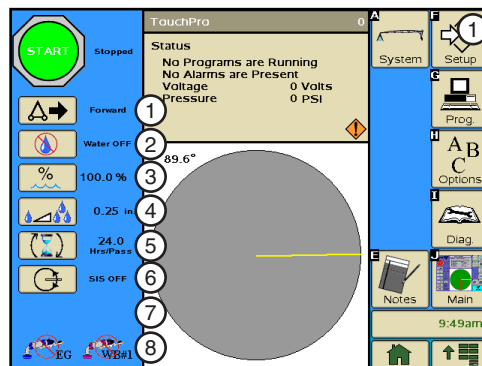

Figure 20-1 Positions 1 through 8

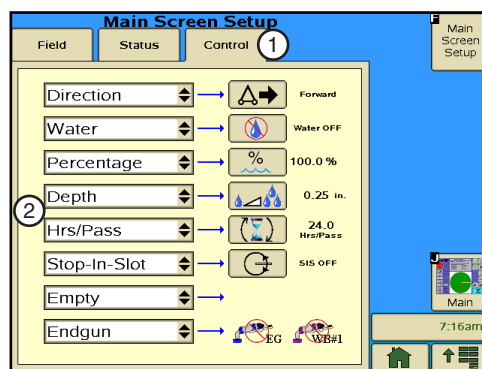

Figure 20-2 1. Control Tab
2. Control Fields

Constants

Constants

Constants is used to set up features and functions that will change very little over time. These include the minimum water application, hours per revolution, percent cycle time, ARAS delay, cruise settings, and voltage settings.

Constants Setup

Push **Setup, Constants** to display the Constants Setup screen. Refer to Figures 21-1 and 21-2.

Minimum Application (Min/App)

Minimum Application is used to set the depth of water applied at a percentage timer setting of 100 percent.

The minimum application value is specific to the machine, and is used to calculate water applications at different machine speeds. Refer to the machine's VChart Timer Report for this value, or contact your Valley dealer. The minimum application factory default setting is 0.250 inches (6.35 mm).

Setting Minimum Application

To set the minimum application, follow these steps.

1. Push the **Constants** tab to display the Constants settings. Refer to Figure 21-3.
2. Select the **Minimum Application** field.
3. Using the numeric keypad, enter the minimum application from 0.001 to 1.000 in, or 0.001 to 25.40 mm, from the VChart Timer Report.
4. Push **Enter** to retain the value.

Hours Per Revolution (Hours/Rev)

The **Hours Per Revolution** field is used to set the number of hours required, at a percent timer setting of 100%, for the machine to make one complete revolution.

The Hours per Revolution value is used to calculate hours per revolution for different percent timer settings, and is displayed on the Main screen. The value is specific to the machine. Refer to your machine's VChart Timer Report for this value, or contact your Valley dealer. The default setting is 24.0 hours.

Setting Hours Per Revolution

To set the hours per revolution, follow these steps.

1. Select the **Hours Per Revolution** field.
2. Using the numeric keypad, enter the hours per revolution from the VChart Timer Report at 100%.
3. Push **Enter** to retain the value.

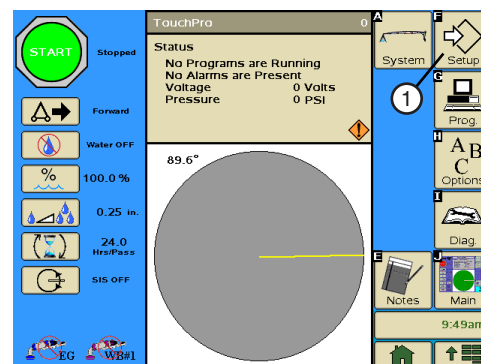

Figure 21-1 Main Screen
1. Setup Button



Figure 21-2 Setup Screen
1. Constants Setup Button

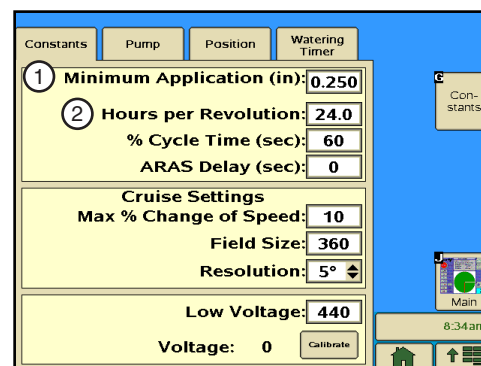

Figure 21-3 Constants Tab
1. Minimum Application Field
2. Hours per Revolution Field

Setup

Constants

% Cycle Time

% Cycle Time is used to set the Percent Timer cycle time. The Percent Timer cycle time factory default setting is 60 seconds. When the Percent Timer cycle time is set at 60 seconds, and the Percent Timer is set at 50 percent, the end tower moves for 30 seconds of each minute. The percent timer cycle time can be set from 20 to 200 seconds.



CAUTION

- INCREASING THE PERCENT TIMER CYCLE TIME SETTING OVER 60 SECONDS MAY CAUSE UN-EVEN WATER DISTRIBUTION.

Setting % Cycle Time

To set the Percent Timer cycle time, follow these steps.

1. Select the **% Cycle Time** field.
2. Using the numeric keypad, enter the percent timer cycle time in seconds.
3. Push **Enter** to retain the value.

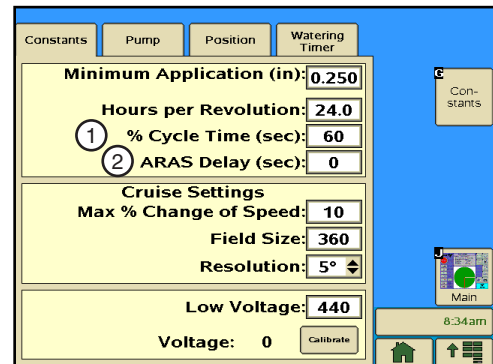

Figure 22-1 1. % Cycle Time Field
2. ARAS Delay Field

Auto Reverse Auto Stop Delay (ARAS Delay)

Auto Reverse Auto Stop Delay (ARAS Delay) is used to set the delay time when a machine is equipped with a drive-unit-mounted end-of-field stop/auto reverse. Refer to Figure 22-1. If the machine is NOT equipped with a drive-unit-mounted end-of-field auto stop/auto reverse, leave the ARAS Delay at 0 seconds and the Auto Reverse/Auto Stop option OFF. The Auto Reverse/Auto Stop default setting is OFF. The AR/AS delay time default setting is 0 seconds. The Automatic Reverse/Automatic Stop option is enabled and disabled from the Main screen. Refer to Auto Reverse in the Options section of this manual to select which option to use, either Auto Reverse or Auto Stop.

Operation:

- Auto Reverse; If AR/AS is on, water is on, and the Auto Reverse/Auto Stop option is set to Auto Reverse, when the actuator arm is tripped the machine changes direction, disables the percent timer, waits for the set AR/AS delay time, and then enables the percent timer and continues running.
- Auto Stop; If AR/AS is on, water is on, and the Auto Reverse/Auto Stop option is set to Auto Stop, when the actuator arm is tripped the machine changes directions, disables the percent timer, waits for the set AR/AS delay time, and then shuts down.
- AR/AS delay only occurs when AR/AS is on, water is on, and an AR/AS event has occurred.
- If AR/AS is off, the machine shuts down when the actuator arm is tripped.



CAUTION

- WHEN A MACHINE MUST REVERSE AROUND AN OBSTACLE, A DRIVE-UNIT-MOUNTED END-OF-FIELD AUTO STOP/AUTO REVERSE MUST BE INSTALLED, WITH PHYSICAL BARRIERS AS A SAFETY BACK-UP.

Constants

Setting ARAS Delay

To set the ARAS Delay, follow these steps.

1. Select the **ARAS Delay** field. Refer to Figure 23-1.
2. Using the numeric keypad, enter the ARAS Delay time in seconds.
3. Push **Enter** to retain the value.

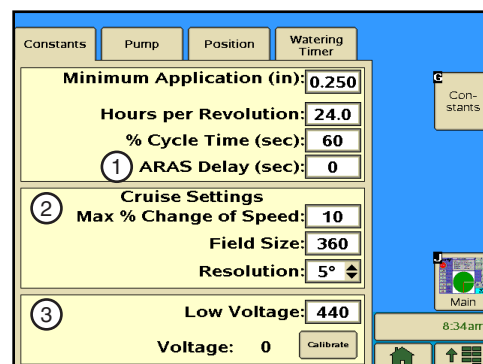

Figure 23-1 1. ARAS Delay Field
2. Cruise Control Settings
3. Voltage Settings

Cruise Settings

The Cruise Control settings for the **Max % Change Of Speed**, **Field Size In Degrees**, and **Resolution** constants can be viewed or changed from the Constants screen.

Max % Change Of Speed

Max % Change Of Speed is used to view and change the maximum percentage change of speed. This value is the maximum percentage of change in speed that Cruise Control is allowed to make. The default setting is 10%. The range is 0% to 255%. When set to 0%, Cruise Control is not allowed to change the speed. When set to 255%, Cruise Control is allowed to change 255% of the set % timer setting.

For example, if the Percent Timer is set to 20% and the Max % Change Of Speed is set to 50%, then Cruise Control can adjust the Percent Timer in a range from 10%-30%.

1. Select the **Max % Change Of Speed** field. Refer to Figure 23-1.
2. Enter a percentage from 0 to 255.
3. Push **Enter** to retain the value.

Field Size In Degrees

Field Size In Degrees is used to view and change the field size. This value is the field size in degrees, and assumes that the field always starts at 0 degrees. The default is 360 degrees. The range is 15 to 360 degrees.

1. Select the **Field Size** field. Refer to Figure 23-1.
2. Enter a degree from 15 to 360.
3. Push **Enter** to retain the value.

Resolution

Resolution is used to view and adjust the speed of the machine. This value is the number of degrees that the control panel uses to measure time per revolution. The default setting is 5 degrees. The settings are 1, 5, 10 and 15 degrees.

1. Select the **Resolution** field. Refer to Figure 23-1.
 2. To change the resolution, choose one of the following from the drop-down menu.
 - 15 degree
 - 10 degree
 - 5 degree*
 - 1 degree*
- * **Not recommended for a resolver-based position**

Setup

Constants

Low Voltage

The Low Voltage constant is used to set the low voltage limit. The low voltage limit factory default setting is 440 volts for use with a supply voltage of 480 VAC @ 60Hz. Recommended low voltage limits for other supply voltages are shown in the Recommended Low Voltage chart. Refer to Figure 24-1.

If the control panel voltmeter senses voltage below the low voltage limit, a built-in timer keeps the machine running for up to 15 seconds to prevent nuisance shutdowns due to voltage fluctuations.

If the low voltage condition still exists after 15 seconds, the machine is shut down and the diagnostics screen will display a fault for machine power.

Nominal Supply Voltage	Recommended Low Voltage Setting
480 VAC @ 60Hz	440 VAC
415 VAC @ 50Hz	375 VAC
400 VAC @ 50Hz	365 VAC
380 VAC @ 50Hz	355 VAC
230 VAC @ 60Hz	220 VAC
220 VAC @ 50Hz	210 VAC
120 VAC @ 60Hz	105 VAC
110 VAC @ 50Hz	95 VAC

Figure 24-1 Recommended Low Voltage

CAUTION

- DO NOT SET LOW VOLTAGE LOWER THAN THE RECOMMENDED LOW VOLTAGE LIMIT.
- LOW VOLTAGE WILL DAMAGE THE DRIVE MOTORS AND OTHER ELECTRICAL COMPONENTS. CORRECT THE PROBLEM BEFORE RESUMING OPERATION

Setting Low Voltage

To set the Low Voltage limit, follow these steps.

1. Select the **Low Voltage** field. Refer to Figure 24-1.
2. Using the numeric keypad, enter the low voltage limit in volts.
3. Push **Enter** to retain the value.

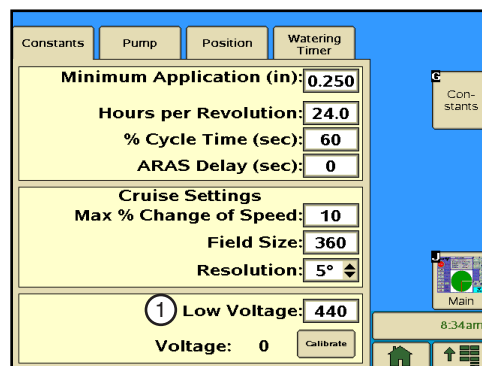

Figure 24-1 1. Low Voltage Field

Constants

Voltage Calibration

The Voltage constant calibrates the volt meter with the actual voltage coming into the control panel so that the voltage fluctuations can be monitored correctly.

The incoming voltage to the control panel must be measured with a meter by a qualified electrician or service person. This value is entered as the voltage constant.

The supply voltage should never exceed the limits shown in the Maximum Supply Voltage chart. Refer to Figure 25-1.

Nominal Supply Voltage	Maximum Supply Voltage
480 VAC @ 60Hz	505 VAC
415 VAC @ 50Hz	420 VAC
400 VAC @ 50Hz	420 VAC
380 VAC @ 50Hz	420 VAC
230 VAC @ 60Hz	253 VAC
220 VAC @ 50Hz	243 VAC
120 VAC @ 60Hz	132 VAC
110 VAC @ 50Hz	121 VAC

Figure 25-1 Maximum Supply Voltage

Setting Voltage

To set the voltage, follow these steps.

1. Push the **Calibrate** button. Refer to Figure 25-1.
2. Using the numeric keypad, enter the actual measured voltage.
3. Push **Enter** to retain the value.

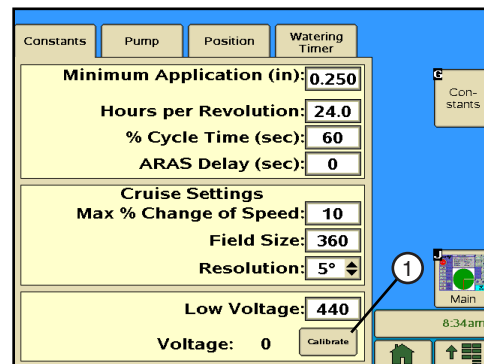

Figure 25-2 1. Calibrate Button

Setup

Constants

Pump

Pump Type

The **Pump Type** field is used to select and control the type of pumping unit that is being used with the machine. The choices are Engine Alt, Engine, and Electric Pump. The factory default setting is Electric Pump.

Engine and **Engine Alt** indicates a combustion engine is being used as the power for operating the pump. The Engine mode keeps the pump safety relay engaged while the machine is running, water on or water off, and disengages the relay when the machine is stopped.

- **Engine Alt** (Alternate) stops the machine after a 1.5 second delay. This allows 1.5 seconds for the TouchPro module to save the updated status, then disengage the engine. The Alt shutdown sequence is required for saving the event on the History Review screen and the Diagnostics log before power is gone.
- **Engine** stops the machine and disengages the engine simultaneously after a 3.0 second delay. However, this incorrectly logs a safety shutdown as a power fault.
- **Electric Pump** indicates an electric motor is being used to operate the pumping unit. The Pump mode engages the pump safety relay when water is turned on, and disengages the relay when water is turned off.

Setting Pump

To set the type of pumping unit, follow these steps.

1. Push **Setup, Constants, Pump** to display the Pump settings. Refer to Figure 26-1.
2. Select the **Pump Type** field.
3. Choose the type of pumping unit:
 - Engine Alt
 - Engine
 - Electric Pump

AutoRestart Via: (Auto Restart)

Use the Auto Restart Via option to restart a machine automatically if it was last shut down because of a loss of power or pressure. Refer to Figure 26-1.

When Auto Restart is ON, a *****RESTART***** message is displayed on the Main screen to remind the user that the machine is programmed to restart automatically. Refer to Figure 26-2.

NOTE: The ***RESTART***** message is also shown on the Main screen when DAILY OPS is on and activated. The user must verify that Auto Restart is on if a restart due to the loss of power or pressure is desired.**

- If the machine is shut down by pushing the STOP key, by the stop-in-slot position, or by a programmed shutdown, Auto Restart is temporarily disabled by the control panel, and the *****RESTART***** message disappears from the main screen.
- If the operator starts the machine again by pushing the START key, or by a programmed start, the *****RESTART***** message appears on the main screen and auto restart is active again.

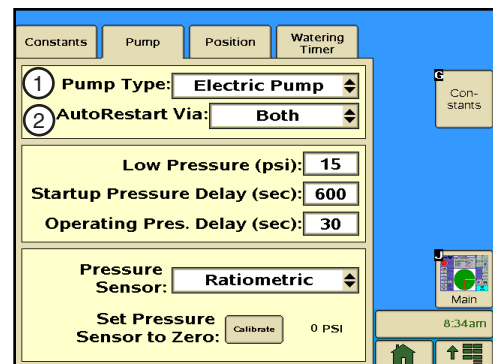

Figure 26-1 1. Pump Type Field
2. AutoRestart Via: Field

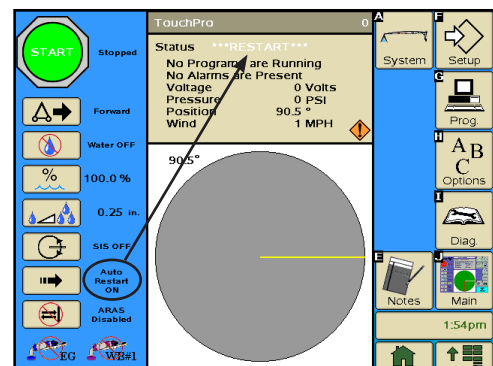

Figure 26-2 *****RESTART***** Message

Constants

Pump

Pressure Restart

When Auto Restart is on and a shutdown occurs because of a loss of water pressure, the machine restarts when pressure is regained and reaches the low pressure limit. Pressure restart does NOT use the START\$ program unless the power is cycled. If a machine restarts due to a loss of pressure, it starts with the same running conditions as when it previously lost pressure, just as if the **START** button was pushed.

Power Restart

When Auto Restart is on and a shutdown occurs because of a loss of power, the control panel runs the START\$ program when power is restored.

The START\$ program must contain all commands required to restart the machine to the desired status, including an adequate delay and the **Start** command. This is important when a pump restart delay is required after a momentary loss of power resulting in a shutdown.

NOTE

If **START\$** is not programmed with a start-up procedure, power restart does not operate correctly, even though Auto Restart is on.

If a machine was shut down by pushing **STOP**, by the stop-in-slot position, or by a programmed shutdown, it does NOT power restart if the power disconnect was turned off and then on to simulate a loss of power, because the initial shutdown was not caused by loss of power or pressure.

Setting Auto Restart

To set the Auto Restart mode, follow these steps.

1. Select the **AutoRestart Via:** field. Refer to Figure 27-1.
2. Choose the mode of restart from the drop-down menu.
 - Pressure
 - Power
 - Both

Using Auto Restart

To command the Auto Restart option ON or OFF, do the following.

- From the Main screen, push **System, Control, Auto Restart ON/OFF** to turn Auto Restart ON or OFF. Refer to Figure 27-2.

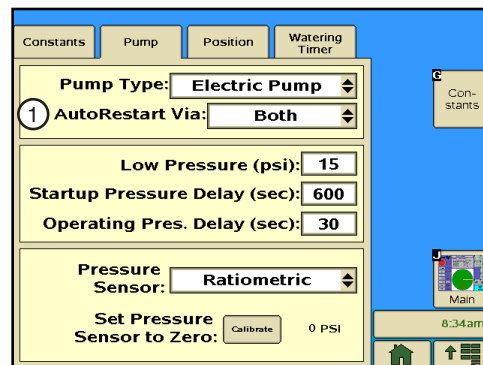

Figure 27-1 1. AutoRestart Via Field

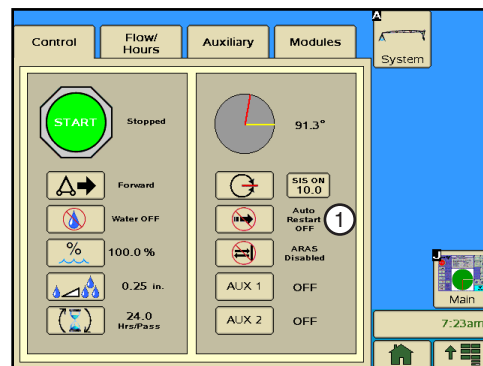

Figure 27-2 1. Auto Restart ON/OFF Button

Setup

Constants

Low Pressure

Low Pressure is used to set the water pressure minimum that must be met before the machine runs or continues running. Refer to Figure 28-1.

If the water pressure in the machine falls below the low pressure limit, and the pressure delays have expired, the machine and water supply (if wired to do so) shut down due to a pressure fault, which is displayed on the Diagnostics/Faults/System Faults screen. The low pressure limit factory default setting is 15 psi (103 kPa).

Setting Low Pressure

To set the low pressure limit, follow these steps.

1. Push **Setup, Constants, Pump** to display the Low Pressure settings. Refer to Figure 28-1.
2. Select the **Low Pressure** field.
3. Using the numeric keypad, enter a pressure value in either Pounds Per Square Inch (psi) or Kilopascal (kPa).
4. Push **Enter** to retain the value.

NOTE: If a mechanical pressure switch is used, set the Low Pressure field to 100 psi (689.4 kPa). The switch should be adjusted manually, and should indicate either an open condition (low pressure) or a closed condition (sufficient pressure). To select the type of pressure sensor to be used, refer to Pressure Sensor in this section.

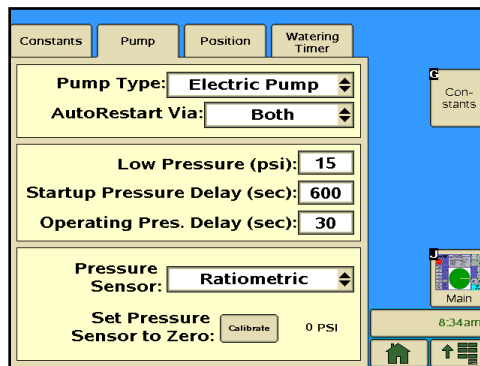

Figure 28-1 1. Low Pressure Field
2. Startup Pressure Delay Field
3. Operating Pressure Delay Field

Startup Pressure Delay

Startup Pressure Delay bypasses the pressure transducer for the amount of time required in seconds for the machine to initially build water pressure above the low pressure limit after the pump has been started. The Startup Pressure Delay setting has a range of 0 to 5000 seconds. The factory default is set to 600 seconds, or 10 minutes. Refer to Figure 28-1.

NOTE: If a mechanical pressure switch is used, the Startup Pressure Delay constant must be entered as the amount of time required for the pressure switch to close.

Operating Pressure Delay

Operating Pressure Delay is active only after the Startup Pressure Delay time setting has expired. The operating pressure delay is the amount of time in seconds that the machine continues operating after pressure drops below the low pressure limit. The operating pressure delay has a range of 0 to 5000 seconds. The factory default is set to 30 seconds of continuous pressure loss. The operating pressure delay is reset when pressure rises above the low pressure limit. Refer to Figure 28-1.

If the water pressure does not reach the low pressure limit before the startup pressure delay expires, error code E06 PUMP SAFETY - PRESSURE TOO LOW AFTER PRESSURE DELAY is displayed on the Main screen, and the operating pressure delay takes over.

If the water pressure does not reach the low pressure limit before the operating pressure delay time expires, the machine is shut down due to a pressure fault, which is displayed on the Diagnostics/Faults/System Faults screen and the Main screen.

Constants

Setting Pressure Delays

To set the Startup and Operating Pressure Delays, follow these steps.

1. Push **Setup**, **Constants**, **Pump** to display the **Startup Pressure Delay** and **Operating Pressure Delay** fields. Refer to Figure 29-1.
2. Select either the **Startup Pressure Delay** field or the **Operating Pressure Delay** field.
3. Using the numeric keypad, enter the delay time in seconds.
4. Push **Enter** to retain the value.
5. Repeat steps 2-4 for the other pressure delay.

Pressure Sensor

The **Pressure Sensor** field is used to identify the type of pressure sensor being used on the machine. The Pressure Sensor default setting is Ratiometric. There are three pressure sensor types available:

- Ratiometric - for pressure transducer.
- Absolute - for pressure transducer.
- Pressure Switch - for mechanical pressure switch.

Setting Pressure Sensor

To set the pressure sensor type, follow these steps.

1. Push **Setup**, **Constants**, **Pump** to display the **Pressure Sensor** setting. Refer to Figure 29-1.
2. Select the **Pressure Sensor** field.
3. Choose the pressure sensor type from the drop-down menu.

NOTE: When the type of pressure switch is selected, transducer-related error codes do not appear on the Main screen. The main screen displays LOW or OK instead of a pressure value.

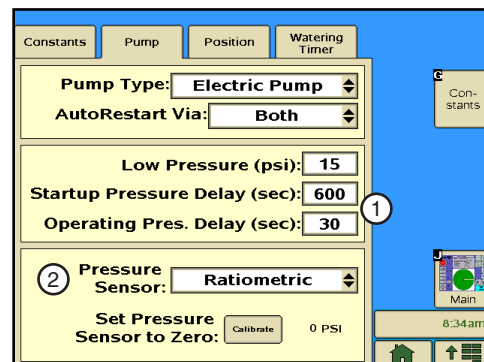

Figure 29-1 1. Startup and Operating Pressure Delay Fields
2. Pressure Sensor Field

Setup

Constants

Calibrate Pressure Sensor

Calibrate Pressure Sensor is used to calibrate the pressure transducer to the current water pressure reading of zero when the pump is off and the machine is dry.

Calibrating

To calibrate the pressure transducer to zero, follow these steps.

1. Make sure the pump is off and the machine is dry.
2. Push **Setup, Constants, Pump** to display the pressure sensor **Calibrate** button. Refer to Figure 30-1.
3. Push the **Calibrate** button.

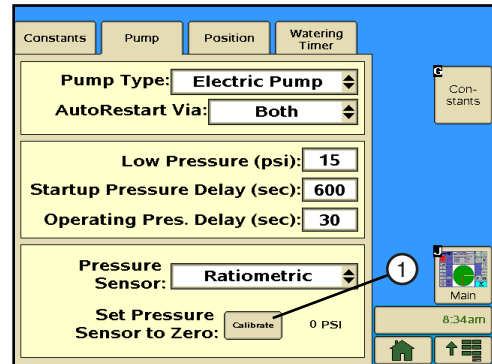

Figure 30-1 1. Calibrate Button

Constants

Position

Position is the current pivot position in the field, defined as a degree location between 0.0° and 359.9°, and shown on the Main screen. Typically, the 0° pivot position is set to due north. However, any pivot location can be the 0° position. When using GPS position, the Communications (Com) Port protocol must first be set up for GPS V1 or GPS V2, depending on the power line carrier board firmware version. The GPS position of the pivot point must then be set before the current pivot position in the field.

Setting Up the Com Port

Refer to the Com Port area of this section for information about setting up the Com Port.

Setting Position

NOTE

Changing the pivot position affects the location in the field from which the end gun, wide boundary, stop-in-slot, and programs are controlled.

To set the position, follow these steps.

1. Push **Setup, Constants, Position** to display the Position settings. Refer to Figure 31-1.
2. Push the **Calibrate** Button.
3. Using the numeric keypad, enter the current pivot position from 0.0° to 359.9°.
4. Push **Enter** to retain the value.

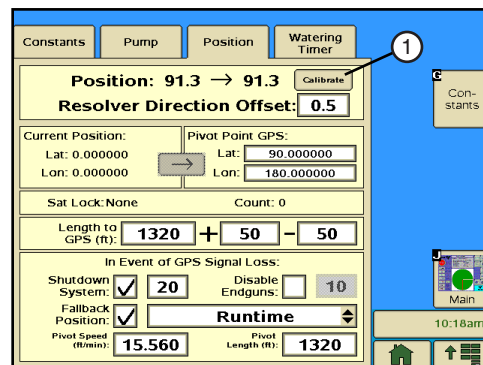

Figure 31-1 1. Calibrate Button

Setup

Constants

Resolver Direction Offset

Resolver Direction Offset (Direction Offset) is used to adjust, or offset, the actual pivot position of the machine so that the End Gun on/off locations, Wide Boundary on/off locations, Stop-In-Slot locations, or any other position-based command locations are repeatable when the direction of the machine is changed. A repeatable accuracy of $\pm 1^\circ$ can be expected. The Dir Offset factory default setting is 0.5° and is adjustable from 0° to 10° .

Estimating the Direction Offset

If, after changing directions, the machine runs/stops past the normal End Gun on/off locations, Wide Boundary on/off locations, Stop-In-Slot location or any other position based program locations by an estimated value of 1.0° , the direction offset needs to be increased by $1/2$ of the estimated value, which in this case is 0.5° . Refer to Figure 32-1.

1. Measure the distance in feet from where the machine stopped to where it should have stopped. This is the measured offset.

Measured Offset _____

2. The table in Figure 32-2 lists the approximate length of a 1° offset, based on machine length. Find and record the approximate 1° offset for your machine length.

Approximate Offset _____

3. Calculate the value for the estimated offset, based on whether the machine runs/stops past or runs/stops short of the position. Then set the new direction offset. Refer to Figure 32-3.

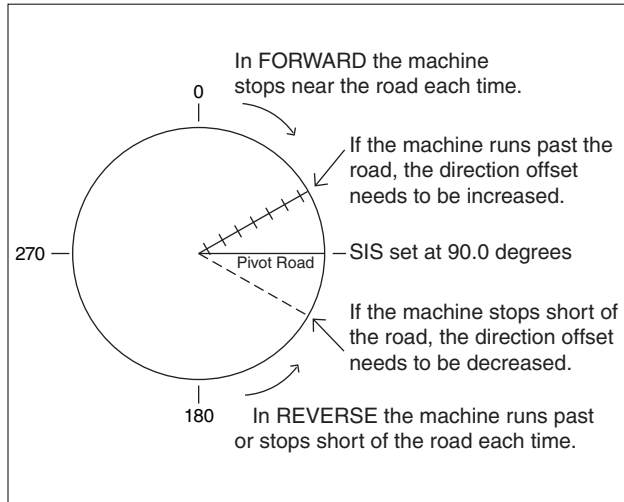

Figure 32-1

Machine Length (Feet)	115	230	345	460	575	690	805	920	1035	1150	1265	1380	1495	1610	1725
1 Degree Offset (Feet)	2	4	6	8	10	12	14	16	18	20	22	24	26	28	30
Machine Length (Meters)	35.0	70.1	105.1	140.2	175.2	210.3	245.3	280.4	315.4	350.5	385.5	420.6	455.6	490.7	525.7
1 Degree Offset (Meters)	0.6	1.2	1.8	2.4	3.0	3.6	4.2	4.8	5.4	6.0	6.7	7.3	7.9	8.5	9.1

Figure 32-2

Machine Runs/Stops Past Position:				Machine Runs/Stops Short of Position:			
Estimated Direction Offset	=	Current Direction + Offset	Measured (Offset) ÷ 2	Estimated Direction Offset	=	Current Direction - Offset	Measured (Offset) ÷ 2
	=	_____ +	(_____ ÷ _____)		=	_____ -	(_____ ÷ _____)
	=	_____ +	(_____)		=	_____ -	(_____)
	=	_____ +	_____		=	_____ -	_____
	=	_____	_____		=	_____	_____

Figure 32-3

Constants

Resolver Direction Offset

Calculating Direction Offset

To calculate the direction offset value, follow these steps.

1. Start the machine in the FORWARD or REVERSE running direction, and watch the position reading on the Main screen. For this example, the running direction used is REVERSE.

Stop the machine when the position changes by at least 7°. This indicates that the resolver is now turning as the pivot rotates.

2. Place a flag next to the wheel track and in line with the center of the rear wheel on the first regular drive unit. This is position A. Refer to Figure 33-1.

In the running direction opposite to that in step 1, measure a distance of 50 feet from position A along the first regular drive unit wheel track, and place another flag. This is position B. For this example, the opposite running direction is FORWARD.

3. Push **Setup**, **Constants**, **Position** to view the position of the machine. Refer to Figure 33-2.

Record the position displayed in the position field to the nearest tenth of a degree as position A.

Position A = _____ Degrees

4. Start the machine in the running direction opposite of that in step 1, and let it run exactly 50 feet. The flag at position B should be in line with the center of the rear wheel on the first regular drive unit. Then, stop the machine.

5. Push **Setup**, **Constants**, and **Position** to view the position of the machine.

Record the position displayed in the position field to the nearest tenth of a degree as position B.

Position B = _____ Degrees

6. Measure the distance in feet from the center of the pivot to the center line of the tire on the first regular drive unit. This distance is R. Refer to Figure 33-3.

R = _____ Feet

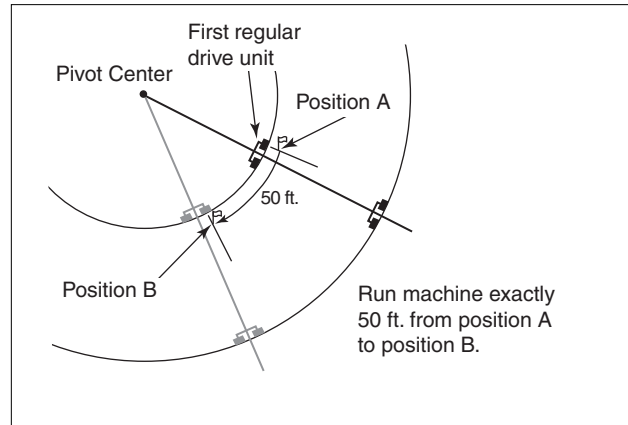

Figure 33-1

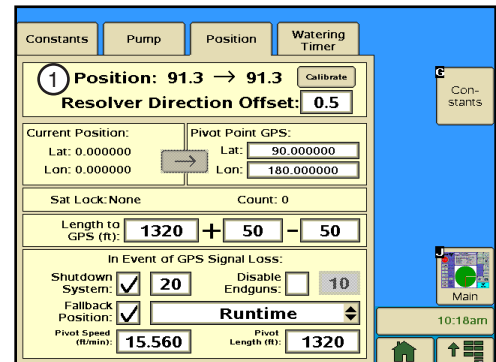

Figure 33-2 1. Position

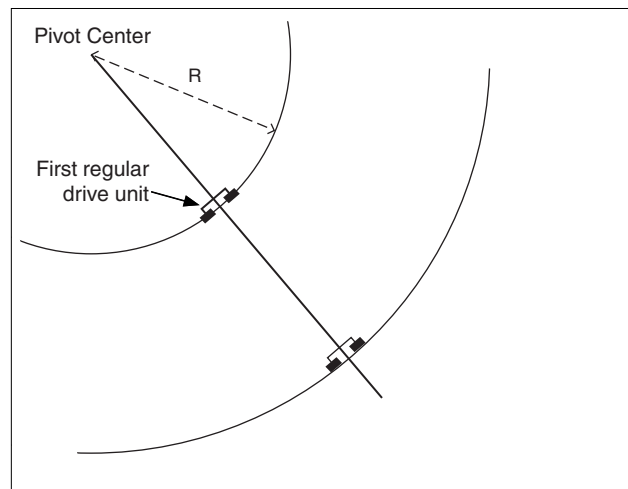

Figure 33-3

Setup

Constants

Resolver Direction Offset

Calculating Direction Offset (continued)

- Use the measured degrees formula to determine how many degrees the pivot should travel in 50 feet. This is the measured degrees. Refer to Figure 34-1.
- Use the actual degrees formula to determine the actual degrees traveled. This is the difference in readings between position A and position B.

NOTE: If this value is negative, drop the negative sign and use as a positive value.

- Push **Setup, Constants, Position** to view the **Resolver Direction Offset** field. Refer to Figure 34-2.

Record the current direction offset displayed in the resolver direction offset field.

Current Direction Offset = _____

- Calculate the value for the new direction offset using one of the two formulas shown below. Then set the new direction offset. Refer to Figure 34-3.

Measured Degrees Formula

$$\text{Measured Degrees} = (2864.8) / (R)$$

$$= (2864.8) / (\text{_____})$$

$$= \text{_____}$$

Actual Degrees Formula

$$\text{Actual Degrees} = \text{Position B} - \text{Position A}$$

$$= (\text{_____}) - (\text{_____})$$

$$= \text{_____}$$

Figure 34-1

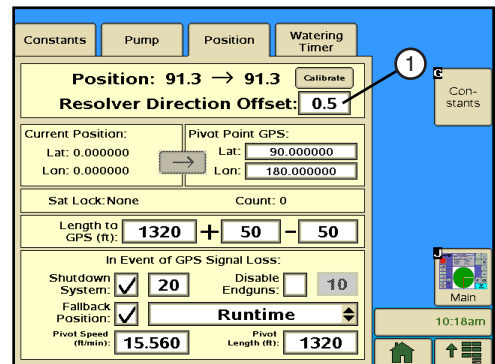

Figure 34-2 1. Resolver Directional Offset Field

<p>If the actual degrees are LESS THAN the measured degrees use the formula below:</p> $\text{New Direction Offset} = \text{Current Direction Offset} + \left[\frac{(\text{Measured Degrees}) - (\text{Actual Degrees})}{2} \right]$ $= \text{_____} + \left[\frac{(\text{_____}) - (\text{_____})}{2} \right]$ $= \text{_____} + \left[\frac{(\text{_____})}{2} \right]$ $= \text{_____} + \text{_____}$ $= \text{_____}$	<p>If the actual degrees are GREATER THAN the measured degrees use the formula below:</p> $\text{New Direction Offset} = \text{Current Direction Offset} - \left[\frac{(\text{Actual Degrees}) - (\text{Measured Degrees})}{2} \right]$ $= \text{_____} - \left[\frac{(\text{_____}) - (\text{_____})}{2} \right]$ $= \text{_____} - \left[\frac{(\text{_____})}{2} \right]$ $= \text{_____} - \text{_____}$ $= \text{_____}$
--	---

Figure 34-3

Constants

Setting Dir Offset

To set the direction offset, follow these steps.

1. Push **Setup, Constants, Position** to display the Position settings. Refer to Figure 35-1.
2. Select the **Resolver Direction Offset** Field.
3. Using the numeric keypad, enter the Resolver Direction Offset value in degrees.
4. Push **Enter** to retain the value.

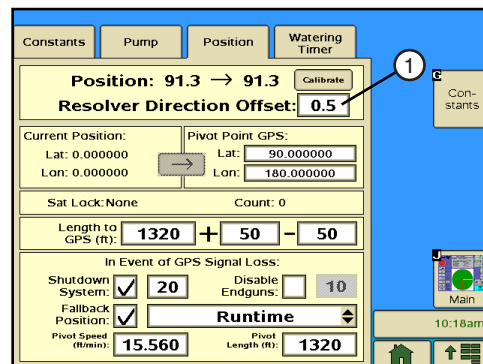

Figure 35-1 1. Resolver Directional Offset Field

Setup

NOTE

If the **Communications (Com) Port protocol** is not set up for **GPS V1** or **GPS V2**, none of the following fields will be visible on the TouchPro control panel. Refer to the **Com Port** area of this section for information about setting up the **Com Port**.

Current Position

Current Position displays the current latitude and longitude of the GPS antenna when its locked on the satellite signal. The current position is only displayed when the **Com Port** protocol is set to **GPS V1** or **PLC GPS V2**. Refer to Figure 36-1.

Pivot Point GPS

Pivot Point GPS displays the longitude and latitude of the pivot point. Pivot point GPS is only displayed when the **Com Port** protocol is set to **GPS V1** or **PLC GPS V2**. Refer to Figure 36-1.

Setting Pivot Point GPS

To set the pivot point GPS, follow these steps:

1. Push **Setup**, **Constants**, **Position** to display the Position settings. Refer to Figure 36-1.
2. Select the **Pivot Point GPS** latitude and longitude fields and enter the positions manually.
3. Push **Enter** to retain the value.

Satellite Lock

Satellite Lock displays the satellite signal (**None**, **Standard** or **DGPS**) that the GPS antenna is locked on. Refer to Figure 36-1.

Satellite Count

Satellite Count displays the number of satellites in view. Refer to Figure 36-1.

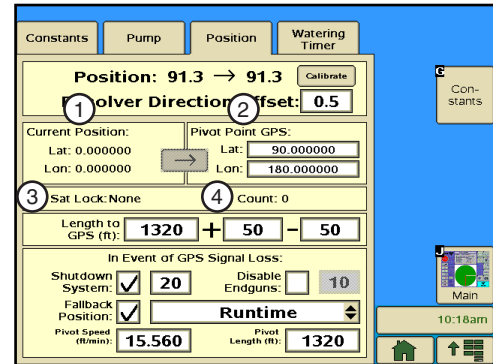

Figure 36-1 1. Current Position
2. Pivot Point GPS
3. Satellite Lock
4. Satellite Count

Constants

Length to GPS

Length to GPS is the length from the pivot point to the GPS antenna or GPS tower box.

Setting the Distance to GPS (The distance from pivot point to GPS tower box).

1. Push **Setup, Constants, Position** to display the Position settings. Refer to Figure 37-1.
2. Select the **Length to GPS** Field.
3. Using the numeric keypad, enter the length from the pivot point to the GPS antenna or GPS tower box. Do not enter the pivot length. The default is 1320 ft (402.3 m), and the range is 10 to 6554 ft (3.0 to 1997.6 m). Refer to Figure 37-1.
4. Push **Enter** to retain the value.
5. Select the **+** (**Plus**) Field.
6. Using the numeric keypad, enter the Plus tolerance for the length from pivot point to GPS antenna. The Default is 50 ft (15.2 m) and the range is 10 to 6554 ft (3.0 to 1997.6 m). A setting of 50 ft (15.2 m) or more is recommended to allow for variation in the GPS signal if Wide Area Application Services (WAAS) is unavailable. Refer to Figure 37-1.
7. Push **Enter** to retain the value.
8. Select the **-** (**Minus**) Field.
9. Using the numeric keypad, enter the Minus tolerance for the length from pivot point to GPS antenna. The Default is 50 ft (15.2 m) and the range is 10 to 6554 ft (3.0 to 1997.6 m). A setting of 50 ft (15.2 m) or more is recommended to allow for variation in the GPS signal if WAAS is unavailable.
10. Push **Enter** to retain the value.

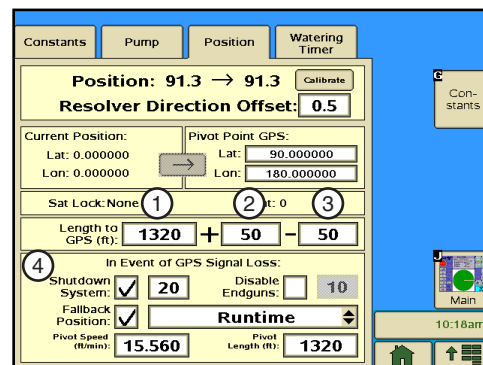

Figure 37-1 1. Length to GPS Field
2. + (Plus) Field
3. - (Minus) Field
4. Signal Loss Fields

GPS Signal Loss

The GPS Signal Loss constant is used when GPS is selected as the protocol. If the machine with GPS loses a signal, or has a loss of communication, the selected GPS Signal Loss commands occur. The three command options are listed below. Refer to Figure 37-1.

- **Shutdown System** - With this enabled, and if a loss of a signal or no communications to the GPS occurs for longer than the programmed delay, the machine logs the appropriate error code and system fault, and then shuts down.
- **Fallback Position** - With the runtime enabled and the loss of the GPS signal, the position is calculated based on runtime until the GPS position is reacquired. Resolver is not recommended as a fallback for GPS position loss. Only Runtime should be used.
- **Disable Endguns** - With this enabled, and a loss of a signal or no communications to the GPS occurs for longer than the programmed delay, the machine turns off the end gun and wide boundary outputs until the GPS signal is reacquired by the machine.

Setup

Constants

Setting GPS Signal Loss

To set the GPS Signal Loss commands, refer to Figure 38-1 and follow these steps.

1. Push **Setup, Constants, Position** to display the Position settings.
2. Check the **Shutdown System** check box to enable the Shutdown System command. The default setting is enabled (checked).
3. If enabled, select the **Delay Time** field.
4. Using the numeric keypad, enter the delay time in minutes. The default is 20 minutes.
5. Push **Enter** to retain the value.
6. Check the **Disable Endguns** check box to enable the Disable Endguns command. The default setting is disabled (unchecked).
7. If enabled, select the **Delay Time** field.
8. Using the numeric keypad, enter the delay time in minutes. The default is 10 minutes.
9. Push **Enter** to retain the value.
10. Check the **Fallback Position** check box to enable Fallback Position. The default setting is enabled (checked).
11. Select the **Fallback Position** field.
12. Choose **Run Time** as the fallback. Runtime is the default.
NOTE: Resolver is not recommended as a fallback for GPS.
13. Select the **Pivot Speed** field.
14. Using the numeric keypad, enter the pivot speed. 15.56 ft./min. is the default.
15. Push **Enter** to retain the value.
16. Select the **Pivot Length** field.
17. Using the numeric keypad, enter the pivot length. 1320 feet is the default.
18. Push **Enter** to retain the value.

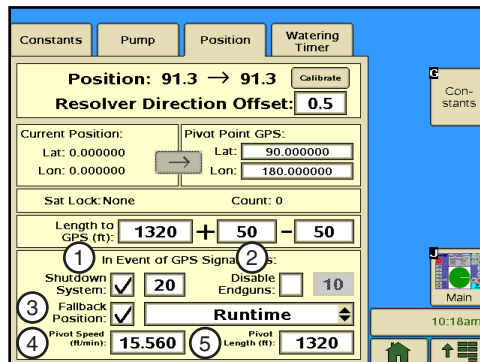

Figure 38-1 1. Shutdown System Checkbox & Delay Time Field
2. Disable Endguns Checkbox & Delay Time Field
3. Fallback Checkbox & Drop-Down Menu
4. Pivot Speed Field
5. Pivot Length Field

NOTE

Changing the pivot position affects the location in the field from which the end gun, wide boundary, stop-in-slot, and programs are controlled.

Constants

Watering Timer

Watering Timer provides separate timers for over-watering and under-watering conditions, and is used to monitor and control both. The Watering Timer feature is available for use with either GPS or Resolver.

Watering Timer On/Off

1. Push **Setup, Constants, Watering Timer** to display the Watering Timer screen. Refer to Figure 39-1.
2. Check the **Watering Timer** checkbox to turn the Watering Timer on. The default value is Watering Timer OFF (unchecked).

NOTE: The Watering Timer functions only when the machine is running with water on, and after the Startup Pressure Delay time period.

% Overwater Shutdown

% Overwater Shutdown allows the irrigation system to be shut down if the machine is moving too slowly, thereby applying too much water to all, or parts of the field.

The Overwatering Timer resets every tenth of a degree (0.1°) of movement and with a change in direction. It only increments if the Percentage Timer output is on, and after the Startup Pressure Delay time period.

1. To set the % Overwater Shutdown, push **Setup, Constants, Watering Timer** to display the Watering Timer screen. Refer to Figure 39-1.
2. Select the % **Overwater Shutdown** field.
3. Using the numeric keypad, enter the Overwater Shutdown number of minutes. The default is 100. The range is 3.4 to 102.4.
4. Push **Enter** to retain the value.

% Underwater Error

% Underwater Error creates an error if the irrigation system is moving faster than it should, thereby applying less water to all, or parts of the field.

The Underwatering Timer resets every five degrees (5°) of movement, and with a change in direction. It only increments if the Percentage Timer output is on, and after the Startup Pressure Delay time period.

1. To set the % Underwater Error, push **Setup, Constants, and Watering Timer** to display the Watering Timer screen. Refer to Figure 39-1.
2. Select the % **Underwater Error** field.
3. Using the numeric keypad, enter the Underwater Error number of minutes. The default is 50.
4. Push **Enter** to retain the value.

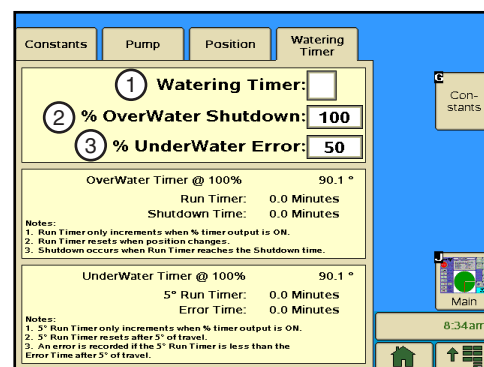

Figure 39-1 1. Watering Timer Checkbox
2. % Overwater Shutdown Field
3. % Underwater Error Field

Setup

Constants

Watering Timer Status

To view the status of the watering timers, push **Setup, Constants, Watering Timer** to display the Watering Timer screen. Refer to Figure 40-1.

Overwater Timer @ 100% (GPS position of machine in field)

- RUN TIMER - Time machine has run without moving. The Percent Timer must be ON for this to work. It is reset every 0.1°, or with a change in direction.
- SHUTDOWN TIME - Time at which the machine is shut down because of lack of movement.

Underwater Timer @ 100% (GPS position of machine in field)

- 5° RUN TIMER - Calculated time for machine to travel 5° at 100%.
- ERROR TIME - Actual travel time, if faster than calculated time. Then, an underwatering error is logged.

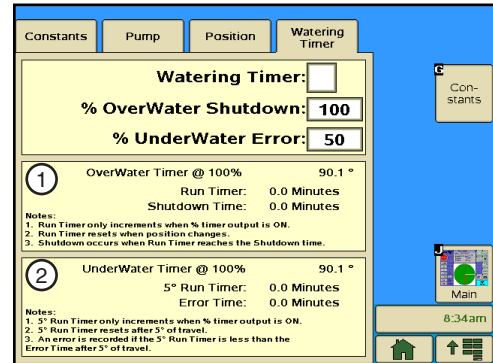

Figure 40-1 1. Overwater Timer Status
2. Underwater Timer Status

Communications Port

Comm. Port Tab

Comm. Port is used to set the control panel communications port, protocol, and baud rate for information that is transmitted and received when communicating with another computer. The baud rate must be set to match the other computer or communications equipment connected to the TouchPro control module. Refer to Figure 41-1.

Tx Test (Transmit) Button

Tx Test button sends current status information through an optional communication device, such as a radio or phone modem, to another control panel or Basestation equipped with a similar communication device. Use Tx Test to test communications after installation. There is a random 0 to 10 second delay prior to the transmission of data.

Using Transmit

To transmit current status information, push **Setup, Comm. Port, Comm Port, Tx Test**.

RTU ID

The RTU ID (Remote Telemetry Unit Identity) is set only when an optional remote telemetry device is used to communicate with the control panel. The control panel RTU ID is a unique number between 1 and 997 that the user selects. None of the user's other control panels or BaseStations can have the same RTU ID number.

- RTU ID number 0 is the factory default setting for all RTU devices.
- RTU ID numbers 998 and 999 are typically reserved for use by a primary BaseStation.

Setting the RTU ID

To set the RTU ID constant, follow these steps.

1. Select the **RTU ID** field. Refer to Figure 41-1.
2. Using the numeric keypad, enter the unique three-digit control module RTU ID.
3. Push **Enter** to retain the value.

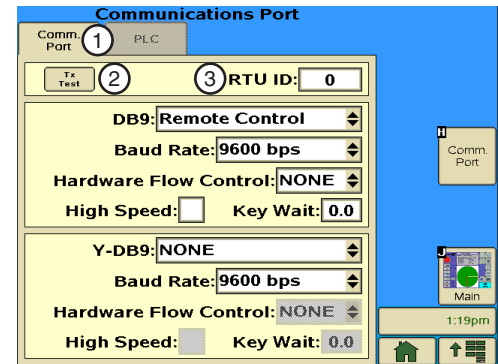

Figure 41-1 1. Comm. Port Tab
2. Tx Test Button
3. RTU ID Field

Setup

Communications Port

Comm. Port Tab

Setting Com Port

To set the communications port, protocol and baud rate, follow these steps.

1. Select either the **DB9** field or the **Y-DB9** field. Refer to Figure 42-1.
 - The DB9-Com Port is used as the telemetry connection for remote communications. The protocol default setting is Remote Control, and the baud rate default setting is 9600.
 - The Y-DB9 Com Port is used for direct connections to an option, or by Valley Dealers for service related functions. The protocol default setting is NONE, and the baud rate default setting is 9600.
2. Choose the desired protocol for the communications port.
 - REMOTE CTL
 - REMOTE CTL V2
 - SERVICE TOOL
 - GPS V1
 - PLC
 - NONE

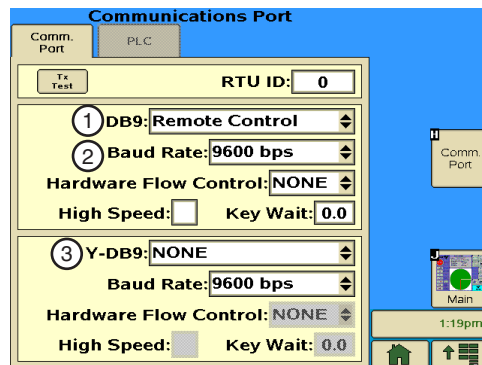

Figure 42-1 1. DB9 Field
2. Baud Rate Field
3. Y-DB9 Field

NOTE

A protocol can only be used by one Com Port at a time.

3. Select the **Baud** field and choose the desired baud rate for the communications port.

Depending on the protocol, other parameters like Hardware Flow Control, High Speed, and Key Wait may need to be set, or additional protocols may need to be selected on the PLC (Power Line Carrier) screen.

Communications Port

Comm. Port Tab

Hardware Flow Control

Hardware Flow Control is used to set how the control panel communications hardware sends and receives information. The hardware flow control factory default setting is NONE.

NOTE

Hardware Flow Control is only available when the Com Port protocol has been set up as Remote Control.

To set the Hardware Flow Control to be used by the control panel, do the following.

1. Push **Setup, Comm. Port, Comm Port** to display the Communications Port screen. Refer to Figure 43-1.
2. Select the **Hardware Flow Control** field for the com port.
3. Choose the hardware flow control type.
 - NONE.
 - CTS (Clear To Send).
 - DCD (Data Carrier Detect).

Set to NONE if hardware does not support CTS or DCD.

Key Wait

Key Wait is used to set the radio key wait time before transmission of data. The Key Wait default setting is 0.0 seconds.

NOTE

Key Wait is only available when the Com Port protocol has been set up as Remote Control.

To set the Key Wait time, follow these steps.

1. Select the **Key Wait** field for the com port. Refer to Figure 43-1.
2. Using the numeric keypad, enter the Key Wait delay time in seconds.
3. Push **Enter** to retain the value.

High Speed (High Speed Key Wait)

High Speed Key Wait is used for high speed communications hardware. The High Speed default is OFF. High Speed Key Wait is reserved for future applications.

NOTE

High Speed Key Wait is only available when the Com Port protocol has been set up as Remote Control.

To turn the High Speed Key Wait time on, check the **High Speed** check box. Refer to Figure 43-1.

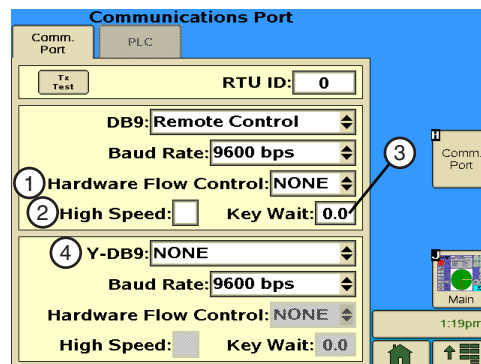

Figure 43-1 1. Hardware Flow Control Field
2. High Speed Checkbox
3. Key Wait Field
4. Y-DB Field

Setup

Communications Port PLC Tab

PLC (Power Line Carriers) is used to set the GPS V2, TPMS Tire Pressure, VRI-Zone, TPMS Water Pressure (End Pressure) and PLC wide boundary protocols.

1. Push **Setup, Comm. Port, Comm Port**.
The **PLC** tab is grayed out (inaccessible). Refer to Figure 44-1.
2. Select **PLC** from the **DB9** drop-down menu.
The **PLC** tab is now accessible. Refer to Figure 44-2.
3. Push the **PLC** tab to display the PLC screen. Refer to Figure 44-3.

GPS V2

GPS V2 is used to set protocol for the GPS Position option. The power line carriers must be running version 2 software. GPS Signal Loss constants are used to control the machine if GPS signal loss occurs.

- The GPS V2 PLC ID identifies the tower box that the GPS antenna is in.
- If PLC Wide boundary is used with GPS position, the GPS V2 protocol should be enabled after PLC Wide Boundary because the GPS V2 PLC ID must be the same as the PLC Wide Boundary PLC ID.

To enable GPS V2, follow these steps.

1. Push **Setup, Comm. Port, PLC** to display the PLC screen. Refer to Figure 44-3.
2. Check the GPS V2 check box to enable.
3. Select the GPS V2 PLC ID field.
4. Using the numeric keypad, enter the PLC ID tower box number.
5. Push Enter to retain the value.

TPMS Tire Pressure

TPMS Tire Pressure is used to set the protocol for the Tire Pressure Monitor option. Constants for Tire Pressure Monitor are set on the Tire Pressure Monitor screens in Options/TPMS.

- Constants, diagnostics, and data for TPMS are available in Options/TPMS.

To enable TPMS Tire Pressure, follow these steps.

1. Push **Setup, Comm. Port, PLC** to display the PLC screen. Refer to Figure 44-3.
2. Check the TPMS Tire Pressure checkbox to enable the monitoring system.

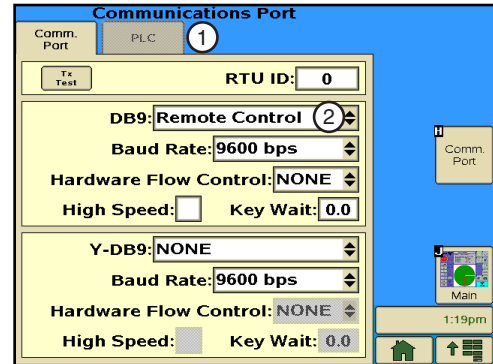

Figure 44-1 1. PLC Inaccessible
2. PLC Not Selected

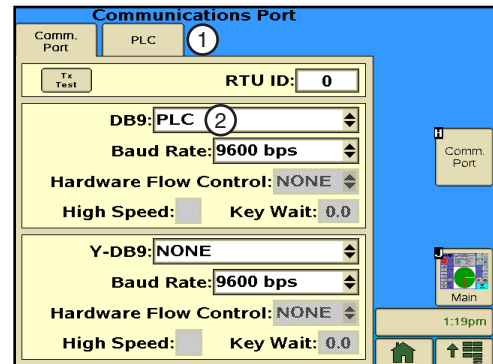

Figure 44-2 1. PLC Accessible
2. PLC Selected

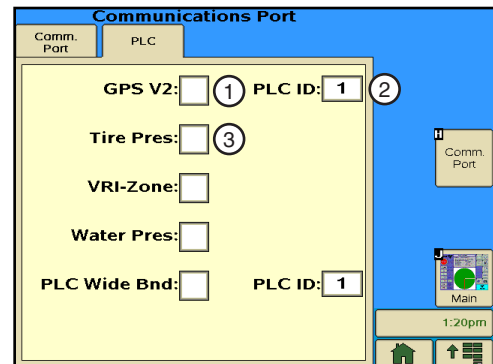

Figure 44-3 1. GPS Version 2 Checkbox
2. PLC (Tower Box) ID Field
3. TPMS Tire Pressure Checkbox

Communications Port

PLC Tab

VRI-Zone

VRI-Zone is used to set the protocol for the VRI-ZONE option.

- The protocol must be set prior to turning on the variable application in Options/VRIA/VRI-Z Map/VRI-Z On-Off.
- Constants and diagnostics for VRI-Zone are available in Options/VRI.

To enable VRI-Zone, follow these steps.

1. Push **Setup, Comm. Port**.
2. Select PLC from the **DB9** drop-down menu.
3. Push the **PLC** tab to display the PLC screen. Refer to Figure 45-1.
4. Check the **VRI Zone** check box to enable.

TPMS Water Pressure

TPMS Water Pressure is used to set the protocol for the End Water Pressure option.

- Constants, diagnostics and data for TPMS are available in Options/TPMS.

To enable TPMS Water Pressure, follow these steps.

1. Push **Setup, Comm. Port**.
2. Select PLC from **the** DB9 drop-down menu.
3. Push **the** PLC tab to display the PLC screen. Refer to Figure 45-1.
4. Check the **TPMS Water Pressure** check box to enable the monitoring system.

PLC Wide Boundary

PLC Wide Boundary is used to set the protocol for the PLC Wide Boundary and GPS Position option. The PLC Wide Boundary tower box contains a GPS antenna.

- PLC Wide Boundary can be used with VRI-Zone as long as there are no more than 14 VRI-Zone boxes (28 zones).
- Enable or disable PLC Wide Boundary 2 and 3 (Wide Boundary 2 and 3), or set start and end angles in Options/Endgun.

To enable PLC Wide Boundary, follow these steps.

1. Push **Setup, Comm. Port, PLC** to display the PLC screen. Refer to Figure 45-1.
2. Check the **PLC Wide Boundary** check box to enable.

The next available tower box ID is displayed. A different ID number can be entered. However, if VRI-Zone is enabled, the PLC ID number cannot be changed. Record Wide Boundary Tower Box ID _____

3. Push **Enter** to retain the value.

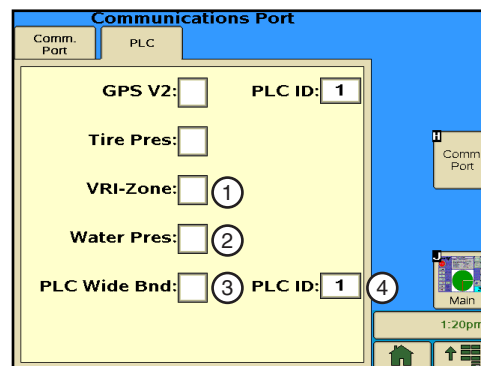

Figure 45-1 1. VRI Zone Checkbox
2. TPMS (End) Water Pressure Checkbox
3. PLC Wide Boundary Checkbox
4. PLC (Tower Box) ID Field

Options Screen

The user can change settings or view information at anytime from the Options screen. The following functions are accessed from the Options screen. Refer to Figure 47-1.

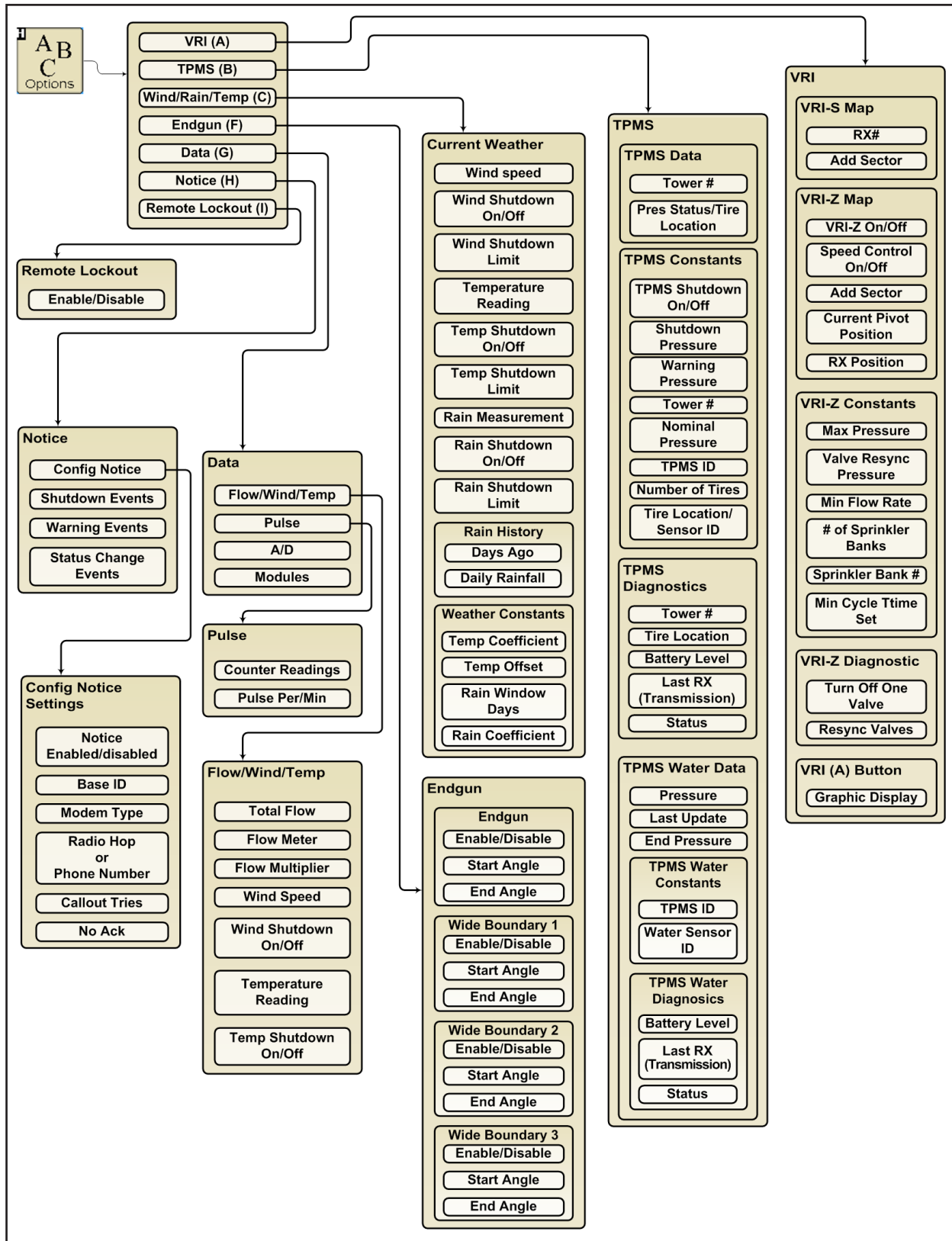

Figure 47-1

Options

Accessing the Options Screen

To access the Options screen, push the **Options** button on the Main screen. Refer to Figure 48-1.

Variable Rate Irrigation (VRI)

VRI Speed Control

The VRI Speed (VRI-S) Control uses mapping software to divide the field into 180 sectors that relate to the sectors on a prescription map. Each sector has a resolution of two degrees.

At periodic intervals, the TouchPro control panel uses the VRI-S prescription along with the current resolver angle, GPS coordinates, or run time to determine and adjust the center pivot speed for each sector.

Example: If the set application of the TouchPro module is 1.00 in. (25.4 mm), and the prescription has a value of 200% in the sector where the center pivot is currently running, the TouchPro module adjusts the speed of the center pivot to achieve an application of 2.00 in (17.78 mm). Center pivot speed cannot exceed 100%.

VRI-S Screen

Use the Options VRI-S screen to enable the Variable Rate Irrigation Speed (VRI-S) control feature, view the prescriptions, and add sectors. **VRI-S is not available when VRI-Z protocol is enabled on the Com Port PLC screen.**

1. Push **Options, VRI** to display the VRI screen. Refer to Figure 48-2.

VRI-S On/Off

To turn the VRI-S feature on or off:

1. Push **Options, VRI**, to display the VRI-S screen. Refer to Figure 48-3.
2. Select the **Rx#** field.
3. Choose an RX (prescription) number to turn VRI-S On, or choose OFF to turn VRI-S OFF.
 - There are five default prescriptions set from 0 to 360 degrees with a depth multiplier of 100%.
 - Other prescriptions can be uploaded to the control panel to replace the default prescriptions. Up to five prescriptions can be stored.

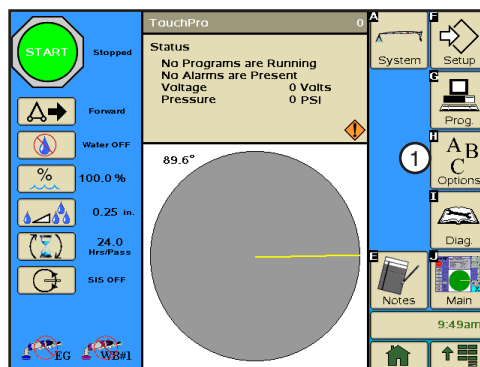

Figure 48-1 1. Options Button

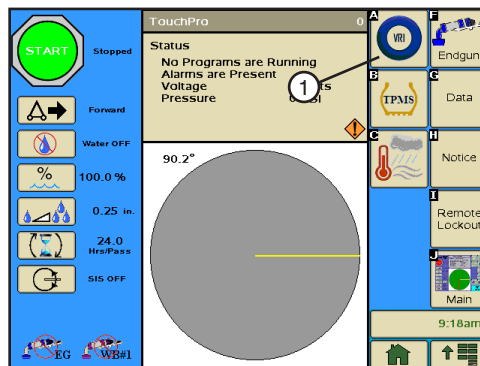

Figure 48-2 1. VRI Button

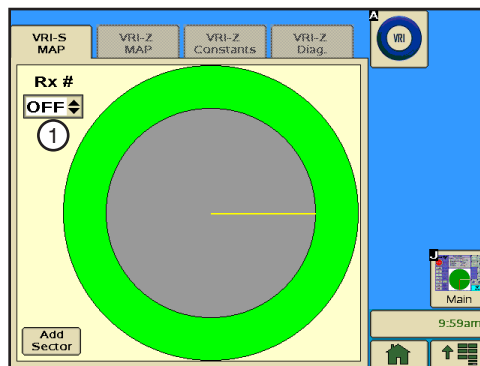

Figure 48-3 VRI Map Screen
1. Rx# Field

VRI Speed Control

NOTE

- When VRI-S is turned on, Cruise Control is automatically disabled.
- The VRI screen functions as a VRI-S control option screen unless VRI-Zone protocol has been enabled.
- When the VRI-Z protocol has been enabled, the VRI screen functions as a VRI-Z Control option screen.

Control Panel Display

Indication that VRI-S is enabled (ON), or running is shown on the control panel Main screen as described below. Refer to Figure 49-1.

- When VRI-S is enabled and ON on the Options screen, *VRI-S" is displayed on the Main screen when water is set to ON.
- VRI is not displayed on the Main screen:
 - » When water is set to OFF, even when a VRI-S prescription is enabled (ON).
 - or
 - » When VRI-S prescription is disabled (OFF).

View Prescription

To view a graphic representation of the prescription % of depth multiplier settings do the following.

1. Push **Options, VRI, VRI-S Map** to display the VRI-S Map screen. Refer to Figure 49-1.
2. Select the **RX#** field.
3. Choose the RX (prescription) number to view the graphic.

A graphic display of the color-coded % of depth multiplier settings are shown for the selected prescription.

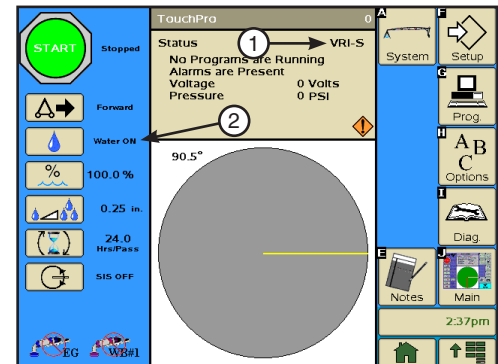

Figure 49-1 1. VRI-S ON Display
2. Water On

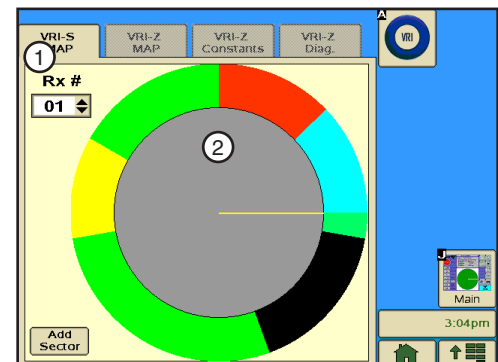

Figure 49-2 1. RX# Field
2. Graphic Display

Options

Add Sector

To change or set sector positions and depth multipliers in any prescription do the following.

1. Push **Options, VRI, VRI-S Map** to display the VRI-S Map screen. Refer to Figure 50-1.
2. Push **Add Sector**.
3. Select the **Rx#** field. Refer to Figure 50-2.
4. Choose the new Rx (prescription) number.
5. Select the **Start Angle** field.
6. Using the numeric keypad, enter the start angle of the sector, and push the **Enter** button.

The start angle value is automatically rounded up to the nearest even number. Example: A start angle of 15° is rounded up to 16°.

7. Select the **End Angle** field.
8. Using the numeric keypad, enter the end angle of the sector, and push the **Enter** button.

The end angle value is automatically rounded up to the nearest even number. Example: An end angle of 85° is rounded up to 86°.

9. Select the **% of Depth** field.
10. Using the numeric keypad, enter the % of depth multiplier (1% to 250%), and push the **Enter** button.

Repeat steps 5 - 9 for any other areas of the field that require different water application rates.

11. Push the **Enter** button to save the changes or push **Cancel** to cancel and exit to VRI-S screen.

If you push the **Enter** button, and you choose the new prescription number in the **Rx#** drop-down menu, a new screen appears. This is the graphical representation of the information you entered in steps 5 - 9. Refer to Figure 50-3.

The table in Figure 49-1 on the following page provides the color key for the **% of Depth** settings available.

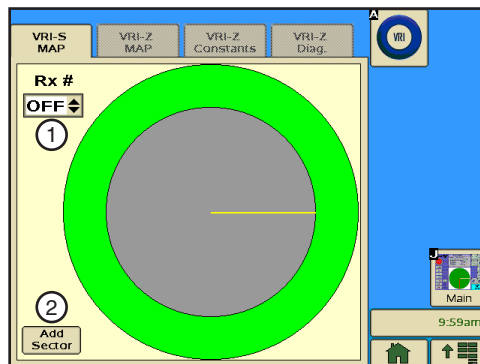

Figure 50-1 1. Prescription Selection Drop-Down Menu
2. Add Sector Button

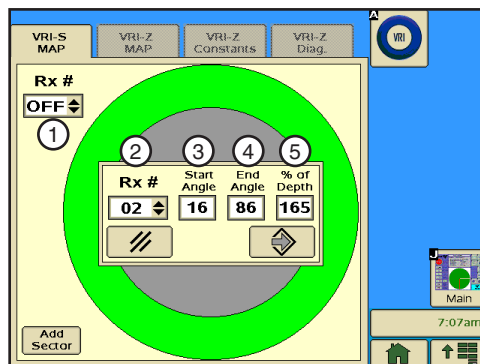

Figure 50-2 1. VRI Speed OFF
2. Rx# Field
3. Start Angle
4. End Angle
5. % of Depth

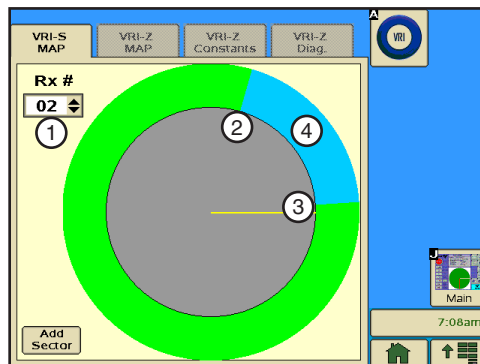

Figure 50-3 1. VRI Speed ON- New Prescription
2. Start Angle - 16°
3. End Angle - 86°
4. 165% of Depth Graphical Representation

Add Sector (continued)

Refer to Figure 51-1 for % of Depth color settings used in graphical VRI-S prescription representations.

























	241-250%						
	231-240%		171-180%		111-120%		51-60%
	221-230%		161-170%		101-110%		41-50%
	211-220%		151-160%		91-100%		31-40%
	201-210%		141-150%		81-90%		21-30%
	191-200%		131-140%		71-80%		11-20%
	181-190%		121-130%		61-70%		1-10%

Figure 51-1

Position Values

VRI-S works with Resolver, GPS, or Runtime Positioning.

- If GPS is not activated, position values are provided by the resolver.
- If GPS is activated, position values are provided by the GPS receiver. When there is no GPS signal, the position resorts to using a backup, either Runtime or Resolver. An E18 error is recorded.

Options

VRI-Zone Control

The VRI-Zone (VRI-Z) Control option uses mapping software and hardware to divide the irrigation machine sprinklers and the field into sectors/sprinkler zones that relate to the sectors on a sprinkler map. Each sector/sprinkler zone has an ID number associated with a VRI tower box valve that controls one or more sprinklers. There can be up to 30 sectors/sprinkler zones.

Each VRI tower box can support up to two sectors/sprinkler zones. Each VRI tower box OEM (Original Equipment Manufacturer) PLC modem card has an ID number. There can be up to 15 VRI tower boxes.

When the TouchPro control panel safety circuit is complete, the OEM PLC Modem Card (OPMC) in each VRI tower box powers up and begins receiving information from the control panel. As the machine runs, each sector/sprinkler zone is pulsed on and off based on its cycle time and percent ON setting (duty cycle).

At periodic intervals, the TouchPro control panel uses the sprinkler map along with the current resolver angle, GPS coordinates, or run time to determine the percent ON for each sector/sprinkler zone. It then sends a set sprinkler messages with the current percent ON for each sector/sprinkler zone along with the current cycle time to the OPMC boards. Set sprinkler messages are sent out at least once every minute without GPS, or once every two minutes with GPS.

NOTE

- When VRI-Zone is turned on, Cruise Control is automatically disabled.
- When VRI-Zone protocol has been enabled (checkbox checked) on the Setup/Comm. Port screen, the VRI screen functions as a VRI-Z Control option screen.

VRI-Z Map

VRI-Zone ON/OFF

After the control panel has been set up, the VRI-Zone option can be turned on or off by doing the following.

1. Push **Options, VRI, VRI-Z Map** to display the VRI-Z Map screen. Refer to Figure 52-1.
2. Select the **VRI-Z** field.
3. Choose **ON** to turn VRI-Z on, or choose **OFF** to turn VRI-Z off.

VRI-Zone Speed Control ON/OFF

The VRI-Zone speed control feature speeds up the machine if, in a given sector, all the duty cycles are less than 100%.

Turn VRI-Zone speed control on or off by doing the following.

1. Push **Options, VRI, VRI-Z Map** to display the VRI-Z Map screen. Refer to Figure 52-1.
2. Select the **Speed Control** field.
3. Choose **ON** to turn Speed Control ON, or choose **OFF** to turn Speed Control OFF.

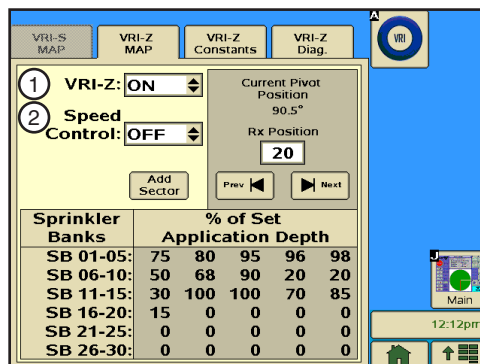

Figure 52-1 VRI-Zone Map Screen
1. VRI-Z ON/OFF
2. VRI-Z Speed Control ON/OFF

VRI-Zone Control Irrigation Prescription

An irrigation prescription is a well thought out plan for applying varying amounts of water to a field. The prescription is created using a computer and the VRI Prescription software. Refer to Figure 53-4.

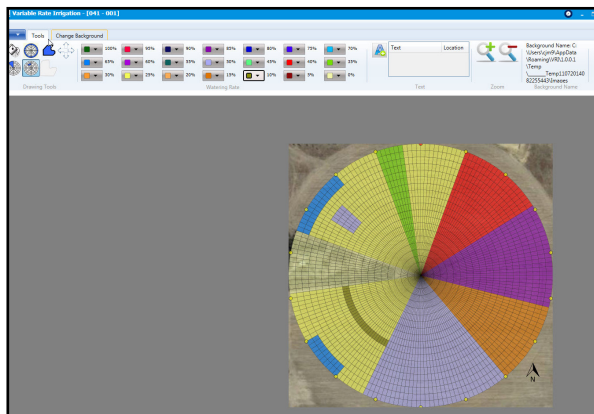

Figure 53-1 Example prescription as shown using VRI Prescription software. The prescription, in graphic form, is not seen on the TouchPro control panel.

The prescription can have up to 30 zones, each with a resolution of 2 degrees. The **Percent On** values in the sprinkler map can be set from 0 to 100 percent in five percent steps.

NOTE

- A good understanding of the overall hydraulics of the center pivot, pipeline, if any, and pump is necessary to ensure equipment is not damaged by shutting off too many zones at once, thereby decreasing flow to less than the minimum flow rate.
- Most pumps experience an increase in Pressure as the flow is decreased. The minimum flow rate must be determined in order to calculate the maximum changes that can be made.
- A variable speed pump is a good option.
- Contact your Valley dealer if you have questions.

Options

VRI-Zone Control View Prescription



To display the duty cycle for each sprinkler zone at a specific position on the map:

1. Push **Options**, **VRI**, **VRI-Z Map** to display the VRI-Z Map screen. Refer to Figure 54-1.

The current pivot position in the field is shown in the Current **Pivot Position** field. In this example, the pivot position is 90.5°.

The prescription position is shown in the **Rx Position** field. In this example, the prescription position being viewed is 20°.

The **% of Depth** setting for each sprinkler bank/zone when the pivot is at the 20° position in the field is displayed at the bottom of the screen.

2. To adjust the viewed position:
 - Select the **Rx Position** field, enter the position in degrees, and push **Enter**or
 - Use the  or  buttons to decrease or increase the viewed position by two degrees.

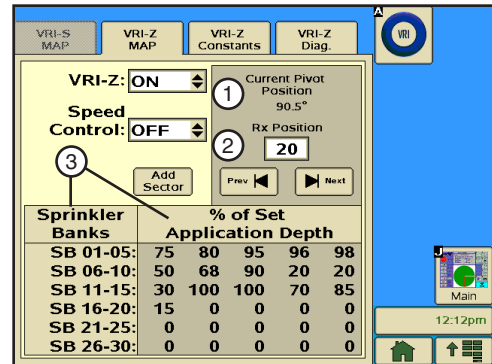

Figure 54-1 1. Current Pivot Position Field
2. Rx Position Field
3. Rx Prescription Sprinkler Bank % of Depth Display

VRI-Zone Control

Prescription Upload Methods

Listed below are products along with several methods for uploading prescriptions to a TouchPro control panel based on the product being used.

- BaseStation2-SM software version 8.3.4 or above (VRI)
- TrackerSP software:
 - » GPRS version 12 (Compatible with VRI software in TouchPro control panels)
 - » CDMA version 15 (Compatible with VRI software in TouchPro control panels)
- VRI Prescription Software including Prescription Loader: Upload or save a prescription created with the VRI prescription software program.
 - » Upload a prescription directly to a TouchPro control panel through a serial cable connection with a personal computer.
 - » Save a prescription to the C:\Program Files\ValleyBase\VRI folder on the computer hard drive for use with BaseStation2-SM.
- BaseStaton2-SM: Access a prescription saved by Prescription Loader to the C:\Program Files\ValleyBase\VRI folder on the computer hard drive for upload to a TouchPro or Select2 control panel through a data radio or phone connection. 300 and 1200 baud radios are not recommended.
- TrackNET web site: Access a prescription created with the VRI prescription software from the C:\VRI\RTU ID folder on the computer hard drive for upload through a wireless connection to a TouchPro control panel with TrackerSP.

Options

VRI-Zone Control

Add Sector

Used to add or change the sector position and duty cycle of the prescription while in the field.

1. Push **Options**, **VRI**, **VRI-Z Map** to display the VRI-Z Map screen. Refer to Figure 56-1.
2. Push **Add Sector**.
3. Select the **Sprinkler Bank #** field, and choose the sprinkler bank number to add. Refer to Figure 56-2.
4. Select the **Start** field.
5. Using the numeric keypad, enter the start angle of the sector. The start angle value is automatically rounded up to the nearest even number. Example: A start angle of 181° is rounded up to 182°.
6. Push **Enter** to retain the value.
7. Select the **End** field.
8. Using the numeric keypad, enter the end angle of the sector. The end angle value is automatically rounded up to the nearest even number. Example: An end angle of 195° is rounded up to 196°.
9. Push **Enter** to retain the value.
10. Select the **% of Depth** field.
11. Using the numeric keypad, enter the % of depth multiplier (0% to 100%), and push **Enter**.
12. Push the **Enter** button to save the changes, or push the **Cancel** button to cancel the entries and exit to VRI-Z screen.

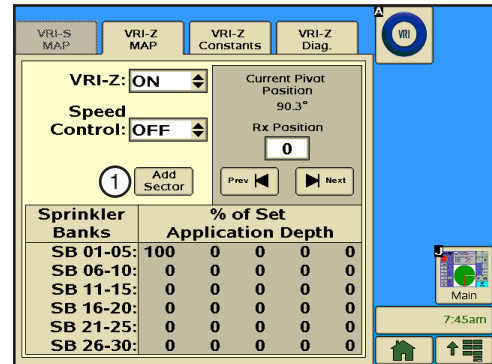

Figure 56-1 1. Add Sector Button

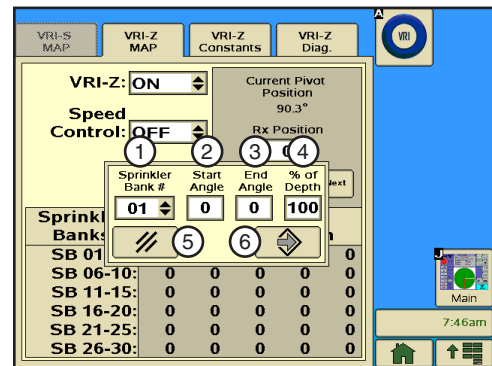

Figure 56-2 1. Sprinkler Bank # Menu
2. Start Angle Field
3. End Angle Field
4. % of Depth Field
5. Cancel Button
6. Enter Button

VRI-Zone Control

VRI-Z Constants

System Shutdown

The TouchPro system monitors the pressure and flow rate. If the system pressure exceeds the maximum system pressure, entered on the VRI-Z Constants tab screen, for three seconds, the system shuts down. Likewise, if the flow rate is less than the user-entered minimum flow rate after the system operating pressure is above the low pressure limit, the system shuts down. A system fault occurs in the event of a shutdown.

Position Values

VRI-Zone Control works with Resolver, GPS, or Runtime Positioning:

- If GPS is not activated, position values are provided by the resolver.
- If GPS is activated, position values are provided by the GPS receiver. But, when there is no GPS signal, the position resorts to using backup, either Runtime or Resolver. An E18, GPS Communications Error is recorded.

Maximum Pressure

The maximum pressure function is used to monitor the water pressure. A high pressure error is recorded if the water pressure reaches the maximum pressure setting. If the water pressure remains at the maximum pressure setting for three seconds, the machine is shut down and an E22, High Pressure error is recorded.

1. Push **Options, VRI, VRI-Z Constants** to display the VRI-Z Constants screen. Refer to Figure 57-1.

The Maximum Pressure (Max Pressure) field displays the current maximum pressure in psi (kPa).

2. To change the maximum pressure limit, select the **Max Pressure** field.
3. Enter the new maximum pressure value. The range is 1-999 psi (kPa). The default is 80 psi (551.5 kPa).
4. Push **Enter** to retain the value.

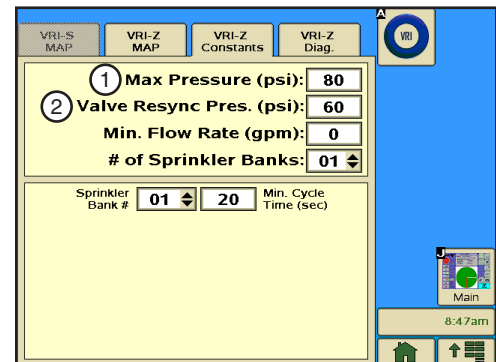

Figure 57-1 1. Maximum Pressure Field
2. Valve Resync Pressure Field

Re-synchronize Valve Duty Cycle

When the valve re-synchronize pressure is reached, the duty cycles of all sprinkler zones starts over. All odd numbered zones start on the OFF part of the cycle, and all even numbered zones start on the ON part of the cycle.

Valve Resync

Valve Resync is used to monitor water pressure, and re-synchronizes the duty cycle of all sprinkler zones. When the valve re-synchronize pressure is reached, the duty cycles of all sprinkler zones start over. All the odd numbered zones start on the OFF part of the cycle, and all even numbered zones start on the ON part of the cycle.

1. Push **Options, VRI, VRI-Z Constants** to display the VRI-Z Constants screen. Refer to Figure 57-1.
The Valve Resync Pressure field displays the current resync pressure in psi (kPa).
2. To change the valve resync pressure, select the **Valve Resync Pressure** field.
3. Enter a new resync pressure value. The range is 1-999 psi (6.90-6887.90 kPa). The default is 60 psi (413.7 kPa).
4. Push **Enter** to retain the value.

Options

VRI-Zone Control

Minimum Flow Rate

The minimum flow rate function is used to monitor the flow rate, and requires the use of an optional flow meter. An E21, Low Flow error is recorded if the flow rate reaches the minimum flow rate setting while the system is above the low pressure setting. If the flow rate remains at or below the low flow rate setting for 15 seconds, the machine is shut down, and a Low Flow system fault is recorded. A Low Flow system fault can only occur if the system is above the low pressure setting, the minimum flow rate feature is on, and a flow meter is installed.

1. Push **Options, VRI, VRI-Z Constants** to display the VRI-Z Constants screen. Refer to Figure 58-1.

The **Min Flow Rate** field displays the current minimum flow rate in gpm (lpm).

2. To change the minimum flow rate, select the **Min Flow Rate** field and enter the new minimum flow rate value. The range is 1-999 gpm (lpm). When set to 0 (zero), the low flow system fault is disabled. The default is 0.
3. Push **Enter** to retain the value.

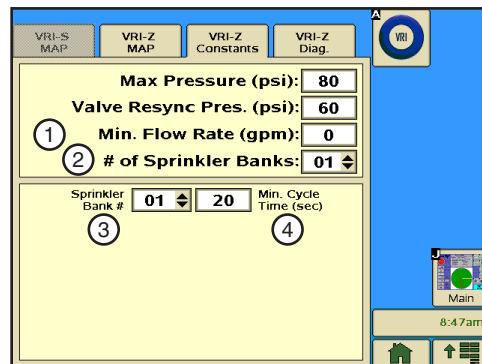

Figure 58-1 1. Min. Flow Rate Field
2. # of Sprinkler Banks Field
3. Sprinkler Bank # Field
4. Min. Cycle Time Field

Sprinkler Banks

The sprinkler banks function is used to set the number of sprinkler zones. This is required so that the control panel knows how many tower boxes it must talk to. For example, If there are 13 sprinkler zones, then the control panel talks to tower boxes with an ID from 1-7.

1. Push **Options, VRI, VRI-Z Constants** to display the VRI-Z Constants screen. Refer to Figure 58-1.
The **# of Sprinkler Banks** field displays the current number of sprinkler banks.
2. To change the number of sprinkler banks, select the **# of Sprinkler Banks** field and choose the number of sprinkler banks for this application. The range is 1-30 sprinkler zones. The default is 1.

Minimum Cycle Time

The minimum cycle time function is used to view and change the sprinkler zone minimum valve cycle time.

1. Push **Options, VRI, VRI-Z Constants** to display the VRI-Z Constants screen. Refer to Figure 58-1.
The minimum cycle time is displayed in seconds for the corresponding sprinkler bank number.
2. To change the minimum cycle time, select the **Sprinkler Bank #** field and choose the sprinkler bank number from the drop-down menu.
3. Select the Min. Cycle Time field, and enter the minimum cycle time value. The range is 1-999 seconds. The default is 20 seconds.
4. Push **Enter** to retain the value.

VRI-Z Diagnostics

Turn Off One Valve

This diagnostic is used to test sprinkler zones for proper operation. This feature turns all sprinkler banks on. Then, it turns the sprinkler bank number entered off.

This setting is maintained for five minutes, or until a different sprinkler bank is commanded off. After five minutes, the control panel resorts back to the programmed settings.

1. Push **Options, VRI** and **VRI-Z Diagnostic** to display the VRI-Z screen. Refer to Figure 59-1.
2. Select the **Sprinkler Bank #** field and choose the sprinkler bank number to turn OFF.
3. Push the **Sprinkler Bank Test** button to begin the test.

Resync Valves

Use Resync Valves to manually re-synchronize the duty cycle of all sprinkler banks.

The duty cycles of all sprinkler banks start over. All odd numbered banks start on the OFF part of the cycle, and all even numbered banks start on the ON part of the cycle.

1. Push **Options, VRI** and **VRI-Z Diagnostic** to display the VRI-Z screen. Refer to Figure 59-1.
2. Push the **Resync Valves** button to re-synchronize.

VRI Button

The VRI button switches the screen to a graphic display of the pivot. Refer to Figure 59-2.

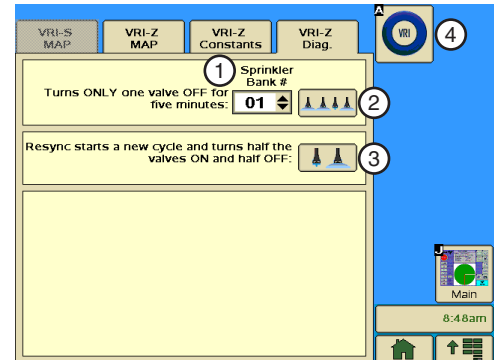

Figure 59-1 1. Sprinkler Bank # Field
2. Sprinkler Test Button
3. Resync Valves Button
4. VRI Button

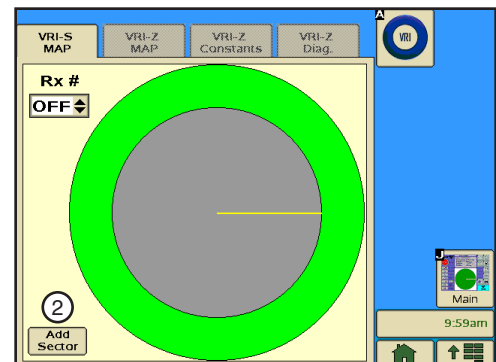

Figure 59-2 Graphic Display

Options

VRI-Zone Overview

The pages in this section provide a brief description of the Valley Variable Rate Irrigation (VRI) components and controls.

VRI Tower Box

Each VRI tower box contains an OEM PLC Modem Card (OPMC) and two solenoid valves. Refer to Figure 60-1.

The TouchPro control panel sends messages to the OPMC that provide the current percent ON for control of each solenoid valve. VRI tower boxes are usually installed on the span pipe close to the drive unit.

Water Filter

The water filter filters water going to the solenoid valves in the tower box. Refer to Figure 60-1.

Each water filter supplies water to both solenoids' valves on one VRI tower box.

Sprinkler Valve

One or more Aquamatic sprinkler valves are opened and closed by one solenoid valve in the VRI tower box. A plastic tube connects each Aquamatic sprinkler valve to a solenoid valve. Refer to Figure 60-2.

The Aquamatic sprinkler valve used in the VRI application does not have a drain.

A typical plumbing configuration for regions where the temperature during the winter months drops below 40°F (4°C), and/or the growing season is six months is shown in Figure 60-2.

- The valve is mounted horizontally which allows water to drain out of the valve and plumbing reducing the possibility of damage due to freezing. Refer to Figure 60-2.
- Other plumbing configurations that might be used in regions where the temperature during the winter months stays above 40°F (4°C) are shown in Figure 60-3.
- The valve is mounted vertically which does not allow water to drain out of the valve or U-pipe. If temperatures drops below 40°F (4°C), turn the VRI option OFF and run the machine with water, this opens the valves (which can be visually inspected) to drain water and reduce the possibility of damage due to freezing. Refer to Figure 60-3.

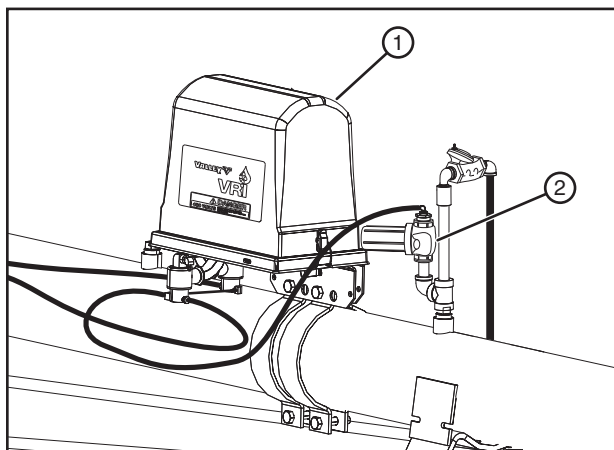

Figure 60-1 1. Aquamatic Valve
2. Plastic Tube

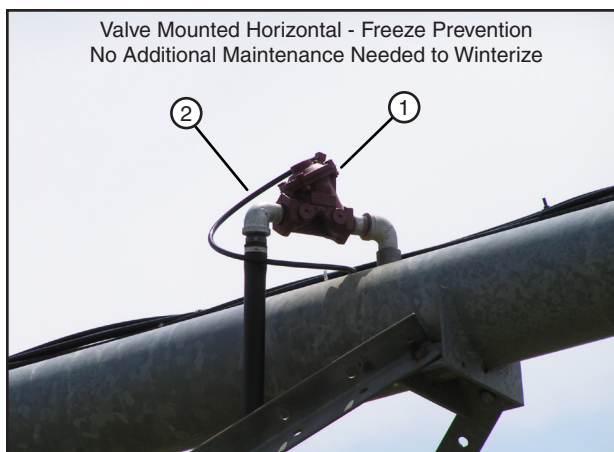

Figure 60-2 1. Aquamatic Valve
2. Plastic Tube

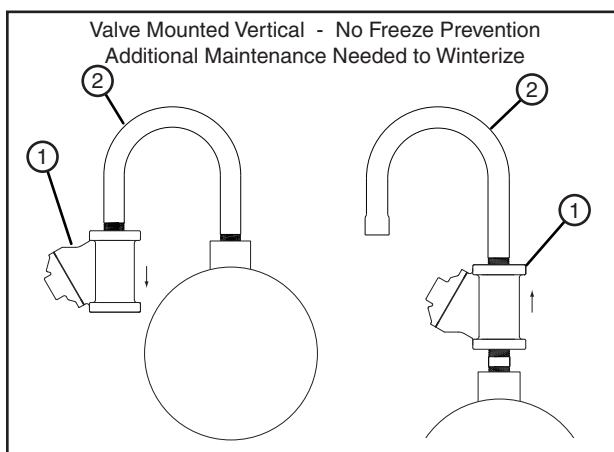

Figure 60-3 1. Aquamatic Valve
2. U-Pipe

VRI-Zone

Overview

Data Port

The Data Port option can be used when uploading a VRI prescription to the TouchPro control panel from a computer running the prescription software. Refer to Figure 61-1.

Stand Pipe Option

The Stand Pipe Option is used to reduce OFF duty cycle lag time in extreme applications where it takes more than a few seconds for sprinkler valves in a specific zone to close. Refer to Figure 61-2.

The ball valve on the bottom of the stand pipe must be closed during operation.

In regions where the temperature during the winter months drops below 40°F (4°C), and/or the growing season is six months or less, drain the stand pipe at the end of season.

NOTE: This option is typically not used in normal applications.

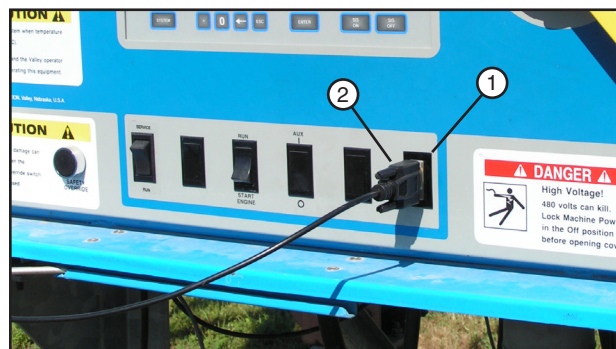

Figure 61-1 1. Data Port
2. Serial Cable

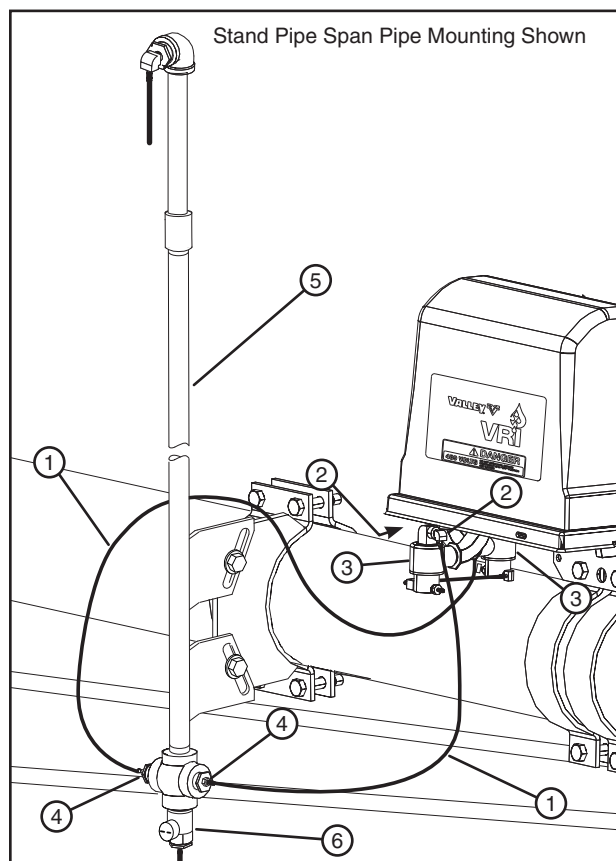

Figure 61-2 1. Plastic Tubing 4. Fitting
2. Exhaust Port 5. Stand Pipe
3. Solenoid 6. Ball Valve

Options

Tire Pressure Monitor System (TPMS)

Use the Options/TPMS screen to view tire pressure data, set tire pressure constants, view results of tire pressure diagnostics, and to view water pressure data, constants, and diagnostics.

Push Options, TPMS to display the TPMS screen. Refer to Figure 62 -1.

TPMS Data Tab

The Tire Pressure Data screen is only available when the TPMS Tire Pressure protocol is enabled in Setup/Comm. Port/PLC. To review tire pressure information, do the following.

1. Push **Options**, **TPMS**, **TPMS Data** for the Tire Pressure Data screen. Refer to Figure 62-2.
2. Select the **Tower #** field, and choose the tower number.
3. Verify the tire pressure readings at each tire position shown (R, MR, M, MF, F). Only tires with a valid sensor ID configured on the tower are shown.
4. View the tire status displays, which can be:
 - OLD - Sensor or TPMS has not responded for two or more hours.
 - LOW - Tire pressure is at or below Warning Pressure value.
 - OK - Pressure is above Warning Pressure value.
 - "- -" - There is no data to show.

TPMS Constants Tab

The TPMS Constants screen is used to set the following constants:

- Shutdown Pressure Drop
- Warning Pressure Drop
- Nominal Pressure
- Sensor Setup

Shutdown Pressure

The system can be set to shut down if tire pressure falls below a certain amount.

1. Push **Options**, **TPMS**, **TPMS Constants** for the Tire Pressure Constants screen. Refer to Figure 62-3.
2. Select the **TPMS Shutdown On/Off** field, and choose **On** to turn TPMS Shutdown ON, or choose **Off** to turn it OFF.

The system default is OFF.

3. If TPMS Shutdown is turned ON, select the Shutdown Pressure field, and enter the pressure value for the pressure drop shutdown.

The system default is 6 psi (41 kPa), and the range is 1 psi (6 kPa) to 15 psi (103 kPa).

4. Push **Enter** to retain the value.

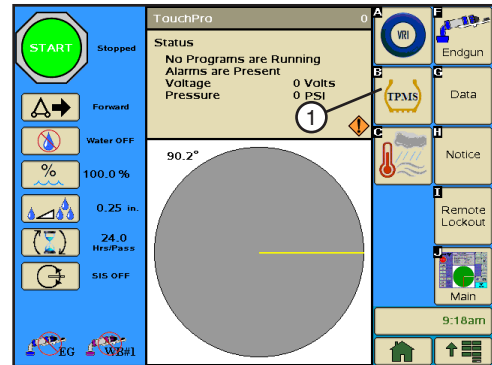

Figure 62-1 1. TPMS Button

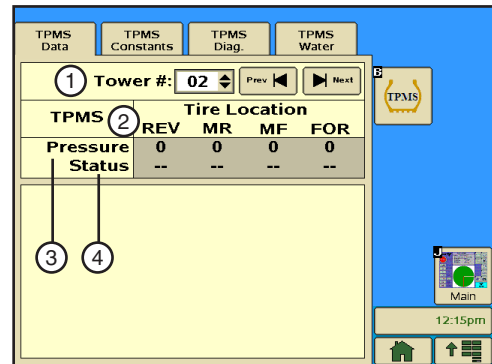

Figure 62-2 1. Tower # Field
2. Tire Locations
3. Tire Pressure Displays
4. Tire Status Displays

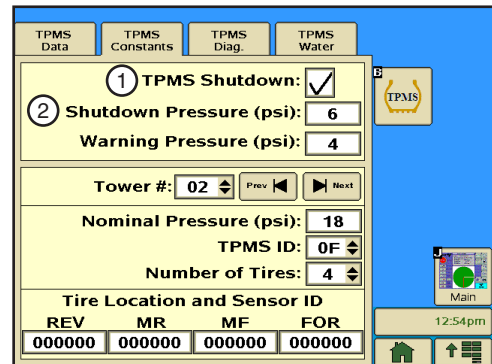

Figure 62-3 1. TPMS Shutdown Checkbox
2. Shutdown Pressure Field
3. Warning Pressure Field

Warning Pressure

A warning can be provided if tire pressure falls below a certain amount.

1. Select the **Warning Pressure** field, and enter the pressure value for the pressure drop warning. Refer to Figure 63-1.
The default is 4 psi (27 kPa), and the range is 1 psi (6 kPa) to 15 psi (103 kPa).
2. Push the **Enter** button.

Nominal Pressure

1. Select the **Tower #** field, and choose the tower number to set up. Tower 1 is the tower closest to the pivot point. The range is 1-18. Refer to Figure 63-1.
2. Select the **Nominal Pressure** field.
3. Using the numeric keypad, enter the recommended inflation pressure value for the tires on this tower. The default is 18 psi (124 kPa) and range is 6 psi (41 kPa) to 37 psi (255 kPa).
4. Push **Enter** to retain the value.
5. Select the **TPMS ID** field.
6. From the drop-down menu, choose the TPMS tower box ID that receives signals from pressure sensors on this tower.
The default ID is 0, and the range is 0-9 and 0A-0F, where 0A = 10, 0B = 11, 0C = 12, 0D = 13, 0E = 14, and 0F = 15.
7. Push **Enter** to retain the value.
8. Select the **Number of Tires** field, and enter the number of tires on this tower. The default number of tires is 2, and the range is 2 - 4.
9. Push **Enter** to retain the value.

Sensor Setup

1. Select the **Tire Location Sensor ID** field. Refer to Figure 63-1.
2. Using the numeric keypad, enter the six-digit tire sensor ID in the specified order for the number of tires selected.
 - Two tires - Enter the reverse (REV) tire sensor ID and the forward (FOR) tire sensor ID
 - Three tires - Enter the reverse tire sensor ID, the mid (M) tire sensor ID, and the forward tire sensor ID
 - Four tires - Enter the reverse tire sensor ID, the mid-reverse (MR) tire sensor ID, the mid-forward (MF) tire sensor ID and the forward tire sensor ID.
3. Push **Enter** after each sensor ID entry.

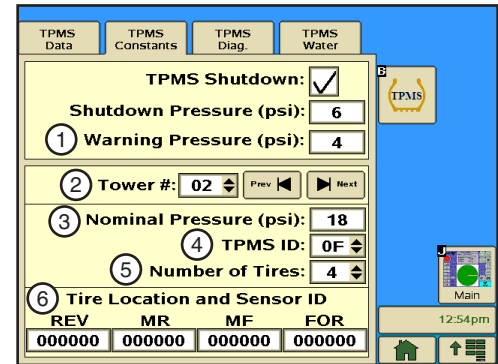

Figure 63-1

1. Warning Pressure Field
2. Tower # Field
3. Nominal Pressure Field
4. TPMS Tower Box ID
5. Number of Tires Menu
6. Tire Location and Sensor ID Field

Options

TPMS Diag Tab

The TPMS Diagnostics screen displays the tire pressure sensor battery level, Minutes Since Last Received update, and a signal acknowledgement.

To view the Tire Pressure Diagnostics screen, do the following.

1. Push **Options**, **TPMS**, **TPMS Diagnostics** for the Tire Pressure Diagnostics screen. Refer to Figure 64-1.
2. Select the **Tower #** field and choose the tower number.
3. Observe the data to make sure all sensors are working correctly. Verify the number of tires on the tower, sensor battery levels, Minutes Since Last Received update, and signal strength.

- Tire positions shown are based on pivot tower sensor setup number of tires (REV, MR, MID, MF, FOR). Only tires with a valid sensor ID configured on the tower are shown.
- Sensor battery level (BAT) is either OK, LOW. or - - (no information)
- Minutes Since Last Received update (LASTRX) is shown, or - - (no information). Update frequency is approximately every two minutes.
- Signal strength (SIGNAL) may display OK, - - (no information), or one of the following:
 - » NA-Not Available: The control panel has not requested data yet.
 - » NR-No Response: While running or waiting, the TPMS box did not respond to last data request.
 - » NS-No Sensor: The sensor never reported to the TPMS box.

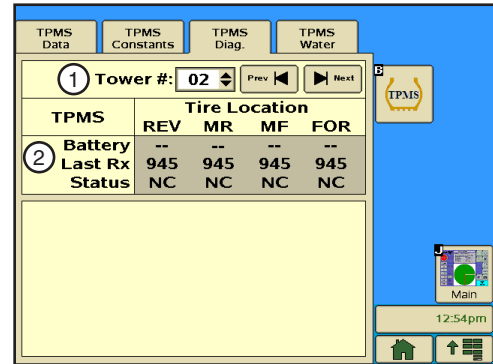

Figure 64-1 1. Tower # Menu
2. Sensor Battery Data

TPMS Water Tab

The TPMS Water screen displays the water TPMS pressure data, the TPMS water sensor IDs, and the TPMS water sensor diagnostics.

1. To view the TPMS Water screen, push **Options, TPMS, TPMS Water** for the TPMS Water screen. Refer to Figure 65-1.

TPMS Water Data

The TPMS Water Data section of the screen provides information about both the water pressure at the pivot and the water pressure at the end of the machine. It also indicates when the last update was made to this information.

1. Observe the data to ensure that the **Pressure** and **End Pressure** levels are acceptable.
2. Observe the number of minutes in the **Last Update** display to ensure that the Water Sensor is operating correctly.

TPMS Water Constants

The TPMS Water Constants section of the screen is used to view or change the TPMS and Sensor ID numbers for the end water pressure monitor.

1. Push **Options, TPMS, TPMS Water Data** for the TPMS Water Data screen. Refer to Figure 65-1.
2. Select the **TPMS ID** field.
3. From the drop-down menu, choose the TPMS tower box ID that receives signals from the water pressure sensor near this tower.
The default ID is 0, and the range is 0-9 and 0A-0F, where 0A = 10, 0B = 11, 0C = 12, 0D = 13, 0E = 14, and 0F = 15.
4. Push **Enter** to retain the value.
5. Select the **Water Sensor ID** field and enter the six-digit water pressure sensor ID.
6. Push **Enter** to retain the value.

TPMS Water Diagnostics

The Water Pressure Diagnostics screen displays the sensor battery level, minutes since last received update, and a signal acknowledgement.

To view the Water Pressure Diagnostics screen, do the following.

1. Push **Options, TPMS, TPMS Water Data** for the TPMS Water Data screen. Refer to Figure 65-1.
2. Observe the data to make sure the sensor is working correctly. Verify the sensor battery level, Minutes Since Last Received update, and signal strength status.

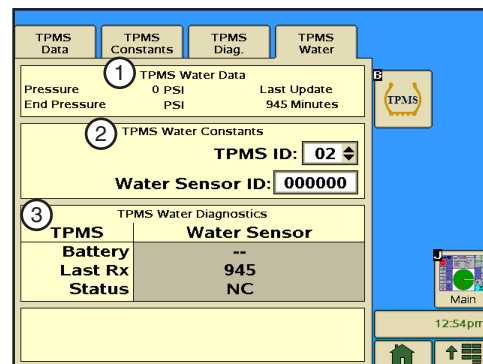

Figure 65-1 1. TPMS Water Data
2. TPMS Water Constants
3. TPMS Water Diagnostics

Options

Weather

The Weather option is used to display wind speed, temperature and rain data, and to view or change the temperature and rain constants. To view the Weather screen, push **Options, Wind/Rain/Temp**. Refer to Figure 66-1.

Current Weather

The Current Weather screen is used to display wind speed, temperature and rain data, and to turn the wind, temperature, and rain shutdowns on or off. Refer to Figure 66-2.

Wind Speed

The wind speed is displayed in miles per hour, or meters per second, depending on if English or Metric units have been enabled.

1. Push **Options, Wind/Rain/Temp, Current Weather** to display the Current Weather screen.
2. View the current wind speed in the **Wind** field.

Wind Shutdown

Wind Shutdown is used to turn the high wind limit shutdown on or off, and to set the high wind speed limit. When the high wind limit shutdown is on, and the high wind limit is reached, the machine stops and a **Wind** fault is logged in the system.

Turning Wind Shutdown On/Off

Check the **Wind Shutdown** checkbox to turn the wind shutdown function On, and uncheck the checkbox to turn the wind shutdown function Off.

Setting High Wind Shutdown Limit

To set the high wind limit, follow these steps.

1. Select the **High Wind Limit** field.
2. Using the numeric keypad, enter the high wind speed limit. The default setting is 15 miles per hour (6.7 meters per second).
3. Push **Enter** to retain the value.

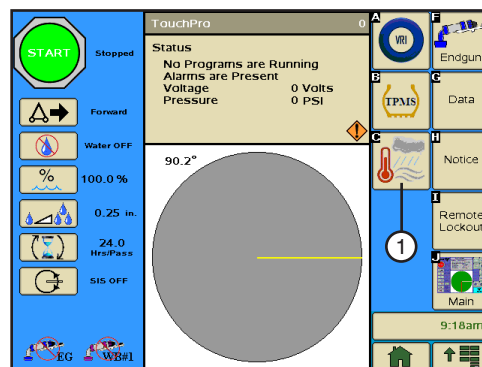

Figure 66-1 1. Wind/Rain/Temp Button

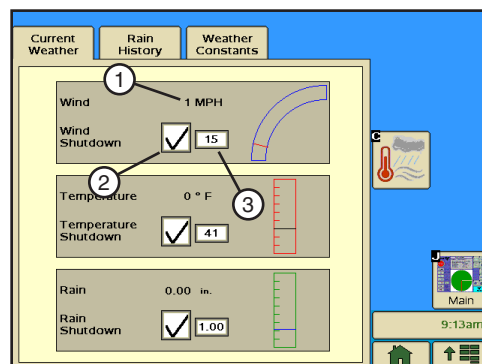

Figure 66-2 1. Wind Speed Field
2. Shutdown Checkbox
3. High Wind Limit Field

Current Weather Temperature

The temperature is displayed as + or - degrees Fahrenheit (F) or Celsius (C), depending on if English or Metric units have been enabled.

1. View the current temperature reading in the **Temperature** field. Refer to Figure 67-1.

Temperature Shutdown

The Temperature Shutdown On/Off function is used to set the temperature below which the irrigation system is shut down, and turn the low temperature limit shutdown on or off. If the low temperature function is on, and the temperature goes below the low temperature limit, the machine stops and a **Temperature** fault is logged in the system. The low temperature limit default value is 41°F (5°C). The minimum value is 14°F (-10°C), and the maximum value is 176°F (80°C).

Turning Temperature Shutdown On/Off

1. Check the **Temperature Shutdown** checkbox to turn the temperature shutdown function On, and uncheck the checkbox to turn it Off.

Setting Low Temperature Shutdown Limit

To set the low temperature limit, follow these steps.

1. Select the **Low Temperature Limit** field.
2. Using the numeric keypad, enter the low temperature limit.
3. Push **Enter** to retain the value.

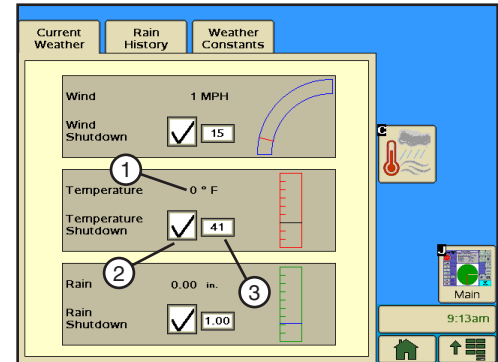

Figure 67-1 1. Current Temperature Field
2. Shutdown Checkbox
3. Low Temperature Limit Field

Options

Current Weather

Rain

The Rain function allows the user to view the current rainfall amount, and to set the amount of rainfall above which the irrigation system is shut down.

Rain Measurement

The rain measurement is displayed in inches or millimeters, depending on if English or Metric units have been enabled.

1. Push **Options**, **Wind/Rain/Temp**, **Current Weather** to display the Current Weather screen to view the current rainfall amount. Refer to Figure 68-1.

Rain Shutdown On/Off

The Rain Shutdown function allows the user to set the amount of rainfall above which the irrigation system is shut down. If the Rain Shutdown function is on, and the total rainfall in the defined window of time goes rain above the shutdown limit, the machine stops and a **Rain** fault is logged in the system

Turning Rain Shutdown On/Off

Check the **Rain Shutdown** checkbox to turn the rain shutdown function On, and uncheck the checkbox to turn it Off.

Setting Rain Shutdown Limit

To set rain shutdown limit, follow these steps.

1. Push **Options** and **Wind/Rain/Temp** to display the Current Weather screen.
2. Select the **Rain Limit** field.
3. Using the numeric keypad, enter the number of inches. Example: 1, ., 5, 0 for 1.50.

The default value is 1.00 inch (25.4 mm). The rainfall is entered and displayed in inches or millimeters, depending on if English or Metric units have been enabled.

4. Push **Enter** to retain the value.

Rain History

The Rain History screen provides a summary of the daily rainfall totals for the current day (0 days ago) and previous days, the number of which is determined by the Rain Windows (days) field on the Weather Constants Screen. Refer to Figure 68-2.

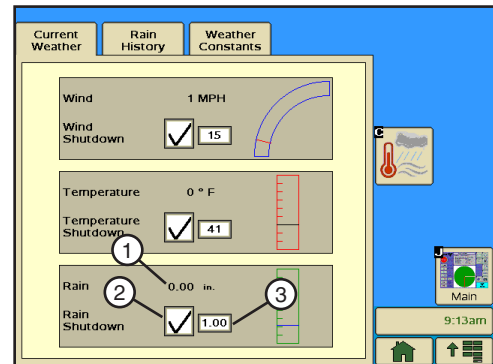

Figure 68-1 1. Rainfall Field
2. Rain Shutdown Checkbox
3. Rain Limit Field

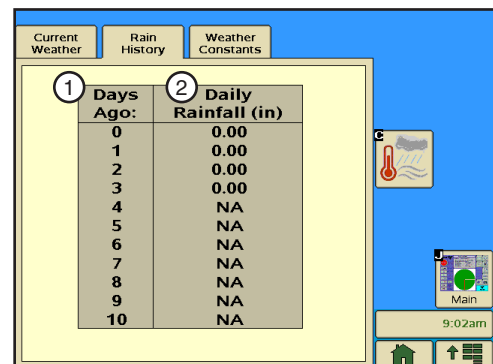

Figure 68-2 1. Days Ago Field
2. Daily Rainfall Field

Weather Constants

The Weather Constants screen contains the constant values used by the Current Weather and Rain History screens to calculate data.

Temperature Coefficient

Push **Options**, **Wind/Rain/Temp**, **Weather Constants** to display the Weather Constants screen. Refer to Figure 69-1.

1. Select the **Temp. Coef.** field.
2. Using the numeric keypad, enter the temperature coefficient. Example: 1, 7, ., 8, 8 for 17.78. Valid values are 0.00 - 99.9 mV/°C. Refer to Figure -9.

If you are using the air temperature sensor provided with the TouchPro, its temperature coefficient has already been set up on the control panel. It is displayed as the default value (17.78) for Temp Coefficient.

If you are using an air temperature sensor other than the one provided, it must be calibrated to work with the TouchPro. Refer to its manufacturer's specifications for the temperature coefficient.

3. Push **Enter** to retain the value.

Temperature Offset

To set the temperature offset, do the following.

1. Select the **Temp Offset** field.
2. Using the numeric keypad, enter the temperature offset. Example: -, 1, 8 for -18. Valid values are -500 - +500. The default value is -18. Refer to Figure -10.
3. Push **Enter** to retain the value.

Rain Window (days)

To set the number of days during which the total rainfall is calculated for use with the Rain Shutdown field on the Weather Constants field, do the following.

1. Select the **Rain Window Days** field.
2. Using the numeric keypad, enter the number of days (0 - 10). Refer to Figure 69-1.
 - Enter 0 days to calculate the amount from midnight to the current time.
 - Enter 1 day to calculate the amount from all of yesterday plus the accumulation from midnight to the current time.
 - A 10-day rainfall history is stored in the system.
3. Push **Enter** to retain the value.

Rain Coefficient

1. Select the **Rain Coefficient** field.
2. Using the numeric keypad, enter the Rain Coefficient Inches per Pulse (Rain Coefficient In/Pulse). Example: 0, ., 0, 1, 0 for 0.010. Refer to Figure 69-1.

Most rainfall sensors are calibrated at 0.010 (factory default). Refer to the sensor manufacturer's specifications for the Rainfall Coefficient Inches per Pulse.

3. Push **Enter** to retain the value.

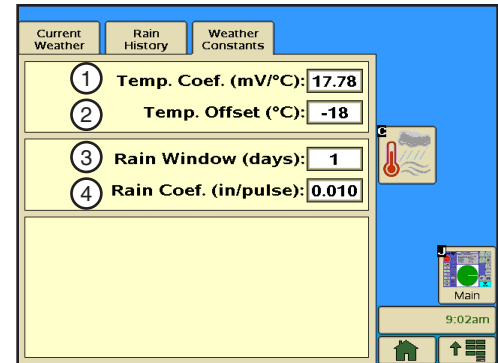

Figure 69-1 1. Temperature Coefficient Field
2. Temperature Offset Field
3. Rain Window Field
4. Rain Coefficient Field

Options

End Gun

Pivot End Gun

Use the End Gun option to enable or disable the first End Gun, Wide Boundary, PLC Wide Boundary #2, and PLC Wide Boundary #3 options. Enabling or disabling any of these options does not affect the programmed constants.

Push **Options**, **Endgun** to display the End Gun/Wide Boundary screen. Refer to Figure 70-1.

End Gun Enable/Disable

To enable or disable an End Gun, push the **End Gun** button to enable or disable the end gun. Refer to Figure 70-2.

Wide Boundary Enable/Disable

To enable or disable the Wide Boundary, push the **Wide Bnd 1** button.

PLC Wide Boundary 2 Enable/Disable

To enable or disable the PLC Wide Boundary 2, push the **Wide Bnd 2** button.

PLC Wide Boundary 3 Enable/Disable

To enable or disable the PLC Wide Boundary 3, push the **Wide Bnd 3** button.

NOTE

- PLC Wide Boundary #2 and #3 are only available when PLC WIDE BND is enabled on the Setup, Comm Port, Comm Port Protocol PLC screen.

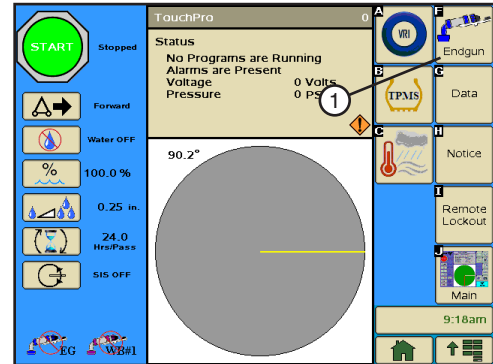

Figure 70-1 1. End Gun Button

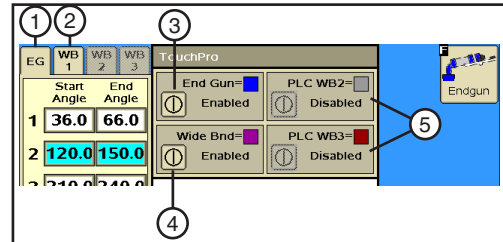

Figure 70-2 1. End Gun Tab
2. Wide Boundary Tab
3. End Gun Enable/Disable Button
4. Wide Boundary 1 Enable/Disable Button
5. PLC Wide Boundary 2 & 3 Enable/Disable Button

End Gun

End Gun Sequences

A pivot can have up to 9 end gun sequences, numbered 1 through 9. Each sequence consists of a start angle and an end angle. The wedge between the start and end angle is where the end gun turns on.

The end gun sequence number does not affect when the end gun turns on or off. The end gun turns on or off based on the start angle and end angle entries. Refer to Figure 71-1.

End gun sequences operate the same whether or not the machine is running in the forward or reverse direction.

- In the FORWARD direction, the end gun turns ON at the start angle and OFF at the end angle.
- In the REVERSE direction, the end gun turns ON at the end angle and OFF at the start angle.

Angles can be entered in tenths to fine tune the end gun setting. For example, an angle can be input as 300.6°. However, 300.6° is displayed as 300° on the Main screen.

Typical Pivot End Gun Settings

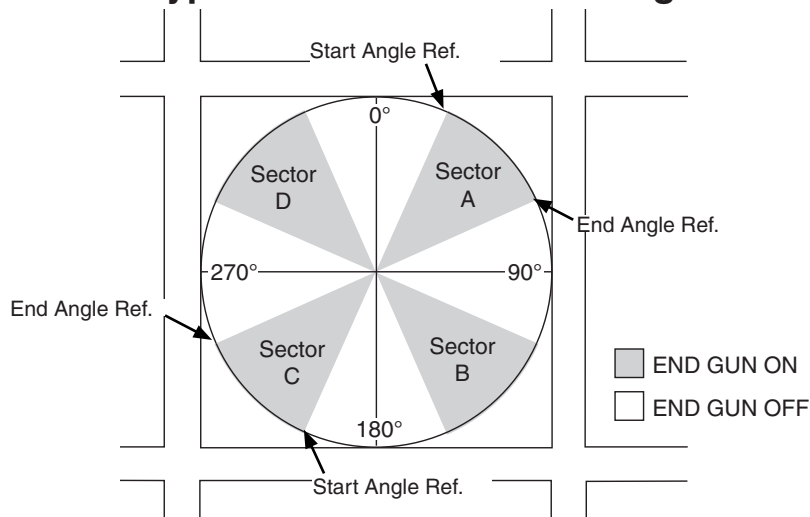

Figure 71-1

Listed below are typical end gun settings for a pivot, based on the field size and end gun being used. Note that the pivot sectors are based on the location of 0° in relation to the pivot. Refer to Figure 71-1 and the End Gun Settings table below it.

NOTE

•These End Gun settings are approximate, and vary for different fields.

NUMBER OF ACRES	END GUN	SECTOR A		SECTOR B		SECTOR C		SECTOR D	
		START ANGLE	END ANGLE	START ANGLE	END ANGLE	START ANGLE	END ANGLE	START ANGLE	END ANGLE
40	NELSON 100	31	59	121	149	211	239	301	329
40	RAINBIRD 85	27	63	117	153	207	243	297	333
160	NELSON 100	21	69	111	159	201	249	291	339
160	RAINBIRD 85	18	72	108	162	198	252	288	342
640	NELSON 100	16	74	106	164	196	254	286	344
640	RAINBIRD 85	13	77	103	167	193	257	283	347

Options

End Gun

Setting Pivot End Gun Sequence

To set end gun sequences, follow these steps.

1. Push **Options**, **Endgun**, **EG** to display the End Gun screen. Refer to Figure 72-1.
2. Select the Start Angle field of a sequence number to modify, and enter the start angle. The angle can be input in tenths of a degree.
3. Push **Enter** to retain the value.
4. Select the End Angle field of the sequence number and enter the end angle. The angle can be input in tenths of a degree.
5. Push **Enter** to retain the value.
6. Repeat steps 2 - 7 to set other sequences.

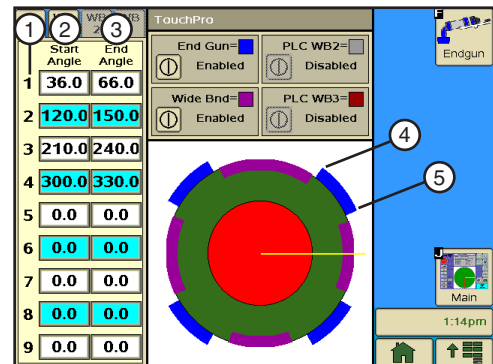

Figure 72-1 1. Sequence Number
2. Start Angle Field
3. End Angle Field
4. 36° End Gun Start Angle
5. 66° End Gun End Angle

End Gun

Wide Boundary

Wide Boundary #1 and PLC Wide Boundary #2 and #3 can be used to control a corner machine sprinkler sequence, a second end gun, a span of sprinklers, or other electrically controlled devices with a voltage of 120 VAC that does not exceed a continuous load current of 2 amps maximum.

Wide Boundary On/Off Sequences

Wide Boundary sequences are numbered 1 through 9. Each sequence has a start angle and an end angle. The wedge between the start and end angle is where Wide Boundary is turned on. The wide boundary sequence number does not affect when the wide boundary turns on and off. Wide Boundary turns on and off based on the start angle and end angle entries.

Wide boundary sequences operate the same whether or not the machine is running in the forward or reverse direction through a sequence.

- In FORWARD, Wide Boundary turns on at the start angle and off at the end angle. Refer to Figure 73-1.
- In REVERSE, Wide Boundary turns on at the end angle and off at the start angle.

Angles can be entered in tenths to fine tune the wide boundary setting. However, an angle of 300.6° is displayed as 300° on the screen.

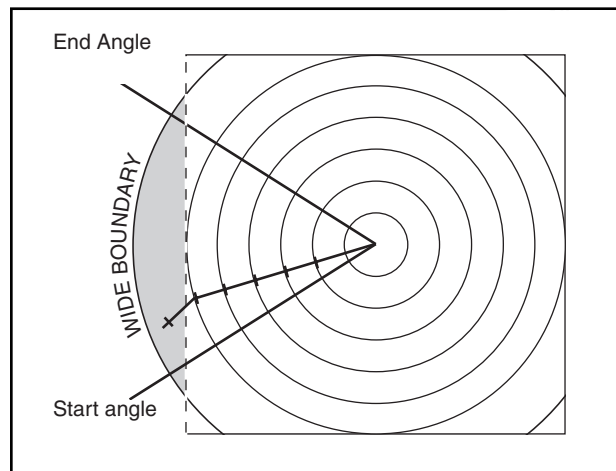

Figure 73-1

Options

Setting Wide Boundary Sequences

To set Wide Boundary sequences, follow these steps.

NOTE

- PLC Wide Boundary #2 and #3 are only available when PLC Wide Boundary is enabled in Setup/Comm Port/Protocol/PLC screen.
- To use PLC Wide Boundary #2 or #3, the machine must be equipped with a PLC wide boundary tower box.
- The desired Wide Boundary must be enabled in the Options/Endgun screen.

1. Push **Options, Endgun, WB1** to display the Wide Boundary screen. Refer to Figure 74-1.
2. Select the **Start Angle** field of a sequence number to modify and enter the start angle. The angle can be input in tenths of a degree.
3. Push **Enter** to retain the value.
4. Select the **End Angle** field of the sequence number and enter the end angle. The angle can be input in tenths of a degree.
5. Push **Enter** to retain the value.
6. Repeat steps 2 - 7 to set other sequences.

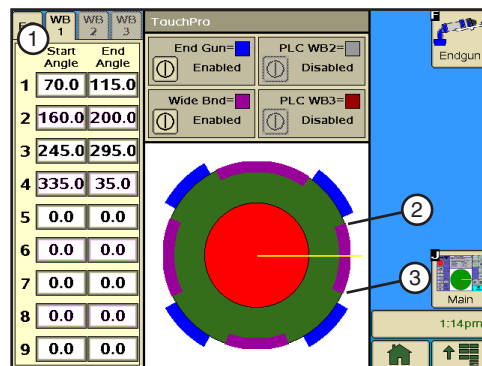

Figure 74-1 1. Wide Boundary (WB) Start and End Angles
2. 70° Wide Boundary Start Angle
3. 115° Wide Boundary End Angle

Data

The Data option is used to review machine information collected by the control panel. Push **Options**, **Data** to display the Data screen. Refer to Figure 75-1.

There are four data types available.

- FLOW/WIND/TEMP - Review the total flow volume and rate of flow when the flow meter option is installed. Review wind speed when the wind meter option is installed. Review the temperature when the temperature sensor option is installed.
- PULSE - Review electrical pulse counters and rates.
- A/D - Review analog to digital voltages for troubleshooting.
- MODULES - Review the status of selected relays. A relay is considered a module.

Flow/Wind/Temp

Flow/Wind/Temp provides flow meter, wind speed, and temperature information from the Flowmeter, Wind, and Temp options. Refer to Figure 75-2.

- Total flow is displayed in millions of gallons, or cubic meters.
- Flow rate is displayed in gallons per minute, or liters per second.
- Wind speed is displayed in miles per hour, or meters per second.
- Temperature is displayed in degrees (°F or °C).

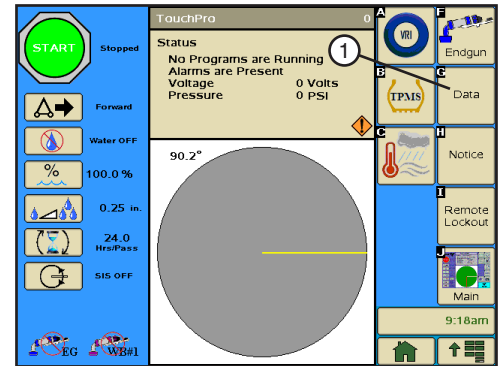

Figure 75-1 1. Data Button

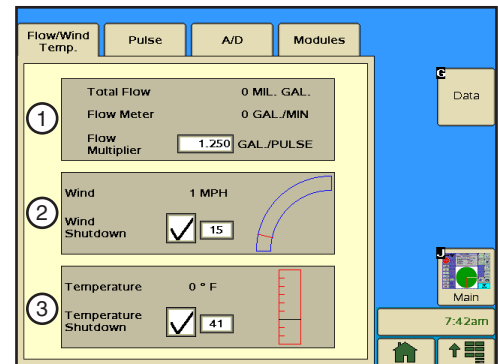

Figure 75-2 1. Flow Meter Information
2. Wind Speed Information
3. Temperature Information

Options

Data

Reviewing Flow/Wind/Temp

To review Flow/Wind/Temp information, push **Options**, **Data**, **Flow/Wind/Temp**. Refer to Figure 76-1.

Total Flow

This is the total amount of water that has flowed through the flow meter, displayed in millions of gallons, or cubic meters.

Flow Meter

This amount is the rate of flow through the flow meter, displayed in gallons per minute, or liters per second.

Flow Multiplier

Flow Multiplier calibrates the control panel with the optional flowmeter. Flow Multipliers (pulse multiplier values) are usually provided by the flowmeter manufacturer. The table below lists multiplier values for Valmont-supplied flow meters. Refer to Figure 76-2.

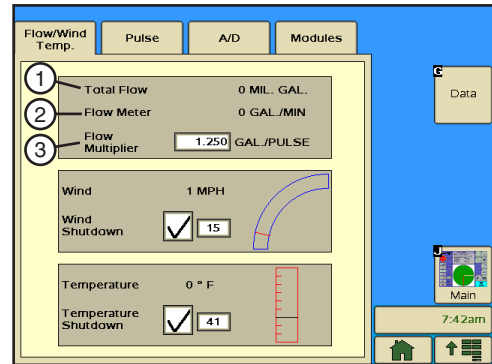

Figure 76-1 1. Total Flow
2. Flow Meter
3. Flow Multiplier

Pipe Diameter (inches)	Gallons per Pulse Typical Values	Liters per Pulse	Max. GPM/RPM	Max. LPS/RPM
6	0.6250	2.366	1300/2080	82.02/2080
6-5/8	0.7407	2.804	1300/1755	82.02/1755
8	1.2500	4.732	2500/2000	157.72/2000
8-5/8	1.3514	5.116	2500/1850	157.82/1850
10	1.9231	7.280	3000/1560	189.27/1560

Figure 76-2 Valmont Supplied Flow Meter Multiplier Values

Setting the Flow Multiplier

To set Flow Multiplier, follow these steps. Refer to Figure 76-1.

1. Select the **Flow Multiplier** field.
2. Using the numeric keypad, enter the manufacturer's recommended pulse multiplier value in either gallons per pulse or liters per pulse, depending on the unit of measure.
3. Push **Enter** to retain the value.

Data

Wind Speed

The wind speed is displayed in miles per hour, or meters per second, depending on if English or Metric units have been enabled. Refer to Figure 77-1.

1. View the current wind speed in the **Wind** field.

Wind Shutdown

Wind Shutdown is used to turn the high wind limit shutdown on or off, and to set the high wind speed limit. When the high wind limit shutdown is on, and the high wind limit is reached, the machine stops and a **Wind** fault is logged in the system.

Turning Wind Shutdown On/Off

Check the **Wind Shutdown** checkbox to turn the wind shutdown function On, and uncheck the checkbox to turn the wind shutdown function Off.

Setting High Wind Shutdown Limit

To set the high wind limit, follow these steps.

1. Select the **High Wind Limit** field.
2. Using the numeric keypad, enter the high wind speed limit. The default setting is 15 miles per hour (6.7 meters per second).
3. Push **Enter** to retain the value.

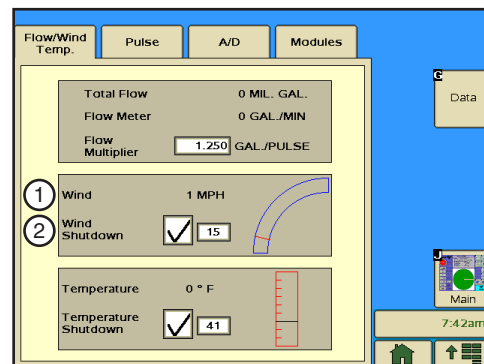

Figure 77-1 1. Wind Speed
2. Wind Shutdown Speed

Options

Data

Temperature

The temperature is displayed as + or - degrees Fahrenheit (F) or Celsius (C), depending on if English or Metric units have been enabled.

1. View the current temperature reading in the **Temperature** field. Refer to Figure 78-1.

Temperature Shutdown

The Temperature Shutdown On/Off function is used to set the temperature below which the irrigation system is shut down, and turn the low temperature limit shutdown on or off. If the low temperature function is on, and the temperature goes below the low temperature limit, the machine stops and a **Temperature** fault is logged in the system. The low temperature limit default value is 41°F (5°C). The minimum value is 14°F (-10°C), and the maximum value is 176°F (80°C).

Turning Temperature Shutdown On/Off

1. Check the **Temperature Shutdown** checkbox to turn the temperature shutdown function On, and uncheck the checkbox to turn it Off.

Setting Low Temperature Shutdown Limit

To set the low temperature limit, follow these steps.

1. Select the **Low Temperature Limit** field.
2. Using the numeric keypad, enter the low temperature limit.
3. Push **Enter** to retain the value.

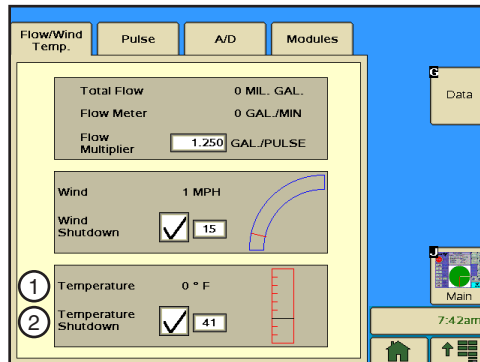

Figure 78-1 1. Temperature
2. Temperature Shutdown

Data

Pulse

Pulse is used to review pulse counts from external equipment. There are five Pulse Channels (PCs), numbered 0 through 4, to count electrical pulses from external equipment. Refer to Figure 79-1.

- Channel 0 (PC0) is reserved for the Flow Meter option. The flow meter propeller produces a certain number of electrical pulses per gallon, or liter. Example: 1.250 pulses per gallon.
 - » Counter Reading for channel 0 counts and totals the electrical pulses from the flow meter. This value is converted to millions of gallons, or cubic meters, and is displayed as **Total Flow** on the Flow/Wind/Temp screen.
 - » Pulses Per Minute for channel 0 provides the rate of pulses from the flow meter in pulses per minute. This value is converted to gallons per minute, or liters per second, and is displayed as **Flow Meter** on the Flow/Wind/Temp screen.
- Channel 1 (PC1) is reserved for the Wind Speed Indicator option. The wind speed pulses are provided by an anemometer. Two pulses are recorded for each turn of the anemometer.
 - » Counter Reading for channel 1 counts and totals the electrical pulses from the anemometer. This value is NOT converted or displayed on the Flow/Wind/Temp screen.
 - » Pulses Per Minute for channel 1 provides the rate of pulses from the anemometer in pulses per minute. This value is converted to miles per hour, or meters per second, and is displayed as **Wind** on the Flow/Wind/Temp screen.
- Channels 2 through 4 are for expansion purposes.

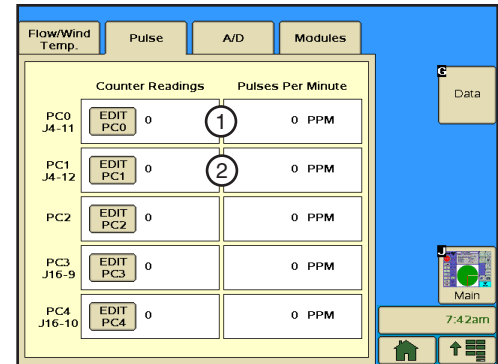

Figure 79-1 1. Flow Meter
2. Wind Speed Indicator

Review and Edit Counter Readings

To review or edit counter readings, do the following.

1. Push **Options, Data, Pulse** to display the pulse screen. Refer to Figure 79-1.
2. Review the counter readings, or edit a counter number to set the count by pushing the **Edit** button.

Options

Data

A/D - Analog to Digital Voltages

A/D is used to review analog voltages. There are twelve analog channels, numbered 0 through 11, to monitor voltage feedback. Refer to Figure 80-1.

- Channels 0 and 1 (AD0 & AD1) monitor two voltage signals from the resolver located in the collector ring. These voltages change as the pivot moves, and are used to calculate the position of the pivot in degrees. The voltage readings should be between 0 and 5000 mV.
- Channel 2 (AD2) monitors voltage from the temperature sensor. This value varies, as the temperature increases and decreases, between 0 and 5 volts.
- Channel 3 (AD3) monitors voltage from the pressure transducer. This voltage varies as pressure increases and decreases, and it is converted into a pressure reading in either pounds per square inch (psi) or kilopascals (kPa). This voltage varies between approximately 1000 mV [0 psi. (0 kPa.)] and 4000 mV [200 psi. (1387 kPa.)].
- Channel 4 (AD4) monitors machine voltage. This value varies as the voltage to the machine varies from the power source.
- Channel 5 (AD5) displays one half of the voltage available to the Pressure transducer. The voltage should always be around 2500 mV.
- Channel 6 (AD6) displays resolver bias reference voltage. The voltage should be around 2500 mV.
- Channel 7 through 11 (AD7 - AD11) are not currently used, but may display random values which should be ignored.

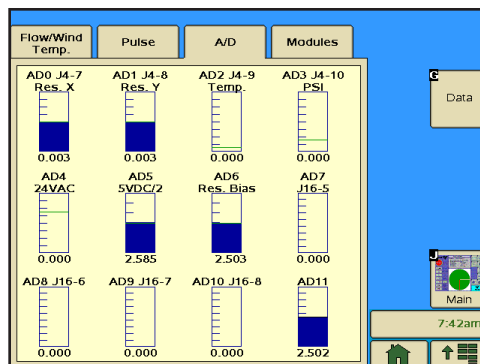

Figure 80-1 Analog to Digital Voltages

Reviewing A/D

To review analog voltages, push **Options**, **Data**, **A/D** to display the Data screen. Refer to Figure 80-1.

Data

Modules

The Modules screen is used to review the condition of, and control all input and output relays used to monitor and control the machine. Refer to Figure 81-1.

Module is another name for a relay. The machine is controlled by a series of relays located in the control panel. Each relay is either closed (ON) or open (OFF) as the machine is operating.

Controlling Modules

You can control an individual relay in the control panel from the Modules screen by selecting it from the **Output Modules** drop-down menu and pushing the **ON** button or the **OFF** button.

Reviewing Modules

You can review the status of an individual module in the control panel by selecting it from the **Input Modules** drop-down menu. The input **Status** field will display either ON or OFF.

To review module relays, do the following:

1. Push **Options, Data, Modules** to display the Modules screen.
2. Select the Module field and choose the Module to review.

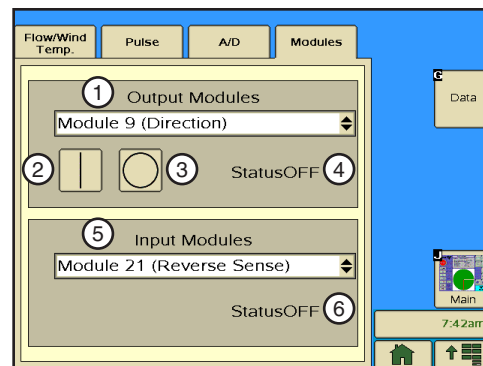

Figure 81-1 1. Output Control Modules
2. On Button
3. Off Button
4. Module Status
5. Input Status Modules
6. Module Status

Options

Data Modules

Reviewing Modules (continued)

The table in Figure 82-1 contains the list of modules whose status can be reviewed from this screen.

MODULE NUMBER	RELAY NUMBER	FUNCTION DESCRIPTION	RELAY BOARD TERMINAL
OUTPUT MODULES			
0	K1	Safety Out	J5-1
1	K2	Percent Timer	J5-2
2	K7	End Gun	J13-5
3	K8	Wide Boundary	J13-6
4	K6	Pump Safety	J13-1, 2, 3
5	K9	Alarm	J6-1, 2, 3
6	K12	Auxiliary 1 Output	J7-1, 2
7	K13	Auxiliary 2 Output	J7-3, 4
8	K4	Contactora Enable	J5-5, 6
9	K3	Direction (Forward=ON, Reverse=OFF)	J5-3, 4
10	D03	Control Panel Backlight	J15-5
11	D02	TTL Output 2	J15-4
12	D01	TTL Output 1	J15-3
13	R01	Low Side 1	J15-1
14	R02	Low Side 2	J15-2
15		Not Used	
INPUT MODULES			
16		Remote Start	J6-5
17		Pressure	J6-4
18	K5	3 Second timer	
19	K15	Auxiliary 2 Input	J7-7, 8
20	K14	Auxiliary 1 Input	J7-5, 6
21	K10	Reverse Sense	J5-4
22	K11	Forward Sense	J5-3
23	K5	Safety Sense	J5-7
24		PC4	J16-9
25		PC5	J16-10

Figure 82-1 Modules and Their Relays

Notice (Event Callout)

Use Notice Callout to configure communications and enable event notification for the real-time update feature, where the control panel is able to transmit a notice that its status has changed. This provides the BaseStation with status information at the time that the change occurs, rather than requiring the BaseStation to request it at a later time. Refer to Figure 83-1.

Notice Event Callout is grouped according to event types, which are shutdown, warning, and operational status changes.

TouchPro Constants and Com Port communications must be configured, and Options/Notice/Events must be enabled before real-time updates notify the BaseStation that the status has changed.

To use real-time updates:

1. The TouchPro module software must be version 9.02 or later.
2. The following Constants and Com Port communications must be configured, based on the method of communication with the BaseStation.
 - » Protocol for the selected Com Port must be set to Remote Control.
 - » Baud Rate
 - » Hardware Flow Control
 - » Key Wait
 - » Configuration Notice:
 - » Base ID
 - » Modem Type
 - » Radio Hop or Phone Number
 - » Callout Tries
 - » Notice checkbox must be enabled.
3. Selected TouchPro Options Notice Events must be enabled.
4. The BaseStation software must be BaseStation2, version 6.0 or later.
5. If a radio is used, it must be set to monitor channel busy information.
6. The radio and modem hardware must support the flow control signals in order to use the Clear To Send (CTS) or Data Carrier Detect (DCD) settings.
7. Reprogramming the radio with modifications, or replacing the modem and harness may be necessary. Contact your Valley dealer for more information.

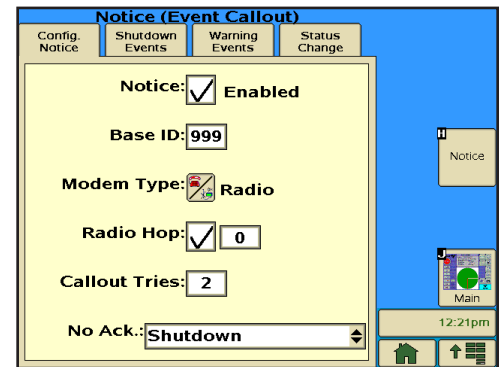

Figure 83-1 Configuration Notice Screen

Options

Notice Callout

Event Notification

There are three Event Notification groups:

- Shutdown - defined as unplanned shutdowns.
- Warning - defined as unstable operating conditions.
- Status Change - defined as locally controlled events that the BaseStation needs to be aware of.

The default state for all event notifications is DISABLED. When an event is enabled and the event occurs, a real-time update is sent from the control module to the BaseStation when the radio channel is clear. On the BaseStation main window, the user is notified that there has been a real-time update. Alarms may be triggered, depending on the configuration of the alarms for the machine.

Enabling or Disabling Events

Enable or disable notification to the BaseStation for only selected events, if the event should occur.

Shutdown Events

To enable or disable notification to the BaseStation2 for the listed system fault events, do the following.

1. Push **Options, Notice, Shutdown Events** to display the Shutdown Events screen. Refer to Figure 84-1.
2. Enable any of the following events by checking the associated checkbox, or disable by unchecking the associated checkbox.
 - SAFETY fault - The safety circuit opens for longer than three seconds.
 - PRESSURE fault - The system pressure drops below the low-pressure limit for longer than 30 seconds.
 - VOLTAGE fault - Voltage drops below the low-voltage limit for longer than 15 seconds.
 - WIND fault - Wind speed increases above the high wind speed limit for longer than one minute.
 - RELAY COM fault - Relay communications drop out, causing the machine to shut down.
 - TIRE PRESSURE (TPMS) fault - Machine stops due to power outage. A real-time update is sent when power is restored.

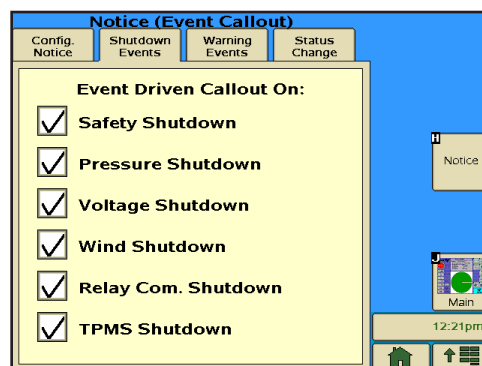

Figure 84-1 Shutdown Events Screen

Notice Callout Events (continued) Warning Events

To enable or disable notification to the BaseStation2 for the listed events, do the following.

1. Push **Options, Notice, Warning Events** to display the Warning Events screen. Refer to Figure 85-1.
2. Enable any the following events by checking the associated checkbox, or disable by unchecking the associated checkbox.
 - SAFETY - Safety is interrupted more than 2 times in a 30 second period. (The system does not lose safety long enough to trigger a fault).
 - PRESSURE - Pressure drops below the low-pressure limit more than 2 times in a 30 second period. This feature is not active until after the low-pressure delay timer has expired. (The pressure is not below the low-pressure limit long enough to trigger a fault).

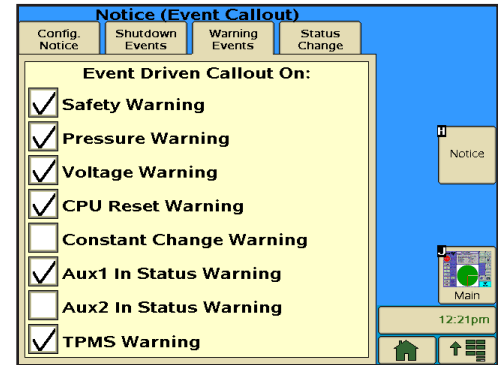

Figure 85-1 Warning Events Screen

- VOLTAGE - Voltage drops below the low-voltage limit more than 2 times in a 30 second period. (The voltage is not below the low-voltage limit long enough to trigger a fault).
- CPU RESET - The TouchPro module's computer is reset, and it's operating system restarts.
- CONSTANT CHANGE - Certain system constants were modified. These constants are SIS, END-GUN, PRES DLY, LOW PRES, MIN APP, HRS/REV, WIDE BND, and AR/AS
- AUX1 IN STATUS - Auxiliary input #1 changes state.
- AUX2 IN STATUS - Auxiliary input #2 changes state.
- TIRE PRESSURE (TPMS) - Tire pressure drops below the low-tire-pressure limit.

Options

Notice Callout Events (continued)

Status Change Events

To enable or disable notification to the BaseStation2 for the listed events, do the following.

1. Push **Options, Notice, Status Change Events** to display the Status Change Events screen. Refer to Figure 86-1.
2. Enable any the following notifications by checking the associated check box, or disable notifications by unchecking the associated check box.
 - RUN/STOP - Running/Stopped status change.
 - DEPTH/% - Depth/Percent change.
 - DAILY OPS ON/OFF -Daily OPS Enable is turned on/off.
 - PROGRAM STEP - A step in a user program finishes executing.
 - SIS ON/OFF - Stop-In-Slot is turned on/off.
 - DEGREE CHANGE (10) - Position changes by more than a user-defined degree interval from 1° - 359°. The default value is 10°. (The user is prompted to enter the number of degrees when the option is toggled to the enabled state).
 - ABS DEGREE (0.0) - Absolute position that is a user-defined degree from 0.0° - 359.9°. The default value is 180.0°. (The user is prompted to enter the position, in degrees, when the option is toggled to the enabled state).
 - FOR/REV - Direction changes (forward/reverse).
 - END GUN - When the end gun is enabled, and on/off status changes (does not include wide boundary).

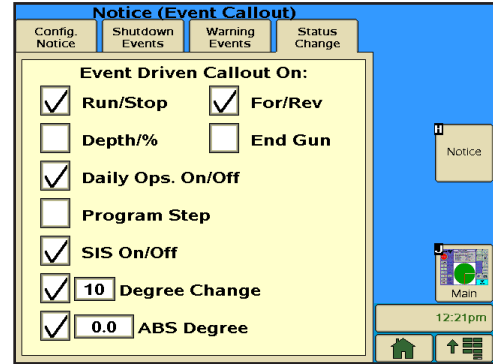

Figure 86-1 Status Change Events Screen

Remote Lockout

Remote Lockout is used to block communications between a BaseStation, or another remote control device, and the TouchPro control panel. When remote lockout is ON, the TouchPro control panel cannot be controlled remotely.

To turn the remote lockout ON or OFF:

1. Push **Options, Remote Lockout** to display the Remote Lockout screen. Refer to Figure 87-1.
2. Check the **Remote Lockout** checkbox to enable remote lockout, and uncheck the checkbox to disable it.

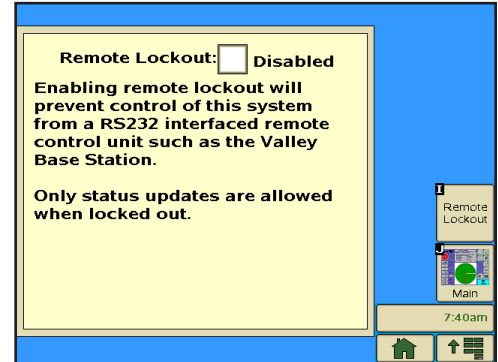
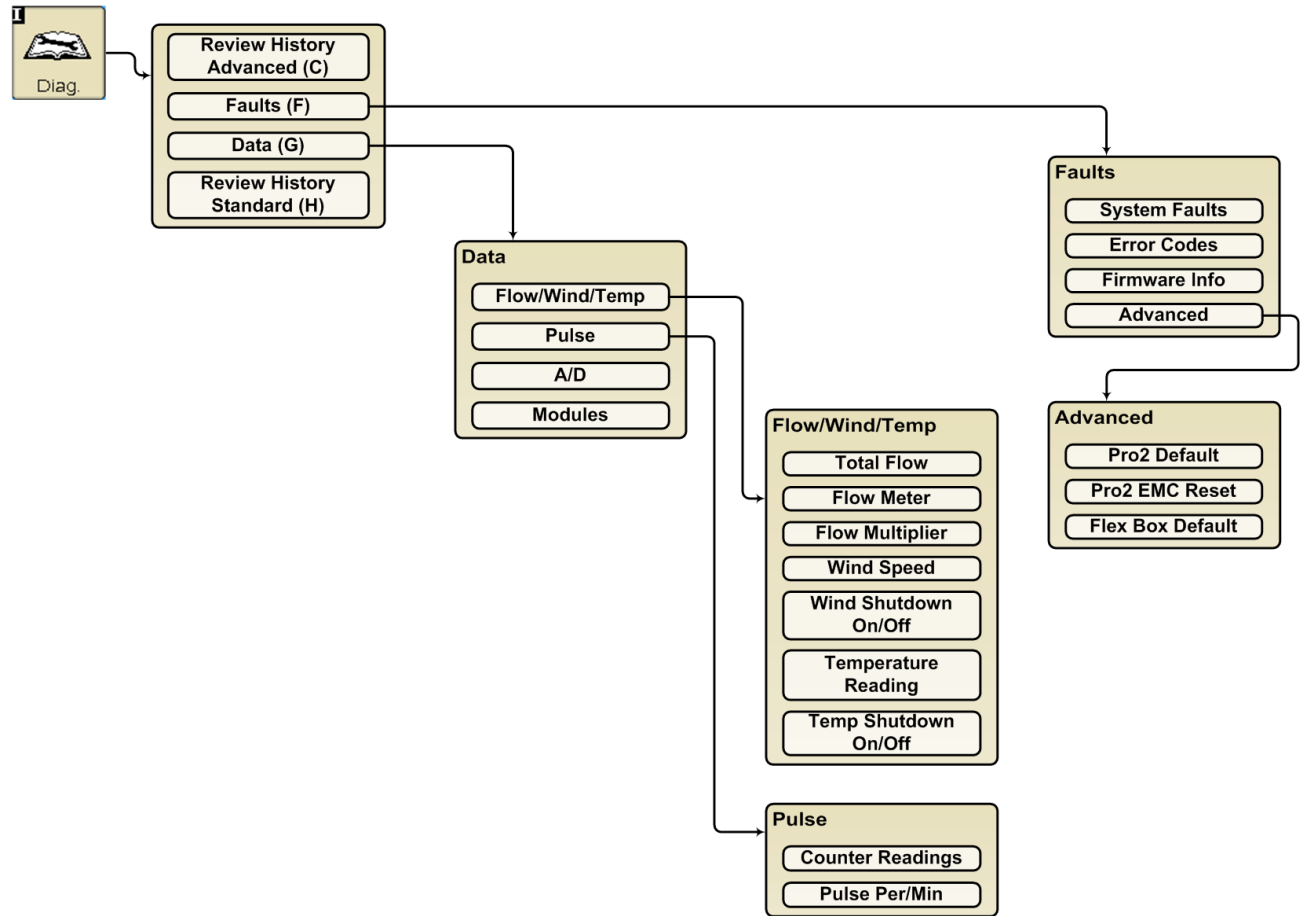

Figure 87-1 Remote Lockout Screen

Options

Diagnostics Screen

The Diagnostics section provides information about using the diagnostic features incorporated into the control panel. Diagnostics aid in identifying machine failures, troubleshooting, and correcting problems. The following functions can be accessed from the Diagnostics screen.



Push the **Diag** button to view the Diagnostics screen. Refer to Figure 89-1.

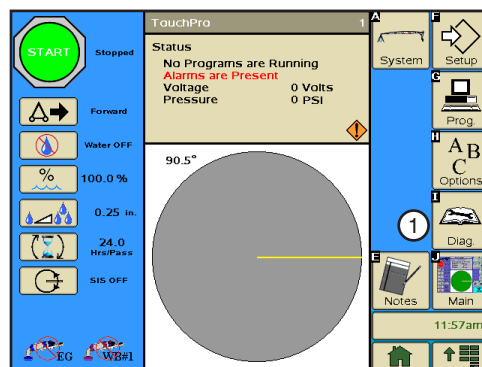

Figure 89-1 1. Diagnostics Button

Diagnostics

Faults

System Faults

System faults are failures that shut the machine down. Any item showing **Fault** on the System Faults screen has caused the machine to shut down. Refer to the TouchPro Control Panel Owners Manual (part number 0999006 English) for a list of system faults and descriptions. Refer to Figure 90-1.

Error Codes

If a failure occurs, an error code appears on the main screen. If more than one error has occurred, the errors that have occurred sequence between each other every second.

For each error code there is an error log. When an error occurs, information about the error, including the first time and date that the error occurred, last time and date that the error occurred, and total count of all times that the error occurred, is recorded in the error log and displayed on the Error Code screen. Refer to the TouchPro Control Panel Owners Manual (part number 0999006 English) for a list of error codes. Refer to Figure 90-2.

Firmware Info

The Firmware Info screen displays the version associated with the TouchPro module and the Flex Box. Refer to Figure 90-3.

Advanced

The Advanced screen contains all default and reset functions for the TouchPro module and Flex Box. Refer to the TouchPro Control Panel Owners Manual (part number 0999006 English) for detailed information. Refer to Figure 90-4.

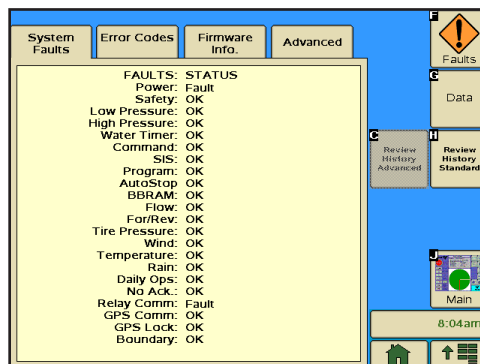

Figure 90-1 1. System Faults Tab

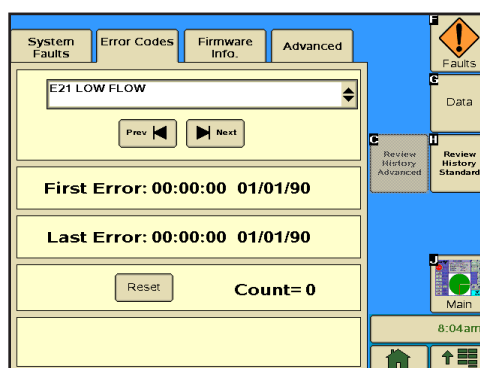

Figure 90-2 1. Error Codes Tab

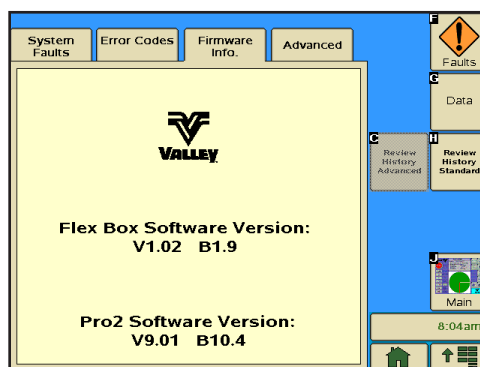

Figure 90-3 1. Firmware Info Tab

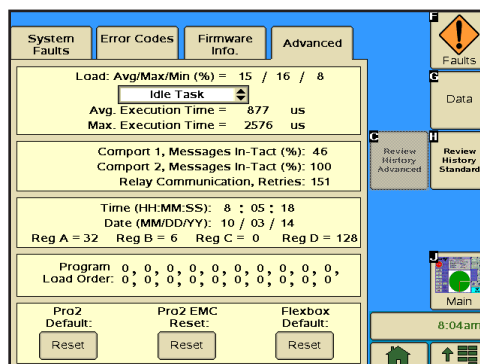

Figure 90-4 1. Advanced Tab

Data

Data is used to review machine information collected by the control panel. There are four data types available. Refer to the Data section of the Options chapter in this manual for detailed information.

- FLOW/WIND/TEMP - Review the total flow volume and rate of flow when the flow meter option is installed. Review wind speed when the wind meter option is installed. Review the temperature when the temperature sensor option is installed. Refer to Figure 91-1.
- PULSE - Review electrical pulse counters and rates. Refer to Figure 91-2.
- A/D - Review analog to digital voltages for troubleshooting. Refer to Figure 91-3.
- MODULES - Review the status of selected relays. A relay is considered a module. Refer to Figure 91-4.

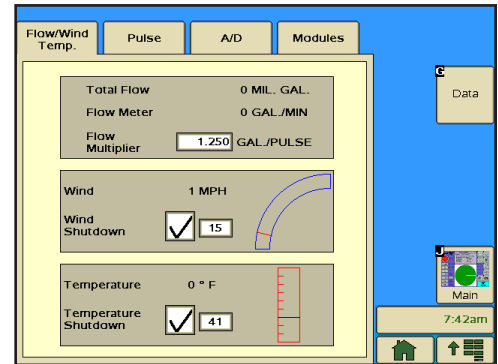

Figure 91-1 1. Flow/Wind Temp. Tab

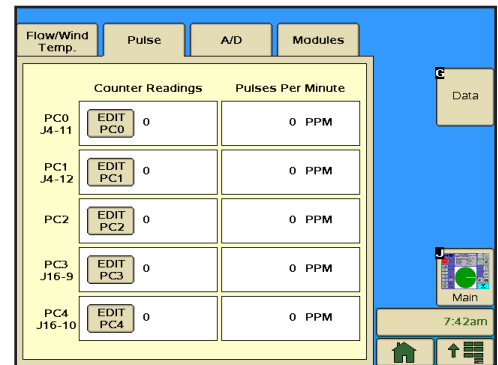

Figure 91-2 1. Pulse Tab

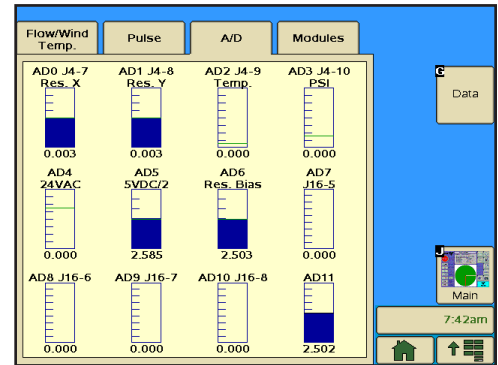

Figure 91-3 1. A/D Tab

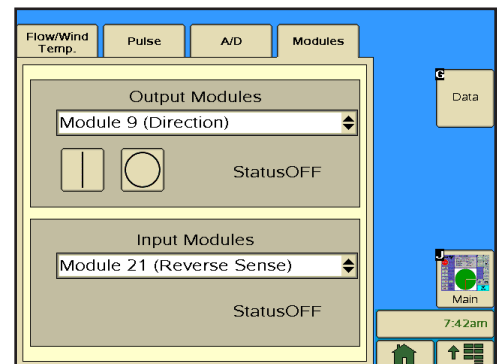

Figure 91-4 1. Modules Tab

Diagnostics

Review History Standard

Review History provides a record of the 99 most recent machine operation status changes via the History Review screen. The History Review screen number is in the upper left hand corner. REVIEW 01 is the newest status change and REVIEW 99 is the oldest status change. Refer to Figure 92-1.

Refer to the TouchPro Control Panel Owners Manual (part number 0999006 English) for detailed information.

Review History Advanced

The Review History Advanced screen displays a record of all error codes and all auxiliary relay conditions related to the status review screen being displayed. Information about various conditions and states is also provided. Refer to Figure 92-2.

Refer to the TouchPro Control Panel Owners Manual (part number 0999006 English) for detailed information.

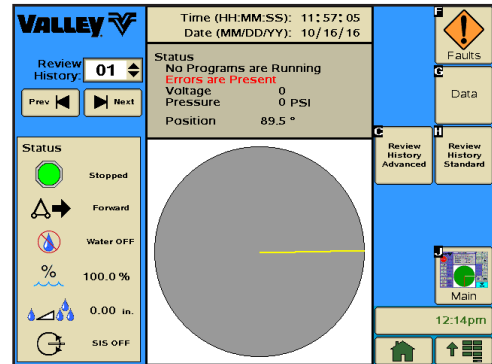

Figure 92-1 1. Review History Standard Screen

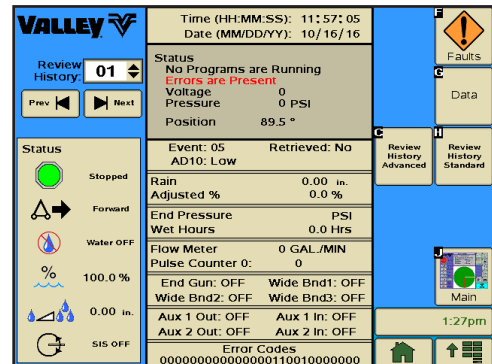

Figure 92-2

Program Screen

From the Sector Program screen the user can choose to create, edit, store, run, review, and erase Sector programs. Refer to Figure 93-1.

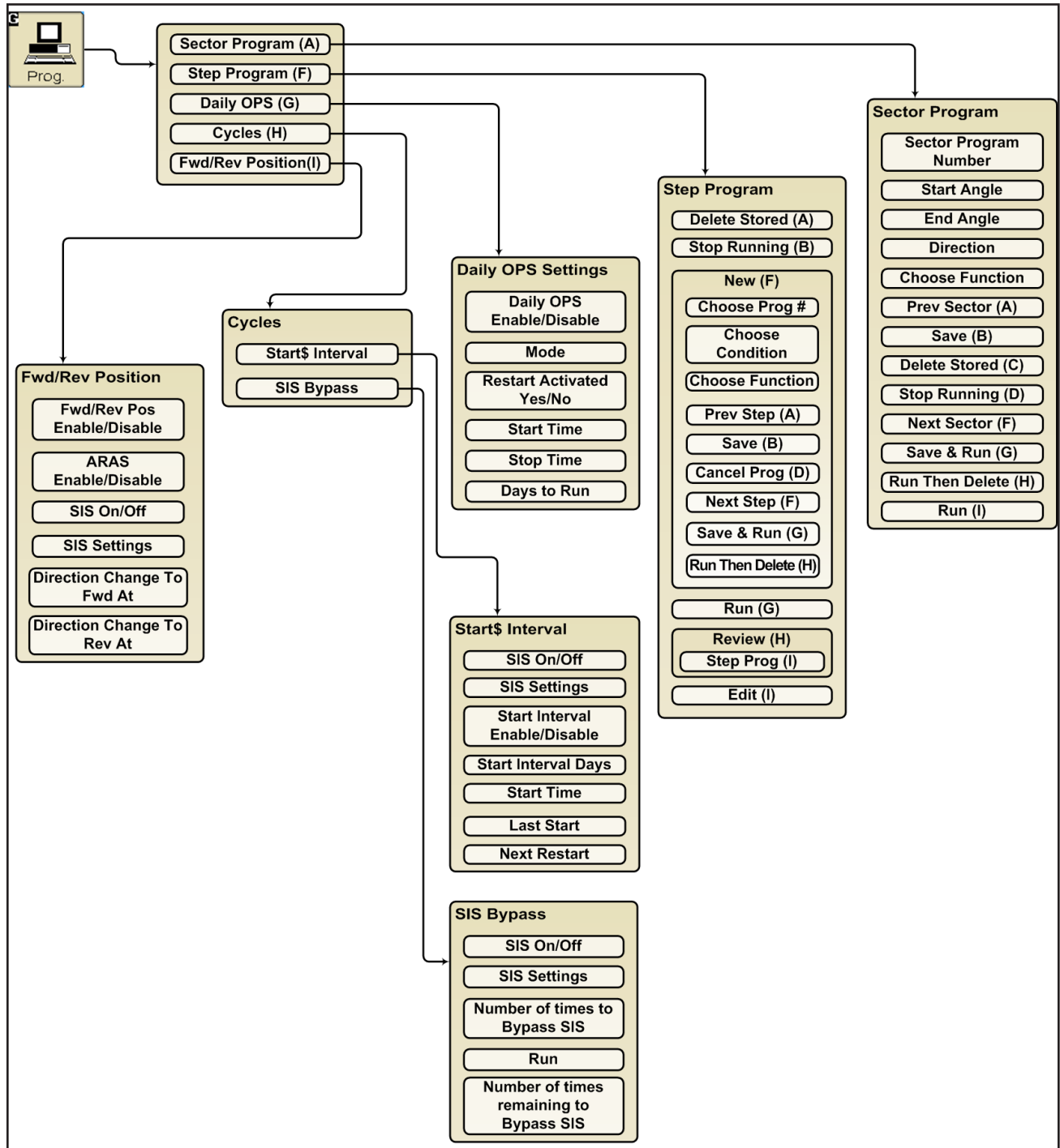

Figure 93-1 Sector Programming

Sector Programs

Sector Programming

Sector programming allows you to specify commands to be executed in unique regions, or sectors, of the field. When the machine enters the region, the Sector program overrides the normal machine operation with temporary settings. When the machine leaves the region, all settings are returned to the original settings.

Up to 20 Sector programs can be written for one field, with a maximum of 9 commands in each. The commands in a program are executed in the order in which they appear in the program.

When the program is completed, it is deleted from the current memory, but remains in the stored memory.

Sector Program Functions

- Sector Program screen - Use to write new sector programs, review and edit stored sector programs which can be recalled for execution.
- Save - Use to save a sector program in stored memory.
- Run - Use to load stored sector programs in current memory for execution.
- Delete Stored - Use to erase stored sector programs from memory.

Available Commands

- Stop
- Water ON/OFF
- Depth
- Percentage
- Auxiliary 1 ON/OFF
- Auxiliary 2 ON/OFF
- Module - OFF
- Module - ON
- % of %, Adjust % Timer
- % of Depth, Adjust Depth by a %
- Cruise Control Enable/Disable
- VRI ON/OFF
- Endgun Enable/Disable
- Wide Boundary 1 Enable/Disable

Using Run

A stored Sector program can easily be run from the TouchPro control panel.

1. Push **Prog**, **Sector Prog.** to view the Program screen. Refer to Figure 95-1.
2. Select the **Program Number** field and choose the number of the program you want to run.
3. Push **Run** to run the selected program.

The program commands will be executed when the machine reaches the region specified. Indication that the program is running occurs in multiple places.

On the Sector Program screen:

- The sector program number appears at the top of the screen after the Running heading. Refer to Figure 95-2.

On the Main screen.

- Programs are Running flashes in the status area. Refer to Figure 95-3.

Two Sector programs with overlapping regions, running in the same direction, cannot be run at the same time. If you attempt to run a stored program that overlaps with a running program, and runs in the **same** direction, the system displays a message telling you it cannot be loaded. Refer to Figure 95-4. You can then modify the start or end angles of one or the other programs to allow them both to be run.

NOTE: Two Sector programs with overlapping regions, running in **opposite** directions, can be run at the same time.

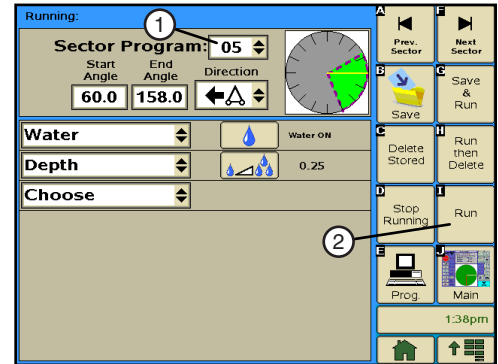

Figure 95-1 1. Program Number Field
2. Run Button

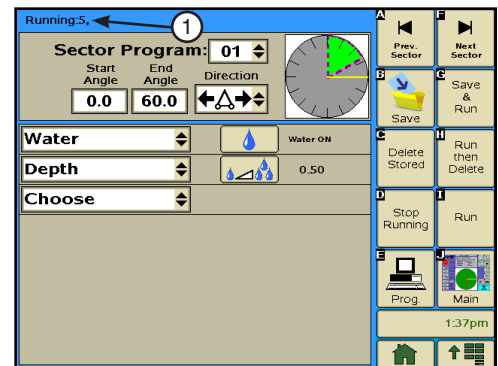

Figure 95-2 1. Program Running Indicator

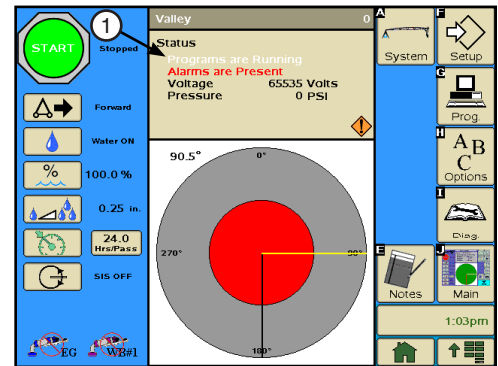

Figure 95-3 1. Program Running Indicator

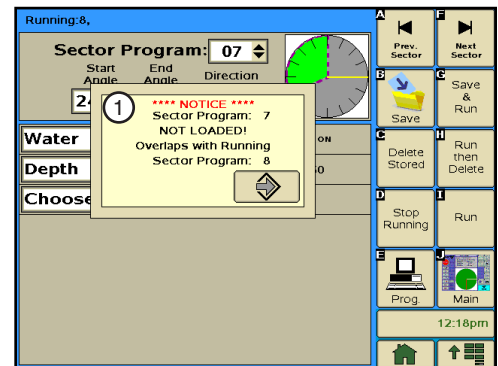

Figure 95-4 1. System Notification

Sector Programs

Sample Sector Program Design Form

The Sector Program Design Form is a useful tool when you are planning your Sector program. It provides you with the ability to describe the left and end angles, direction, and actions you want included in the program. Figure 96-1 below is an example of how the sectors could each be mapped out and described.

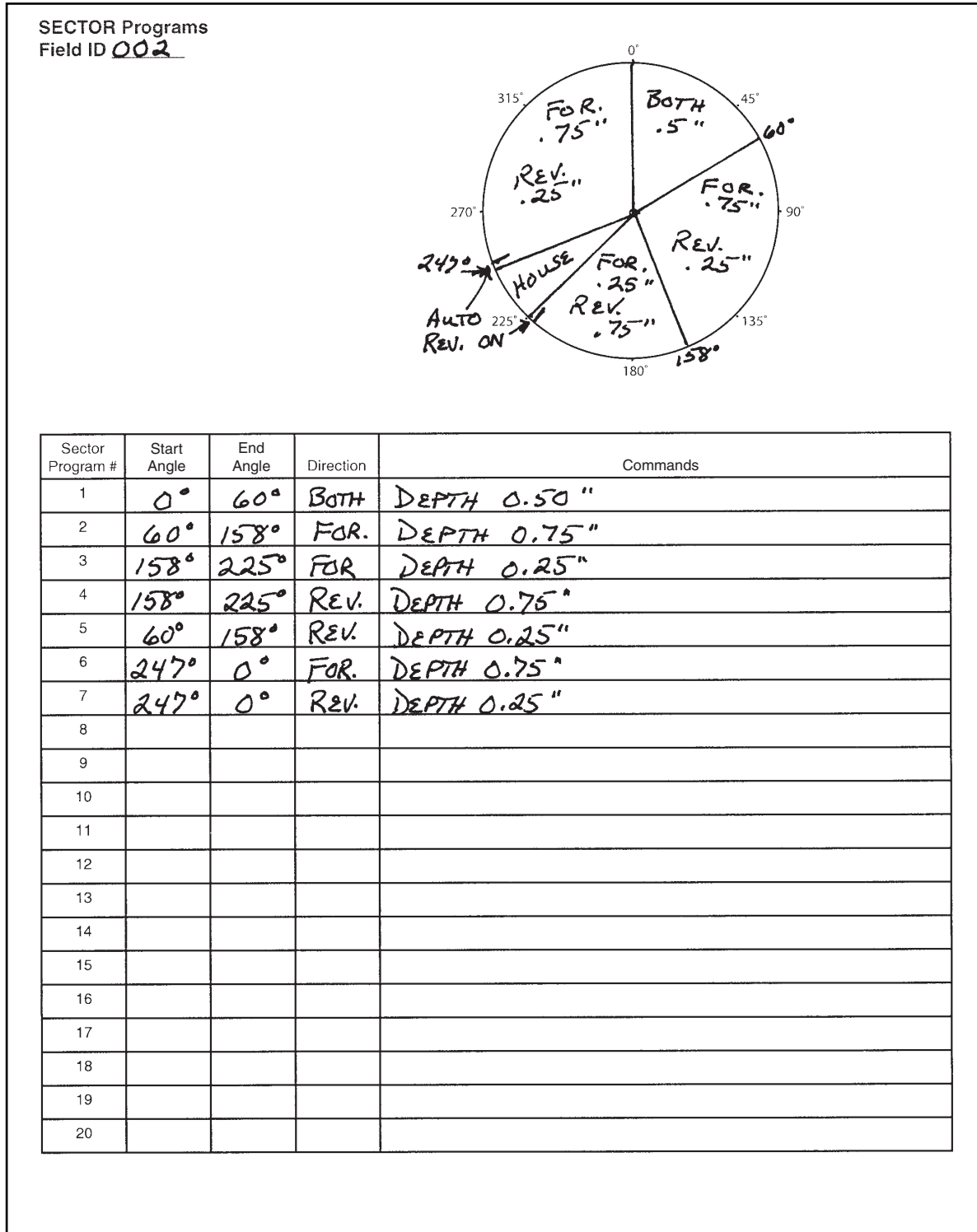

Figure 96-1

Write a New Program

To write a new Sector program, fill in a copy of the Sector Program Design Form with commands for each step. Refer to the sample Sector Program Design Form on the previous page. Blank forms are located in the Appendix. Using a completed design form, follow the steps below:

1. Push **Prog, Sector Prog.** to view the Sector Program screen. Refer to Figure 97-1.
2. Select the **Sector Program** field and choose the number of the program you want to create.
3. Select the **Start Angle** field.
4. Using the numeric keypad, enter the start angle of the new sector.
5. Push **Enter** to retain this value.
6. Select the **End Angle** field.
7. Using the numeric keypad, enter the end angle of the new sector.
8. Push **Enter** to retain this value.
9. Select the **Direction** field.
10. Choose the direction in which the machine will be moving when this sector program begins. The choices are:
 - BOTH - The program will begin when the machine is moving either forward or in reverse.
 - FORWARD - The program will begin only when the machine is moving forward.
 - REVERSE - The program will begin only when the machine is moving in reverse.
11. To choose the commands for this sector do the following.
 - a) Select the **Command** drop-down menu and choose a command.
 - b) Set the command as required to turn On/Off, Enable/Disable or enter a parameter.
12. Repeat steps 2 through 12 for all sectors of the field.
13. Finish the program by selecting one of the following.
 - Push **Save** to save the program.
 - Push **Save & Run** to Save and then Run the program.
 - Push **Delete Stored** to cancel the program.
 - Push **Run Then Delete** to run the program once and then delete it.

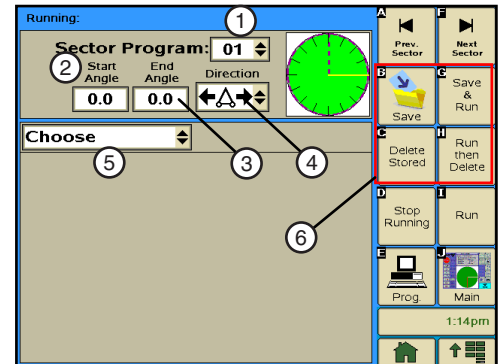

Figure 97-1 1. Sector Program Field
 2. Start Angle Field
 3. End Angle Field
 4. Direction Field
 5. Command Drop-Down Menu
 6. Storage Commands

Sector Programs

Reviewing or Editing Sector Programs

To review current Sector program(s) that are running, or will be executed as soon as their boundaries are reached, follow the steps below.

1. Push **Prog.** and **Sector Prog.** to view the Sector Program screen. Refer to Figure 98-1.
2. Select the **Sector Program** drop-down menu and choose the number of the program you want to review or edit.
3. You can now review or edit the program.
 - If no changes are required, push **Prog** to accept the program and exit.
 - If changes are required, make changes to any command or condition.
4. When done, push **Save** to save the program.
5. Push **Prog.** to exit.

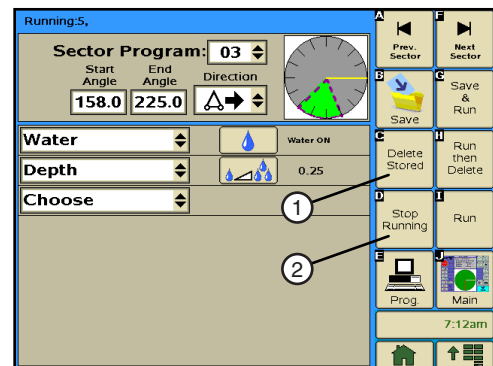

Figure 98-1 1. Delete Stored Button
2. Stop Running Button

Using Delete Stored

To delete a Sector program that is stored in memory, follow the steps below.

1. Push **Prog** and **Sector Prog.** to view the Sector Program screen. Refer to Figure 98-1.
2. Select the **Sector Program** drop-down menu and choose the number of the program you want to delete.
3. Push **Delete Stored** to delete the stored program number.

Using Stop Running

To stop a program that is running, follow the steps below.

1. Push **Prog** and **Sector Prog.** to view the Sector Program screen. Refer to Figure 98-1.
2. Select the **Sector Program** drop-down menu.
3. Choose the number of the program you want to stop.
4. Push **Stop Running** to stop the program.

Designing Sector Programs

A sector program is a list of commands which need to occur in a specified order. The completed Sector Program Design Form example below illustrates how to use the form to outline the following example program. Refer to Figure 99-1.

Sample Sector Program Design Form

Current Conditions:

- Machine ON at 0°.

Program Machine By:

- Position: At 45°, Water On, End-Gun Disabled, Depth 0.75 Inches
- Position: At 135°, Return to original settings
- Position: At 180°, Water Off, Percent 100
- Position: At 225°, Return to original settings

The program design form has been filled out to reflect the example program. Follow these steps as a guide when thinking about programs you want to write.

1. Make a sketch of the field and identify what you want the irrigation machine to do.
2. Determine what must happen first. This will be Sector Program #1.
3. Identify the start and end angles of the sector. (Ex: 45° and 135°)
4. Identify the direction in which the machine will be moving when the program is run (Forward, Reverse, or Both). (Ex: Both)
5. Identify what commands need to occur for Sector Program #1. (Ex: WATER ON, END-GUN DISABLED, 1.00 inch DEPTH)
6. Determine conditions and commands for other sectors.

NOTE: The commands in a sector program are executed when the machine is running in the specified sector and direction.

If you complete the Sector Program Design Form, it makes entering the program easy.

Just follow each row across and enter the correct information.

A blank Sector Program Design Form is provided in the Appendix.

SECTOR Programs
Field ID 002

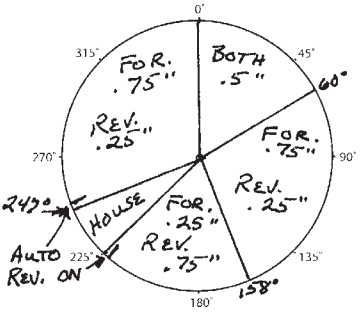

Sector Program #	Start Angle	End Angle	Direction	Commands
1	0°	60°	BOTH	DEPTH 0.50"
2	60°	158°	FOR.	DEPTH 0.75"
3	158°	225°	FOR.	DEPTH 0.25"
4	158°	225°	REV.	DEPTH 0.75"
5	60°	158°	REV.	DEPTH 0.25"
6	247°	0°	FOR.	DEPTH 0.75"
7	247°	0°	REV.	DEPTH 0.25"
8				
9				
10				
11				
12				
13				
14				
15				
16				
17				
18				
19				
20				

Figure 99-1

Sector Program Examples

Using the STOP Command

In this program example, the machine is being programmed to stop in the event that it is not stopped by a barrier before crashing into a ditch. The grower will have to manually restart the machine to change its direction. There will be two sectors in this program to accommodate both forward and reverse directions. Refer to Figure 100-1.

Normal System Operation:

- Machine: On at 0°
- Water: On
- Direction: Both
- Depth: 0.75 Inches

Program Sector:

- Start angle: 189°
- End angle: 225°
- Direction: Both
- Command(s): Stop

Start Programming

To program this example, follow these steps.

1. Push **Prog.** and **Sector Prog.** to view the Sector Program screen. Refer to Figure 100-1.
2. Select the **Sector Program** drop-down menu and choose sector number 1.

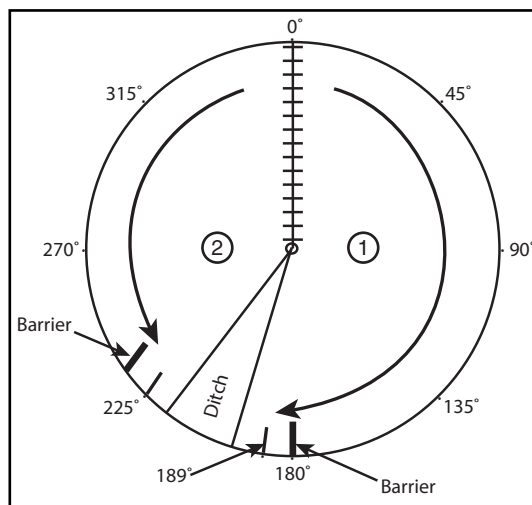

Figure 100-1 1. Sector 1 -Forward
2. Sector 2 - Reverse

Program the Sector

3. Program the start and end angles, and direction for this sector. Refer to Figure 100-1.
 - a) Select the **Start Angle** field and enter **2, 2, 2** for a start angle of 222 degrees.
 - b) Push the **Enter** button.
 - c) Select the **End Angle** field and enter **1, 8, 9** for an end angle of 189 degrees.
 - d) Push the **Enter** button.
 - e) Select the **Direction** field and choose **BOTH** directions.
4. Enter the command for this sector. Refer to Figure 100-2.
 - a) Select the **Command** field.
 - b) Choose **STOP**.

All of the steps have been created for this program. Continue with **Finish Programming**.

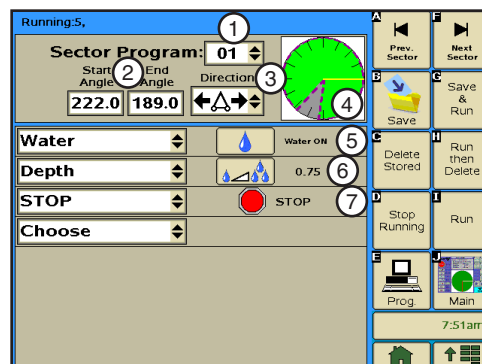

Figure 100-2 1. Sector Program Number
2. Start and Stop Angles
3. Direction Drop-Down Menu
4. Graphical Field Representation
5. Water ON Command
6. Depth = 0.75 In. Command
7. STOP Command

Using the STOP Command

Programming the Sector (continued)

Finish Programming

5. Finish the program by selecting one of the following. Refer to Figure 101-1.
 - Push **Save** to save the program.
 - Push **Save & Run** to Save and then Run the program.
 - Push **Delete Stored** to cancel the program.
 - Push **Run Then Delete** to run the program once and then delete it.

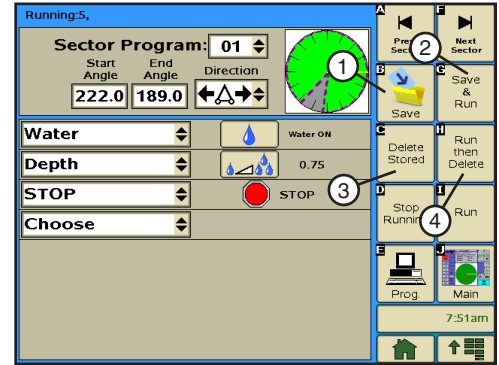

Figure 101-1 1. Save Button
2. Save & Run Button
3. Delete Stored Button
4. Run Then Delete Button

Sector Program Examples

Using the Depth and Percent Commands

In this programming example, the machine is programmed to override the normal system operation at a wet area of the field, resume normal operation, override the normal system operation at a dry area of the field, and resume normal operation. Refer to Figure 102-1

Normal System Operation:

- Machine: On at 0°
- Water: On
- Direction: Forward
- Depth: 0.75 Inches

Program First Sector:

- Start angle: 72°
- End angle: 90°
- Command(s): Water Off, Percent 100

Program Second Sector:

- Start angle: 180°
- End angle: 222°
- Command(s): Depth 1.00 Inch

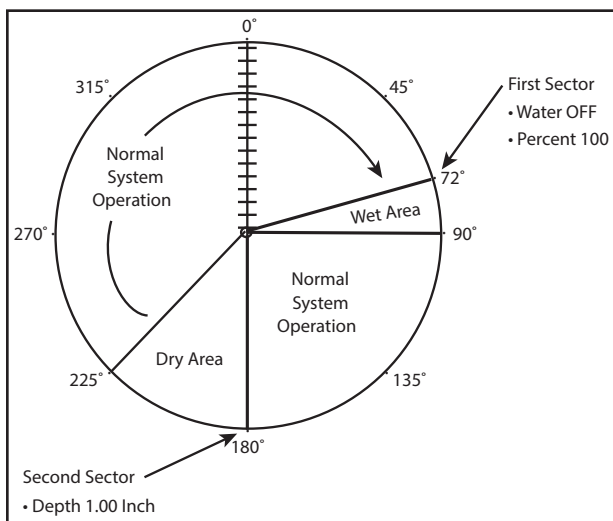

Figure 102-1

Start Programming

To program this example, follow these steps.

1. Push **Prog.** and **Sector Prog.** to view the Sector Program screen. Refer to Figure 102-2.
2. Select the **Sector Program** field and choose sector number 1.

Program the First Sector

3. Program the start and end angles, and direction for this sector. Refer to Figure 102-2.
 - a) Select the **Start Angle** field and enter **7, 2** for a start angle of 72 degrees.
 - b) Push the **Enter** button.
 - c) Select the **End Angle** field and enter **9, 0** for an end angle of 90 degrees.
 - d) Push the **Enter** button.
 - e) Select the **Direction** drop-down menu and choose the **FORWARD** direction.
4. Enter the commands for this sector. Refer to Figure 102-2.
 - a) Select the **Command** drop-down menu and choose **Water OFF**.
 - b) Select the next **Command** drop-down menu and choose **Percentage**.
 - c) Push the **Percentage** Button, enter **1, 0, 0** for 100 percent and push **Enter**.

All of the steps have been created for this program. Continue with **Finish Programming**.

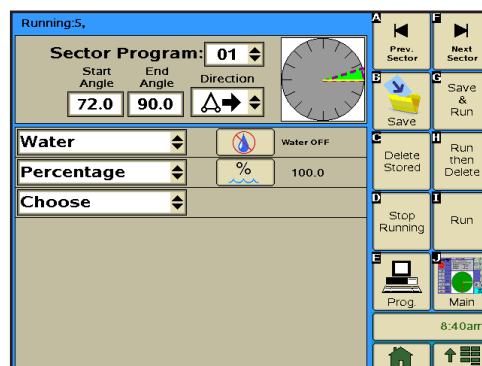

Figure 102-2

Using the Depth and Percent Commands

Program the Second Sector

5. Select the **Sector Program** field.
6. Choose sector number **2**.
7. Program the start and end angles, and direction for this sector. Refer to Figure 103-1.
 - a) Select the **Start Angle** field and enter **1, 8, 0** for a start angle of 180 degrees.
 - b) Push the **Enter** button.
 - c) Select the **End Angle** field and enter **2, 2, 2** for an end angle of 222 degrees.
 - d) Push the **Enter** button.
 - e) Select the **Direction** drop-down menu and choose the **FORWARD** direction.
8. Enter the command for this sector. Refer to Figure 103-2.
 - a) Choose **Depth**.
 - b) Push the **Depth** button, enter **1, ., 0, 0** for 1.00 inches and push **Enter**.

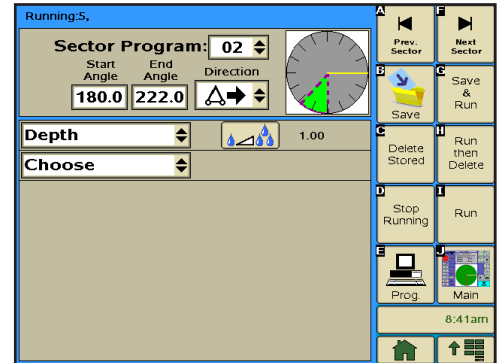

Figure 103-1

All of the steps have been created for this program. Continue with **Finish Programming**.

Finish Programming

9. Finish the program by selecting one of the following.
 - Push **Save** to save the program.
 - Push **Save & Run** to Save and then Run the program.
 - Push **Delete Stored** to cancel the program.
 - Push **Run Then Delete** to run the program once and then delete it.

Sector Program Examples

Using the End Gun and VRI Enable/Disable Commands

In this programming example, the wind in the area has become high, and is expected to stay that way for several days. The grower has decided to turn off the end-gun. Additionally, a portion of the field that is normally wet, has dried out, and the grower wants to apply water in that area. Refer to Figure 104-1.

Normal System Operation:

- Machine: On at 0°
- Water: On
- Direction: Forward
- Depth: 0.50
- End Gun: On
- VRI Zone: On

Program First Sector:

- Start angle: 0°
- End angle: 359.9°
- Command(s): End Gun Disabled

Program Second Sector:

- Start angle: 260°
- End angle: 270°
- Command(s): VRI Zone Off, Depth 1.00

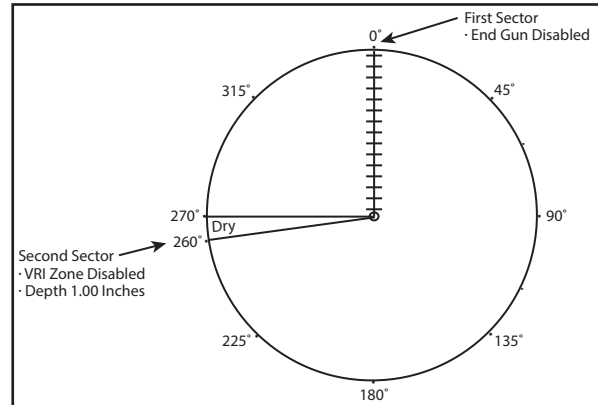

Figure 104-1

Start Programming

To program this example, follow these steps.

1. Push **Prog.** and **Sector Prog.** to view the Sector Program screen. Refer to Figure 104-2.
2. Select the **Sector Number** field and choose sector number 1.

Program the First Sector

3. Program the start and end angles, and direction for this sector. Refer to Figure 104-2.
 - a) Select the **Start Angle** field and enter **0** for a start angle of 0.0 degrees.
 - b) Push the **Enter** button.
 - c) Select the **End Angle** field and enter **3, 5, 9, ., 9** for an end angle of 359.9 degrees.
 - d) Push the **Enter** button.
 - e) Select the **Direction** drop-down menu and choose the **FORWARD** direction.
4. Enter the commands for this sector. Refer to Figure 104-2.
 - a) Select the **Command** field
 - b) Choose **Endgun** and use the default setting of **Disabled (unchecked)**.

All of the steps have been created for this program. Continue with **Finish Programming**.

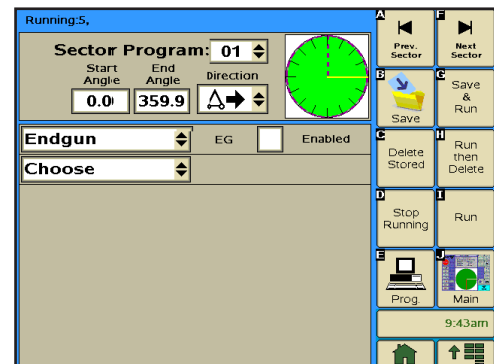

Figure 104-2

Using the End Gun and VRI Enable/Disable Commands

Program the Second Sector

5. Select the **Sector Program** field.
6. Choose sector number **2**.
7. Program the start and end angles, and direction for this sector. Refer to Figure 105-1.
 - a) Select the **Start Angle** field and enter **2, 6, 0** for a start angle of 260 degrees.
 - b) Push the **Enter** button.
 - c) Select the **End Angle** field and enter **2, 7, 0** for an end angle of 270 degrees.
 - d) Push the **Enter** button.
 - e) Select the **Direction** drop-down menu and choose the **FORWARD** direction.
8. Enter the command for this sector. Refer to Figure 105-1.
 - a) Select the **Command** field.
 - b) Choose **VRI ON/OFF** and use the default setting of **Off**.
 - c) Choose **Depth**.
 - d) Push the **Depth** button, enter **1, ., 0, 0** for 1.00 inches and push **Enter**.

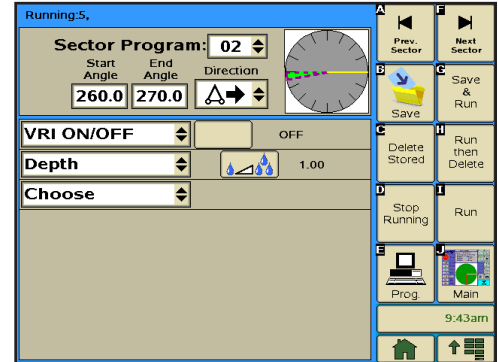

Figure 105-1

All of the steps have been created for this program. Continue with **Finish Programming**.

Finish Programming

9. Finish the program by selecting one of the following.
 - Push **Save** to save the program.
 - Push **Save & Run** to Save and then Run the program.
 - Push **Delete Stored** to cancel the program.
 - Push **Run Then Delete** to run the program once and then delete it.

Sector Program Examples

Using the Percent-of-Percent or Percent-of-Depth Command

In this program example, the region has recently experienced a lot of rain, and a low area of the soybean field has become wetter than usual. The machine is currently running at 60%, but you want to cut that in half for this area of the field. Refer to Figure 106-1.

Normal System Operation:

- Machine: On at 0°
- Water: On
- Direction: Both
- Percent: 60

Program a Sector:

- Start angle: 45°
- End angle: 80°
- Direction: Both
- Command: Percent of Depth = 50

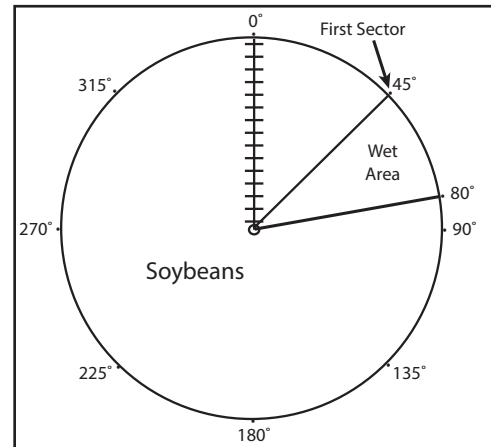

Figure 106-1

Start Programming

To program this example, follow these steps.

1. Push **Prog.** and **Sector Prog.** to view the Sector Program screen. Refer to Figure 106-1.
2. Select the **Sector Number** field and choose sector number 1.

Program the Sector

3. Program the start and end angles, and direction for this sector. Refer to Figure 106-1.
 - a) Select the **Start Angle** field and enter **4, 5** for a start angle of 45 degrees.
 - b) Push the **Enter** button.
 - c) Select the **End Angle** field and enter **8, 0** for an end angle of 80 degrees.
 - d) Push the **Enter** button.
 - e) Select the **Direction** field and choose **BOTH** directions.
4. Enter the commands for this sector. Refer to Figure 106-2.
 - a) Select the **Command** field and choose **% of Depth**.
 - b) Push the **% of Depth** Button, enter **5, 0** for 50 percent of depth and push **Enter**.

All of the steps have been created for this program. Continue with **Finish Programming**.

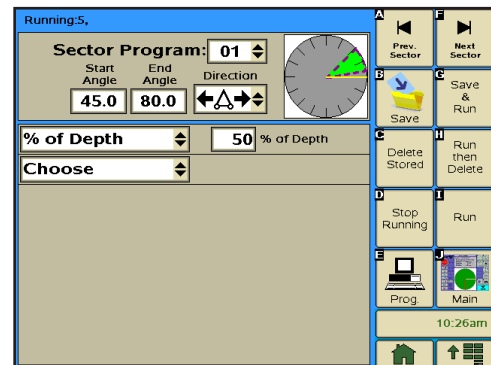

Figure 106-2

Using the Percent-of-Percent or Percent-of-Depth Command

Finish Programming

5. Finish the program by selecting one of the following.
 - Push **Save** to save the program.
 - Push **Save & Run** to Save and then Run the program.
 - Push **Delete Stored** to cancel the program.
 - Push **Run Then Delete** to run the program once and then delete it.

Sector Program Examples

Program Screen

From the Step Program screen the user can choose to create, edit, store, run, review, and erase Step programs. Refer to Figure 109-1.

Push **Prog** and **Step Program** to view the Program screen. Refer to Figure 109-1.

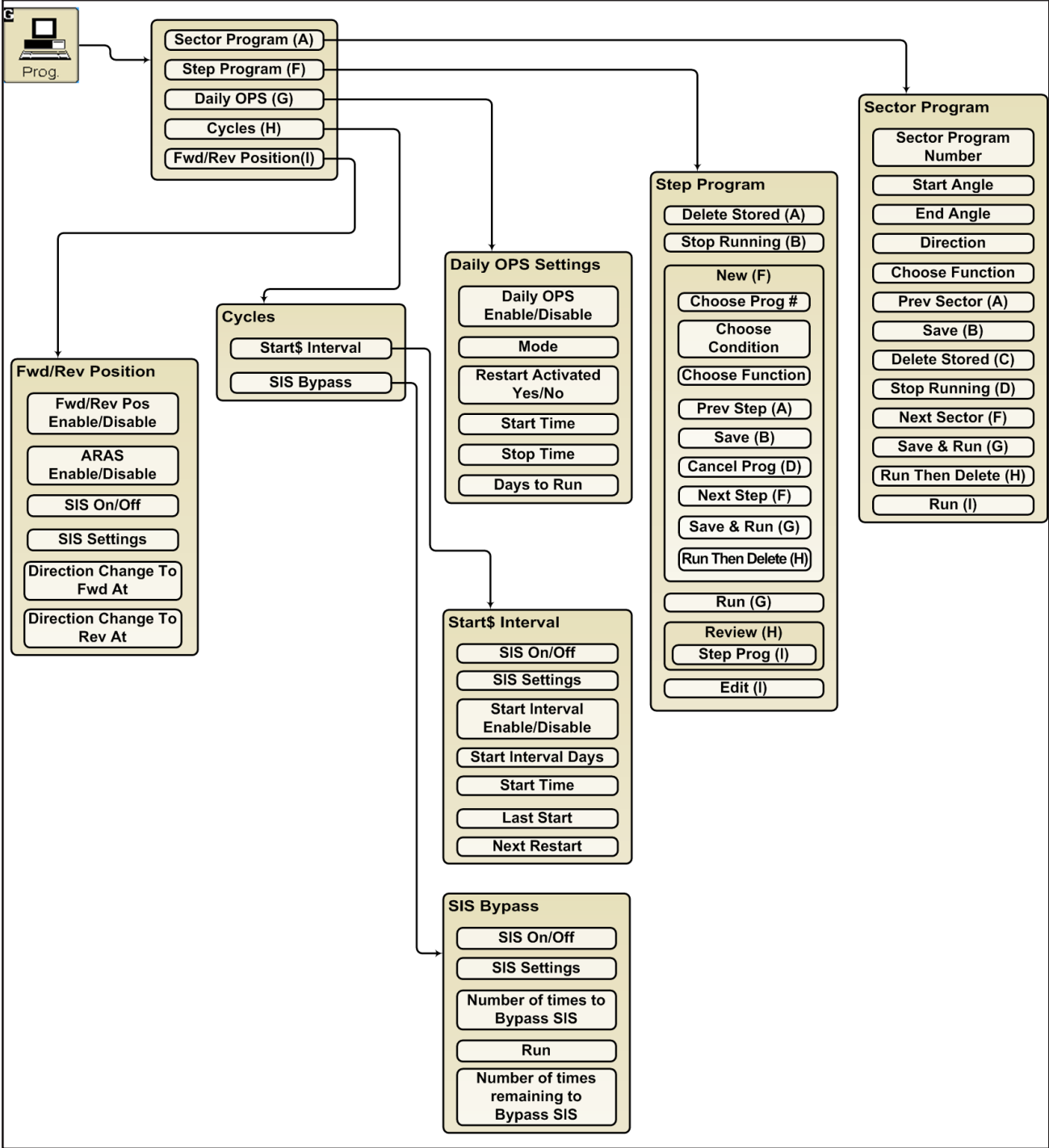

Figure 109-1

Step Programs

Step Programs

Use Step programs to execute one or more commands, options, or a stored Step program based on a selected programming condition. The user can program up to 17 step programs, with a maximum of 9 steps in each. The steps in a program are executed in numerical order.

Program numbers 18, 19, and 20 are used for the START\$, STOP\$, and CYCLE\$ programs.

Up to all twenty programs can be run, or can be current at the same time. If more than one program is current, the computer continuously scans all of the current programs and looks for a step with a condition which is met. If the same condition in two or more step programs is met at the same time, the step in the program that was loaded last is executed.

When the last step of a program is complete, the program is deleted from the current memory, but remains in the stored memory.

Step Program Functions

- Run - Use to load stored step programs in current memory for execution.
- New - Use to write new step programs.
- Review - Use to review stored step programs.
- Stop Running - Use to stop a selected program from running.
- Delete Stored - Use to delete stored step programs which can be recalled for execution
- Edit - Use to edit stored step programs.

Programming Conditions

- Date/Time - Execute commands based on the date and time of day.
- Day/Time - Execute commands based on the day of the week and time of day
- Position - Execute commands based on the position of the machine.
- Pressure - Execute commands based on water Pressure.
- Delay - Execute commands based on a time delay of up to 60,000 seconds (16.67 hours) or 60,000 minutes (41.67 days).
- Direction - Execute commands based on the direction of the machine movement.
- Other Conditions - Refer to Other Programming Conditions on the next page for more information.

Available Commands		Stored Program
<ul style="list-style-type: none"> • Start/Stop • Direction Forward/Reverse • Water ON/OFF • Depth • Percentage • Auxiliary 1 ON/OFF • Auxiliary 2 ON/OFF • Run Program • SIS ON/OFF • Module - OFF • Module - ON • ARAS Auto Reverse/Auto Stop • Auto Restart 	<ul style="list-style-type: none"> • Set Cycle\$ • Start\$/Stop\$ • % of %, Adjust % Timer • % of Depth, Adjust Depth by a % • Trigger a Logging Event • Cruise Control • VRI ON/OFF • Endgun Enable/Disable • Wide Boundary 1 Enable/Disable • Wide Boundary 2 Enable/Disable* • Wide Boundary 3 Enable/Disable* 	<ul style="list-style-type: none"> • Any stored Step program can be run from the last step of another step program. Refer to the RUN PROGRAM command in this section of this manual. • Any stored Step program can be started from any step in the program.

* Must be enabled in Setup/Comm Port/PLC

Other Programming Conditions

- Analog
- Pulse Rate
- Wind
- Rain
- Module
- Count
- Temperature

Analog

This programming condition is based on an analog voltage being higher or lower than the set value. This condition can only be used if an external device with an analog voltage output is connected to the TouchPro control panel. Refer to Figure 111-1.

Analog Number	Description
0	Monitors Resolver Signal X
1	Monitors Resolver Signal Y
2	Not Used
3	Monitors Pressure Transducer Voltage

Analog Number	Description
4	Monitors Machine Voltage
5	Monitors Voltage to Pressure Transducer
6	Monitors Resolver Bias Reference Voltage
7 - 11	Not Used

Figure 111-1 Analog Voltage Connections

Module

This programming condition is based on the condition, either ON/Closed or OFF/Open, of a control relay in the TouchPro control panel. Listed below are the available modules/relays. Refer to Figure 111-2.

MODULE NUMBER	RELAY NUMBER	FUNCTION DESCRIPTION	RELAY BOARD TERMINAL
0	K1	Safety Out	J5-1
1	K2	Percent Timer	J5-2
2	K7	End Gun	J13-5
3	K8	Wide Boundary	J13-6
4	K6	Pump Safety	J13-1, 2, 3
5	K9	Alarm	J6-1, 2, 3
6	K12	Auxiliary 1 Output	J7-1, 2
7	K13	Auxiliary 2 Output	J7-3, 4
8	K4	Contactora Enable	J5-5, 6
9	K3	Direction (Forward=ON, Reverse=OFF)	J5-3, 4
10	D03	Control Panel Backlight	J15-5
11	D02	TTL Output 2	J15-4

MODULE NUMBER	RELAY NUMBER	FUNCTION DESCRIPTION	RELAY BOARD TERMINAL
12	D01	TTL Output 1	J15-3
13	R01	Low Side 1	J15-1
14	R02	Low Side 2	J15-2
15		Not Used	
16		Remote Start	J6-5
17		Pressure Switch	J6-4
18	K5	3 Second timer	
19	K15	Auxiliary 2 Input	J7-7, 8
20	K14	Auxiliary 1 Input	J7-5, 6
21	K10	Reverse Sense	J5-4
22	K11	Forward Sense	J5-3
23	K5	Safety Sense	J5-7
24		PC4/Rain Sense	J16-9
25		PC5	J16-10

Figure 111-2 Available Modules/Relays

Step Programs

Pulse

This programming condition is based on pulse rates of a counter being higher or lower than a set value. This condition can only be used if a device with a pulse output is connected to the TouchPro control panel.

Count

This programming condition is based on pulse counts being higher than a set value. This condition can only be used if a device with a pulse output is connected to the TouchPro control panel. Refer to Figure 112-1.

Counter Number	Description	Relay Board Labels	Relay Board Terminal
0	Monitors Flow Meter	Pulse 1	J4-11
1	Monitors Wind Meter	Pulse 2	J4-12
2	Not Currently Used	N/A	N/A
3	Rain Sensor	3 PC4	J16-9
4	Not Currently Used	4 PC5	J16-10

Figure 112-1 Devices with Pulse Outputs

Wind

This programming condition is based on the wind speed being higher or lower than a set value. The minimum is 0 mph, and the maximum is 300 mph (482.8 km). This condition can only be used if a wind speed sensor is installed.

Temperature

This programming condition is based on the temperature being higher or lower than a set level. The minimum value is 14°F (-10°C) to 176°F (80°C). This condition can only be used if a temperature sensor is installed.

Rain

This programming condition is based on the rainfall being higher or lower than a set level. This condition can only be used if a rainfall sensor is installed.

Run Program Command

A stored Step program can be loaded and run from the last step within the same, or another Step program. It is recommended that the Run Program command be the last command in the last step of the program.

This programming feature can be used to run the same program over, or run programs in a sequence. For example, if there are three stored programs that need to be run in sequence, the last step of program 1 would command program 2 to run. The last step in program 2 would command program 3 to run. And then, the last step in program 3 would command program 1 to run, starting the sequence over.

To add the Run Program command to the last step in another program, follow the instructions below.

1. Push **Prog.**, **Step Prog.** to view the Step Program screen.
2. Push the **Edit** button and choose the program number. Refer to Figure 113-1.
3. Push the **Next Step** button until you reach the last step of the program. Refer to Figure 113-2.
4. Select the **Condition** field and choose **Run Program**.
5. Select the Run **Program Number** field and choose the number of the program that you want to run. Refer to Figure 113-3.
6. Finish the program by selecting one of the following.
 - Push **Save** to save the program.
 - Push **Save & Run** to save and then run the program.
 - Push **Run Then Delete** to run the program once and then delete it.
 - Push **Cancel Prog** to cancel the program.

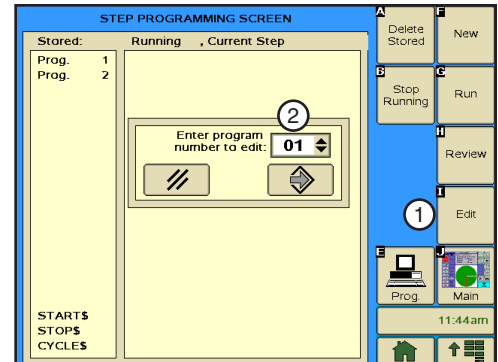

Figure 113-1 1. Edit Button
2. Program to be Edited

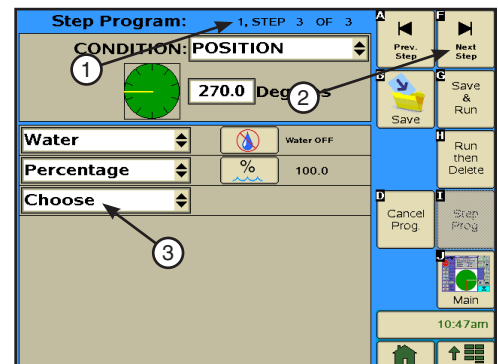

Figure 113-2 1. Program #1, Step 3 of 3
2. Next Step Button
3. Choose Command Field

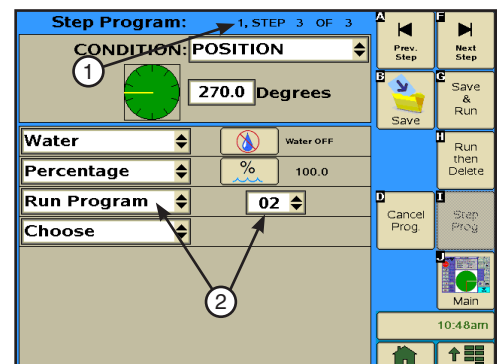

Figure 113-3 1. Program 1, Step 3 of 3
2. Run Program 2 Command Added

Step Programs

Start at a Step

A stored Step program can be started at any given step in the program.

This programming feature can be used to run a program based on a unique situation in the field. For example, a machine is irrigating an area between 0° and 180° in forward and reverse. It happens that the machine is stopped at 180°, and you want it to return in reverse to 0°. You can tell the program to start at step 2 (Reverse) instead of step 1 (Forward).

To start this example of a stored Step program at step 2, you would follow the instructions below.

1. Push **Prog.**, **Step Prog.** to view the Step Program screen.
2. Push the **Run** button, choose the program number, and press **Enter**. Refer to Figure 114-1.
3. Choose the step number of the program where you want it to start. Refer to Figure 114-2.

The program immediately starts running at the step you have specified. Refer to Figure 114-3.

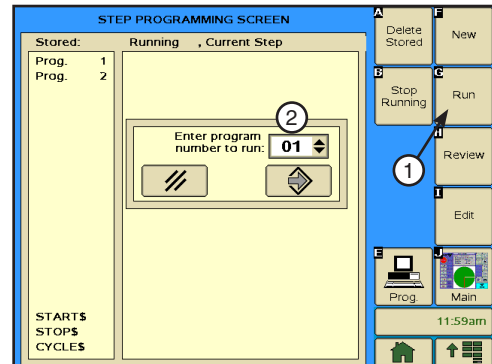

Figure 114-1 1. Run Button
2. Program Number to Run

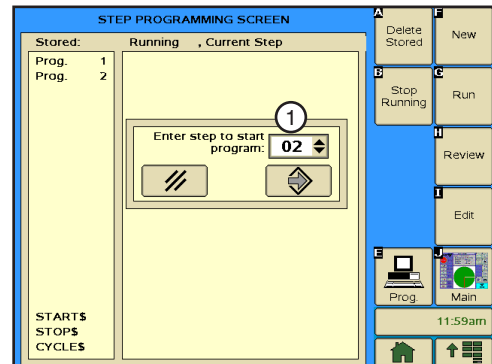

Figure 114-2 1. Step to Start Program

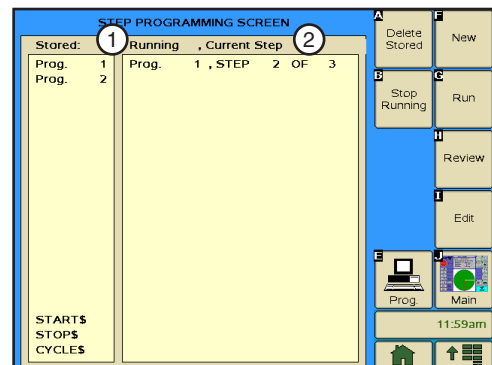

Figure 114-3 1. Current Program Running (1)
2. Current Step of Program (2)

Sample Step Program Design Form

The Step Program Design Form is a useful tool when you are planning your Step program. It provides you with the ability to describe the conditions, commands, and options you want included in the program. Figure 115-1 below is an example of how the steps in Step programming could each be mapped out and described.

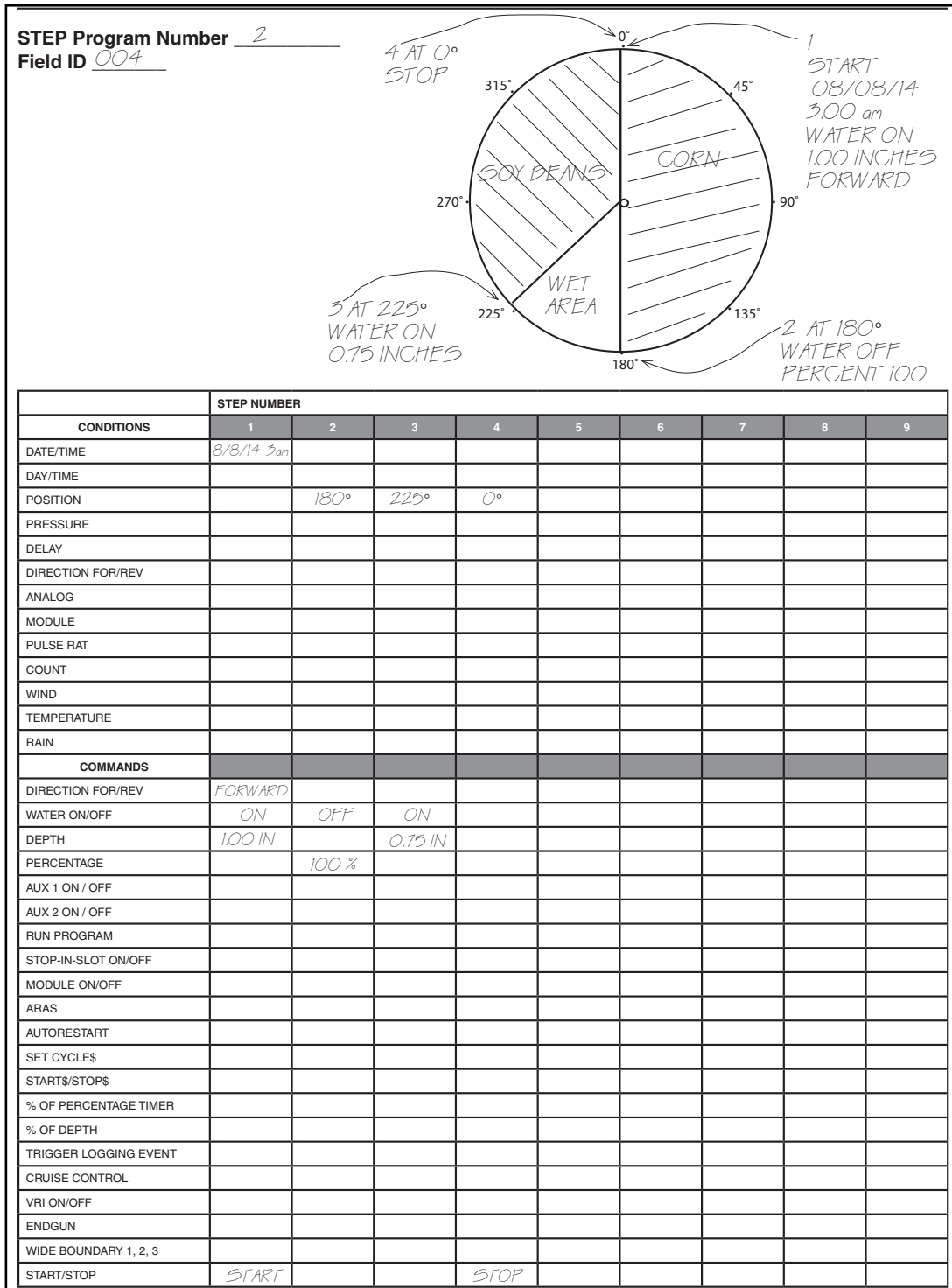

Figure 115-1

Step Programs

Write a New Program

To write a new Step Program, fill in a copy of the Step Program Design Form with conditions and commands for each step. Refer to the sample Step Program Design Form on the previous page. Blank forms are located in the Appendix. Using a completed design form, follow the steps below:

1. Push **Prog.** and **Step Prog.** to view the Step Program screen. Refer to Figure 116-1.
2. Push the **New** button.
3. Select the **New Program Number** field and choose the program number.
4. Push the **Enter** button.
5. Select the **Condition** field and choose a condition for this step. Refer to Figure 116-2.

Set the condition parameters as required for the selected programming condition.

6. Select the **Command** field and choose a command. Refer to Figure 116-3.

Set the command as required to turn On/Off, Enable/Disable or enter a parameter for the selected programming condition.

7. Repeat steps 8 and 9 for additional commands.
8. Finish the program by selecting one of the following.
 - Push **Save** to save the program.
 - Push **Save & Run** to save and then run the program.
 - Push **Run Then Delete** to run the program once and then delete it.
 - Push **Cancel Prog** to cancel the program.

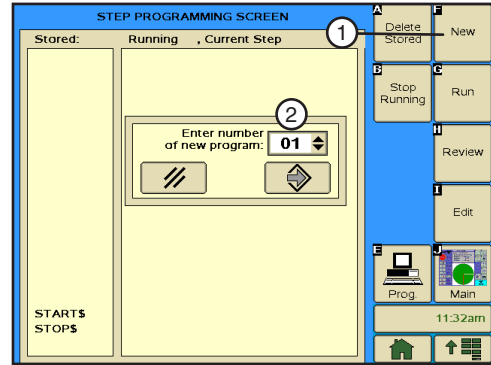

Figure 116-1 1. NEW Button
2. New Program Number

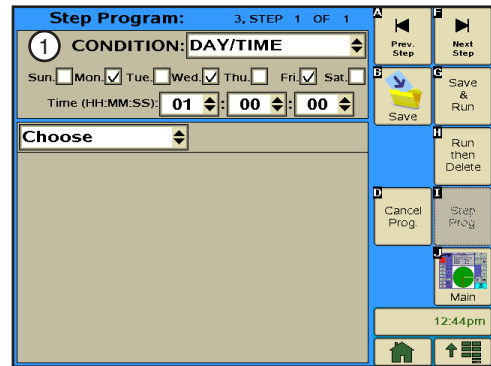

Figure 116-2 1. Condition Field and Parameters

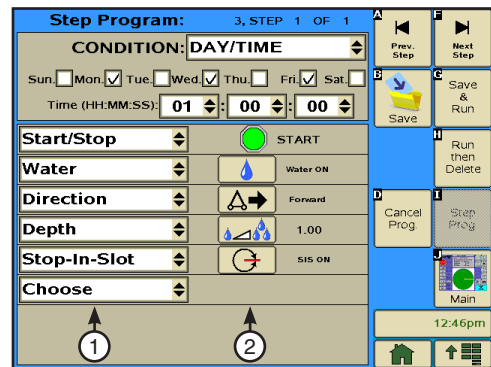

Figure 116-3 1. Command Fields
2. Control Buttons

Using Review

To review Step programs that are stored in memory, running, or will be executed as soon as their conditions are met, follow the steps below. All steps in a program can be reviewed while the program is running. As the running program is being reviewed, an asterisk (*) located in the lower left hand corner indicates the step that contains the next step to be being executed. Step program numbers are not displayed on the review current screen.

1. Push **Prog** and **Step Prog.** to view the Step Program screen. Refer to Figure 117-1.
2. Push the **Review** button.
3. Select the **Program Number** field and choose the number of the program you want to review. Refer to Figure 117-2.

The shaded fields indicate that you are not allowed to access that function or setting.

4. Use the **Next Step** and **Prev. Step** buttons to move through the steps. Refer to Figure 117-3.
5. When you are done reviewing the program, do one of the following.

- Push the **Next Step** button,
 - » If another program is in current memory, the first step of that program is displayed.
 - » If no other programs are in current memory, the last step of the current program continues to be displayed.
- Push the **Step Prog.** button to exit review.

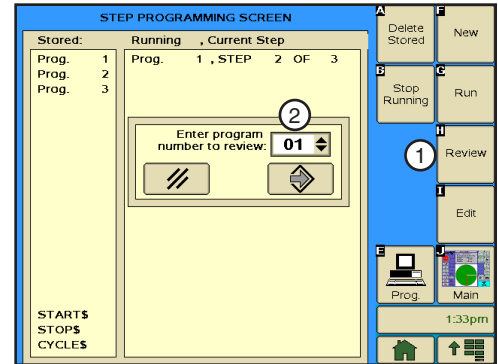

Figure 117-1 1. Review Button
2. Program Number Field

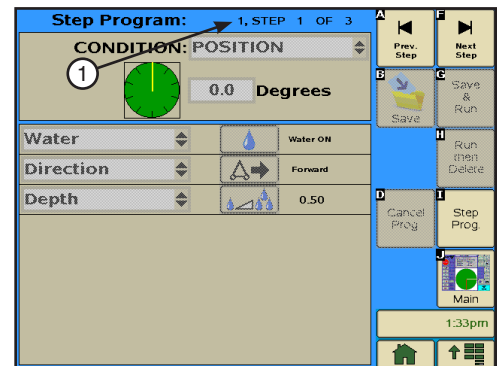

Figure 117-2 1. Step 1 of 3 Indicator

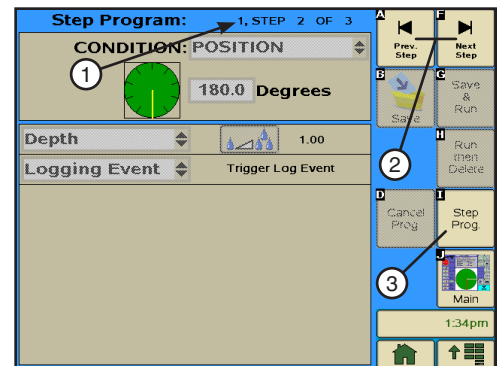

Figure 117-3 1. Step 2 of 3 Indicator
2. Prev. and Next Step Buttons
3. Step Prog. Button

Step Programs

Using Edit

To edit a Step program stored in memory, follow the steps below:

1. Push **Prog.** and **Step Prog.** to view the Step Program screen. Refer to Figure 118-1.
2. Push the **Edit** button.
3. Select the **Program Number** field and choose the number of the program you want to review. Refer to Figure 118-2.
Step 1 of the program is displayed. Refer to Figure 118-3.
4. Select the **Step** field and choose the number of the step you want to edit.
5. Use **Next Step** and **Prev. Step** to move through the steps.
6. Edit the program step, if desired.
 - If no changes are required, Use **Next Step** and **Prev. Step** to move through the steps.
 - To add a new step at the end of the program, push the **New** button.
 - » Program the new step, selecting the programming condition and commands. Up to eight steps can be programmed.
7. When done editing, do one of the following.
 - Push **Save** to save the program.
 - Push **Save & Run** to save and then run the program.
 - Push **Run Then Delete** to run the program once and then delete it.
 - Push **Cancel Prog** to cancel the program.

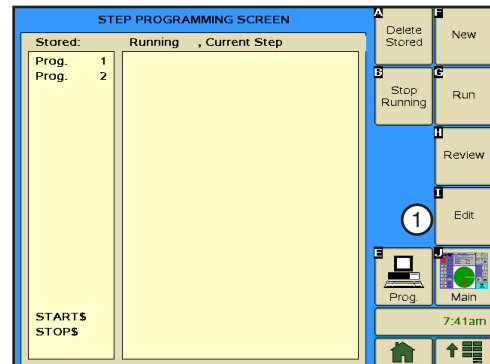

Figure 118-1 1. Edit Button

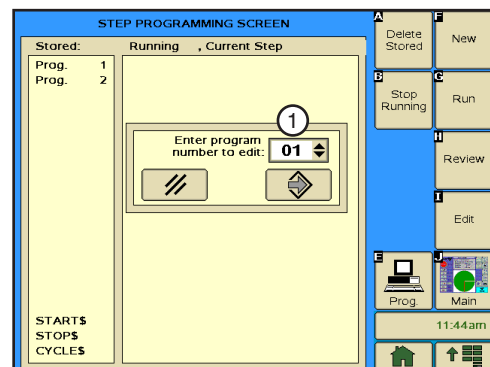

Figure 118-2 1. Program Number Field

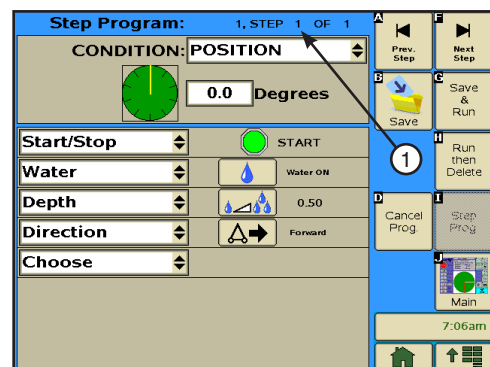

Figure 118-3 1. Step 1

Using Delete Stored

To delete a Step program from stored in memory, follow the steps below:

1. Push **Prog.** and **Step Prog.** to view the Step Program screen. Refer to Figure 119-1.
2. Push the **Delete Stored** button.
3. Select the **Program Number** field and choose the number of the program you want to delete. Refer to Figure 119-2.
4. Push the **Enter** button.

The program is deleted from the stored memory as soon as you press the **Enter** button.

NOTE: To delete a running program from current memory, push the **Cancel Prog.** button.

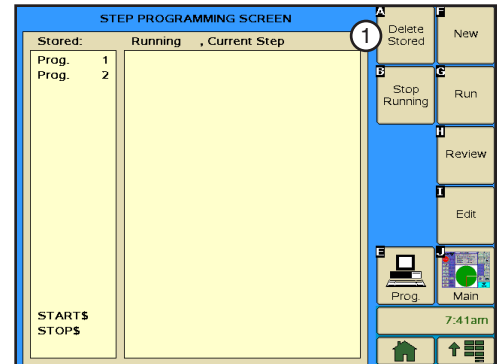

Figure 119-1

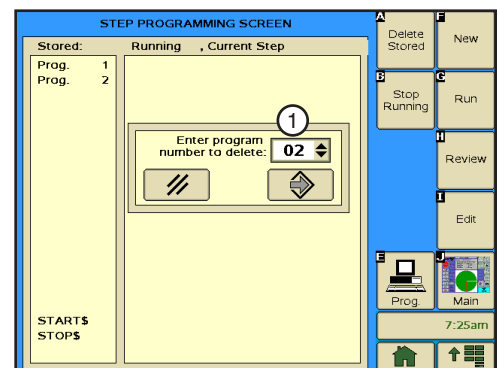

Figure 119-2

Step Programs

Step Program Examples

Designing Step Programs

A program is a list of conditions and commands which need to occur in a specified order. The completed step program design form example below illustrates how to use the form to outline the following example program. Refer to Figure 121-1.

Sample Step Program Design Form

Current Conditions:

- Machine OFF at 0°.

Program Machine By:

- Date/Time: ON 08/08/14, at 3:00 AM, WATER ON, Depth 1.00", FORWARD, START.
- Position: At 180°, WATER OFF, 100 percent.
- Position: At 225°, WATER ON, Depth 0.75".
- Position: At 0°, STOP.

The program design form has been filled out to reflect the example program. Follow these steps as a guide when thinking about programs you want to write.

1. Make a sketch of the field and identify what you want the irrigation machine to do.
2. Determine what must happen first. This is STEP #1. (Ex. START on 08/08/14 at 3:00 AM).
3. Identify the condition. Will STEP #1 occur at a position in the field, a date/time, a specified time delay or other conditions? (Ex. 08/08/14 at 3:00 AM).
4. Identify what commands need to occur for Step #1. (Ex: WATER ON, 1.00 inch DEPTH, FORWARD, START).
5. Determine conditions and commands for other steps.

NOTE: All steps are executed in sequential order.

If you complete the step program design form, it makes entering the program easy.

Just follow each column down and enter the correct information.

STEP Program Number 2
Field ID 004

CONDITIONS	STEP NUMBER								
	1	2	3	4	5	6	7	8	9
DATE/TIME	8/8/14 3am								
DAY/TIME									
POSITION		180°	225°	0°					
PRESSURE									
DELAY									
DIRECTION FOR/REV									
ANALOG									
MODULE									
PULSE RAT									
COUNT									
WIND									
TEMPERATURE									
RAIN									
COMMANDS									
DIRECTION FOR/REV	FORWARD								
WATER ON/OFF	ON	OFF	ON						
DEPTH	1.00 IN		0.75 IN						
PERCENTAGE		100 %							
AUX 1 ON / OFF									
AUX 2 ON / OFF									
RUN PROGRAM									
STOP-IN-SLOT ON/OFF									
MODULE ON/OFF									
ARAS									
AUTORESTART									
SET CYCLES									
STARTS/STOPS									
% OF PERCENTAGE TIMER									
% OF DEPTH									
TRIGGER LOGGING EVENT									
CRUISE CONTROL									
VRI ON/OFF									
ENDGUN									
WIDE BOUNDARY 1, 2, 3									
START/STOP	START			STOP					

Blank step program design form Figure 121-1 is provided in the Appendix.

Step Program Examples

Example 1. Program by Date, Time and Position

In this program example, the machine is being programmed to start on a specific date and time, water one half of the field, turn the water off, and increase speed over set aside acres. It then turns the water on, sets the depth, and waters the remaining half of the field, stopping at 0°. Refer to Figure 122-1.

Current Machine Condition:

- Machine is OFF at 0°.

Program Machine By:

- Time: ON 08/08/14 at 3:00 AM, WATER ON, FORWARD, Depth 1.00", START.
- Position: At 180°, WATER OFF, Percent 100.
- Position: At 225°, WATER ON, Depth 0.75".
- Position: At 0°, STOP.

Start Programming

To program Example 1, follow these steps.

1. Push **Prog.** and **Step Prog.** to view the Step Program screen. Refer to Figure 122-1.
 - a) Push the **New** button.
2. Select the **New Program** field.
3. Choose the Program Number.
 - a) Push the **Enter** button.

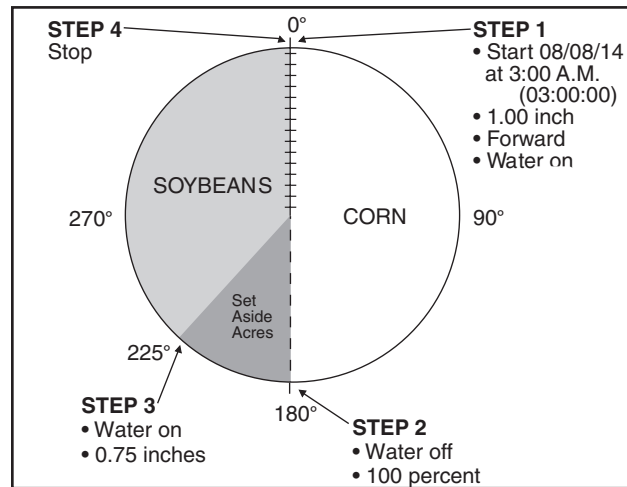

Figure 122-1

Program STEP 1 - Example 1

4. Program the date and time condition for this step, do the following. Refer to Figure 122-2.
 - a) Select the **Condition** field and choose **Date/Time**.
 - b) Select the **MM/DD/YY Date** fields one at a time and choose 08, 08, 16 for August 8, 2016.
 - c) Select the **HH/MM/SS Time** fields one at a time and choose 03, 00, 00 for 3:00 AM.
5. Enter the commands to execute on 08/08/16 at 3:00 AM. Refer to Figure 122-3.
 - a) Select the **Command** field and choose **Water**.
 - b) Push the **Water** button to set the command to Water On.
 - c) Select the next **Command** field and choose **Direction**.
 - d) Push the **Direction** button to set the command to Forward.
 - e) Select the next **Command** field and choose **Depth**.
 - f) Push the **Depth** button, enter 1, ., 0, 0 for 1.00 inches and push the **Enter** button..
 - g) Select the next **Command** field and choose **Start/Stop**.
 - h) Push the **Start/Stop** button to set the command to Start.
 - i) Push **Next Step** to add step 2.

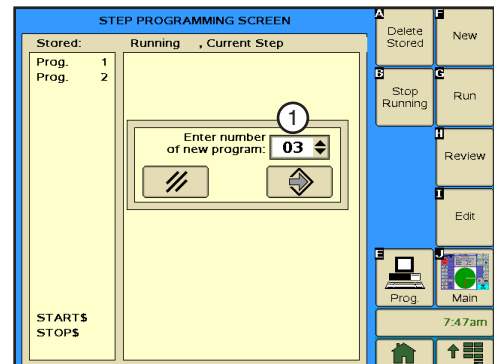

Figure 122-2 1. New Program Number Field

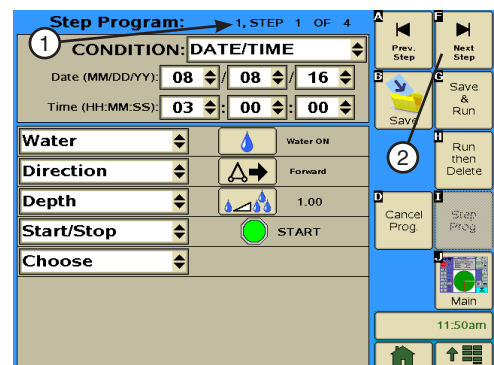

Figure 122-3 1. Step Program Identifier
2. Next Step Button

Example 1. Program by Time and Position (continued)

Program STEP 2 - Example 1

6. Program the position condition for this step. Refer to Figure 123-1.
 - a) Select the **Condition** field and choose **Position**.
 - b) Select the **Degrees** field, enter **1, 8, 0** for 180 degrees and push **Enter**.
7. Enter the commands to execute at this position.
 - a) Select the next **Command** field, choose **Water**, and use the default setting of **Water Off**.
 - b) Select the next **Command** field and choose **Percentage**.
 - c) Push the **Percentage** Button, enter **1, 0, 0** for 100 percent, and push **Enter**.
8. Push **Next Step** to add step 3.

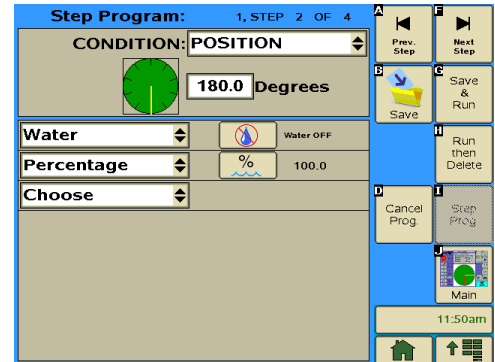

Figure 123-1

Program STEP 3 - Example 1

9. Program the position condition for this step. Refer to Figure 123-2.
 - a) Select the **Condition** field and choose **Position**.
 - b) Select the **Degrees** field, enter **2, 2, 5** for 225 degrees, and push **Enter**.
10. Enter the commands to be executed at this position.
 - a) Select the **Command** field and choose **Water**.
 - b) Push the **Water** button to set the command to Water On.
 - c) Select the next **Command** field and choose **Depth**.
 - d) Push the **Depth** button, enter **., 7, 5** for 0.75 inches, and push the **Enter** button..
11. Push **Next Step** to add step 4.



Figure 123-2

Program STEP 4 - Example 1

12. Program the position condition for this step. Refer to Figure 123-3.
 - a) Select the **Condition** field.
 - b) Choose **Position** as the Condition for this step and use the default setting of **0.0** degrees.
13. Enter the command to be executed at this position.
 - a) Select the **Command** field, choose **Start/Stop**, and use the default setting of **Stop**.

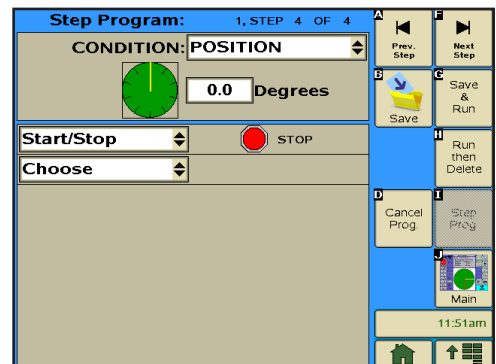

Figure 123-3

All of the steps have been created for this program. Continue with **Finish Programming**.

Step Program Examples

Example 1. Program by Time and Position (continued)

Finish Programming

14. Finish the program by selecting one of the following.
 - Push **Save** to save the program.
 - Push **Save & Run** to save and then run the program.
 - Push **Run Then Delete** to run the program once and then delete it.
 - Push **Cancel Prog** to cancel the program.

Step Program Examples

Example 2. Program by Day and Time

In this program example, the machine is being programmed to start on specific days and time, water one half of the field, turn the water off, and increase speed over set aside acres. It then turns the water on, sets the depth, and waters the remaining half of the field, stopping at 0°. Refer to Figure 125-1.

Current Machine Condition:

- Machine is OFF at 0°.

Program Machine By:

- Day and Time: ON Mondays, Wednesdays, and Fridays at 3:00 AM, WATER ON, FORWARD, Depth 1.00", START.
- Position: At 180°, WATER OFF, Percent 100.
- Position: At 225°, WATER ON, Depth 0.75".
- Position: At 0°, STOP.

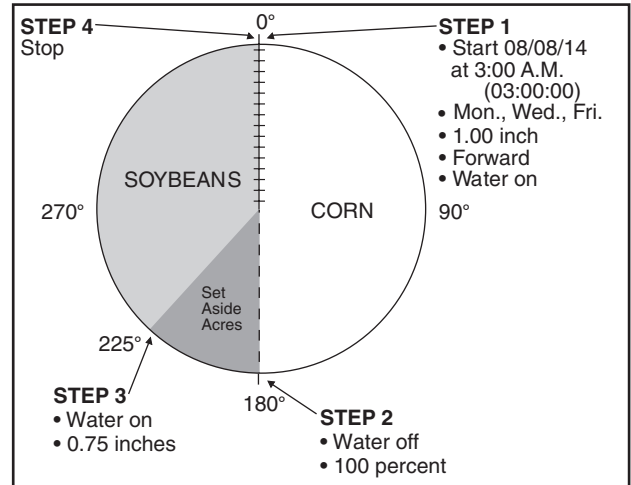

Figure 125-1

Start Programming

To program Example 2, follow these steps.

1. Push **Prog.** and **Step Prog.** to view the Step Program screen. Refer to Figure 125-2.
2. Push the **New** button.
3. Select the **New Program** field and choose the Program Number.
4. Push the **Enter** button.

Program STEP 1 - Example 2

5. Program the day and time for this step. Refer to Figure 125-3.
 - a) Select the **Condition** field and choose **Day/Time**.
 - b) Choose the days by checking the **Monday, Wednesday and Friday** check boxes.
 - c) Select the **HH/MM/SS Time** fields one at a time and choose 03, 00, 00 for 3:00 AM.
6. Enter the commands to execute on Mondays, Wednesdays, and Fridays at 3:00 AM.
 - a) Select the **Command** field and choose **Water**.
 - b) Push the **Water** button to set the command to Water On.
 - c) Select the next **Command** field and choose **Direction**.
 - d) Push the **Direction** button to set the command to Forward.
 - e) Select the next **Command** field and choose **Depth**.
 - f) Push the **Depth** button, enter 1, ., 0, 0 for 1.00 inches, and push **Enter**.
 - g) Select the next **Command** field and choose **Start/Stop**.
 - h) Push the **Start/Stop** button to set the command to Start.
 - i) Push **Next Step** to add step 2.

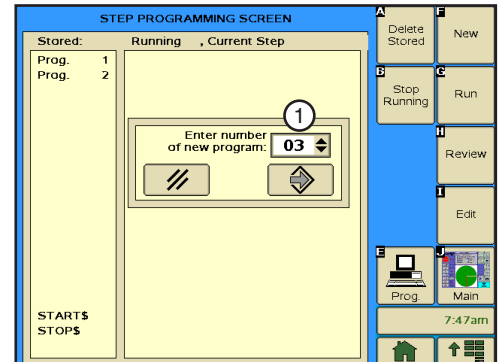

Figure 125-2 1. New Program Number Field

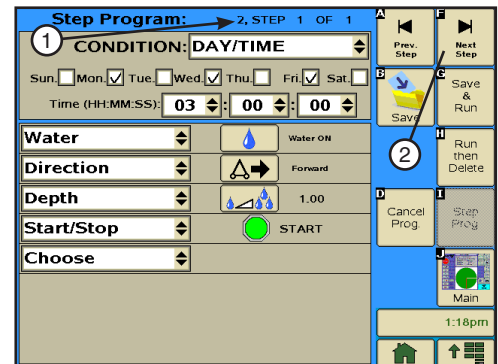

Figure 125-3 1. Step Program Identifier
 2. Next Step Button

Step Program Examples

Example 2. Program by Day and Time (continued)

Program STEP 2 - Example 2

7. Program the position condition for this step. Refer to Figure 126-1.
 - a) Select the **Condition** field and choose **Position**.
 - b) Select the **Degrees** field, enter **1, 8, 0** for 180 degrees, and push the **Enter** button.
8. Enter the commands to be executed at this position. Each command appears on the screen when entered.
 - a) Select the **Command** field, choose **Water**, and use the default setting of **Water Off**.
 - b) Select the next **Command** field and choose **Percentage**.
 - c) Push the **Percentage** Button, enter **1, 0, 0** for 100 percent and push the **Enter** button.
9. Push **Next Step** to add step 3.

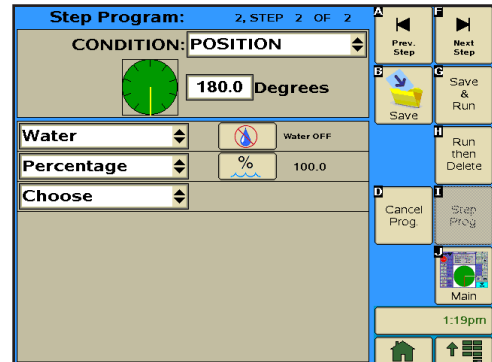

Figure 126-1

Program STEP 3 - Example 2

10. Program the position condition for this step. Refer to Figure 126-2.
 - a) Select the **Condition** field and choose **Position**.
 - b) Select the **Degrees** field, enter **2, 2, 5** for 225 degrees, and push Enter.
11. Enter the commands to be executed at this position.
 - a) Select the **Command** field and choose **Water**.
 - b) Push the **Water** button to set the command to Water On.
 - c) Select the next **Command** field and choose **Depth**.
 - d) Push the **Depth** button, enter **, 7, 5** for 0.75 inches, and push the **Enter** button.
12. Push **Next Step** to add step 4.

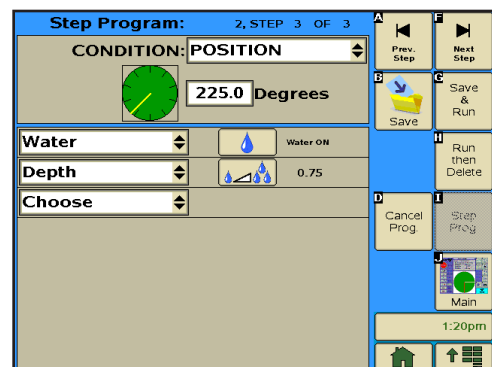

Figure 126-2

Program STEP 4 - Example 2

13. Program the position condition for this step. Refer to Figure 126-3.
 - a) Select the **Condition** field and choose **Position** as the Condition for this step.
 - b) Use the default setting of **0.0** degrees.
14. Enter the command to be executed at this position.
 - a) Select the **Command** field and choose **Start/Stop**.
 - b) Use the default setting of **Stop**.

All of the steps have been created for this program. Continue with **Finish Programming**.



Figure 126-3

Example 2. Program by Day and Time (continued)

Finish Programming

15. Finish the program by selecting one of the following.
 - Push **Save** to save the program.
 - Push **Save & Run** to save and then run the program.
 - Push **Run Then Delete** to run the program once and then delete it.
 - Push **Cancel Prog** to cancel the program.

Step Program Examples

Example 3. Program by Date/Time and Position with SIS On

In this programming example, the machine is programmed to start at a specific date and time. Water one quarter of the field, turn AUX1 ON and increase speed over one half of the field, then turn AUX1 OFF, slow down and SIS ON to water the remaining quarter of the field. The SIS is set at 90°. Refer to Figure 128-1.

Current Conditions:

- Machine OFF at 90°.
- SIS is ON and set at 90°.

Program Machine By:

- Date/Time: On 08/08/14 at 3:00 AM, Water ON, FORWARD, Depth 0.75", Start.
- Position: At 180°, Aux1 ON, Percent 100.
- Position: At 0°, Aux1 OFF, Depth to 0.75".

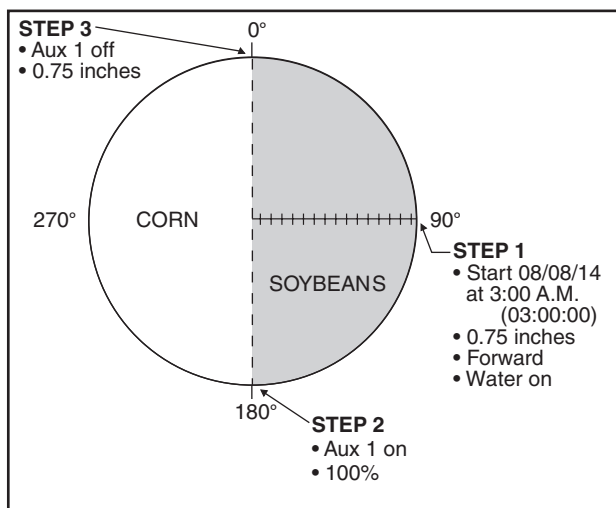

Figure 128-1

Start Programming

To program Example 3, follow these steps.

1. Push **Prog.** and **Step Prog.** to view the Step Program screen. Refer to Figure 128-2.
2. Push the **Enter** button.
3. Select the **New Program** field and choose the Program Number.
4. Push **Enter**.

Program STEP 1 - Example 3

5. Program the start time on a date and time. Refer to Figure 128-3.
 - a) Select the **Condition** field and choose **Date/Time**.
 - b) Select the **MM/DD/YY Date** fields one at a time and choose 08, 08, 16 for August 8, 2016.
 - c) Select the **HH/MM/SS Time** fields one at a time and choose 03, 00, 00 for 3:00 AM.
6. Enter the commands to execute on 08/08/16 at 3:00 AM.
 - a) Select the **Command** field and choose **Water**.
 - b) Push the **Water** button to set the command to Water On.
 - c) Select the next **Command** field and choose **Direction**.
 - d) Push the **Direction** button to set the command to Forward.
 - e) Select the next **Command** field and choose **Depth**.
 - f) Push the **Depth** button, enter ., 7, 5 for .75 inches, and push the **Enter** button.
 - g) Select the next **Command** field and choose **Start/Stop**.
 - h) Push the **Start/Stop** button to set the command to Start.
 - i) Push **Next Step** to add step 2.

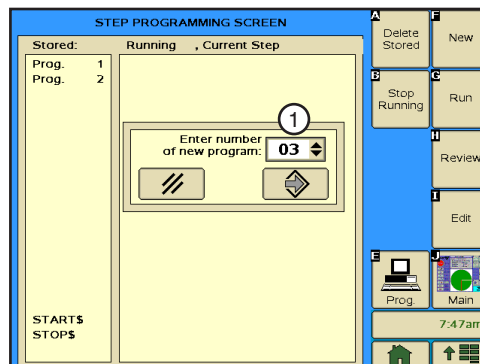

Figure 128-2 1. New Program Number Field



Figure 128-3 1. Step Program Identifier
2. Next Step Button

Example 3. Program by Date/Time and Position with SIS On (continued) Program STEP 2 - Example 3

7. Program the position condition for this step. Refer to Figure 129-1.
 - a) Select the **Condition** field and choose **Position**.
 - b) Select the **Degrees** field, enter **1, 8, 0** for 180 degrees, and push **Enter**.
8. Enter the commands to be executed at this position. Each command appears on the screen when entered.
 - a) Select the **Command** field and choose **Aux 1**.
 - b) Push the **Aux 1** button and set to Aux 1 On.
 - c) Select the next **Command** field and choose **Percentage**.
 - d) Push the **Percentage** Button, enter **1, 0, 0** for 100 percent, and push **Enter**.
9. Push **Next Step** to add step 3.

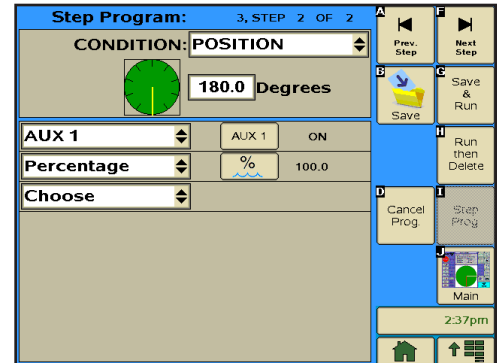

Figure 129-1

Program STEP 3 - Example 3

10. Program the position condition for this step. Refer to Figure 129-2.
 - a) Select the **Condition** field, choose **Position** as the Condition for this step, and use the default setting of **0.0** degrees.
11. Enter the commands to be executed at this position.
 - a) Select the **Command** field, choose **Aux 1**, and use the default setting of **Off**.
 - b) Select the next **Command** field and choose **Depth**.
 - c) Push the **Depth** button, enter **., 7, 5** for 0.75 inches and push the **Enter** button.
 - d) Select the next **Command** field and choose **Stop In Slot**.
 - e) Push the **Stop-In-Slot** button to turn Stop-In-Slot (SIS) On. The SIS position is set on the Main screen.



Figure 129-2

All of the steps have been created for this program. Continue with **Finish Programming**.

Finish Programming

12. Finish the program by selecting one of the following.
 - Push **Save** to save the program.
 - Push **Save & Run** to save and then run the program.
 - Push **Run Then Delete** to run the program once and then delete it.
 - Push **Cancel Prog** to cancel the program.

Step Program Examples

Example 4. Program by Position and Delay

In this example, the machine is being programmed to REVERSE at 270° and STOP at 90°. End-of-field stop/ auto reverse is not being used since there are no physical obstacles in the field. Refer to Figure 130-1.

Current Conditions:

- Machine RUNNING at 90°; FORWARD; 50 percent; WATER ON.

Program Machine By:

- Position: At 180°, Percent 80.
- Position: At 270°, REVERSE, Percent 0.
- Delay: After 600 seconds (10 minutes), Percent 50. (600 second delay to improve water uniformity at reverse point).
- Position: At 180°, Percent 80.
- Position: At 90°, Percent 0
- Delay: After 600 seconds, STOP. (600 second delay to improve water uniformity at stopping point).

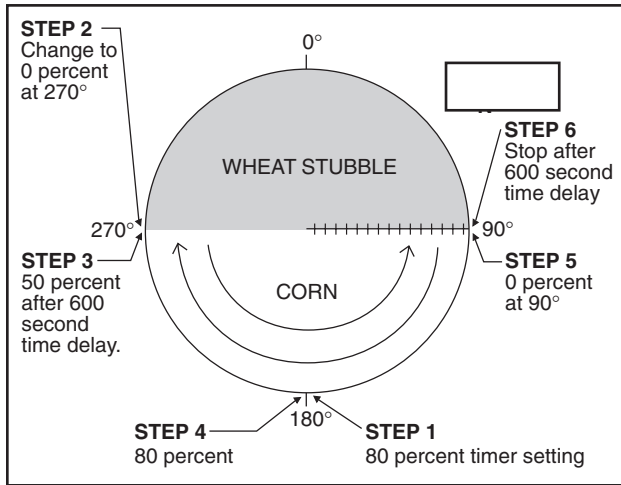

Figure 130-1

Start Programming

To program Example 4, follow these steps.

- Push **Prog.** and **Step Prog.** to view the Step Program screen. Refer to Figure 130-1.
- Push the **New** button.
- Select the **New Program** field and choose the Program Number.
- Push the **Enter** button.

Program STEP 1 - Example 4

- Program the position condition for this step. Refer to Figure 130-2.
 - Select the **Condition** field and choose **Position**.
 - Select the **Degrees** field, enter **1, 8, 0** for 180 degrees and push the **Enter** button.
- Enter the command to be executed at this position. Refer to Figure 130-3.
 - Select the next **Command** field and choose **Percentage**.
 - Push the **Percentage** Button, enter **8, 0** for 80 percent and push the **Enter** button.
- Push **Next Step** to add step 2.

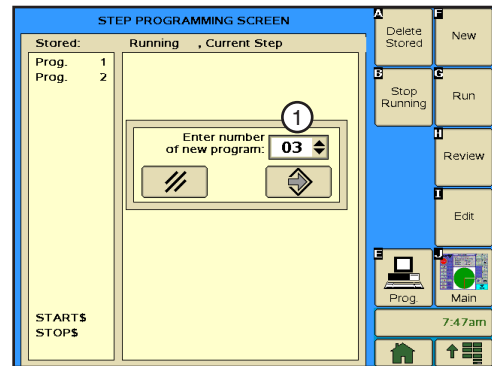

Figure 130-2 1. New Program Number Field

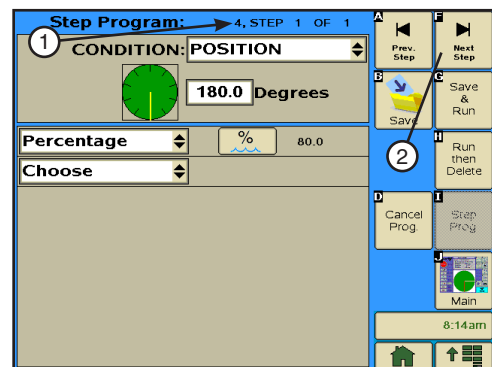

Figure 130-3 1. Step Program Identifier
2. Next Step Button

Example 4. Program by Position and Delay (continued)

Program STEP 2 - Example 4

8. Program the position condition for this step. Refer to Figure 131-1.
 - a) Select the **Condition** field and choose **Position**.
 - b) Select the **Degrees** field, enter **2, 7, 0** for 270 degrees and push the **Enter** button.
9. Enter the commands to be executed at this position.
 - a) Select the **Command** field, choose **Direction**, and use the default setting of **Reverse**.
 - b) Select the next **Command** field, choose **Percentage**, and use the default setting of **0.0**.
10. Push **Next Step** to add step 3.

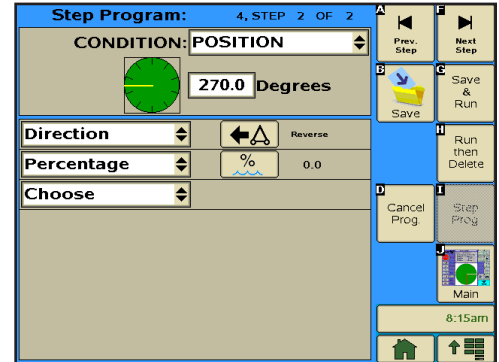

Figure 131-1

Program STEP 3 - Example 4

11. Program the delay time condition for this step. Refer to Figure 131-2.
 - a) Select the **Condition** field and choose **Delay**.
 - b) Select the **Delay Mode** field and choose **Seconds** as the mode.
 - c) Select the **Delay Time** field, enter **6, 0, 0** for 600 seconds, and push the **Enter** button.

NOTE: A delay only counts as down time when the power is ON.
12. Enter the command to be executed after the delay.
 - a) Select the **Command** field and choose **Percentage**.
 - b) Push the **Percentage** Button, enter **5, 0** for 50 percent and push the **Enter** button.
13. Push **Next Step** to add step 4.

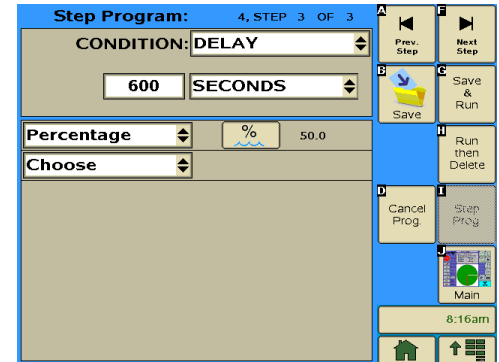

Figure 131-2

Step Program Examples

Example 4. Program by Position and Delay (continued)

Program STEP 4 - Example 4

14. Program the position condition for this step. Refer to Figure 132-1.
 - a) Select the **Condition** field and choose **Position**.
 - b) Select the **Degrees** field, enter **1, 8, 0** for 180 degrees, and push the **Enter** button.
15. Enter the command to be executed at this position.
 - a) Select the **Command** field and choose **Percentage**.
 - b) Push the **Percentage** Button, enter **8, 0** for 80 percent, and push the **Enter** button.
16. Push **Next Step** to add step 5.

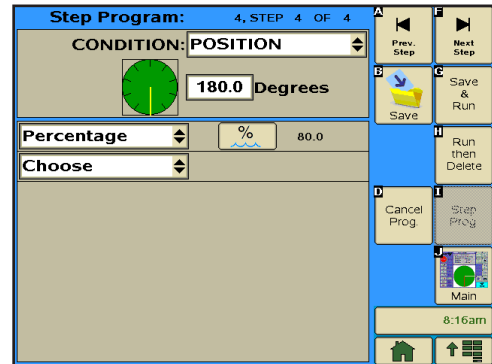

Figure 132-1

Program STEP 5 - Example 4

17. Program the position condition for this step. Refer to Figure 132-2.
 - a) Select the **Condition** field and choose **Position**.
 - b) Select the **Degrees** field, enter **9, 0** for 90 degrees, and push the **Enter** button.
18. Enter the command to be executed at the position.
 - a) Select the **Command** field.
 - b) Choose **Percentage** and use the default setting of **0.0**.
19. Push **Next Step** to add step 6.

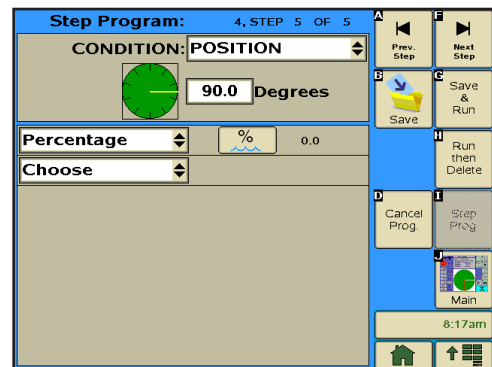

Figure 132-2

Example 4. Program by Position and Delay (continued)

Program STEP 6 - Example 4

20. Program the delay time condition for this step. Refer to Figure 133-1.

- Select the **Condition** field and choose **Delay**.
- Select the **Delay Mode** field and choose **Seconds** as the mode.
- Select the **Delay Time** field, enter **6, 0, 0** for 600 seconds, and push the **Enter** button.

NOTE: A delay only counts as down time when the power is ON.

21. Enter the command to be executed after the delay.

- Select the **Command** field
- Choose **Start/Stop** and use the default setting of **Stop**.

All of the steps have been created for this program. Continue with **Finish Programming**.

Finish Programming

22. Finish the program by selecting one of the following.

- Push **Save** to save the program.
- Push **Save & Run** to save and then run the program.
- Push **Run Then Delete** to run the program once and then delete it.
- Push **Cancel Prog** to cancel the program.



Figure 133-1

Step Program Examples

Example 5. Program by Position, Direction, and Delay

In this example, the Percent Timer is programmed to 0 when the end-of-field stop/auto reverse actuator arms are tripped at 270° and 90°. Allowing the end-of-field stop/auto-reverse hardware to reverse the machine provides more accuracy than programming a position to reverse the machine. Refer to Figure 134-1.

Current Conditions:

- Machine RUNNING at 90°, FORWARD, 50 percent, WATER ON.
- The machine is equipped with end-of-field stop/auto reverse hardware. Barriers are located at 90° and 270° to trip the arms and change machine direction.
- AR/AS delay is set to 0.

Program Machine By:

- Position: At 180°, Percent 80.
- Position: At 270°, Percent 0, REVERSE.
- Delay: After 600 seconds (10 minutes), Percent 50. (600 second delay to improve water uniformity at reverse point).
- Position: At 180°, Percent 80. (machine is traveling in the REVERSE direction).
- Position: At 0°, Percent 0, FORWARD.
- Delay: After 600 seconds, STOP. (600 second delay to improve water uniformity at stopping point)

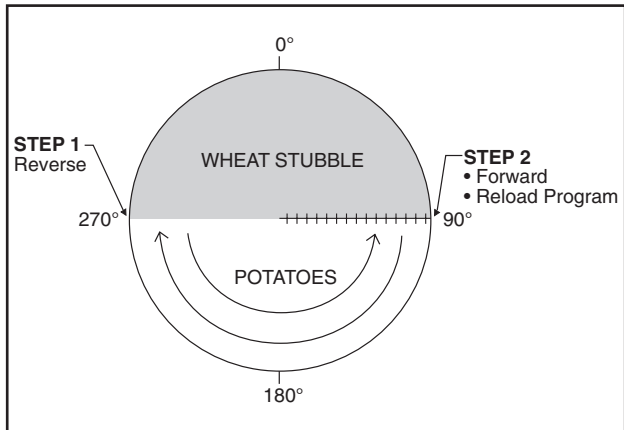

Figure 134-1

Start Programming

To program Example 5, follow these steps.

1. Push **Prog.** and **Step Prog.** to view the Step Program screen. Refer to Figure 134-2.
2. Push the **New** button.
3. Select the **New Program Field** field and choose the Program Number.
4. Push the **Enter** button.

Program STEP 1 - Example 5

5. Program the position condition for this step. Refer to Figure 134-3.
 - a) Select the **Condition** field and choose **Position**.
 - b) Select the **Degrees** field, enter **1, 8, 0** for 180 degrees and push the **Enter** button.
6. Enter the command to be executed at this position.
 - a) Select the **Command** field and choose **Percentage**.
 - b) Push the **Percentage** Button, enter **8, 0** for 80 percent and push the **Enter** button.
7. Push **Next Step** to add step 2.

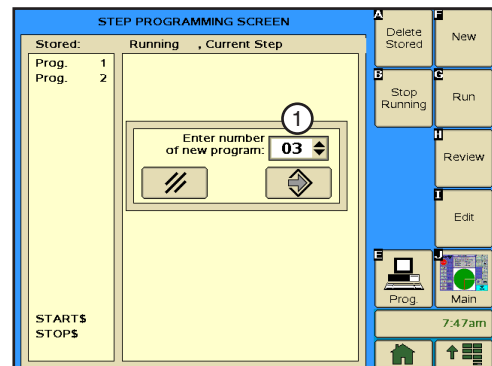

Figure 134-2 1. New Program Number Field

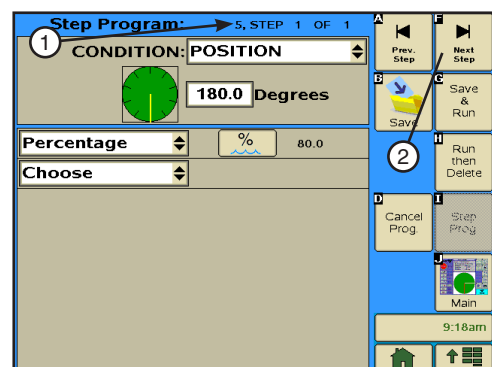

Figure 134-3 1. Step Program Identifier
2. Next Step Button

Example 5. Program by Position, Direction, and Delay (continued)

Program STEP 2 - Example 5

8. Program the direction condition. Refer to Figure 135-1.
 - a) Select the **Condition** field and choose **Direction**.
 - b) Select the **Direction** field and choose **Reverse** as the direction.
9. Enter the command to be executed when the machine changes direction from forward to reverse.
 - a) Select the **Command** field, choose **Percentage**, and use the default setting of **0.0**.
10. Push **Next Step** to add step 3.

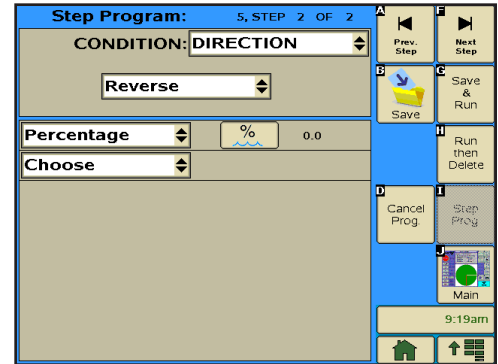

Figure 135-1

Program STEP 3 - Example 5

11. Program the delay time condition for this step. Refer to Figure 135-2.
 - a) Select the **Condition** field and choose **Delay**.
 - b) Select the **Delay Mode** field and choose **Minutes** as the mode.
 - c) Select the **Delay Time** field, enter **1, 0** for 10 minutes and push the **Enter** button.

NOTE: A delay only counts as down time when the power is ON.

12. Enter the command to be executed after the delay.
 - a) Select the **Command** field and choose **Percentage**.
 - b) Push the **Percentage** Button, enter **5, 0** for 50 percent and push the **Enter** button.
13. Push **Next Step** to add step 4.

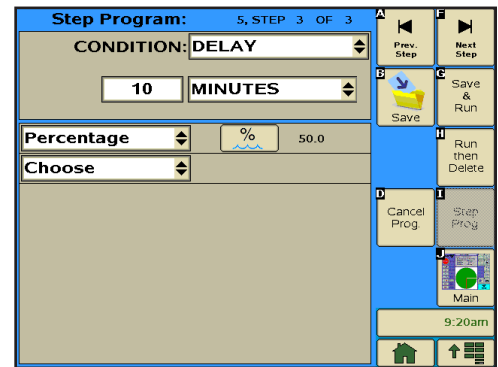

Figure 135-2

Program STEP 4 - Example 5

14. Program the position condition for this step. Refer to Figure 135-3.
 - a) Select the **Condition** field and choose **Position**.
 - b) Select the **Degrees** field, enter **1, 8, 0** for 180 degrees and push the **Enter** button.
15. Enter the command to be executed at this position.
 - a) Select the **Command** field and choose **Percentage**.
 - b) Push the **Percentage** Button, enter **8, 0** for 80 percent and push the **Enter** button.
16. Push **Next Step** to add step 5.

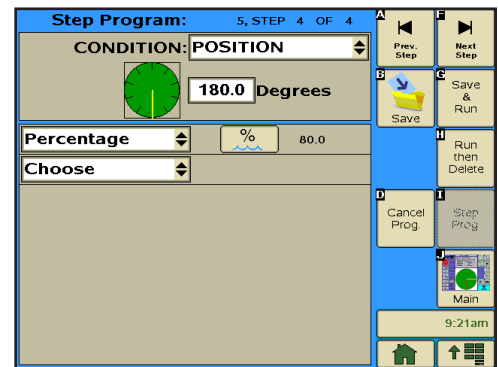

Figure 135-3

Step Program Examples

Example 5. Program by Position, Direction, and Delay (continued)

Program STEP 5 - Example 5

17. Program the direction condition. Refer to Figure 136-1.
 - a) Select the **Condition** field and choose **Direction**.
 - b) Select the **Direction** field and choose **Forward** as the direction.
18. Enter the command to be executed when the machine changes direction from REVERSE to FORWARD.
 - a) Select the **Command** field, choose **Percentage**, and use the default setting of **0.0**.
19. Push **Next Step** to add step 6.

Program STEP 6 - Example 5

20. Program the delay time condition for this step. Refer to Figure 136-2.
 - a) Select the **Condition** field and choose **Delay**.
 - b) Select the **Delay Mode** field and choose **Minutes** as the mode.
 - c) Select the **Delay Time** field, enter **1, 0** for 10 minutes and push the **Enter** button.
- NOTE: A delay only counts as down time when the power is ON.**

21. Enter the command to be executed after the delay.
 - a) Select the **Command** field, choose **Start/Stop**, and use the default setting of **Stop**.

All of the steps have been created for this program. Continue with **Finish Programming**.

Finish Programming

22. Finish the program by selecting one of the following.
 - Push **Save** to save the program.
 - Push **Save & Run** to save and then run the program.
 - Push **Run Then Delete** to run the program once and then delete it.
 - Push **Cancel Prog** to cancel the program.

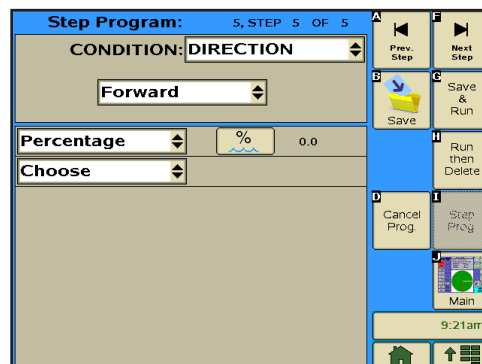

Figure 136-1

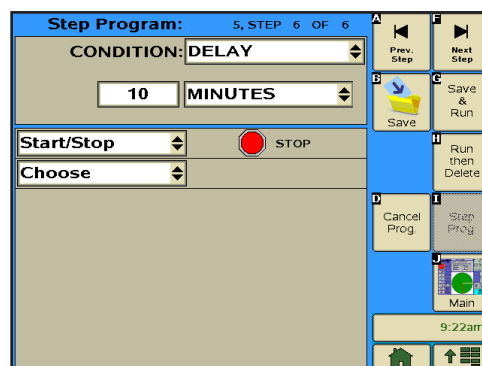

Figure 136-2

Example 6. Program by Pressure

In this example, the machine is programmed by pressure to compensate for reduced flow rate/low pressure due to draw-down of the well. The program must be loaded with the pressure reading on the screen greater than 25 psi, otherwise the program executes immediately as soon as it is run. The program runs only one time. If the pressure returns to 33 psi, the machine still continues to run at 44 percent. A second program can be created that looks for a pressure higher than 30 psi and sets the machine back to 50 percent.

Several variables are involved when trying to determine an adjustment to machine speed based on the operating pressure. Several of these include field elevations and the use of pressure regulators. Valmont Irrigation is not responsible for a degradation of water uniformity caused by adjusting the speed of the machine based on pressure readings at the pivot. Contact your local Valley dealer for further information regarding this subject.

Current Conditions:

- Machine is operating at 33 psi water pressure.
- After 4-5 hours, the draw-down of the well increases, causing the pressure to drop approximately 8 psi.

Program Machine By:

- Pressure: when the pressure drops below 25 psi, set the percent to 44. This may help compensate for the reduced flow rate due to a drop in pressure.

Start Programming

To program Example 6, follow these steps.

1. Push **Prog.** and **Step Prog.** to view the Step Program screen. Refer to Figure 137-1.
2. Push the **New** button.
3. Select the **New Program Number** field and choose the Program Number.
4. Push the **Enter** button.

Program STEP 1 - Example 6

5. Program the pressure condition for this step. Refer to Figure 137-2.
 - a) Select the **Condition** field and choose **Pressure**.
 - b) Select the **Limit** field and choose **Lower**.
 - c) Select the **Psi** field, enter **2, 5** for 25 psi., and push the **Enter** button.
6. Enter the command to be executed when the water pressure drops below 25 psi. Refer to Figure 137-4.
 - a) Select the **Command** field and choose **Percentage**.
 - b) Push the **Percentage** Button, enter **4, 4** for 44 percent and push the **Enter** button.

All of the steps have been created for this program. Continue with **Finish Programming**.

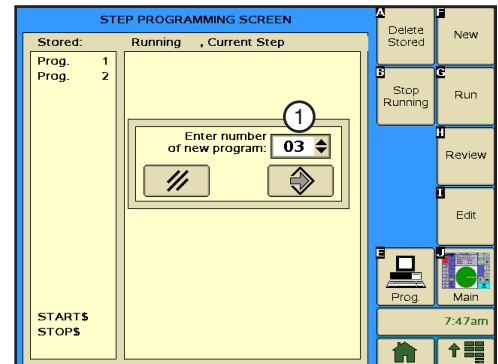

Figure 137-1 1. New Program Number Field

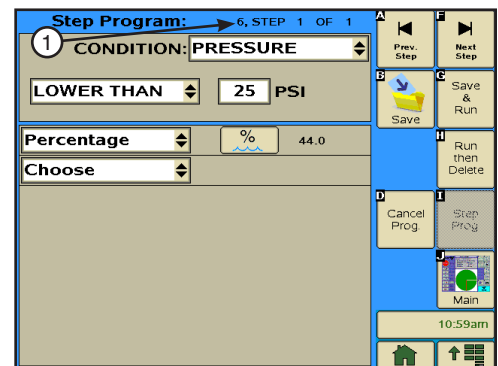

Figure 137-2 1. Step Program Identifier

Step Program Examples

Example 6. Program by Pressure (continued)

Finish Programming

7. Finish the program by selecting one of the following.
 - Push **Save** to save the program.
 - Push **Save & Run** to save and then run the program.
 - Push **Run Then Delete** to run the program once and then delete it.
 - Push **Cancel Prog** to cancel the program.

Step Program Examples

Example 7. Program by Position, Module, and Delay

Module is another name for a relay. The machine is controlled by a series of relays located in the control panel. Each relay is either closed (ON) or open (OFF) as the machine is operating. The machine can be programmed to perform commands based on the condition of any one of these relays. Refer to Figure 139-1.

Following is a list of the modules:

0	Safety Out	13	Low Side 1
1	Percent Timer	14	Low Side 2
2	End Gun	15	Not Used
3	Wide Boundary	16	Remote Start
4	Pump Safety	17	Pressure Switch
5	Alarm	18	3 Second timer
6	Auxiliary 1 Output	19	Auxiliary 2 Input
7	Auxiliary 2 Output	20	Auxiliary 1 Input
8	Contact Enable	21	Reverse Sense
9	Direction (Fwd=ON, Rev=OFF)	22	Forward Sense
10	Control Panel Backlight	23	Safety Sense
11	TTL Output 2	24	PC4
12	TTL Output 1	25	PC5

Modules #21 Reverse Sense and #22 Forward Sense are used to demonstrate how to program by module instead of forward/reverse.

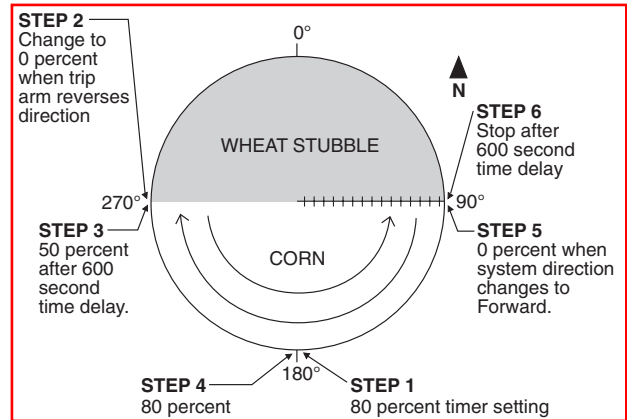

Figure 139-1

Current Conditions:

- Machine RUNNING at 90°, FORWARD, 50 percent, WATER ON
- The machine is equipped with end-of-field stop/autoreverse hardware. Barriers are located at 90° and 270° to trip the arms and change machine direction.

Program Machine By:

- Position: At 180°, Percent 80.
- Position: At 270°, Percent 0 (the arm trips and reverses the machine).
- Delay: At 600 seconds, Percent 50 (10 minute delay to improve water uniformity at reverse point).
- Position: At 180°, Percent 80 (machine is travelling in the REVERSE direction).
- Position: At 90°, Percent 0.
- Delay: At 600 seconds, STOP.

Start Programming

To program Example 7, follow these steps.

1. Push **Prog.** and **Step Prog.** to view the Step Program screen. Refer to Figure 139-2.
2. Push the **New** button.
3. Select the **New Program Number** field and choose the Program Number.
4. Push the **Enter** button.

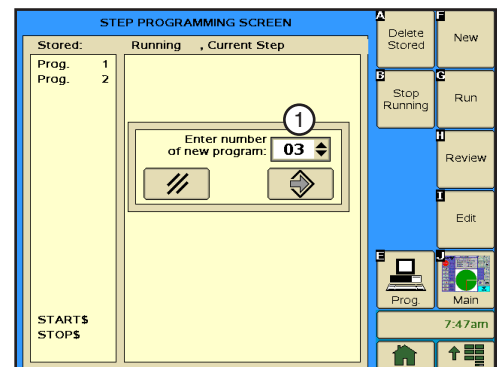

Figure 139-2 1. New Program Number Field

Step Program Examples

Example 7. Program by Position, Module, and Delay (continued)

Program STEP 1 - Example 7

5. Program the position condition for this step. Refer to Figure 140-1.
 - a) Select the **Condition** field and choose **Position**.
 - b) Select the **Degrees** field, enter **1, 8, 0** for 180 degrees and push the **Enter** button.
6. Enter the command to be executed at this position.
 - a) Select the **Command** field and choose **Percentage**.
 - b) Push the **Percentage** Button, enter **8, 0** for 80 percent and push the **Enter** button.
7. Push **Next Step** to add step 2.

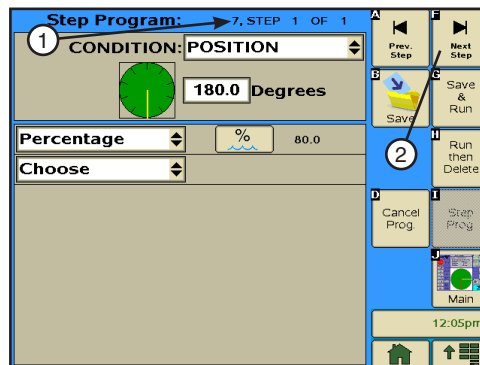

Figure 140-1 1. Step Program Identifier
2. Next Step Button

Program STEP 2 - Example 7

8. Program the module condition for this step. Refer to Figure 140-2.
 - a) Select the **Condition** field and choose **Module**.
 - b) Select the **Module** field and choose **21 Reverse Sense**.
 - c) Select the **On/Off** field and choose **ON**.
9. Enter the command to be executed when the machine contacts the barrier and changes direction from FORWARD to REVERSE and module 21 is ON.
 - a) Select the **Command** field, choose **Percentage**, and use the default setting of **0.0**.
10. Push **Next Step** to add step 3.

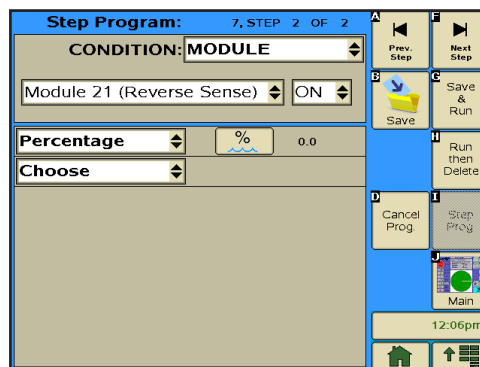

Figure 140-2

Program STEP 3 - Example 7

11. Program the delay time condition for this step. Refer to Figure 140-3.
 - a) Select the **Condition** field and choose **Delay**.
 - b) Select the **Delay Mode** field and choose **Minutes** as the mode.
 - c) Select the **Delay Time** field, enter **1, 0** for 10 minutes and push the **Enter** button.

NOTE: A delay only counts as down time when the power is ON.
12. Enter the command to be executed after the delay.
 - a) Select the **Command** field and choose **Percentage**.
 - b) Push the **Percentage** Button, enter **5, 0** for 50 percent and push the **Enter** button.
13. Push **Next Step** to add step 4.

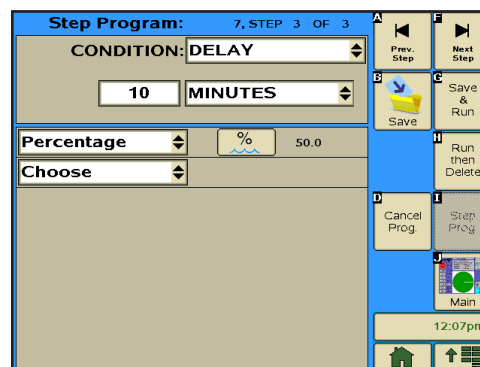

Figure 140-3

Example 7. Program by Position, Module, and Delay (continued)

Program STEP 4 - Example 7

14. Program the position condition for this step. Refer to Figure 141-1.
 - a) Select the **Condition** field and choose **Position**.
 - b) Select the **Degrees** field, enter **1, 8, 0** for 180 degrees, and push the **Enter** button.
15. Enter the command to be executed at this position.
 - a) Select the **Command** field and choose **Percentage**.
 - b) Push the **Percentage** Button, enter **8, 0** for 80 percent, and push the **Enter** button.
16. Push **Next Step** to add step 5.

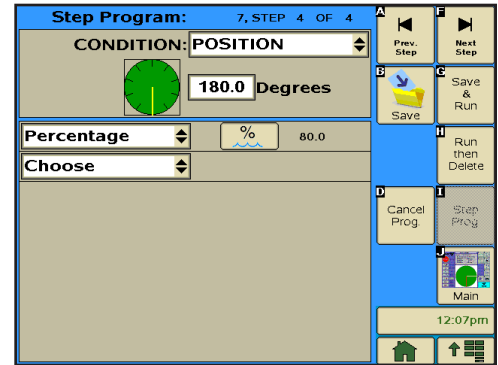

Figure 141-1

Program STEP 5 - Example 7

17. Program the module condition for this step. Refer to Figure 141-2.
 - a) Select the **Condition** field and choose **Module**.
 - b) Select the **Module** field and choose **22 Forward Sense**.
 - c) Select the **On/Off** field and choose **ON**.
18. Enter the command to be executed when the machine contacts the barrier and changes direction from REVERSE to FORWARD.
 - a) Select the **Command** field, choose **Percentage** and use the default setting of **0.0**.
19. Push **Next Step** to add step 6.

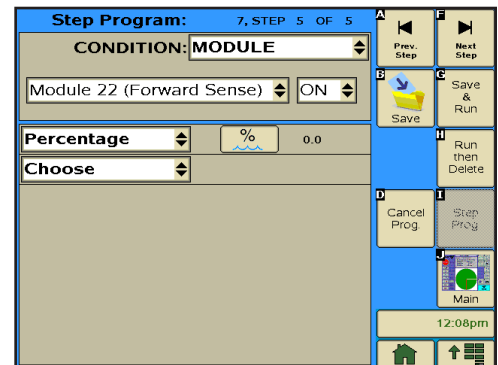

Figure 141-2

Program STEP 6 - Example 7

20. Program the delay time condition for this step. Refer to Figure 141-3.
 - a) Select the **Condition** field and choose **Delay**.
 - b) Select the **Delay Mode** field and choose **Minutes** as the mode.
 - c) Select the **Delay Time** field, enter **1, 0** for 10 minutes, and push the **Enter** button.

NOTE: A delay only counts as down time when the power is ON.
21. Enter the command to be executed after the delay.
 - a) Select the **Command** field, choose **Start/Stop**, and use the default setting of **Stop**.

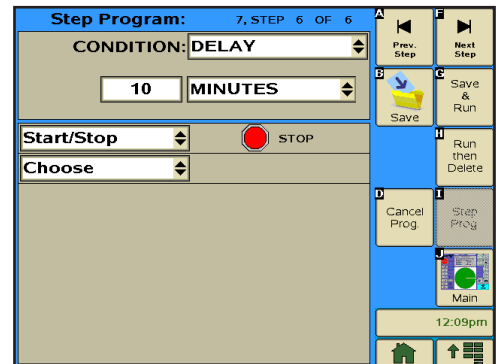

Figure 141-3

All of the steps have been created for this program. Continue with **Finish Programming**.

Step Program Examples

Example 7. Program by Position, Module, and Delay (continued)

Finish Programming

22. Finish the program by selecting one of the following.

- Push **Save** to save the program.
- Push **Save & Run** to save and then run the program.
- Push **Run Then Delete** to run the program once and then delete it.
- Push **Cancel Prog** to cancel the program.

Example 8. Program with Percent-of-Percent Timer or Percent-of-Depth

In this example, the Percent Timer will be programmed to 50% of its current setting when the wind speed exceeds 20 mph. This action is not dependent on such things as direction, position, time of day, etc. As a result of this program, when the wind speed reaches 20 mph the Percent Timer will be adjusted from 60% to 30%. This may help reduce water loss.

Current Conditions:

- Machine running, 60%, water on

Program Machine By:

- Wind speed equal to or greater than 20 mph - 50% of 60%

Start Programming

To program Example 8, follow these steps.

1. Push **Prog.** and **Step Prog.** to view the Step Program screen. Refer to Figure 143-1.
2. Push the **New** button.
3. Select the **New Program Number** field and choose the Program Number.
4. Push the **Enter** button.

Program STEP 1 - Example 8

5. To program using the Wind condition. Refer to Figure 143-2.
 - a) Select the **Condition** field and choose **Wind**.
 - b) Select the **Limit** field and choose **Higher Than**.
 - c) Select the **Wind Speed** field, enter **2, 0** for Wind Speed, and push the **Enter** button.
6. Enter the command to be executed when wind speed is higher than 20 mph.
 - a) Select the next **Command** field and choose **% of %**.

NOTE: You can alternately choose to specify a percent of the depth setting by choosing % of Depth (percent of depth).

- b) Select the **% of %** field, enter **5, 0** for 50 percent and push the **Enter** button.

All of the steps have been created for this program. Continue with **Finish Programming**.

Finish Programming

7. Finish the program by selecting one of the following.
 - Push **Save** to save the program.
 - Push **Save & Run** to save and then run the program.
 - Push **Run Then Delete** to run the program once and then delete it.
 - Push **Cancel Prog** to cancel the program.

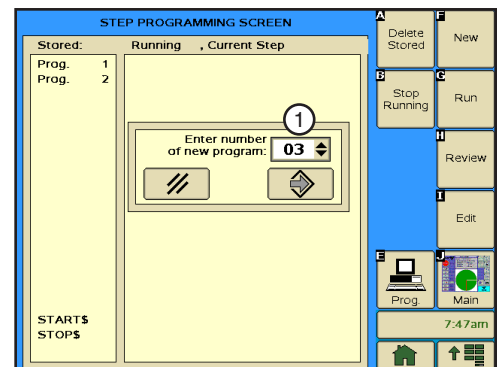

Figure 143-1 1. New Program Number Field

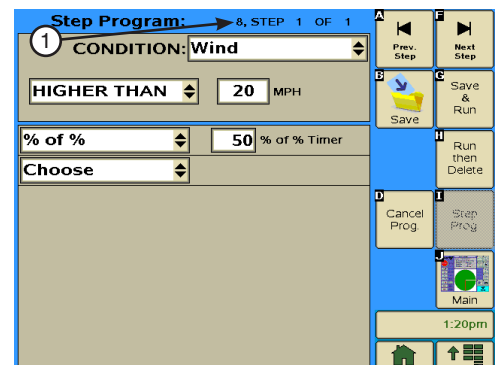

Figure 143-2 1. Step Program Identifier

Step Program Examples

Example 9. Program with Enable/Disable End Guns

In this example, the end gun will be disabled when the wind speed exceeds 20 mph. This action is not dependent on such things as direction, position, time of day, etc.

Current Conditions:

- Machine running, water on, end gun enabled.

Program Machine By:

- Wind speed equal to or greater than 20 mph - end gun disabled

Start Programming

To program Example 9, follow these steps.

1. Push **Prog.** and **Step Prog.** to view the Step Program screen. Refer to Figure 144-1.
2. Push the **New** button.
3. Select the **New Program Number** field and choose the Program Number.
4. Push the **Enter** button.

Program STEP 1 - Example 9

5. To program using the wind condition to enable/disable the End Gun. Refer to Figure 144-2.
 - a) Select the **Condition** field and choose **Wind**.
 - b) Select the **Limit** field and choose **Higher Than**.
 - c) Select the **Wind Speed** field, enter **20** for a Wind Speed of 20 mph, and push the **Enter** button.
6. Enter the command to be executed when wind speed is higher than 20 mph.
 - a) Select the **Command** field
 - b) Choose **Endgun** and use the default setting of **Disabled (unchecked)**.

NOTE: You can alternately choose to enable/disable Wide Boundary, PLC Wide Boundary 2, or Wide Boundary 3.

All of the steps have been created for this program. Continue with **Finish Programming**.

Finish Programming

7. Finish the program by selecting one of the following.
 - Push **Save** to save the program.
 - Push **Save & Run** to save and then run the program.
 - Push **Run Then Delete** to run the program once and then delete it.
 - Push **Cancel Prog** to cancel the program.

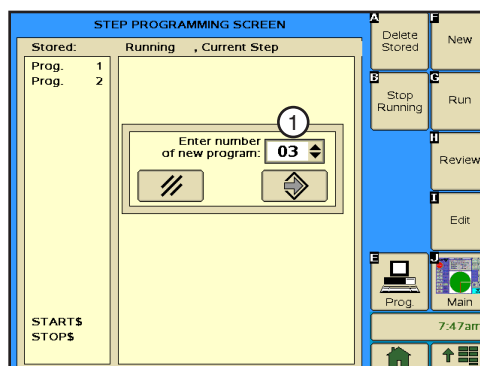

Figure 144-1 1. New Program Number Field



Figure 144-2 1. Step Program Identifier

Step Program Examples

Example 10. Program with Enable/Disable Cruise Control

In this example, the Cruise Control hours will be increased when the wind speed exceeds 20 mph. This action is not dependent on such things as direction, position, time of day, etc.

Current Conditions:

- Machine running, water on, Cruise Control set at 48 hours.

Program Machine By:

- Wind speed equal to or greater than 20 mph - Cruise Control set at 72 hours

NOTE: When Cruise Control is enabled, VRI-Speed is automatically turned off.

Start Programming

To program Example 10, follow these steps.

1. Push **Prog.** and **Step Prog.** to view the Step Program screen. Refer to Figure 145-1.
2. Push the **New** button.
3. Select the **New Program Number** field and choose the program number.
4. Push the **Enter** button.

Program STEP 1 - Example 10

5. To program using the wind condition to enable/disable Cruise Control, do the following. Refer to Figure 145-2.
 - a) Select the **Condition** field and choose **Wind**.
 - b) Select the **Limit** field and choose **Higher Than**.
 - c) Select the **Wind Speed** field, enter 2, 0 for a Wind Speed of 20 mph, and push the **Enter** button.
6. Enter the command to be executed when wind speed is higher than 20 mph.
 - a) Select the **Command** field and choose **Cruise Control**.
 - b) Push the **Cruise Control** button to turn it on. The button changes, and will appear as it does in Figure 145-3.
 - c) Push the **Hrs/Pass** button.
 - d) Enter **7, 2** for 72 hours per revolution and push **Enter**. Refer to Figure 145-4.

All of the steps have been created for this program. Continue with **Finish Programming**.

Finish Programming

7. Finish the program by selecting one of the following.
 - Push **Save** to save the program.
 - Push **Save & Run** to save and then run the program.
 - Push **Run Then Delete** to run the program once and then delete it.
 - Push **Cancel Prog** to cancel the program.

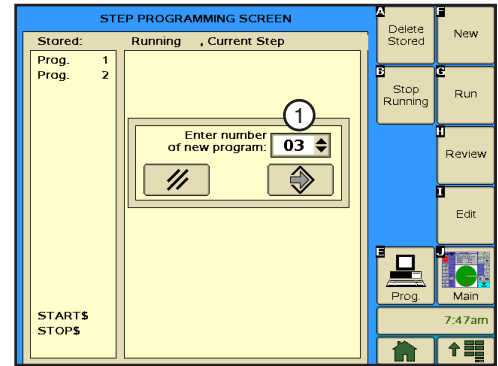

Figure 145-1 1. New Program Number Field



Figure 145-2 1. Step Program Identifier
2. Cruise Control Button

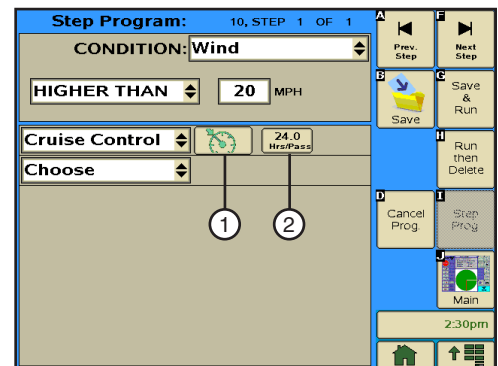

Figure 145-3 1. Cruise Control ON Button
2. Hrs/Pass Button

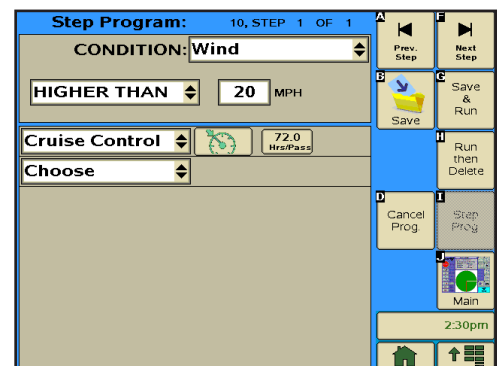

Figure 145-4

Step Program Examples

Example 11. Program with VRI ON/OFF

In this example, VRI will be disabled when the wind speed exceeds 20 mph. At that point, Cruise Control will be enabled and set at 72 hours. This action is not dependent on such things as direction, position, time of day, etc.

Current Conditions:

- Machine running, water on, VRI enabled

Program Machine By:

- Wind speed equal to or greater than 20 mph - VRI off, Cruise Control enabled and set at 72 hours

NOTE: When VRI is enabled, Cruise Control is automatically turned off.

Start Programming

To program Example 11, follow these steps.

1. Push **Prog.** and **Step Prog.** to view the Step Program screen. Refer to Figure 146-1.
2. Push the **New** button.
3. Select the **New Program Number** field and choose the program number.
4. Push the **Enter** button.

Program STEP 1 - Example 11

5. To program using the wind condition to turn VRI Off and enable/disable Cruise Control, do the following. Refer to Figure 146-2.
 - a) Select the **Condition** field and choose **Wind**.
 - b) Select the **Limit** field and choose **Higher Than**.
 - c) Select the **Wind Speed** field, enter 2, 0 for a Wind Speed of 20 mph and push the **Enter** button.
6. Enter the commands to be executed when wind speed is 20 mph or greater.
 - a) Select the **Command** field, choose **VRI ON/OFF**, and use the default setting of **Off**.
 - b) Select the next **Command** field and choose **Cruise Control**.
 - c) Push the **Cruise Control** button to turn it on. The button changes, and will appear as it does in Figure 146-3.
 - d) Push the **Hrs/Pass** button,
 - e) Enter **7, 2** for 72 hours per revolution and push **Enter**. Refer to Figure 146-4.

All of the steps have been created for this program. Continue with **Finish Programming**.

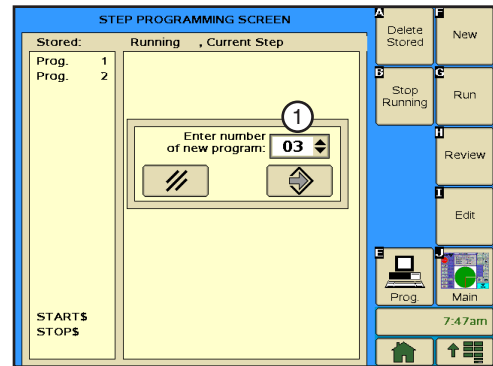

Figure 146-1 1. New Program Number Field



Figure 146-2 1. Step Program Identifier
2. Cruise Control Button



Figure 146-3 1. Cruise Control ON Button
2. Hrs/Pass Button

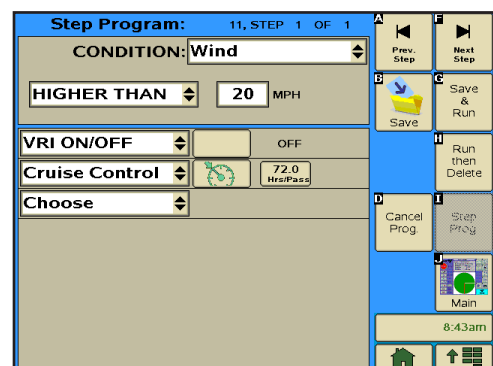

Figure 146-4

Example 11. Program with VRI ON/OFF

Finish Programming

7. Finish the program by selecting one of the following.
 - Push **Save** to save the program.
 - Push **Save & Run** to save and then run the program.
 - Push **Run Then Delete** to run the program once and then delete it.
 - Push **Cancel Prog** to cancel the program.

Step Program Examples

Example 12. Program for a Logging Event

In this example, every time the wind speed exceeds 25 mph, an entry will be made in the event log and displayed on the History Review screens.

Current Conditions:

- Machine running, water on, depth 0.75

Program Machine By:

- Wind speed equal to or greater than 25 mph

Start Programming

To program Example 12, follow these steps.

1. Push **Prog.** and **Step Prog.** to view the Step Program screen. Refer to Figure 148-1.
2. Push the **New** button.
3. Select the **New Program Number** field and choose the program number.
4. Push the **Enter** button.

Program STEP 1 - Example 12

5. To program using the wind condition to initiate a logging event, do the following. Refer to Figure 148-2.
 - a) Select the **Condition** field and choose **Wind**.
 - b) Select the **Limit** field and choose **Higher Than**.
 - c) Select the **Wind Speed** field, enter 2, 5 for a Wind Speed of 25 mph and push the **Enter** button.
6. Enter the command to be executed when wind speed is higher than 25 mph.
 - a) Select the **Command** field and choose **Logging Event**.

All of the steps have been created for this program. Continue with **Finish Programming**.

Finish Programming

7. Finish the program by selecting one of the following.
 - Push **Save** to save the program.
 - Push **Save & Run** to save and then run the program.
 - Push **Run Then Delete** to run the program once and then delete it.
 - Push **Cancel Prog** to cancel the program.

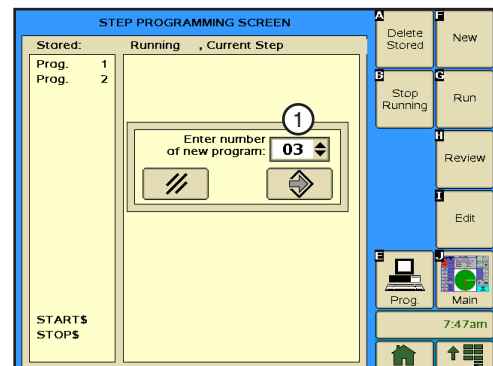

Figure 148-1 1. New Program Number Field

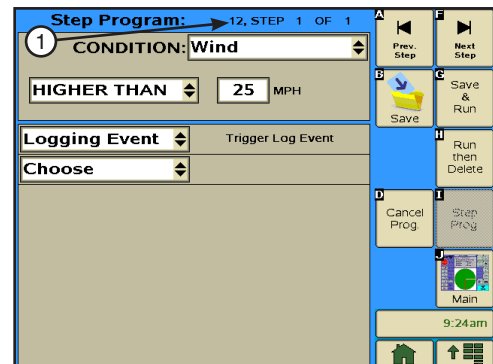

Figure 148-2 1. Step Program Identifier

Step Program Examples

Example 13. Using the Run Program Command

A stored program can be called upon to run from within other programs. For example, program #2 could be run in the last step of program #1, program #3 could be run from program #2, etc. In this example program #1 runs program #2 to repeat the irrigation cycle and then stop at the SIS location. Refer to Figure 149-1.

Current Conditions:

- Machine **RUNNING** at 0°, **FORWARD**, **WATER ON**, Depth 1.00", stop-in-slot is **OFF** and set at 0°.

Program Machine By:

Program 1

- Position: At 180°, **WATER OFF**, Percent 100.
- Position: At 225°, **WATER ON**, Depth 0.75", Run program #2. (Program #2 was already written and stored).

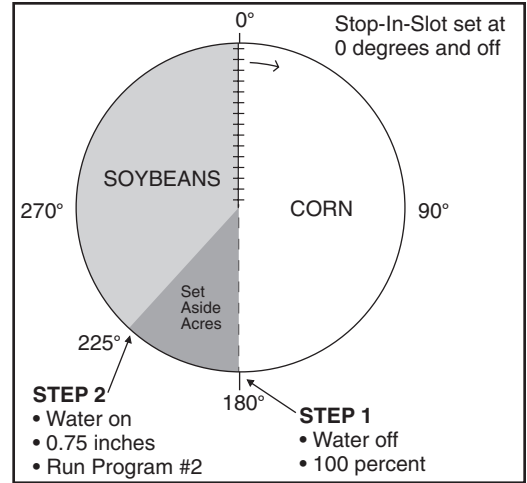

Figure 149-1

Start Programming

To program Example 13, follow these steps.

1. Push **Prog.** and **Step Prog.** to view the Step Program screen. Refer to Figure 149-2
2. Push the **New** button.
3. Select the **New Program Number** field and choose the program number.

4. Push the **Enter** button.

Program STEP 1 - Example 13

5. Program the position condition for this step. Refer to Figure 149-3.
 - a) Select the **Condition** field and choose **Position**.
 - b) Select the **Degrees** field, enter **1, 8, 0** for 180 degrees and push the **Enter** button.
6. Enter the commands to be executed at this position.
 - a) Select the **Command** field, choose **Water**, and use the default setting of **Water Off**.
 - b) Select the next **Command** field and choose **Percentage**.
 - c) Push the **Percentage** Button, enter **1, 0, 0** for 100 percent and push the **Enter** button.
7. Push **Next Step** to add step 2.

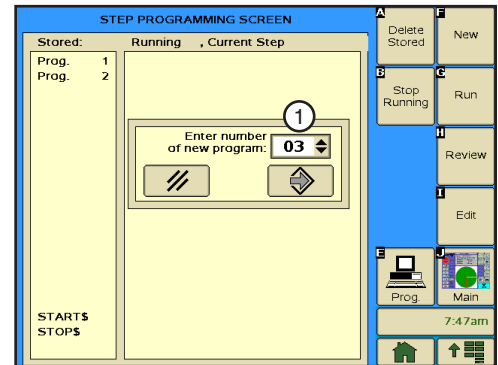

Figure 149-2 1. New Program Number Field

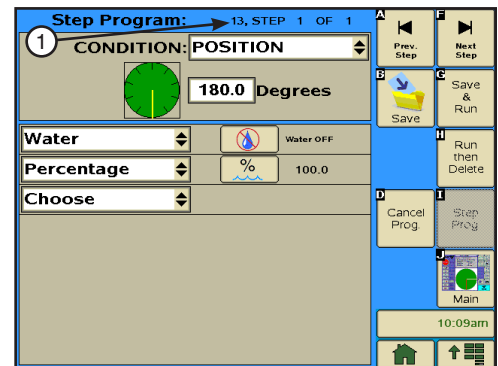

Figure 149-3 1. Step Program Identifier

Step Program Examples

Example 13. Using the Run Program Command (continued)

Program STEP 2 - Example 13

8. Program the position condition for this step. Refer to Figure 150-1.
 - a) Select the **Condition** field and choose **Position**.
 - b) Select the **Degrees** field, enter **2, 2, 5** for 225 degrees, and push **Enter**.
9. Enter the commands to be executed at this position.
 - a) Select the **Command** field and choose **Water**.
 - b) Push the **Water** button to set the command to Water On.
 - c) Select the next **Command** field and choose **Depth**.
 - d) Push the **Depth** button, enter **., 7, 5** for 0.75 inches, and push the **Enter** button.
 - e) Select the next **Command** field and choose **Run Program**.
 - f) Select the **Program Number** field and choose **2** for stored program 2.

All of the steps have been created for this program. Continue with **Finish Programming**.

Finish Programming

10. Finish the program by selecting one of the following.
 - Push **Save** to save the program.
 - Push **Save & Run** to save and then run the program.
 - Push **Run Then Delete** to run the program once and then delete it.
 - Push **Cancel Prog** to cancel the program.

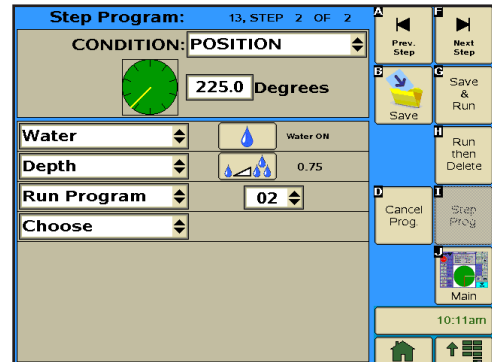

Figure 150-1

Example 13. Using the Run Program Command (continued)

Program Execution

The programs are executed as outlined below:

Program 1

STEP 1: At 180° the machine changes the percentage timer setting to 100 percent, and the water is shut off.

STEP 2: At 225° the water is turned back on and applied at a depth of 0.75" on the soybeans. Program #2 is then loaded and run.

Program 2 (stored program)

STEP 1: At 0° with water already on the depth is set to 1.00".

STEP 2: At 180° turn auxiliary relay #1 off, turn the water off, and turn the stop-in-slot ON at 180°.

STEP 3: At 225° turn water on, set depth to 0.75", and turn stop-in-slot ON.

The machine runs forward with water on applied at a depth of 0.75", then shuts off at 0° which is the stop-in-slot location.

Step Program Examples

Repeating Irrigation Cycles

Example 1. Continuous Auto Reverse Cycles

In this example, a machine is programmed to continuously auto reverse between positions. Refer to Figure 152-1.

⚠ CAUTION

- THIS PROGRAM SHOULD ONLY BE USED FOR AUTO-REVERSING IN OPEN FIELD CONDITIONS WITH NO OBSTACLES PRESENT. IF THE MACHINE NEEDS TO REVERSE AROUND AN OBSTACLE SUCH AS A TREE LINE, BUILDING, OR FENCE, THEN A DRIVE UNIT MOUNTED END-OF-FIELD STOP/AUTO-REVERSE MUST BE INSTALLED WITH PHYSICAL BARRICADES AS A SAFETY BACK-UP.

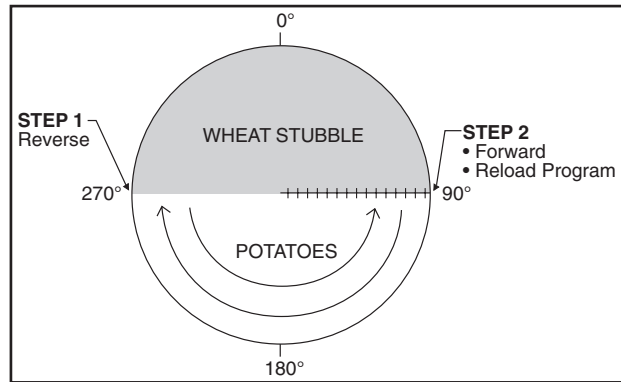

Figure 152-1

Current Conditions:

- Operator manually starts the machine, WATER ON, FORWARD, Depth 1.00".

Program Machine By:

- Position: At 270°, REVERSE.
- Position: At 90°, FORWARD, reload program so the machine reverses again at 270°.

Start Programming

To program Example 1, follow these steps.

1. Push **Prog.** and **Step Prog.** to view the Step Program screen. Refer to Figure 152-2
2. Push the **New** button.
3. Select the **New Program Number** field and choose the program number.
4. push the **Enter** button.

Program STEP 1 - Example 1

5. Program the position condition for this step. Refer to Figure 152-3.
 - a) Select the **Condition** field and choose **Position**.
 - b) Select the **Degrees** field, enter **2, 7, 0** for 270 degrees and push the **Enter** button.
6. Enter the command to be executed at this position.
 - a) Select the **Command** field, choose **Direction**, and use the default setting of **Reverse**.
7. Push **Next Step** to add step 2.

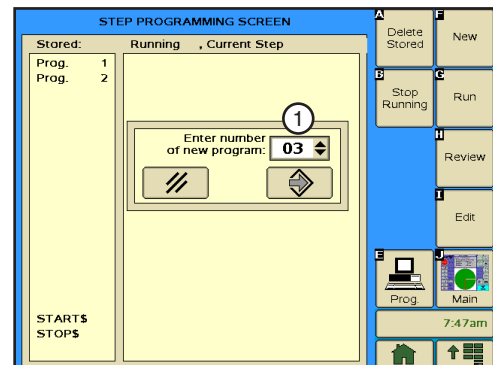

Figure 152-2 1. New Program Number Field

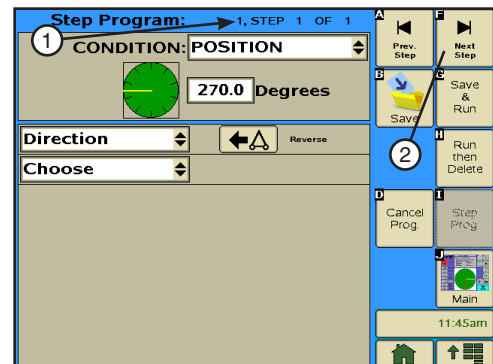

Figure 152-3 2. Step Program Identifier
3. Next Step Button

Repeating Irrigation Cycles

Example 1. Continuous Auto Reverse Cycles (continued)

Program STEP 2 - Example 1

8. Program the position condition for this step. Refer to Figure 153-1.
 - a) Select the **Condition** field and choose **Position**.
 - b) Select the **Degrees** field, enter **9, 0** for 90 degrees, and push the **Enter** button.
9. Enter the commands to be executed at this position.
 - a) Select the **Command** field and choose **Direction**.
 - b) Push the **Direction** button to set the command to Forward.
 - c) Select the next **Command** field and choose **Run Program**.
 - d) Select the **Program Number** field and choose **1** for stored program 1.

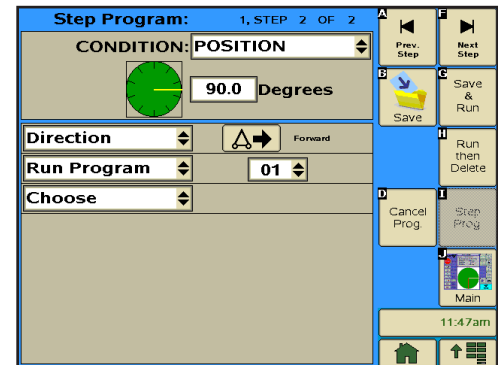

Figure 153-1

All of the steps have been created for this program. Continue with **Finish Programming**.

Finish Programming

10. Finish the program by selecting one of the following.
 - Push **Save** to save the program.
 - Push **Save & Run** to save and then run the program.
 - Push **Run Then Delete** to run the program once and then delete it.
 - Push **Cancel Prog** to cancel the program.

Step Program Examples

Repeating Irrigation Cycles

Example 1. Continuous Auto Reverse Cycles (continued)

Running The Program

To run the program use run stored or save and run program. Either of these methods make the program current.

When the machine is started, the program runs and the machine continues to operate until the program is deleted from current programs, Stop-In Slot or another program stops the machine, or STOP is Pushed.

The only purpose of this program is to change machine direction at 90° and 270°.

This program can run simultaneously with other programs that may start or stop the machine, or change water application depth.

CAUTION

•PROGRAM STEPS ARE EXECUTED IN NUMERIC ORDER. IN THIS EXAMPLE, THE MACHINE MUST TRAVEL TOWARD 270° FIRST AND THEN TOWARD 90°. IF THE DIRECTION OF THE MACHINE IS MANUALLY REVERSED AND THE MACHINE HAS NOT EXECUTED THE CURRENT STEP, THE MACHINE WILL NOT REVERSE PROPERLY.

If the direction of the machine is manually changed from FORWARD to REVERSE before STEP #1 is executed, the following happens.

- The machine travels past 90° in the REVERSE direction to 270°, which is not desired. Refer to Figure 154-1.
- Step #1 is executed but the direction of the machine does not change because it is already be travelling in the REVERSE direction.
- Step #2 is executed normally at 90°, the direction of the machine changes to FORWARD, and the program is reloaded.

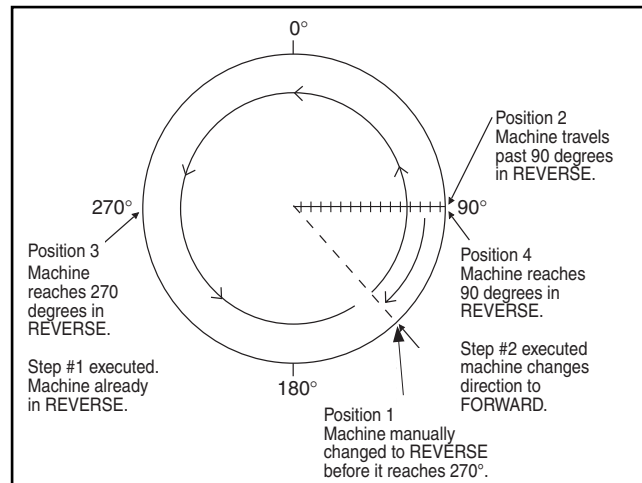

Figure 154-1

Repeating Irrigation Cycles

Example 2. Continuous Wet Area Water Off Cycles

This example illustrates how to turn the water off and change percentage setting, and then turn the water back on and change percentage setting again. This program allows the machine to travel without water at 100 percent over a wet area. Reloading this program in the last step causes this program to be repeated continuously. Refer to Figure 155-1.

Current Conditions:

- Operator manually starts the machine, WATER ON, FORWARD, 50 percent.

Program Machine By:

- Position: At 90°, WATER OFF, Percent 100.
- Position: At 105°, WATER ON, Percent 50, Reload this program.

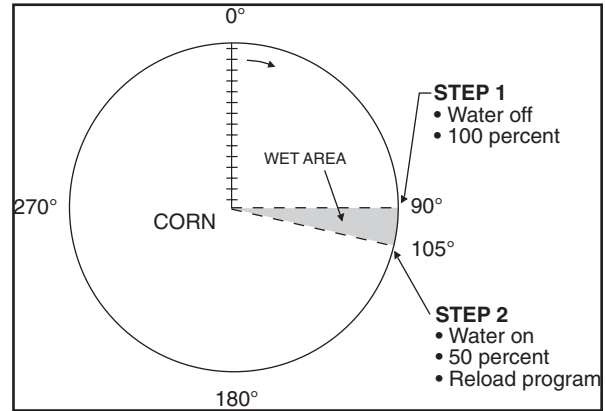

Figure 155-1

Start Programming

To program Example 2, follow these steps.

1. Push **Prog.** and **Step Prog.** to view the Step Program screen. Refer to Figure 155-2
2. Push the **New** button.
3. Select the **New Program Number** field and choose the program number.
4. Push the **Enter** button.

Program STEP 1 - Example 2

5. Program the position condition for this step. Refer to Figure 155-3.
 - a) Select the **Condition** field and choose **Position**.
 - b) Select the **Degrees** field, enter **9, 0** for 90 degrees and push the **Enter** button.
6. Enter the commands to be executed at this position.
 - a) Select the **Command** field, choose **Water**, and use the default setting of **Water Off**.
 - b) Select the next **Command** field and choose **Percentage**.
 - c) Push the **Percentage** Button, enter **1, 0, 0** for 100 percent and push the **Enter** button.
7. Push **Next Step** to add step 2.

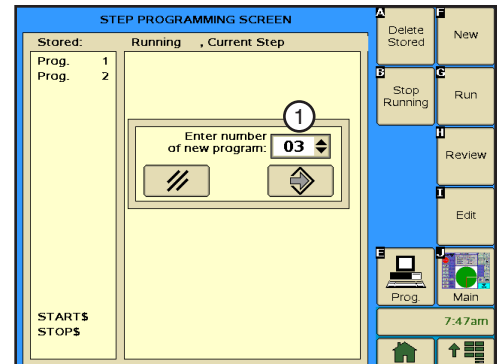

Figure 155-2 1. New Program Number Field

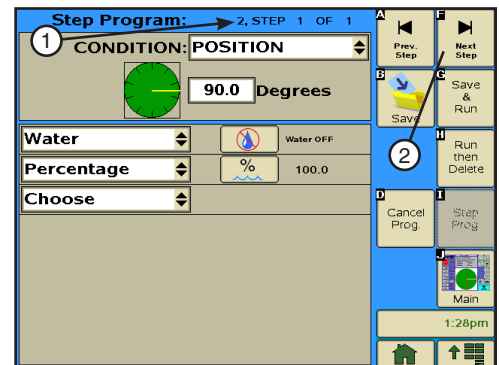

Figure 155-3 1. Step Program Identifier
2. Next Step Button

Step Program Examples

Repeating Irrigation Cycles

Example 2. Continuous Wet Area Water Off Cycles (continued)

Program STEP 2 - Example 2

8. Program the position condition for this step. Refer to Figure 156-1.
 - a) Select the **Condition** field and choose **Position**.
 - b) Select the **Degrees** field, enter **1, 0, 5** for 105 degrees and push the **Enter** button.
9. Enter the commands to be executed at this position.
 - a) Select the **Command** field and choose **Water**.
 - b) Push the **Water** button to set the command to Water On.
 - c) Select the next **Command** field and choose **Percentage**.
 - d) Push the **Percentage** Button, enter **5, 0** for 50 percent and push the **Enter** button.
 - e) Select the next **Command** field and choose **Run Program**.
 - f) Select the **Program Number** field and choose **2** for stored program 2.

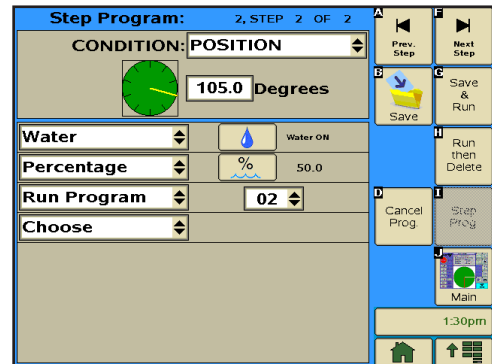

Figure 156-1

All of the steps have been created for this program. Continue with **Finish Programming**.

Finish Programming

10. Finish the program by selecting one of the following.
 - Push **Save** to save the program.
 - Push **Save & Run** to save and then run the program.
 - Push **Run Then Delete** to run the program once and then delete it.
 - Push **Cancel Prog** to cancel the program.

Repeating Irrigation Cycles

Example 3. Using Run Program Command

In this example, the machine needs to complete two identical irrigation cycles and stop at 0°. To accomplish this, two programs are written. Refer to Figure 157-1.

Program #1 starts the machine at 3:00 am on 08/08/14, change the depth to 0.50" At 180°, change the depth to 1.00" At 0°, and load program two to complete the first cycle.

Program #2 changes the depth to 0.50" At 180° and stop the machine at 0° to complete the second cycle.

Program One

Expected Conditions - First Program:

- Machine OFF at 0°.

Program Machine By:

- Time: On 08/08/14 at 3:00:00 AM, FORWARD, Water On, Depth 1.00", Start.
- Position: At 180°, Depth 0.50".
- Position: At 0°, Depth 1.00", Run Program 2.

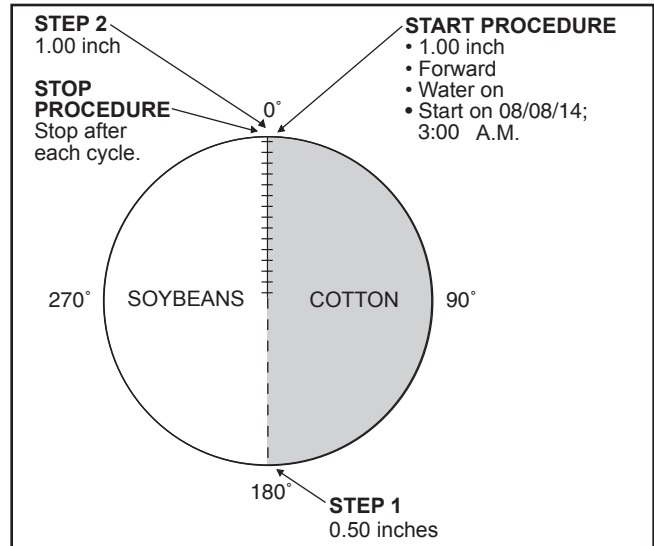

Figure 157-1

Start Programming

To write program one of Example 3, follow these steps.

1. Push **Prog.** and **Step Prog.** to view the Step Program screen. Refer to Figure 157-2.
2. Push the **New** button.
3. Select the **New Program Number** field and choose the program number.
4. Push the **Enter** button.

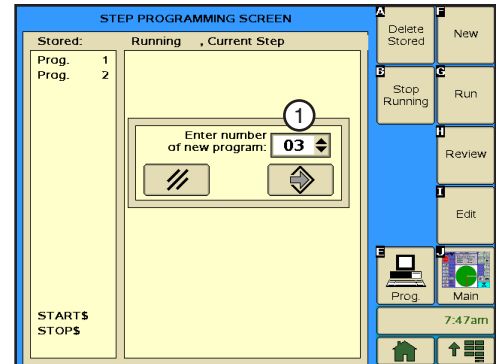

Figure 157-2 1. New Program Number Field

Step Program Examples

Repeating Irrigation Cycles

Example 3. Using Run Program Command (continued)

Program STEP 1 - Example 3 - Program One

5. Program the date and time condition for this step, do the following. Refer to Figure 158-1.
 - a) Select the **Condition** field and choose **Date/Time**.
 - b) Select the **MM/DD/YY Date** fields one at a time and choose 08, 08, 14 for August 8, 2014.
 - c) Select the **HH/MM/SS Time** fields one at a time and choose 03, 00, 00 for 3:00 AM.
6. Enter the commands to be executed at that time.
 - a) Select the **Command** field and choose **Depth**.
 - b) Push the **Depth** button, enter 1, ., 0, 0 for 1.00 inches and push the **Enter** button.
 - c) Select the next **Command** field and choose **Water**.
 - d) Push the **Water** button to set the command to Water On.
 - e) Select the next **Command** field and choose **Direction**.
 - f) Push the **Direction** button to set the command to Forward.
 - g) Select the next **Command** field and choose **Start/Stop**.
 - h) Push the **Start/Stop** button to set the command to Start.
7. Push **Next Step** to add step 2.

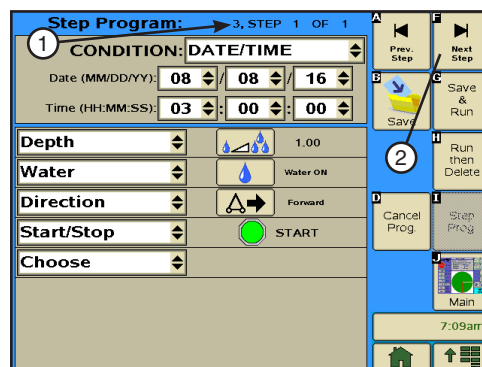

Figure 158-1 1. Step Program Identifier
2. Next Step Button

Program STEP 2 - Example 3 - Program One

8. Program the position condition for this step. Refer to Figure 158-2.
 - a) Select the **Condition** field and choose **Position**.
 - b) Select the **Degrees** field, enter 1, 8, 0 for 180 degrees and push **Enter**.
9. Enter the command to be executed at this position.
 - a) Select the **Command** field and choose **Depth**.
 - b) Push the **Depth** button, enter ., 5, 0 for 0.50 inches and push **Enter**.
10. Push **Next Step** to add step 3.

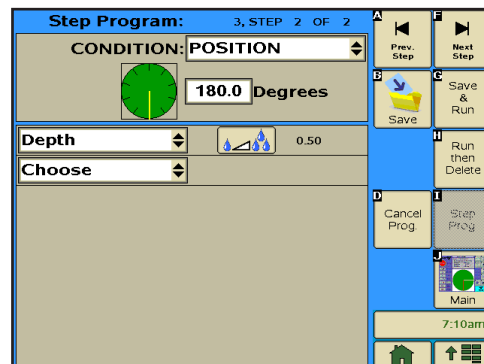

Figure 158-2

Repeating Irrigation Cycles

Example 3. Using Run Program Command (continued)

Program STEP 3 - Example 3 - Program One

11. Program the position condition for this step. Refer to Figure 159-1.
 - a) Select the **Condition** field.
 - b) Choose **Position** as the Condition for this step and use the default setting of **0.0** degrees.
12. Enter the commands to be executed at this position.
 - a) Select the **Command** field and choose **Depth**.
 - b) Push the **Depth** button, enter **1, ., 0, 0** for 1.00 inches, and push the **Enter** button.
 - c) Select the next **Command** field and choose **Run Program**.
 - d) Select the **Program Number** field and choose **2** for stored program 2.

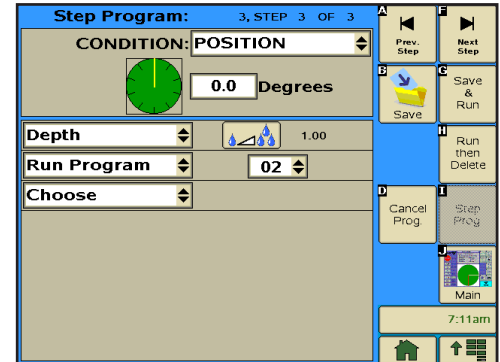

Figure 159-1

All of the steps have been created for this program. Continue with **Finish Programming**.

Finish Programming

13. Finish the program by selecting one of the following.
 - Push **Save** to save the program.
 - Push **Save & Run** to save and then run the program.
 - Push **Run Then Delete** to run the program once and then delete it.
 - Push **Cancel Prog** to cancel the program.

Step Program Examples

Repeating Irrigation Cycles

Example 3. Using Run Program Command (continued)

Create program two with two steps. Step 1 changes the water application to 0.50" at 180°, and STEP 2 stops the machine at 0°.

Program Two

Expected Conditions - Program Two:

- Machine RUNNING at 0°.

Program Machine By:

- Position: At 180°, Depth 0.50".
- Position: At 0°, STOP.

Program STEP 1 - Example 3 - Program Two

14. Program the position condition for this step. Refer to Figure 160-1.

- Select the **Condition** field and choose **Position**.
- Select the **Degrees** field, enter **1, 8, 0** for 180 degrees, and push the **Enter** button.

15. Enter the command to be executed at this position.

- Select the **Command** field and choose **Depth**.
- Push the **Depth** button, enter **., 5, 0** for 0.50 inches and push the **Enter** button.

16. Push **Next Step** to add step 2.

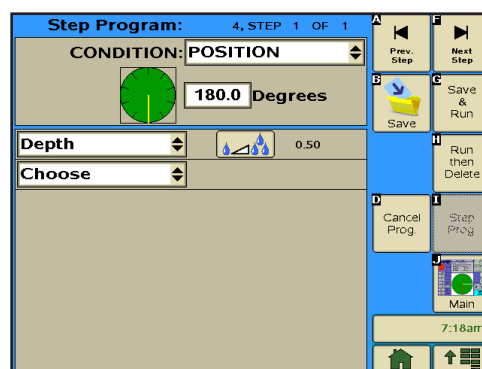

Figure 160-1

Program STEP 2 - Example 3 - Program Two

17. Program the position condition for this step. Refer to Figure 160-2.

- Select the **Condition** field, choose **Position**, and use the default setting of **0.0** degrees.
- Select the **Command** field, choose **Start/Stop**, and use the default setting of **Stop**.

All of the steps have been created for this program. Continue with **Finish Programming**.

Finish Programming

18. Finish the program by selecting one of the following.

- Push **Save** to save the program.
- Push **Save & Run** to save and then run the program.
- Push **Run Then Delete** to run the program once and then delete it.
- Push **Cancel Prog** to cancel the program.

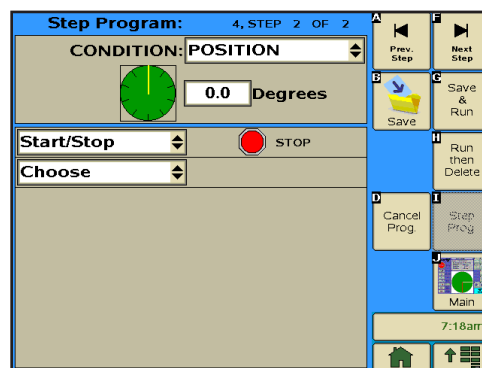

Figure 160-2

Repeating Irrigation Cycles

Example 3. Using Run Program Command (continued)

Program Operation

The programming for Example 3 is complete.

The machine starts on August 8, 2014 at 3:00 AM, changes the water application to 0.50" at 180°, changes water application to 1.00" at 0°, and then loads program #4. Program 4 changes the water application to 0.50" at 180° and stops the machine at 0°.

This sequence of events could have been programmed all in one program by adding steps 4 and 5 to the first program. However, this example was used to illustrate how one program could load another, and how it can be applied.

There could be 17 stored programs, with each one performing a different sequence of events. These could be run one right after the other by using the program command described in this example.

Step Program Examples

Scheduled Irrigation Cycles

Example 1. Time Delay with Run Program Command

This example illustrates one way to write a series of step programs, one program per irrigation cycle with time delays between each program. Execute the series of programs by running program one, program two, and program three automatically as they are called upon. Refer to Figure 162-1.

Current Conditions:

- Machine OFF at 0°.

Program Machine To:

- START on 08/08/14, at 3:00 AM, FORWARD, WATER On, Depth 1.00".
- Depth 0.75" at 180°.
- STOP machine at 0° after 3 complete irrigation cycles with a 2 day (2880 minute) delay in between each cycle.

Program One

STEP 1: At 3:00 AM on 08/08/14, WATER ON, Depth 1.00", FORWARD, START.

STEP 2: At 180°, Depth 0.75".

STEP 3: At 0°, STOP.

STEP 4: At 2880 Minutes Delay, WATER ON, Depth 1.00", FORWARD, START, Run Program #2.

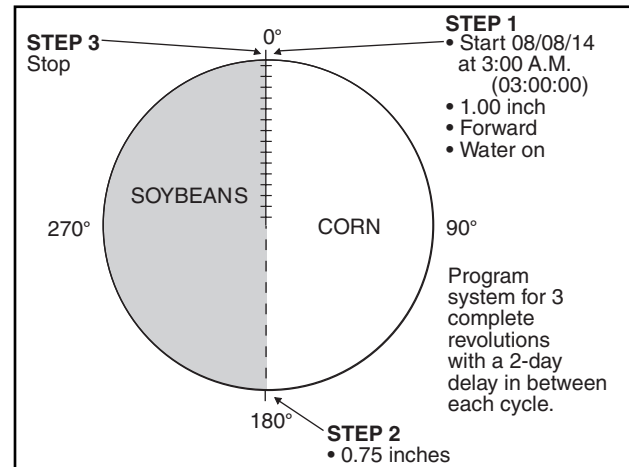

Figure 162-1

Start Programming

To write the first program of Example 1, follow these steps.

1. Push **Prog.** and **Step Prog.** to view the Step Program screen. Refer to Figure 162-2
2. Push the **New** button.
3. Select the **New Program Number** field and choose the program number.
4. Push the **Enter** button.

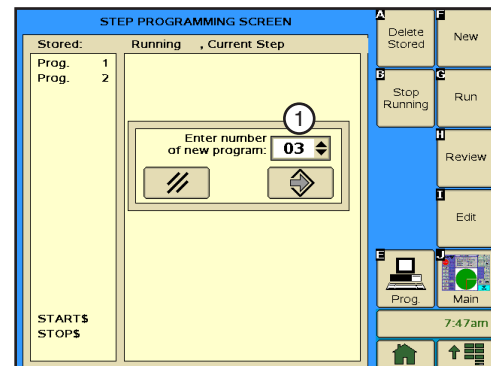

Figure 162-2 1. New Program Number Field

Scheduled Irrigation Cycles

Example 1. Time Delay with Run Program Command (continued)

Program STEP 1 - Example 1 - Program One

5. Program the date and time condition for this step, do the following. Refer to Figure 163-1.
 - a) Select the **Condition** field and choose **Date/Time**.
 - b) Select the **MM/DD/YY Date** fields one at a time and choose 08, 08, 14 for August 8, 2014.
 - c) Select the **HH/MM/SS Time** fields one at a time and choose 03, 00, 00 for 3:00 AM.
6. Enter the commands to be executed at that time.
 - a) Select the **Command** field and choose **Water**.
 - b) Push the **Water** button to set the command to Water On.
 - c) Select the next **Command** field and choose **Depth**.
 - d) Push the **Depth** button, enter 1, ., 0, 0 for 1.00 inches and push the **Enter** button.
 - e) Select the next **Command** field and choose **Direction**.
 - f) Push the **Direction** button to set the command to Forward.
 - g) Select the next **Command** field and choose **Start/Stop**.
 - h) Push the **Start/Stop** button to set the command to Start.
7. Push **Next Step** to add step 2.

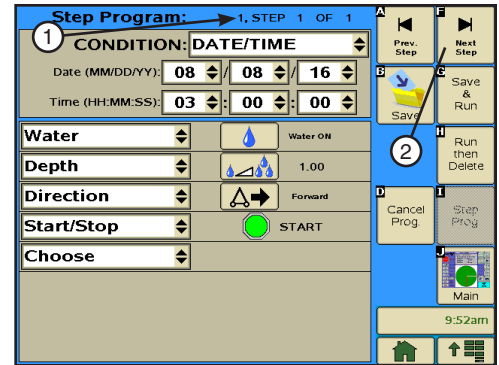

Figure 163-1 1. Step Program Identifier
2. Next Step Button

Program STEP 2 - Example 1 - Program One

8. Program the position condition for this step. Refer to Figure 163-2.
 - a) Select the **Condition** field and choose **Position**.
 - b) Select the **Degrees** field, enter 2, 7, 0 for 270 degrees and push the **Enter** button.
9. Enter the command to be executed at this position.
 - a) Select the **Command** field and choose **Depth**.
 - b) Push the **Depth** button, enter ., 7, 5 for 0.75 inches and push the **Enter** button.
10. Push **Next Step** to add step 3.

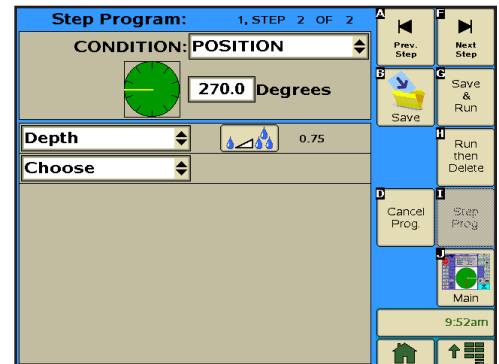

Figure 163-2

Step Program Examples

Scheduled Irrigation Cycles

Example 1. Time Delay with Run Program Command (continued)

Program STEP 3 - Example 1 - Program One

11. Program the position condition for this step. Refer to Figure 164-1.
 - a) Select the **Condition** field.
 - b) Choose **Position** as the Condition for this step and use the default setting of **0.0** degrees.
 - c) Select the next **Command** field and choose **Start/Stop**.
 - d) Push the **Start/Stop** button to set the command to Start.
12. Push **Next Step** to add step 4.

Program STEP 4 - Example 1 - Program One

13. Program the delay time condition for this step. Refer to Figure 164-2.
 - a) Select the **Condition** field and choose **Delay**.
 - b) Select the **Delay Mode** field and choose **Minutes** as the mode.
 - c) Select the **Delay Time** field, enter **2, 8, 8, 0** for 2880 minutes and push the **Enter** button.

NOTE: A delay only counts as down time when the power is ON.

14. Enter the commands to be executed after the delay.
 - a) Select the **Command** field and choose **Water**.
 - b) Push the **Water** button to set the command to Water On.
 - c) Select the next **Command** field and choose **Depth**.
 - d) Push the **Depth** button, enter **1, ., 0, 0** for 1.00 inches and push the **Enter** button.
 - e) Select the next **Command** field and choose **Direction**.
 - f) Push the **Direction** button to set the command to Forward.
 - g) Select the next **Command** field and choose **Start/Stop**.
 - h) Push the **Start/Stop** button to set the command to Start.
 - i) Select the next **Command** field and choose **Run Program**.
 - j) Select the **Program Number** field and choose **2** for stored program 2.
15. All of the steps have been created for this program, continue with Finish Programming.

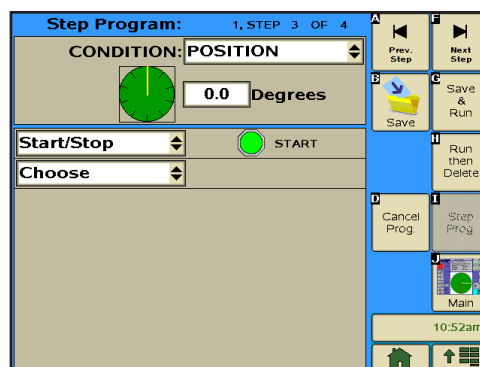

Figure 164-1



Figure 164-2

Scheduled Irrigation Cycles

Example 1. Time Delay with Run Program Command (continued)

Finish Programming

16. Finish the program by selecting one of the following.
 - Push **Save** to save the program.
 - Push **Save & Run** to save and then run the program.
 - Push **Run Then Delete** to run the program once and then delete it.
 - Push **Cancel Prog** to cancel the program.

Program Two

STEP 1: At 180°, Depth 0.75"

STEP 2: At 0°, STOP.

STEP 3: At 2880 Minutes Delay, WATER ON, Depth 1.00", FORWARD, START, run Program 3.

Start Programming

To write the second program of Example 1, follow these steps.

Program STEP 1 - Example 1 - Program Two

17. Program the position condition for this step. Refer to Figure 165-1.
 - a) Select the **Condition** field and choose **Position**.
 - b) Select the **Degrees** field, enter **1, 8, 0** for 180 degrees and push the **Enter** button.
18. Enter the command to be executed at this position.
 - a) Select the **Command** field and choose **Depth**.
 - b) Push the **Depth** button, enter **, 7, 5** for 0.75 inches, and push the **Enter** button.
19. Push **Next Step** to add step 2.

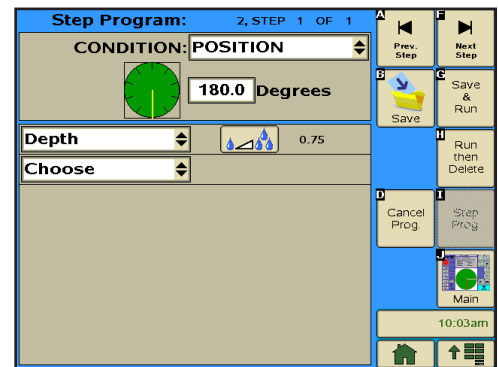

Figure 165-1

Program STEP 2 - Example 1 - Program Two

20. Program the position condition for this step. Refer to Figure 165-2.
 - a) Select the **Condition** field.
 - b) Choose **Position** as the Condition for this step and use the default setting of **0.0** degrees.
21. Enter the command to be executed at this position.
 - a) Select the **Command** field, choose **Start/Stop**, and use the default setting of **Stop**.
22. Push **Next Step** to add step 3.



Figure 165-2

Step Program Examples

Scheduled Irrigation Cycles

Example 1. Time Delay with Run Program Command (continued)

Program STEP 3 - Example 1 - Program Two

23. Program the delay time condition for this step. Refer to Figure 166-1.

- Select the **Condition** field and choose **Delay**.
- Select the **Delay Mode** field and choose **Minutes** as the mode.
- Select the **Delay Time** field, enter **2, 8, 8, 0** for 2880 minutes and push the **Enter** button.

NOTE: A delay only counts as down time when the power is ON.

24. Enter the commands to be executed after the delay.

- Select the **Command** field and choose **Water**.
- Push the **Water** button to set the command to Water On.
- Select the next **Command** field and choose **Depth**.
- Push the **Depth** button, enter **1, ., 0, 0** for 1.00 inches and push the **Enter** button.
- Select the next **Command** field and choose **Direction**.
- Push the **Direction** button to set the command to Forward.
- Select the next **Command** field and choose **Start/Stop**.
- Push the **Start/Stop** button to set the command to Start.
- Select the next **Command** field and choose **Run Program**.
- Select the **Program Number** field and choose **3** for stored program 3.

All of the steps have been created for this program. Continue with **Finish Programming**.

Finish Programming

25. Finish the program by selecting one of the following.

- Push **Save** to save the program.
- Push **Save & Run** to save and then run the program.
- Push **Run Then Delete** to run the program once and then delete it.
- Push **Cancel Prog** to cancel the program.

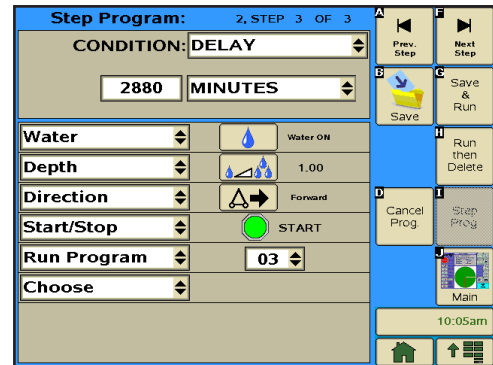

Figure 166-1

Scheduled Irrigation Cycles

Example 1. Time Delay with Run Program Command (continued)

Program Three

STEP 1: At 180°, Depth 0.75".

STEP 2: At 0°, STOP.

Start Programming

To write the third program of Example 1, follow these steps.

Program STEP 1 - Example 1 - Program Three

26. Program the position condition for this step. Refer to Figure 167-1.
 - a) Select the **Condition** field and choose **Position**.
 - b) Select the **Degrees** field, enter **1, 8, 0** for 180 degrees and push the **Enter** button.
27. Enter the command to be executed at this position.
 - a) Select the **Command** field and choose **Depth**.
 - b) Push the **Depth** button, enter **, 7, 5** for 0.75 inches, and push the **Enter** button.
28. Push **Next Step** to add step 2.

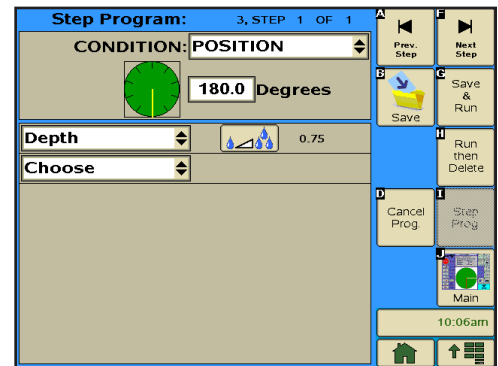

Figure 167-1

Program STEP 2 - Example 1 - Program Three

29. Program the position condition for this step. Refer to Figure 167-2.
 - a) Select the **Condition** field.
 - b) Choose **Position** as the Condition for this step and use the default setting of **0.0** degrees.
30. Enter the command to be executed at this position.
 - a) Select the **Command** field
 - b) Choose **Start/Stop** and use the default setting of **Stop**.

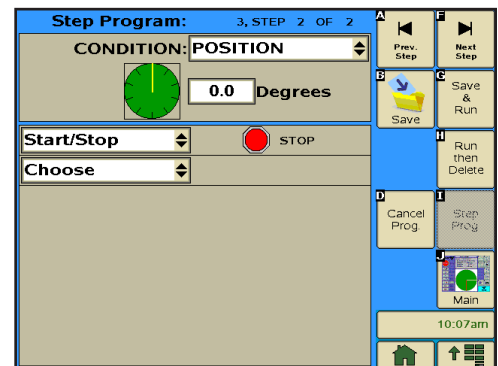

Figure 167-2

All of the steps have been created for this program. Continue with **Finish Programming**.

Finish Programming

31. Finish the program by selecting one of the following.
 - Push **Save** to save the program.
 - Push **Save & Run** to save and then run the program.
 - Push **Run Then Delete** to run the program once and then delete it.
 - Push **Cancel Prog** to cancel the program.

Step Program Examples

START\$ Program Examples

The START\$ program is used by the Auto Restart power restart feature. There must be a START\$ program and Auto Restart must be ON for power restart to operate correctly. The START\$ program preexists on the step program screen by default to start the machine and pump (if wired to do so) after a 10 minute delay. The START\$ program can be edited if the user wants to change the delay mode, adjust delay time or do something in addition to the start command.

Delayed Start - Recommended

The default START\$ program is set for a delayed start, the machine is started 10 minutes (default delay time) after regaining power when Auto Restart is ON. Use a delayed power restart to reduce the possibility of damage to an electric pump if power is lost and regained in a short period of time. The time delay for safe restart of your pump/machine may be different. When the machine starts, the DIRECTION, PERCENT, DEPTH and WATER ON or WATER OFF settings remain the same as when the machine was last shut down. That is, unless the CYCLE\$ program or Daily OPS, along with a STEP program, commands other conditions.

Immediate Start - Not Recommended

The START\$ program can be set for an immediate start, where after regaining power, the machine is started after the control panel's built-in 10 second delay. **To set up an immediate start, change the START\$ program delay mode to seconds and set the delay time to 10, for a 10 second delay.**

NOTE: Always use the delay time recommended by the manufacturer of the pumping system.

When the machine starts, the DIRECTION, PERCENT, DEPTH and WATER ON or WATER OFF remain the same as when the machine was last shut down. That is, unless the CYCLE\$ program or Daily OPS, along with a step program, commands other conditions.

CAUTION

• A DELAYED START IS RECOMMENDED TO REDUCE THE POSSIBILITY OF DAMAGE TO AN ELECTRIC PUMP IF POWER IS LOST AND REGAINED IN A SHORT PERIOD OF TIME.

Editing

To edit the START\$ program, follow these steps.

1. Push **Prog.** and **Step Prog.** to view the Step Program screen. Refer to Figure 168-1.
2. Push the **Edit** button.
3. Select the **New Program Number** field and choose **START\$**.
4. Push the **Enter** button.

Edit STEP 1

5. Select the **Delay Mode** field and choose between Seconds or Minutes. Refer to Figure 168-2.
6. Select the **Delay Time** field, enter a new delay time and push the **Enter** button.

NOTE: A delay only counts as down time when the power is ON.

7. Select the next **Command** field, choose a command and, if required, adjust its parameters.

NOTE: The START\$ program MUST contain the START command.

8. When you are done editing, finish the program by pushing **Save** to save the program.

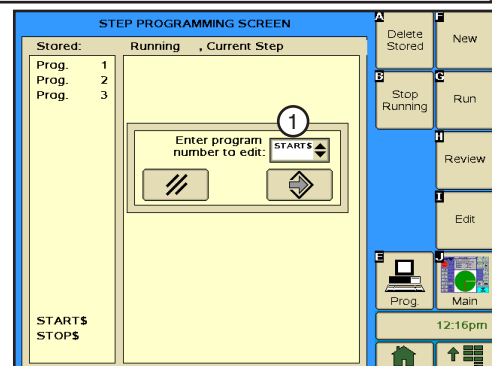

Figure 168-1 1. New Program Number Field



Figure 168-2 1. START\$ Program Identifier

STOP\$ Program Example

Immediate Stop

The STOP\$ program is used by daily OPS and the CYCLE\$ program to stop the machine. The STOP\$ program preexists on the step program screen and is pre-programmed by default to stop the machine and pump (if wired to do so) after a 0 seconds delay. The STOP\$ program can be edited if the user wants the machine to do something in addition to the stop command. The STOP command is not required to be in the STOP\$ program.

WARNING

•TO REDUCE THE POSSIBILITY OF SEVERE INJURY, DEATH AND/OR MAJOR EQUIPMENT OR PROPERTY DAMAGE, NEVER USE THE START COMMAND IN THE STOP\$ PROGRAM.

Editing

To edit the STOP\$ program for Example 1, follow these steps.

1. Push **Prog.** and **Step Prog.** to view the Step Program screen. Refer to Figure 169-1.
2. Push the **Edit** button.
3. Select the **New Program Number** field and choose **STOP\$**.
4. Push the **Enter** button.

Edit STEP 1

5. Select the **Stop Command** field and choose a different command. Refer to Figure 169-2.

NOTE: The STOP command is not required to be in the STOP\$ program.

or

6. Select the next **Command** field, choose a command and, if required, adjust its parameters.
7. When you are done editing, finish the program by pushing **Save** to save the program.

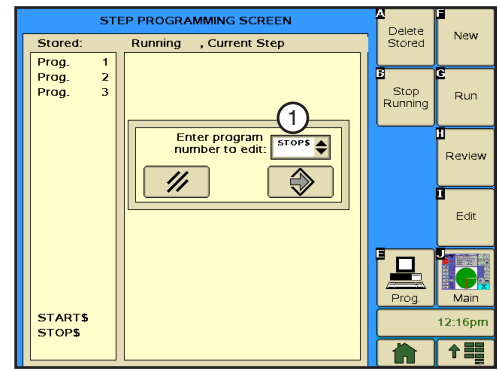

Figure 169-1 1. New Program Number Field

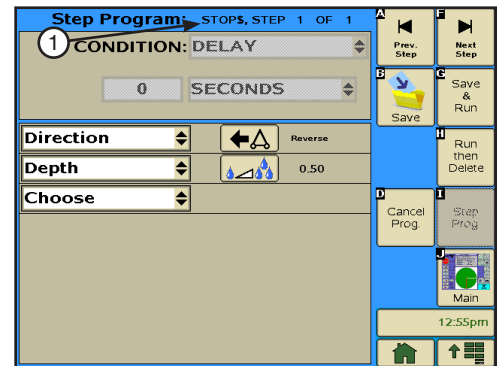

Figure 169-2 1. STOP\$ Program Identifier

Step Program Examples

CYCLE\$ Program Examples - Repeating Cycles

Example 1. Using CYCLE\$ Program

In this example, the START\$, STOP\$, and CYCLE\$ programs are used to start the machine, complete two identical irrigation cycles, and stop the machine at 0°. Refer to Figure 170-1.

Expected Conditions:

- Delayed START\$ program is written.
- STOP\$ program is written.
- Machine OFF at 0°.
- SIS position set for 0°.
- SIS is OFF.

Program Machine By:

- CYCLE\$ program.
- Position: At 0°, FORWARD, Depth 1.00".
- Position: At 180°, Depth 0.50".

NOTE

• The stop-in-slot is used as a counter by the computer to signal when a cycle has been completed. During each cycle, the machine **MUST** pass the stop-in-slot position in order to execute the CYCLE\$ program again.

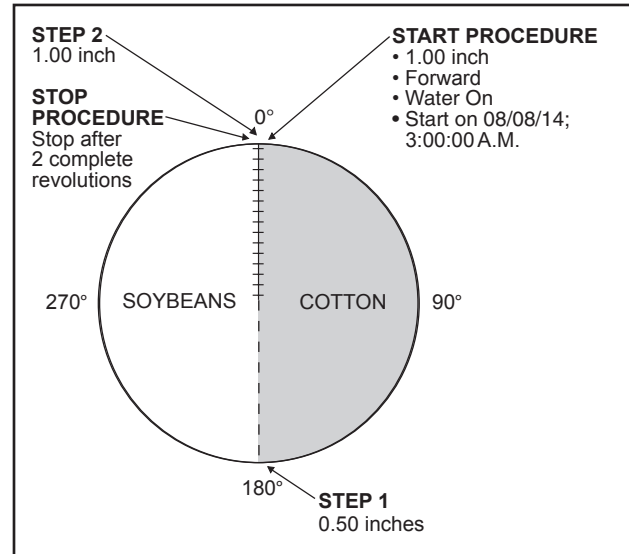

Figure 170-1

Start Programming

To write the CYCLE\$ program for Example 1, follow these steps.

1. Push **Prog.** and **Step Prog.** to view the Step Program screen. Refer to Figure 170-2.
2. Push the **Edit** button.
3. Select the **New Program Number** field and choose **CYCLES\$**.
4. Push the **Enter** button.

Program STEP 1 Example 1

5. Enter the commands to be executed. Refer to Figure 170-3.
 - a) Select the **Command** field and choose **Direction**.
 - b) Push the **Direction** button to set the command to Forward.
 - c) Select the next **Command** field and choose **Depth**.
 - d) Push the **Depth** button, enter **1, ., 0, 0** for 1.00 inches and push the **Enter** button.
6. Push **Next Step** to add step 2.

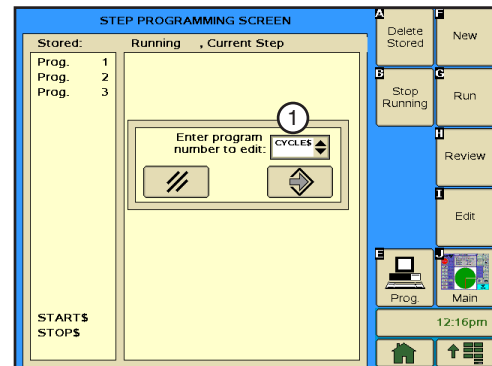

Figure 170-2 1. New Program Number Field

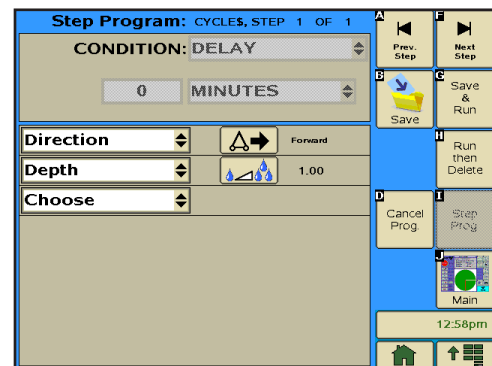

Figure 170-3

CYCLE\$ Program Examples - Repeating Cycles

Example 1. Using CYCLE\$ Program (continued)

Program STEP 2 - Example 1

7. Program the position condition for this step. Refer to Figure 171-1.
 - a) Select the **Condition** field.
 - b) Choose **Position**.
 - c) Select the **Degrees** field, enter **1, 8, 0** for 180 degrees and push the **Enter** button.
8. Enter the command to be executed at this position.
 - a) Select the **Command** field and choose **Depth**.
 - b) Push the **Depth** button, enter **., 5, 0** for 0.50 inches and push the **Enter** button.

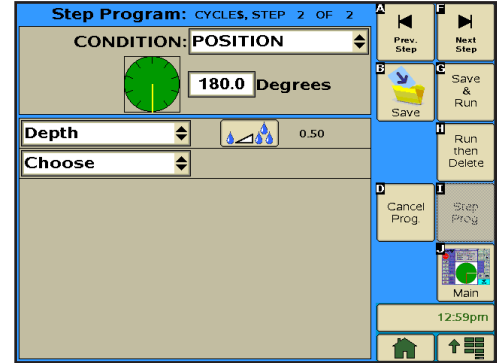

Figure 171-1

All of the steps have been created for this program. Continue with **Finish Programming**.

Finish Programming

9. Finish the program by selecting one of the following.
 - Push **Save** to save the program.
 - Push **Save & Run** to save and then run the program.
 - Push **Run Then Delete** to run the program once and then delete it.
 - Push **Cancel Prog** to cancel the program.

Executing CYCLE\$

The CYCLE\$ program can be executed immediately (Option 1) from the Prog/Cycles/SIS Bypass screen, or the CYCLE\$ program can be executed by time (Option 2) through a step program.

Option 1 - Execute CYCLE\$ Immediately

To immediately execute the CYCLE\$ program, follow these steps.

1. Push **Prog** and **Cycles** to view the Cycles screen. Refer to Figure 171-2.
2. Push **SIS Bypass**.
3. If necessary, push the Stop-In-Slot button to turn **SIS OFF**.
4. Select the **Number of Times to Bypass SIS** field.
5. Enter the number of times to bypass SIS and push the **Enter** button.
6. Push the **Run** button.

NOTE: The machine starts immediately after Pushing ENTER, and executes two complete cycles before stopping.

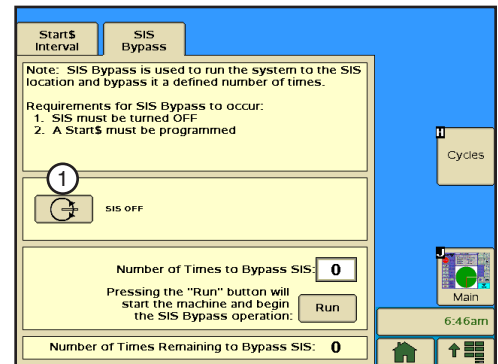

Figure 171-2 1. Stop-In-Slot Button

Step Program Examples

CYCLE\$ Program Examples - Repeating Cycles

Example 1. Using CYCLE\$ Program (continued)

Option 2 - Execute CYCLE\$ By Time

To execute the CYCLE\$ program due to a condition, follow these steps.

1. Push **Prog** and **Step Program** to view the Step Program screen. Refer to Figure 172-1.
2. Push the **New** button.
3. Select the **New Program Number** field and choose the Program Number.
4. Push the **Enter** button.
5. Program the date and time condition for this step, do the following.
 - a) Select the **Condition** field
 - b) Choose **Date/Time**.
 - c) Select the **MM/DD/YY Date** fields one at a time and choose 08, 08, 14 for August 8, 2014.
 - d) Select the **HH/MM/SS Time** fields one at a time and choose 03, 00, 00 for 3:00 AM.
6. Enter the command to be executed at that time.
 - a) Select the **Command** field and choose **Set Cycles**.
 - b) Select the **Set Cycles** field, enter the number of cycles to run, and push the **Enter** button.

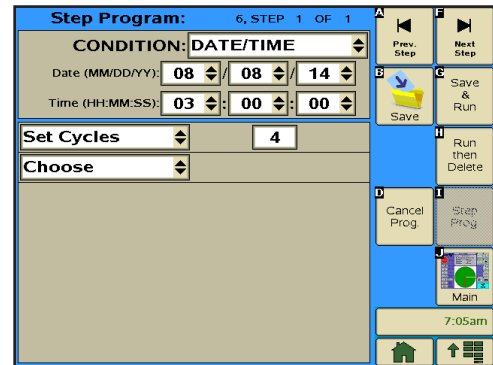

Figure 172-1

All of the steps have been created for this program. Continue with **Finish Programming**.

Finish Programming

7. Finish the program by selecting one of the following.
 - Push **Save** to save the program.
 - Push **Save & Run** to save and then run the program.
 - Push **Run Then Delete** to run the program once and then delete it.
 - Push **Cancel Prog** to cancel the program.

Daily OPS Examples - Scheduled Irrigation Hours

Example 1. Seven Days a Week

This example requires that DAILY OPS be active every day of the week. With this example, when the machine is running the machine DIRECTION, PERCENT/DEPTH and WATER ON or WATER OFF settings remain the same as when the machine was last shut down.

Expected Conditions:

- Delayed START\$ program is written.
- Desired STOP\$ program is written.
- Machine is stopped at SIS position.

Program Machine To:

- STOP at 10:00 AM and START at 6:00 PM seven days a week.

The machine operates in the following way depending on mode.

Daily Operations Mode	
Sun	Run Stopped - Run NOT Allowed Run
Mon	Run Stopped - Run NOT Allowed Run
Tue	Run Stopped - Run NOT Allowed Run
Wed	Run Stopped - Run NOT Allowed Run
Thu	Run Stopped - Run NOT Allowed Run
Fri	Run Stopped - Run NOT Allowed Run
Sat	Run Stopped - Run NOT Allowed Run
HOURS	1 2 3 4 5 6 7 8 9 10 11 12 13 14 15 16 17 18 19 20 21 22 23 24

Load Management Mode	
Sun	Run Stopped - Run IS Allowed Run
Mon	Run Stopped - Run IS Allowed Run
Tue	Run Stopped - Run IS Allowed Run
Wed	Run Stopped - Run IS Allowed Run
Thu	Run Stopped - Run IS Allowed Run
Fri	Run Stopped - Run IS Allowed Run
Sat	Run Stopped - Run IS Allowed Run
HOURS	1 2 3 4 5 6 7 8 9 10 11 12 13 14 15 16 17 18 19 20 21 22 23 24

To program Example 1, follow these steps.

1. Push **Prog** and **Daily OPS** to view the Daily OPS Program screen. Refer to Figure 173-1.
2. Check the **Daily OPS** check box to enable Daily OPS.
3. Select the **Mode** field and choose the **Daily Operations** or the **Load Management** mode.

If Load Management is chosen, check the **Restart** check box to allow the machine to restart when the power comes back on.

4. Select the **HH/MM/SS Start Time** fields one at a time, enter **18, 00, 00** for 6:00 PM, and push the **Enter** button.
5. Select the **HH/MM/SS Stop Time** fields one at a time, enter **10, 00, 00** for 10:00 AM, and push the **Enter** button.
6. Select the **Days to Run**, check the corresponding check box for every day of the week. These are the days of the week that Daily OPS will be active.

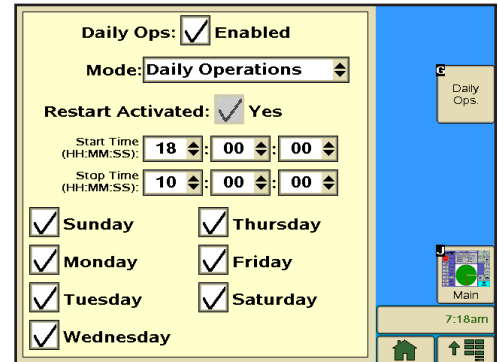

Figure 173-1

Step Program Examples

Daily OPS Examples - Scheduled Irrigation Hours

Example 2. Selected Days with Stop before Start

This example requires that DAILY OPS option be active only on Monday through Thursday. With this example, when the machine is running the machine DIRECTION, PERCENT/DEPTH and WATER ON or WATER OFF settings remain the same as when the machine was last shut down.

Expected Conditions:

- Delayed START\$ program is written.
- Desired STOP\$ program is written.
- Machine is stopped at SIS position.

Program Machine To:

- STOP at 9:00 AM and START at 7:00 PM on Monday through Thursday.

The machine operates in the following way depending on mode.

Daily Operations Mode	
Sun	Stopped - Run NOT Allowed
Mon	Stopped - Run NOT Allowed Run ▶
Tue	▶ Run Stopped - Run NOT Allowed Run ▶
Wed	▶ Run Stopped - Run NOT Allowed Run ▶
Thu	▶ Run Stopped - Run NOT Allowed Run ▶
Fri	▶ Run Stopped - Run NOT Allowed Run ▶
Sat	▶ Run Stopped - Run NOT Allowed Run ▶
HOURS	1 2 3 4 5 6 7 8 9 10 11 12 13 14 15 16 17 18 19 20 21 22 23 24

Load Management Mode	
Sun	Run Run Run
Mon	▶ Run Stopped - Run IS Allowed Run ▶
Tue	▶ Run Stopped - Run IS Allowed Run ▶
Wed	▶ Run Stopped - Run IS Allowed Run ▶
Thu	▶ Run Stopped - Run IS Allowed Run ▶
Fri	▶ Run Stopped - Run IS Allowed Run ▶
Sat	▶ Run Run Run
HOURS	1 2 3 4 5 6 7 8 9 10 11 12 13 14 15 16 17 18 19 20 21 22 23 24

To program Example 2, follow these steps.

1. Push **Prog** and **Daily OPS** to view the Daily OPS Program screen. Refer to Figure 174-1.
2. Check the **Daily OPS** check box for Daily OPS On.
3. Select the **Mode** field and choose the **Daily Operations** or the **Load Management** mode.

If Load Management is chosen, check the **Restart** check box to allow the machine to restart when the power comes back on.

4. Select the **HH/MM/SS Start Time** fields one at a time, enter **19, 00, 00** for 7:00 PM, and push the **Enter** button.
5. Select the **HH/MM/SS Stop Time** fields one at a time, enter **09, 00, 00** for 9:00 AM, and push the **Enter** button.
6. Select the **Days to Run**, check the corresponding check box for Monday, Tuesday, Wednesday and Thursday. These are the days of the week that Daily OPS will be active.

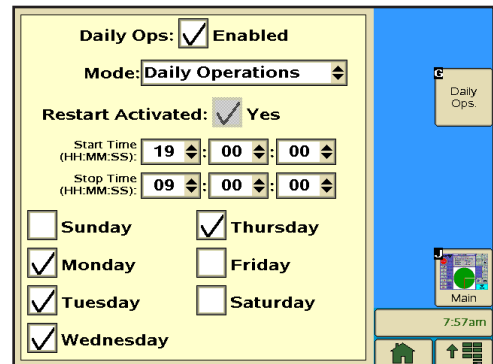

Figure 174-1

Daily OPS Examples - Scheduled Irrigation Hours

Example 3. Selected Days with Start before Stop

This example requires that DAILY OPS be active only on Monday through Thursday. With this example, when the machine is running, the machine DIRECTION, PERCENT/DEPTH and WATER ON or WATER OFF remains the same as when the machine was last shut down.

Expected Conditions:

- Delayed START\$ program is written.
- Desired STOP\$ program is written.
- Machine is stopped at SIS position.

Program Machine To:

- START at 1:00 AM and STOP at 9:00 AM on Monday through Thursday.

The machine operates in the following way, depending on mode.

Daily Operations Mode	
Sun	Stopped - Run NOT Allowed
Mon	Run Stopped - Run NOT Allowed
Tue	Run Stopped - Run NOT Allowed
Wed	Run Stopped - Run NOT Allowed
Thu	Run Stopped - Run NOT Allowed
Fri	Stopped - Run NOT Allowed
Sat	Stopped - Run NOT Allowed
HOURS	1 2 3 4 5 6 7 8 9 10 11 12 13 14 15 16 17 18 19 20 21 22 23 24

Load Management Mode	
Sun	Stopped - Run IS Allowed
Mon	Run Stopped - Run IS Allowed
Tue	Run Stopped - Run IS Allowed
Wed	Run Stopped - Run IS Allowed
Thu	Run Stopped - Run IS Allowed
Fri	Stopped - Run IS Allowed
Sat	Stopped - Run IS Allowed
HOURS	1 2 3 4 5 6 7 8 9 10 11 12 13 14 15 16 17 18 19 20 21 22 23 24

To program Example 3, follow these steps.

1. Push **Prog** and **Daily OPS** to view the Daily OPS Program screen. Refer to Figure 175-1.
2. Check the **Daily OPS** check box for Daily OPS On.
3. Select the **Mode** field and choose the **Daily Operations** or the **Load Management** mode.

If Load Management is chosen, check the **Restart** check box to allow the machine to restart when the power comes back on.

4. Select the **HH/MM/SS Start Time** fields one at a time, enter **01, 00, 00** for 1:00 AM, and push the **Enter** button.
5. Select the **HH/MM/SS Stop Time** fields one at a time, enter **09, 00, 00** for 9:00 AM, and push the **Enter** button.
6. Select the **Days to Run**, check the corresponding check box for Monday, Tuesday, Wednesday and Thursday. These are the days of the week that Daily OPS will be active.

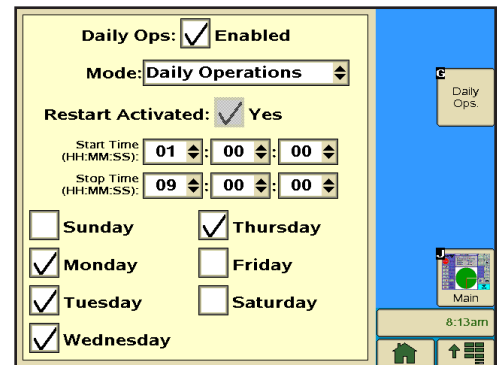

Figure 175-1

Step Program Examples

Daily OPS Examples - Scheduled Irrigation Cycles

Example 4. Daily OPS Cycle - Interval in Days

Daily OPS cycle allows the operator to run complete irrigation cycles at specified intervals in days. For example, the operator may want to irrigate every 3 days or 5 days. This feature uses the START\$, STOP\$, and CYCLE\$ programs. Refer to Figure 176-1.

Expected Conditions:

- Delayed START\$ program is written.
- STOP\$ program is written.
- Machine off at 0°.
- Stop-In-Slot is set to 0°.
- Stop-In-Slot is OFF.

Program Machine To:

- Start on 08/08/14, at 10:00 AM
- Water On.
- FORWARD, Depth 1.00".
- Depth 0.50" at 180°.
- Execute one complete revolution every three days.

NOTE

- The stop-in-slot is used as a counter by the computer to signal when a cycle has been completed. During each cycle, the machine **MUST** pass the stop-in-slot position in order to execute the CYCLE\$ program again.

Setup Cycle Interval

To set up the Cycle Interval for Example 4, do the following.

1. Push **Prog** and **Cycles** to view the Cycles screen. Refer to Figure 176-1.
2. Push **START\$ Interval**.
3. If necessary, push the **Stop In Slot** button to turn **SIS OFF**.
4. Check the **Start Interval** check box to enable START\$ Interval.
5. Select the **Start Interval Days** field and enter **3** to repeat the cycle every three days.
6. Push the **Enter** button.
7. Select the **HH/MM/SS Start Time** fields one at a time, enter **10, 00, 00** for 10:00 AM.

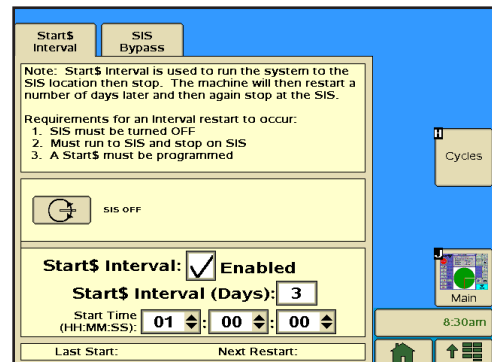

Figure 176-1

Daily OPS Examples - Scheduled Irrigation Cycles

Example 4. Daily OPS Cycle - Interval in Days (continued)

Write CYCLE\$ Program

To write the CYCLE\$ program for Example 4, follow these steps.

Program STEP 1 - Example 4

1. Push **Prog.** and **Step Prog.** to view the Step Program screen. Refer to Figure 177-1.
2. Push the **New** button.
3. Select the **New Program Number** field and choose the **CYCLE\$** Program.
4. Push the **Enter** button.

Program STEP 1 Example 4

5. Enter the commands to be executed. Refer to Figure 177-2.
 - a) Select the **Command** field and choose **Direction**.
 - b) Push the **Direction** button to set the command to Forward.
 - c) Select the next **Command** field and choose **Depth**.
 - d) Push the **Depth** button, enter **1, ., 0, 0** for 1.00 inches and push the **Enter** button.
6. Push **Next Step** to add step 2.

Program STEP 2 - Example 4

7. Program the position condition for this step. Refer to Figure 177-3.
 - a) Select the **Condition** field and choose **Position**.
 - b) Select the **Degrees** field, enter **1, 8, 0** for 180 degrees and push the **Enter** button.
8. Enter the command to be executed at this position.
 - a) Select the **Command** field and choose **Depth**.
 - b) Push the **Depth** button, enter **., 5, 0** for 0.50 inches and push the **Enter** button.

All of the steps have been created for this program. Continue with **Finish Programming**.

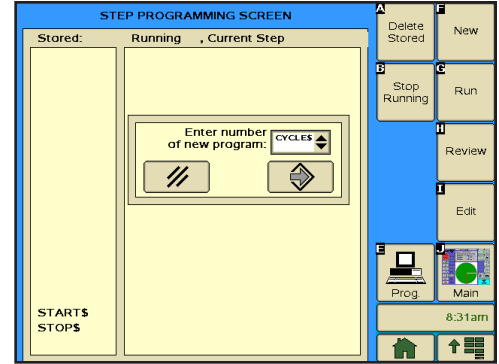

Figure 177-1

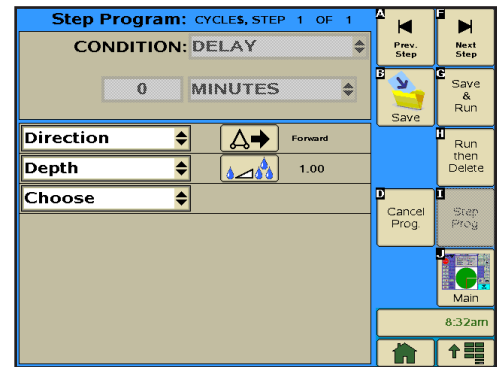

Figure 177-2

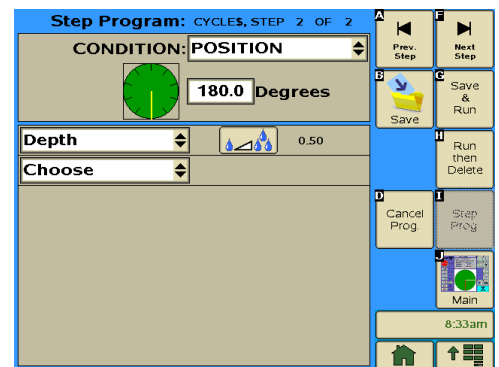

Figure 177-3

Step Program Examples

Daily OPS Examples - Scheduled Irrigation Cycles

Example 4. Daily OPS Cycle - Interval in Days (continued)

Finish Programming

9. Finish the program by selecting one of the following.
 - Push **Save** to save the program.
 - Push **Save & Run** to save and then run the program.
 - Push **Run Then Delete** to run the program once and then delete it.
 - Push **Cancel Prog** to cancel the program.

Design Forms

This appendix provides blank forms for your use when planning your Step and Sector programs. They provide you with the ability to describe the conditions, commands, and options you want included in the programs.

Make as many copies of these forms as you need. You may want to keep the completed design forms on file for future reference.

Step Programming Design Form

Use the circular drawing to map out the field, and the table to describe the conditions, commands, and options required in each step of the program. You can have up to 17 Step programs for each machine, with up to 9 steps in each.

NOTE: The commands in each step will be executed in the order in which they are entered.

Sector Programming Design Form

Use the circular drawing to map out the field, and the table to describe the commands and options required in each sector of the field. You can have up to 20 Sector programs for each machine, with up to 9 steps in each.

NOTE: The commands for each sector will be executed in the order in which they are entered.

Programming Design Forms

STEP Program Number _____
 Field ID _____

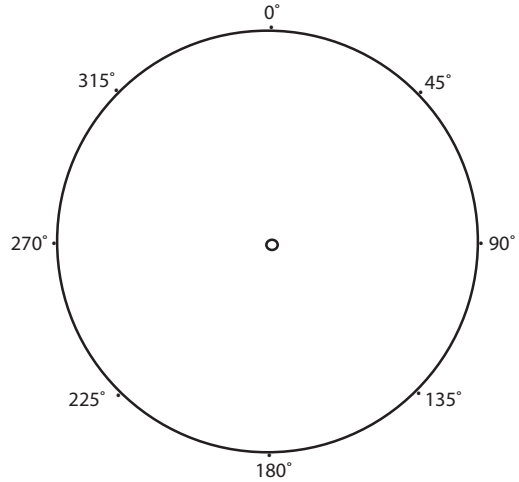

CONDITIONS	STEP NUMBER								
	1	2	3	4	5	6	7	8	9
DATE/TIME									
DAY/TIME									
POSITION									
PRESSURE									
DELAY									
DIRECTION FOR/REV									
ANALOG									
MODULE									
PULSE RAT									
COUNT									
WIND									
TEMPERATURE									
RAIN									
COMMANDS									
DIRECTION FOR/REV									
WATER ON/OFF									
DEPTH									
PERCENTAGE									
AUX 1 ON / OFF									
AUX 2 ON / OFF									
RUN PROGRAM									
STOP-IN-SLOT ON/OFF									
MODULE ON/OFF									
ARAS									
AUTORESTART									
SET CYCLES									
START\$/STOP\$									
% OF PERCENTAGE TIMER									
% OF DEPTH									
TRIGGER LOGGING EVENT									
CRUISE CONTROL									
VRI ON/OFF									
ENDGUN									
WIDE BOUNDARY 1, 2, 3									
START/STOP									

Programming Design Forms

SECTOR Programs
Field ID _____

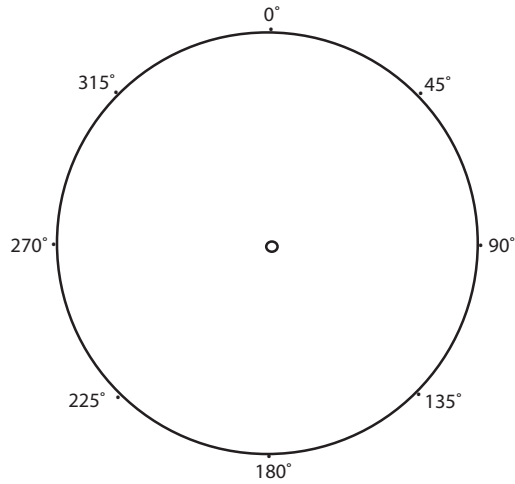

Sector Program #	Start Angle	End Angle	Direction	Commands
1				
2				
3				
4				
5				
6				
7				
8				
9				
10				
11				
12				
13				
14				
15				
16				
17				
18				
19				
20				

Programming Design Forms
