



**Valley ClassicPlus  
Control Panel**

**Owner's Manual**

**0998940\_C**

# Valley ClassicPlus Control Panel

---

# Valley ClassicPlus Control Panel

## Table of Contents

<b>EC Declaration of Conformity</b> .....	5
<b>Electrical Safety Statement</b> .....	6
<b>About This Manual</b> .....	6
<b>Ancillary Equipment Warranty</b> .....	6
<b>Safety</b> .....	7
Recognize Safety Information .....	7
Safety Messages .....	7
Information Messages .....	7
Use of Personal Protective Equipment.....	8
Conductive Materials and Equipment.....	8
Fall Protection.....	8
Minimum Working Clearance .....	9
Qualified Person .....	9
Irrigation Equipment near Airports and Crop Dusting Aircraft .....	9
Overhead Power Lines .....	10
Minimal Lockout / Tagout Procedure .....	11
Sequence of Lockout .....	11
Restoring Equipment to Service .....	11
Operate Safely.....	12
Safety Decals .....	16
<b>Overview</b> .....	19
Controls and Components.....	19
Main Disconnect Switch.....	20
3 Second Auto Restart.....	20
Start-Stop Switch.....	20
Forward/Reverse Switch .....	20
Wet/Dry Switch .....	21
SIS On/Off .....	21
Indicator Lights .....	21
Percentage Timer.....	22
Volt Meter.....	22
Option Switches.....	23
Engine Run/Start Switch.....	23
Auto Reverse/Auto Stop Switch .....	23
<b>Operation</b> .....	25
Starting The System Wet (With Water).....	25
Starting The System Dry (Without Water) .....	26
Stopping The Machine .....	27
Emergency Stopping .....	27
Stopping Under Normal Conditions .....	27
Indicator Lights .....	28
Panel and Towers Lights.....	28
End Tower Light .....	28
Forward and Reverse Lights .....	28
Safety Override Button .....	29
Percent Timer .....	30
Testing the Solid State Percent Timer .....	31
Percent Timer Setting Calculations .....	32
Percent Timer Setting Calculation Worksheet .....	34
<b>Appendix</b> .....	36
Tire Pressure.....	36
Replacing Tires.....	36

# Valley ClassicPlus Control Panel

---

## Table of Contents

# EC Declaration of Conformity



We: **Valmont Industries, Inc.**  
**28800 Ida Street**  
**Valley, NE 68064**  
**+1 402.359.6312**  
**+1 402.359.6143 (Facsimile)**

Serial Number:

Purchase Order:

declare under our sole responsibility that the product,

## **Crop Irrigation System**

to which this documentation relates, is in conformity with the following documents:

**Machinery Directive 2006/42/EC**  
**Low Voltage Directive 2014/35/EU**  
**Electromagnetic Compatibility Directive 2014/30/EU**

The above-referenced equipment is in conformity with all safety-related clauses (Not all clauses reflecting commercial preference are met) of the following documents:

**EN 60204-1:2006 Safety of Machinery – Electrical Equipment of Machines**  
**EN 12100:2010 Safety of Machinery**  
**EN 909:1998+A1 Irrigation Machines**

Statement regarding **Pressure Equipment Directive 97/23/EC:**

The Crop Irrigation System is excluded from the scope of the Pressure Equipment Directive, by the language of Article 1, Sections 3.2, 3.6 & 3.10. This equipment is classified less than Category 1.

Statement regarding **RoHS Directive 2011/65/EC:**

The Crop Irrigation System is excluded from the scope of the RoHS Directive, by the language of Article 2, Section 4(e), being a "Large Scale Fixed Installation."

Person Authorized to Compile the Technical File in Europe:  
Relevant information will be transmitted via e-mail  
in response to a reasoned request by national authorities

Ruediger Claas  
Valmont Industries Inc.  
Nordring 4  
45894 Gelsenkirchen  
Germany  
+49(151)16716790

Ron Pollak  
Senior Electrical Engineer  
Valmont Industries, Inc.

Date of Issue: December 17, 2018  
Place of Issue: Valley, NE 68064

# Valley ClassicPlus Control Panel

---

## Electrical Safety Statement

### Installation Of The Valley Electric Irrigation Machine

Valmont Industries Inc. does not install a differential (ground fault) circuit breaker in the control panel of the Valley electric irrigation machine because the standards of protection vary according to country of destination. The distributor must provide and install a differential (ground fault) circuit breaker that meets the standards of the country where the Valley irrigation machine is installed.

In the European Union, differential circuit breaker protection is fixed at a maximum of 24 volts.

Good grounding of the Valley irrigation machine is required.

- If resistance to ground is lower than 80 ohms, a differential (ground fault) circuit breaker of 300 mA will meet requirements.
- If resistance to ground is between 80 and 800 ohms, a differential (ground fault) circuit breaker of 30 mA will meet requirements.

The power supply installation and inspection of equipment protection components or machines are the responsibility of the installer. Valmont Industries Inc. is not responsible for the failure of equipment protection components or machines not of their manufacture.

Valley pivot irrigation machines receiving power from a generator must have a cable connected from the irrigation machine structure to a ground rod and another cable from the irrigation machine structure to the ground terminal on generator in order for the differential (ground fault) circuit breaker to work.

- The resistance between the irrigation machine and the generator must be substantially below 80 ohms.

## About This Manual

This manual covers safety and operation of the Valley ClassicPlus Control Panel. Additional sections related to safety, pivot hardware, maintenance, towing, troubleshooting, winterization and electrical standards are covered in the appropriate Valley Pivot or Linear Owners Manual (English).

You, as the owner/operator, should familiarize yourself with the capabilities of the system in order to obtain optimum system performance. It should be remembered that the sprinkler will perform according to your knowledge of the equipment, soil and water relationships and equipment application concepts.

Specifications, descriptions and illustrative material contained herein were as accurate as known at the time this publication was approved for printing.

Valmont Industries Inc., reserves the right to change specification or design without incurring obligation. Specifications are applicable to machines sold in the United States and may vary outside the United States.

## Ancillary Equipment Warranty

The owner is responsible for warranty registration of all ancillary equipment such as engines, pumps, and generators with its respective manufacturer.

# Valley ClassicPlus Control Panel

## Safety

### Recognize Safety Information

This irrigation equipment can be powered by high voltage, which can be extremely dangerous if used improperly. For maximum safety and optimum performance of the machine, all owner/operators and maintenance personnel must read and understand the owner/operator manual(s), all safety messages in this manual and safety signs/decals on the machine before operating this equipment.

Anyone assembling, operating, servicing or maintaining this machine must read and understand all operation, maintenance, troubleshooting, testing, installation, assembly instructions and all safety messages in this manual before operating the machine or beginning any maintenance, troubleshooting, testing, installation or assembly of components.

These instructions alert you to certain things you should do carefully; if you don't, you could hurt yourself or others, hurt the next person who operates the equipment, or damage the equipment.

### Safety Messages

Safety messages in this manual are preceded by the hazard symbol and one of three words: DANGER, WARNING or CAUTION. These messages alert you to potential hazards that could hurt you or others and or cause property damage.



This HAZARD SYMBOL is used to alert you to information about unsafe actions or situations, and may be followed by the word DANGER, WARNING or CAUTION.

### **DANGER**

The HAZARD SYMBOL used with the word DANGER describes immediate hazards that can result in severe personal injury or death.

### **WARNING**

The HAZARD SYMBOL used with the word WARNING describes unsafe actions or situations that can result in severe injury, death and/or major equipment or property damage.

### **CAUTION**

The HAZARD SYMBOL used with the word CAUTION describes unsafe actions or situations that can result in injury, and/or minor equipment or property damage.

### Information Messages

Important information messages in this manual are preceded by the word NOTE.

### **NOTE**

The word NOTE is used to alert you to information that describes procedures or tips to help you install, operate or maintain your equipment properly.

# Valley ClassicPlus Control Panel

---

## Safety

### Use of Personal Protective Equipment

- People working in areas where there are potential electrical hazards must use, personal protective equipment that is appropriate for the specific parts of the body to be protected and for the work to be performed. Refer to U.S. Occupational Safety & Health Administration (OSHA) Regulations (Standards - 29 CFR) Safeguards for personnel protection. - 1910.335, or applicable national, state or local regulations, for additional information.
- Personal protective equipment must be maintained in a safe, reliable condition and periodically inspected or tested.
- Protective shields, protective barriers, or insulating materials must be used to protect each person from shock, burns, or other electrically-related injuries while that person is working near exposed energized parts which might be accidentally contacted or where dangerous electric heating or arcing might occur. When normally enclosed live parts are exposed for maintenance or repair, they must be guarded to protect unqualified persons from contact with the live parts.
- Safety signs and tags. Safety signs, safety symbols, or accident prevention tags must be used where necessary to warn people about electrical hazards which may endanger them.

### Conductive Materials and Equipment

Materials and equipment that can conduct electricity must be handled in a way that will prevent them from contacting energized power lines, exposed conductors or circuit parts.

- When handling long conductive objects (such as but not limited to truss rods, pipes, angles and ladders) in areas with energized power lines, exposed conductors or circuit parts, work practices (such as the use of insulation, guarding, and material handling techniques) must be used to minimize the hazard.
- Portable ladders must have non-conductive side rails.
- Do not wear conductive articles of jewelry and clothing (such as but not limited to watch bands, bracelets, rings, key chains, necklaces, metalized aprons, cloth with conductive thread, or metal headgear) that could come in contact with energized power lines, exposed conductors or circuit parts.

### Fall Protection

Identify potential fall hazards and determine if fall protection equipment is appropriate for the task, before beginning the work. Pay attention to hazards associated with routine and non-routine tasks. Inspect fall protection equipment (harnesses, lanyards) and devices (guardrails, tie-off points) before each use. Use fall protection equipment if required for the job. Be sure the fall protection equipment is right for the task, fits properly, and is in good condition. Refer to U.S. Occupational Safety & Health Administration (OSHA) Regulations Standards - 29 CFR 1926.500, 1926.501 and 1926.502, or applicable national, state or local regulations for more information.

- When using scaffolds, make sure there is proper access, full planking, stable footing, and guard railing.
- When using a boom lift, keep feet firmly on the platform of a boom lift, use fall protection equipment tied-off at all times to the guardrail or tie-off point.
- When using a ladder, make sure the ladder is non-conductive and the correct size for the task. Read the ladder user instructions and be sure the ladder is in good condition. Make sure ladder is set on stable footing and at the correct angle.



# Valley ClassicPlus Control Panel

## Safety

### Minimum Working Clearance

To reduce the risk of injury, all persons require adequate working clearance around the electrical panel or other electrical equipment. The table below identifies the minimum working clearance needed. Refer to U.S. Occupational Safety & Health Administration (OSHA) Regulations (Standards - 29 CFR) Safeguards for personnel protection. -1910.303(g)(1)(i), or any other applicable national, state or local regulations, for additional information.

MINIMUM WORKING CLEARANCE 0-600 VOLTS				
WIDTH OF WORKING CLEARANCE AREA	HEIGHT OF WORKING CLEARANCE AREA	★MINIMUM WORKING CLEARANCE IN FRONT OF ELECTRICAL PANEL/EQUIPMENT		
		EXPOSED LIVE PARTS ON ONE SIDE OF WORK SPACE AND NO LIVE GROUNDED PARTS ON THE OTHER SIDE.	EXPOSED LIVE PARTS ON ONE SIDE OF WORK SPACE AND LIVE GROUNDED PARTS ON THE OTHER SIDE.	EXPOSED LIVE PARTS ON ONE SIDE OF WORK SPACE AND EXPOSED LIVE PARTS ON THE OTHER SIDE.
30 in (760 mm) MINIMUM OR WIDTH OF ENCLOSURE, WHICH EVER IS GREATER	78 in (1980 mm) MINIMUM OR HEIGHT OF ENCLOSURE, WHICH EVER IS GREATER	36 in (915 mm) MINIMUM	42 in (1065 mm) MINIMUM	48 in (1220 mm) MINIMUM

★Concrete, brick or tile walls shall be considered as grounded.

### Qualified Person

A Qualified Person is one who, by possession of a recognized degree, certificate, or professional standing, or who by extensive knowledge, training, and experience, has successfully demonstrated his/her ability to solve or resolve problems related to the subject matter, the work, or the project.

Only qualified persons may work on electric circuit parts or equipment that have not been de-energized.

Refer to U.S. Occupational Safety & Health Administration (OSHA) Regulations Standards - 29 CFR 1926.32(m) and 1910.333, or applicable national, state or local regulations for additional information.

### Irrigation Equipment near Airports and Crop Dusting Aircraft

- If any part of the irrigation machine comes within 3200 ft (975 m) of an airport runway, especially the approach (ends) of the runway, additional warning markers may be required. In the United States, CFR Title 14, Chapter I, Subchapter E, Part 77 – Safe, Efficient Use, and Preservation of the Navigable Airspace describes when marking is needed.

This document is available at: [www.ecfr.gov](http://www.ecfr.gov)

- Marking requirements vary depending on the location of the irrigation equipment relative to the runway, the type of airport (Civil, Military, or Heliport) and other factors. Contact the local airport authority for guidance and specific recommendations. In the United States, guidelines for marking structures near airports are published by the Federal Aviation Administration in Advisory Circular AC 70/7460-1L – Obstruction Marking and Lighting.

Available here: [www.faa.gov/regulations\\_policies/advisory\\_circulars](http://www.faa.gov/regulations_policies/advisory_circulars)

- For irrigation machines near private or unregulated airfields, including farm-based airstrips, Valley strongly recommends complying with the same standards and requirements as Civil airports as shown in Part 77.
- Regulations vary by country, contact your local aviation authority for guidance.

Overhang cables, including overhang back cables are a particular danger. In locations where low-flying aircraft are likely, such as within 1,500 ft (457 m) of an end of an airport runway, or where crop dusting aircraft are common, Valley recommends adding obstruction markers to overhang cables to improve their visibility.

For large overhangs (36 ft / 10.97 m Heavy Duty and longer), five 12 in (300 mm) or 20 in (500 mm), aviation orange marker balls are sufficient. One near the rabbit ears, two in the middle of the back cables and two in the middle of the highest overhang cables. Refer to Section 3.5 in AC70/7460-1 for additional details. Aviation marker balls are available online and from a variety of aviation and airport safety equipment providers.

# Valley ClassicPlus Control Panel

---

## Safety

### Overhead Power Lines

Assembling, towing or transporting irrigation machine components such as but not limited to the pivot point, linear cart, span/drive unit assemblies, overhangs and/or corner assemblies underneath or near power lines is extremely dangerous because of the risk of electrocution.

Operating equipment that elevates irrigation machine components, such as but not limited to an aerial lift or crane, near power lines is extremely dangerous because of the risk of electrocution. Only qualified personnel should operate this type of equipment. Before operating the equipment, qualified personnel must read the equipment manufacturers' operating and safety instructions.

Refer to U.S. Occupational Safety & Health Administration (OSHA) Regulations (Standards - 29 CFR) Cranes and derricks. - 1926.550, or any other applicable national, state or local regulations for additional information.

- Always presume that any overhead power line is an energized line unless and until the person(s) owning the line and/or the electrical utility authorities indicate that it is not an energized line and it has been visibly grounded.
- Before operating any equipment near any power line make sure the line has been de-energized and visibly grounded at the point of work.
- Electrocution can occur without touching an electrical power line. Electricity, depending on the magnitude, can jump or become induced into equipment or conductive materials that come in close proximity to, but do not touch a power line. High wind, lightning, wet ground and other environmental conditions will increase the possibility of electrocution and require additional consideration.
- Transmitter towers can induce the equipment or materials being handled with an electrical charge. Before working or operating equipment near transmitter towers, make sure the transmitter is de-energized.
- Select the location where the span/drive unit will be assembled to ensure that neither the irrigation machine, or the equipment used during the assembly process, will violate the minimum clearance guidelines.
- Never operate equipment or allow the load, ropes or tag lines within 10 ft (3.05 m) of any power line rated 50 kV or lower whether it is energized or not. For lines rated over 50 kV, the minimum clearance shall be 10 ft (3.05 m) plus 0.4 inch (1.1 cm) for each kV over 50 kVs.
- Never assemble, tow, transport or allow irrigation machine components underneath or within 10 ft (3.05 m) of any power line rated 50 kV or lower whether it is energized or not. For lines rated over 50 kV, the minimum clearance shall be 10 ft (3.05 m) plus 0.4 inch (1.1 cm) for each kV over 50 kVs. Overhang support angles, cables and spinner drive components regularly extend 10 ft to 12 ft (3.1 m to 3.7 m) above the irrigation pipeline (span).
- Use barricades to identify areas where interference with overhead power lines could occur. Keep the assembly, towing or transporting of irrigation machine components and the operation of equipment including load, ropes or tag lines away from any power line, in the distances described above, whether the line is energized or not.
- Always designate a person to observe clearance between the power line and all equipment being operated or moved in order to give timely warning for all operations to STOP if the minimum clearance is violated.

# Valley ClassicPlus Control Panel

## Safety

### Minimal Lockout / Tagout Procedure

The following procedure establishes the minimum requirements for the lockout of energy isolating devices whenever maintenance or servicing is done on machines or equipment. It is used to ensure that the machine or equipment is stopped, isolated from all potentially hazardous energy sources and locked out before personnel perform any servicing or maintenance where the unexpectedly energized or start-up of the machine or equipment or release of stored energy could cause injury. All personnel, upon observing a machine or piece of equipment which is locked out to perform servicing or maintenance shall not attempt to start, energize, or use that machine or equipment.

When the energy isolating devices are not lockable, tagout should be used and affected personnel must wear full personal protection.

Refer to U.S. Occupational Safety & Health Administration (OSHA) Regulations (Standards - 29 CFR) Typical minimal lockout procedures - 1910.147 App A, or applicable national, state or local regulations, for additional information.

### Sequence of Lockout

1. Notify all affected personnel that servicing or maintenance is required on a machine or equipment and that the machine or equipment must be shut down and locked out to perform the servicing or maintenance.
2. The authorized personnel shall identify the type and magnitude of the energy that the machine or equipment utilizes, shall understand the hazards of the energy, and shall know the methods to control the energy.
3. If the machine or equipment is operating, shut it down by the normal stopping procedure (depress the stop button, open switch, close valve, etc.).
4. De-activate the energy isolating device(s) so that the machine or equipment is isolated from the energy source(s).
5. Lock out the energy isolating device(s) with assigned individual lock(s).
6. Stored or residual energy (such as that in capacitors, springs, elevated machine members, rotating fly-wheels, hydraulic systems, and air, gas, steam, or water pressure, etc.) must be dissipated or restrained by methods such as grounding, repositioning, blocking, bleeding down, etc.
7. Ensure that the equipment is disconnected from the energy source(s) by first checking that no personnel are exposed, then verify the isolation of the equipment by operating the push button or other normal operating control(s) or by testing to make certain the equipment will not operate.

### CAUTION

- RETURN OPERATING CONTROL(S) TO NEUTRAL OR "OFF" POSITION AFTER VERIFYING THE ISOLATION OF THE EQUIPMENT.

8. The machine or equipment is now locked out.

### DANGER

- WHEN PERSONNEL WILL BE EXPOSED TO CIRCUIT ELEMENTS AND ELECTRICAL PARTS, A QUALIFIED PERSON MUST USE TEST EQUIPMENT TO VERIFY THAT THE CIRCUIT ELEMENTS AND EQUIPMENT PARTS OF THE EQUIPMENT ARE DE-ENERGIZED.

### Restoring Equipment to Service

When the servicing or maintenance is completed and the machine or equipment is ready to return to normal operating condition, the following steps shall be taken:

1. Check the machine or equipment and the immediate area around the machine to ensure that non-essential items are removed and that the machine or equipment components are operationally intact.
2. Check the work area to ensure that all personnel are safely positioned or removed from the area.
3. Verify that the controls are in neutral.
4. Remove the lockout devices and re-energize the machine or equipment.
5. Notify affected personnel that the servicing or maintenance is completed and the machine or equipment is ready to be used.

# Safety

## Operate Safely

Valley Irrigation machines are designed with safety in mind. However, if this machine is operated incorrectly, it may pose a safety threat to the operator. A good safety program is much like a chain, it is only as strong as its weakest link. The manufacturer, dealer, and operator must maintain and improve all safety programs. Following is a list of safety operating tips which you and all other persons servicing or operating the machine must read and understand:

### CAUTION

- DO NOT OPERATE THIS MACHINE WITHOUT FIRST READING THE OWNER'S MANUALS FOR THE MACHINE.
- READ ALL SAFETY MESSAGES IN THIS MANUAL AND SAFETY SIGNS ON THE MACHINE.
- DO NOT LET ANYONE OPERATE THIS MACHINE WITHOUT PROPER INSTRUCTIONS.
- UNAUTHORIZED MODIFICATIONS MAY IMPAIR THE FUNCTION AND/OR SAFETY OF THE MACHINE.
- IF YOU DO NOT UNDERSTAND ANY PART OF THIS MANUAL, CONTACT YOUR VALLEY DEALER.

### EMPLOYEE INSTRUCTION ON SAFETY

It is very important to instruct your employees on the safe use of this equipment at the time of their initial assignment to operate it. DO NOT let anyone operate this equipment without proper instructions.

Safety training should be presented annually and the service manager should ensure employees fully understand the safety messages and what to do in case of emergencies.

### EMERGENCY STOPPING

The machine can be stopped at any time at any tower by turning the disconnect switch, located underneath the tower box, to the OFF position. Refer to Figure 12-1.

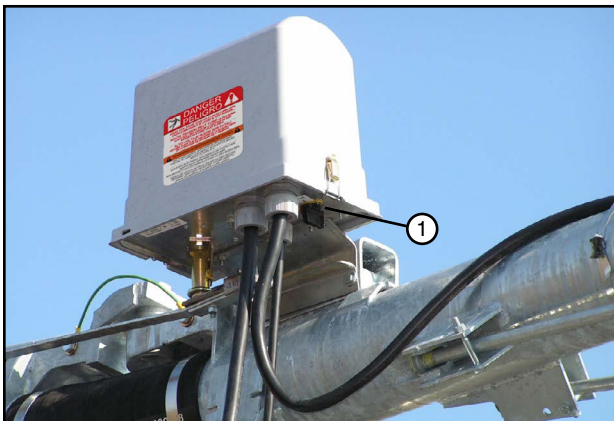

Figure 12-1 1. Disconnect Switch

### WARNING

#### PROPER GROUNDING

DO NOT attempt to start the machine until the electrical service is properly installed and grounded by a qualified electrician as per the electrical standards. Refer to Figure 12-2.

If the power supplied to the machine is not grounded properly, severe injury, or death can result should an electrical malfunction occur.

It is your responsibility to ensure that your power supplier and/or electrical contractor has grounded the irrigation machine as required by the National Electrical Code and by applicable local electrical codes. If a machine is properly grounded and fuse sizing is correct, there is extremely low probability of an individual being injured by electrical shock.

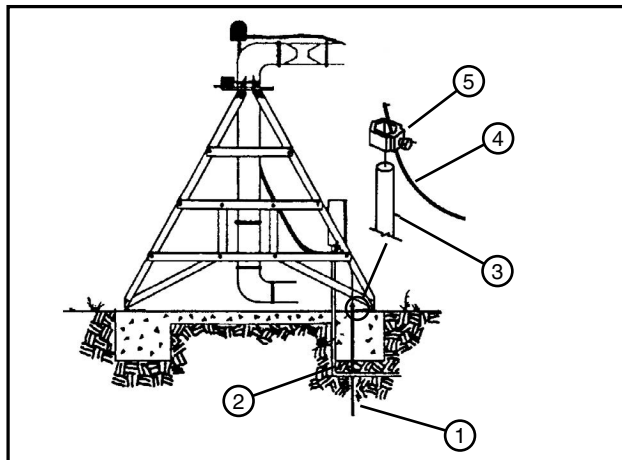

Figure 12-2 1. Ground Rod Installation 2. Service Conductor 3. Copper Ground Rod 4. Copper Ground Wire 5. Clamp

### NOTE

- All 480 VAC, 60 Hz (380 VAC, 50 Hz) power supply services MUST be a 4 conductor service. Three 480 VAC (380 VAC) power lines and one ground conductor which is as large as the power carrying conductors for that service.
- Each time a towable machine is moved, the ground wire MUST be reattached to the ground rod and checked for electrical integrity before restarting the machine.

## Operate Safely (Continued)

### **DANGER**

#### DISCONNECT POWER WHEN SERVICING

**ALWAYS** disconnect electrical power before servicing or performing maintenance to the machine.

If you are going to perform maintenance on the machine, **YOU MUST** shut off and lock the main power disconnect as shown below. Refer to Figure 13-1.

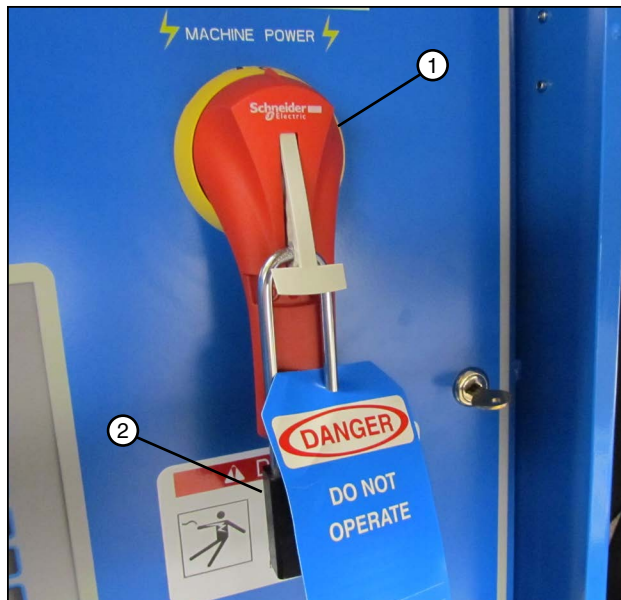

Figure 13-1 1. Main Power Disconnect  
2. Lock

The blue (OSHA safety color code) tag shown below should also be filled out and attached to the disconnect after locking. Refer to Figure 13-2.

The tag should reveal the name of a person to contact before restoring power to the machine.



Figure 13-2

### **CAUTION**

#### QUALIFIED SERVICE PERSONNEL

If you do not understand electricity or other parts of the machine, have qualified service personnel perform any hazardous repairs or maintenance.

### **CAUTION**

#### GUARD ALL POWER TAKE-OFF DRIVES

This includes all belt and power line drives.

Replace any guards and shields removed for maintenance.

### **WARNING**

#### MARK AND GUARD ALL POWER LINES

Do NOT deep rip or chisel near the buried power service wires.

Do NOT deep rip in a circle at the drive unit. The deep chisel track will cause severe stresses on the structure.

If you do deep rip your field, run the machine with the percent timer at 100% for the first revolution.

### **WARNING**

#### SUSPECTED SHORT CIRCUITS

DO NOT touch the machine if you suspect a short-circuit situation. Call a qualified electrician or an authorized Valley dealer immediately.

Circumstances which may cause you to suspect hazardous voltage situations may include:

- Physical damage to the machine or span cable
- Recent electrical storms (lightning)
- Unusual operating characteristics of the machine

If you suspect a short circuit due to feeling a rippling tingle when touching the machine, DO NOT touch the machine again. Call a qualified electrician or an authorized Valley dealer immediately.

# Safety

## Operate Safely (Continued)

### **WARNING**

#### **LIGHTNING AND THE MACHINE**

Stay away from the machine during an electrical storm. An irrigation machine makes a good path to earth. It is also probably the tallest object in the field, which makes it a good lightning receptor!

### **CAUTION**

#### **DO NOT OVERSIZE FUSES**

Fuses are sized for the protection of a specific machine.

Be certain you have the proper fuse sizes in place before initial start-up and when replacing fuses.

### **CAUTION**

#### **PLUG - IN CONNECTORS**

Disconnect power before connecting or disconnecting any plug-in connectors.

### **CAUTION**

#### **DO NOT OPERATE AT FREEZING TEMPERATURES**

Spraying water has a cooling effect and water will freeze even though the air temperature is slightly above freezing.

Shut the machine down at 40 degrees Fahrenheit (4.5 degrees Celsius). Do not operate machine when temperature is below 40° F (4.5° C).

- **DAMAGE TO EQUIPMENT RESULTING FROM FREEZE-UP IS NOT COVERED UNDER WARRANTY.**
- **IT IS IMPORTANT TO MAKE SURE ALL PIPE DRAINS FUNCTION PROPERLY TO PREVENT PIPELINE FREEZE-UP DURING COLD WEATHER.**

### **CAUTION**

#### **AVOID HIGH PRESSURE WATER STREAMS**

Avoid body contact with high pressure water streams.

### **WARNING**

#### **AVOID CHEMICALS**

Avoid exposure to sprinkler spray while chemicals are being injected into the water. Read EPA Label Improvement Program (PR Notice 87-1) and all instructions for chemical applications.

If you plan on chemigating, make certain you have complied with state or local regulations in regard to safety equipment, certification, operation and calibration of the injector pump. Make certain you have first aid and fresh water available in case of an accident. You must also be familiar with the correct cleanup procedures in case of a spill.

- **USE OF PROTECTIVE CLOTHING IS RECOMMENDED WHEN HANDLING CHEMICALS. SAFETY GLASSES, GLOVES, AND PROTECTIVE OUTERWEAR SHOULD BE WORN WHEN HANDLING CHEMICALS.**
- **CONTAMINATION OF THE WATER SUPPLY MAY OCCUR IF EFFECTIVE SAFETY DEVICES ARE NOT INSTALLED/USED IN CONNECTION WITH INJECTION EQUIPMENT FOR CHEMIGATION.**

### **DANGER**

#### **DRIVE SHAFTS START WITHOUT WARNING**

An electric motor on each tower of the center pivot powers two or more drive shafts connected to wheel gear drives. These drive shafts start and stop without warning.

- **DO NOT TOUCH ROTATING DRIVE SHAFT OR SHIELD, CLOTHING OR LIMBS MAY BECOME ENTANGLED, RESULTING IN SEVERE INJURY.**
- **DO NOT SERVICE THE MACHINE UNTIL THE MAIN DISCONNECT IS LOCKED IN THE OFF POSITION.**
- **ALWAYS REPLACE DRIVE SHAFT SHIELDS AFTER SERVICING.**
- **DRIVE SHAFT SHIELDS MUST ALWAYS BE IN PLACE WHEN OPERATING THE MACHINE.**

## Operate Safely (Continued)

### CAUTION

#### CHECK WHEEL TRACKS BEFORE STARTING

Make sure all objects, livestock or persons are clear of the machine before starting. Drive trains are powerful and can climb over vehicles, equipment, etc.

### CAUTION

#### KEEP CHILDREN AWAY

Pivots are NOT playground equipment.

Prevent children from playing or climbing around on the machine. This can be extremely dangerous, especially if the machine is operating.

### CAUTION

#### CHECK MACHINE DIRECTION

DO NOT operate the machine if it moves in the direction opposite to that which was chosen.

Forward should be clockwise, and reverse should be counter-clockwise.

### CAUTION

#### KEEP WATER OFF ROADWAYS

It is against the law in most states to allow water to spray on state and county roadways. This is a serious hazard to passing motorists.

If end guns are used, make sure you read and understand the correct procedures for setting the on and off positions to avoid watering the roadways.

If an end gun is watering a roadway, immediately discontinue use and adjust the shutoff setting or call your Valley dealer to repair the end gun shut off mechanism.

### CAUTION

#### AUTO REVERSE OPERATION SAFETY

If the machine reverses direction at a roadway or a physical object such as a building, tree line, power pole, etc., then you **MUST** provide a backup device to stop the machine if the reversing mechanism were to fail. Refer to Figure 15-1.

Contact your Valley dealer for more information concerning physical barricades for machines under these circumstances.



Figure 15-1 1. Physical Barricade

### CAUTION

#### PROPER USE OF THE SAFETY OVERRIDE

Caution **MUST** be taken by the operator when using the safety override function as it will bypass or disable all of the machine's automatic safety shutdown circuits.

- **NEVER DEPRESS AND HOLD THE START/STOP SAFETY OVERRIDE SWITCH IN THE START POSITION FOR MORE THAN 3 TO 5 SECONDS.**

If the machine is not in full view by the operator, do not use the Safety Override function.

The operator **MUST** inspect the entire machine between each safety override start attempt.

Repeated safety override start attempts can cause severe structural damage.

Call your Valley dealer if the machine fails to start.

# Safety

## Safety Decals

These Danger, Warning, and Caution decals appear in various locations on a Valley irrigation machine. You MUST familiarize yourself and other operator's with these safety decals. For replacement of any decal, contact your local Valley dealer.

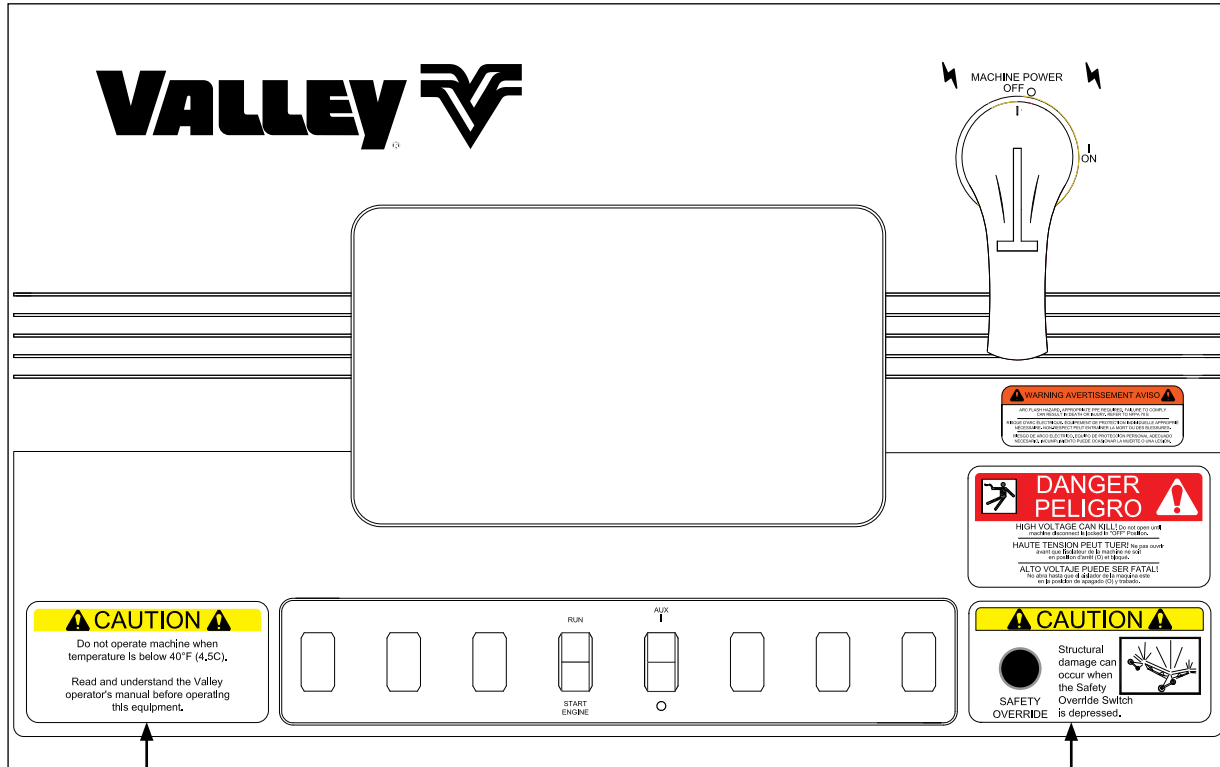

**CAUTION**

Do not operate machine when temperature is below 40°F (4.5C).  
Read and understand the Valley operator's manual before operating this equipment.

**CAUTION**

Structural damage can occur when the Safety Override Switch is depressed.

**DANGER PELIGRO**

**HIGH VOLTAGE CAN KILL!** Do not open until machine disconnect is locked in "OFF" Position.  
**HAUTE TENSION PEUT TUER!** Ne pas ouvrir avant que l'isolateur de la machine ne soit en position d'arrêt (O) et bloqué.  
**ALTO VOLTAJE PUEDE SER FATAL!** No abra hasta que el aislador de la máquina este en la posición de apagado (O) y trabado.

**WARNING AVERTISSEMENT AVISO**

ARC FLASH HAZARD, APPROPRIATE PPE REQUIRED, FAILURE TO COMPLY CAN RESULT IN DEATH OR INJURY. REFER TO NFPA 70 E  
QUE D'ARC ÉLECTRIQUE, ÉQUIPEMENT DE PROTECTION INDIVIDUELLE APPROPRIÉ NÉCESSAIRE, NON-RESPECT PEUT ENTRAÎNER LA MORT OU DES BLESSURES.  
RIESGO DE ARCO ELÉCTRICO, EQUIPO DE PROTECCIÓN PERSONAL ADECUADO NECESARIO. INCUMPLIMIENTO PUEDE OCASIONAR LA MUERTE O UNA LESIÓN.



Safety Decals (Continued)

**DANGER PELIGRO**

HIGH VOLTAGE CAN KILL! DO NOT OPEN UNTIL MACHINE DISCONNECT IS LOCKED IN "OFF" POSITION.  
 HAUTE TENSION PEUT TUER! NE PAS OUVRIR AVANT QUE L'ISOLATEUR DE LA MACHINE NE SOIT EN POSITION D'ARRÊT (O) ET BLOQUÉ.  
 ALTO VOLTAJE PUEDE SER FATAL! NO ABRA HASTA QUE EL AISLADOR DE LA MAQUINA ESTE EN LA POSICION DE APAGADO (O) Y TRABADO.

**WARNING AVERTISSEMENT AVISO**

ARC FLASH HAZARD, APPROPRIATE PPE REQUIRED. FAILURE TO COMPLY CAN RESULT IN DEATH OR INJURY. REFER TO NFPA 70 E  
 RISQUE D'ARC ÉLECTRIQUE. ÉQUIPEMENT DE PROTECTION INDIVIDUELLE APPROPRIÉ NÉCESSAIRE. NON-RESPECT PEUT ENTRAÎNER LA MORT OU DES BLESSURES.  
 RIESGO DE ARCO ELÉCTRICO. EQUIPO DE PROTECCIÓN PERSONAL ADECUADO NECESARIO. INCUMPLIMIENTO PUEDE OCASIONAR LA MUERTE O UNA LESIÓN.

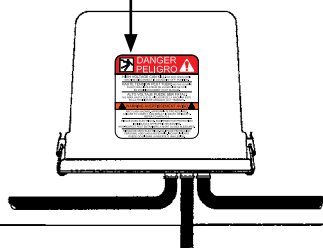
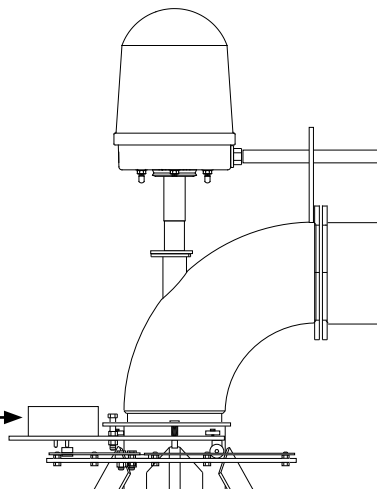

**WARNING**

TIRE AND RIM FOR IRRIGATION USE ONLY. ADJUST PRESSURE BEFORE USE. SEE OWNERS MANUAL FOR RECOMMENDED PRESSURE. 18 PSI [1.2 BAR] MAXIMUM

**VALLEY**

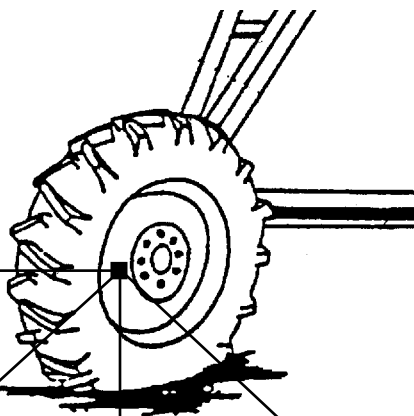

**WARNING**

TIRE AND RIM FOR IRRIGATION USE ONLY. ADJUST PRESSURE BEFORE USE. SEE OWNERS MANUAL FOR RECOMMENDED PRESSURE. 23 PSI [1.6 BAR] MAXIMUM

**VALLEY**

**WARNING**

TIRE AND RIM FOR IRRIGATION USE ONLY. ADJUST PRESSURE BEFORE USE. SEE OWNERS MANUAL FOR RECOMMENDED PRESSURE. 30 PSI [2.1 BAR] MAXIMUM

**VALLEY**

**WARNING**

TIRE AND RIM FOR IRRIGATION USE ONLY. ADJUST PRESSURE BEFORE USE. SEE OWNERS MANUAL FOR RECOMMENDED PRESSURE. 34 PSI [2.3 BAR] MAXIMUM



**VALLEY**

# Safety

## Safety Decals (Continued)

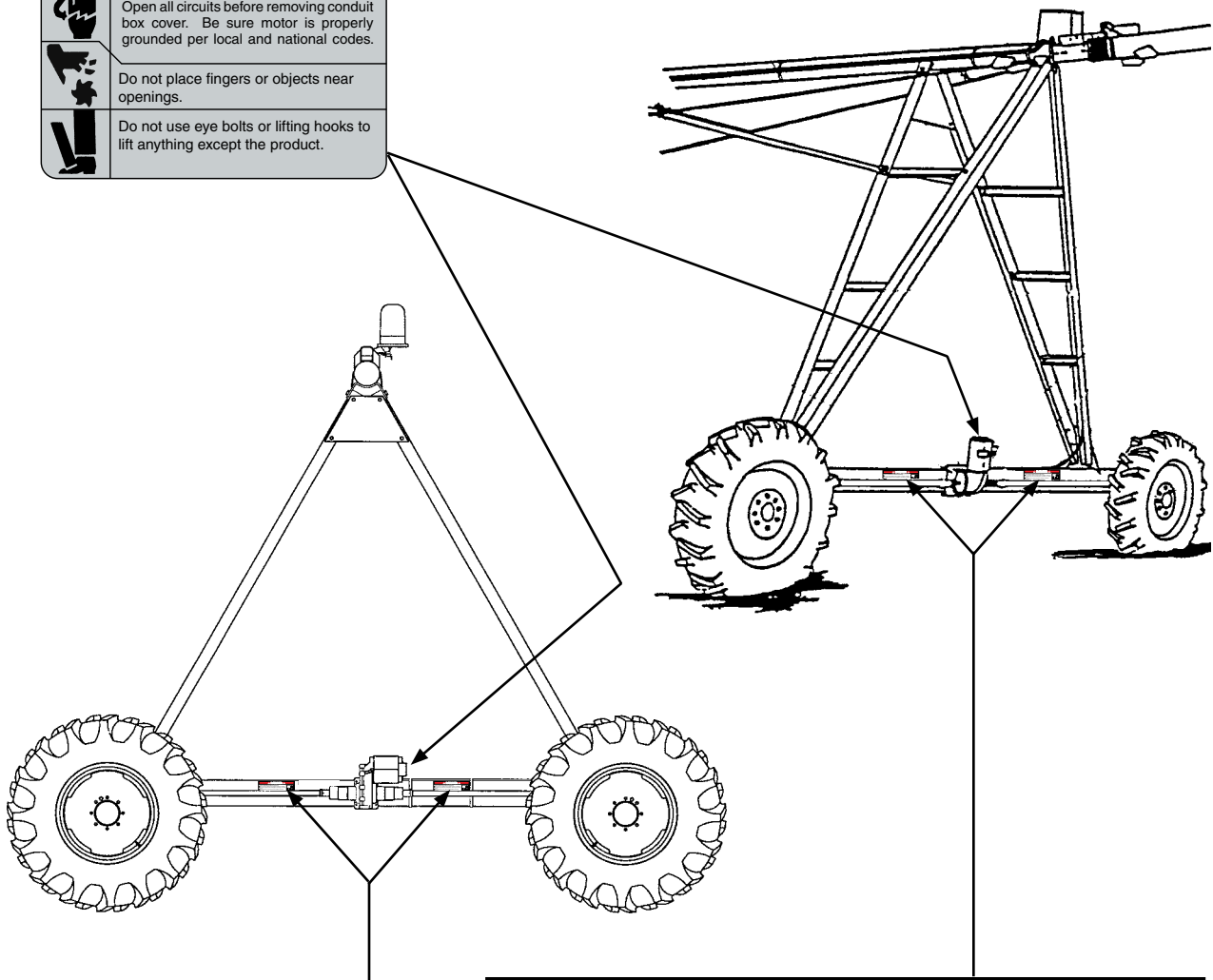
 <b>WARNING</b>	
Improper installation of this motor may result in fire, explosion, electrical shock or other personal injuries. Read operating instructions.	
	Disconnect power before maintenance. Open all circuits before removing conduit box cover. Be sure motor is properly grounded per local and national codes.
	Do not place fingers or objects near openings.
	Do not use eye bolts or lifting hooks to lift anything except the product.

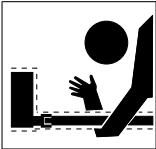

 <b>DANGER</b> 	
<b>Drive Shaft Starts Without Warning!</b>	
<ul style="list-style-type: none"><li>Do not touch rotating drive shaft or shield. Clothing or limbs may become entangled, resulting in severe injury.</li><li>Do not service until machine is locked in the off position.</li><li>Always replace drive shaft shield after servicing.</li></ul>	

# Valley ClassicPlus Control Panel

## Overview

### Controls and Components

The inside door of the ClassicPlus control panel is shown below in Figure 19-1.

## **⚠ DANGER**

- **480 VOLTS – DO NOT OPEN THE INTERIOR CONTROL PANEL DOOR, ELECTRICAL SHOCK MAY OCCUR.**
- **ALL NEEDED CONTROLS AND MONITORING DEVICES ARE ON THE OUTSIDE OF THE INTERIOR CONTROL PANEL DOOR.**
- **SERVICE WORK DONE ON THE CONTROL PANEL IS TO BE PERFORMED BY A QUALIFIED SERVICE PERSON ONLY.**

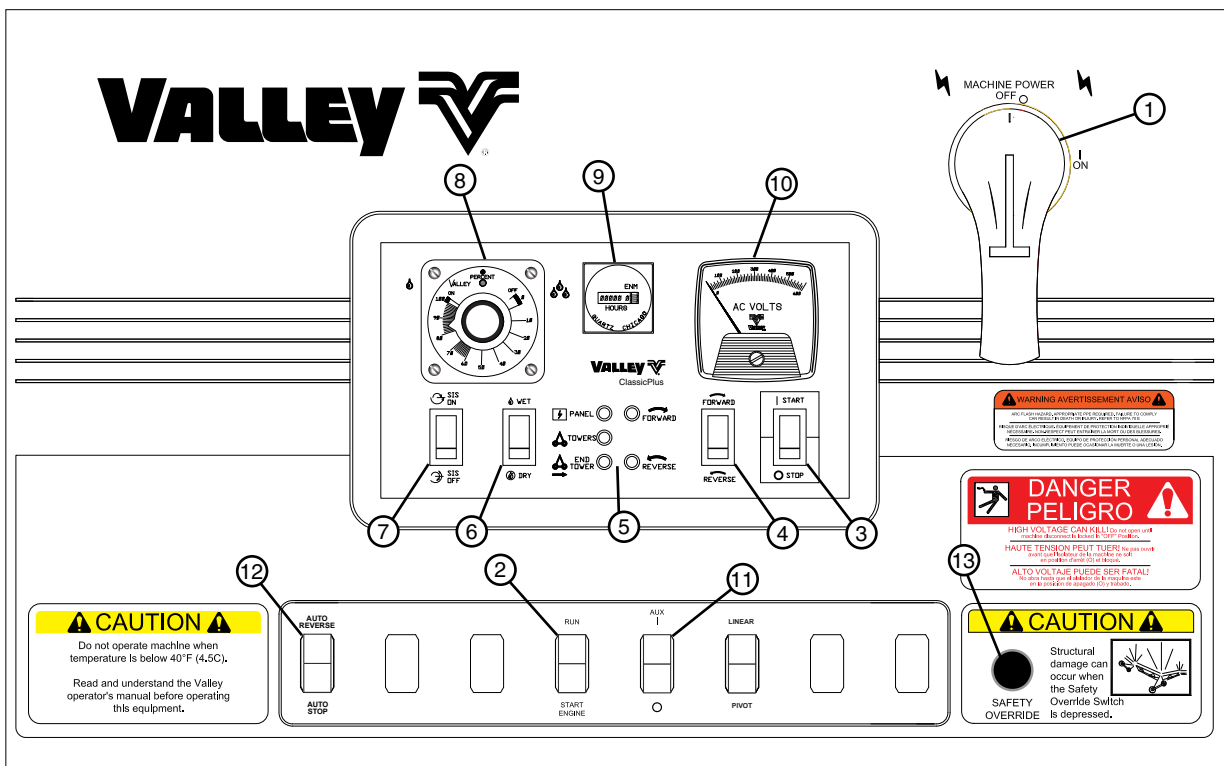

Figure 19-1

1. Main Disconnect	6. Wet/Dry Switch	10. Voltage Meter
2. Engine Run/Start Switch	7. Stop-In-Slot Switch	11. Auxiliary Switch (Optional)
3. Start-Stop Switch	8. Percentage Timer	12. Auto Reverse/Auto Stop Switch (Optional)
4. Forward/Reverse Direction Switch	9. Hour Meter	13. Safety Override Button
5. Indicator Lights		

# Valley ClassicPlus Control Panel

## Overview

### Main Disconnect Switch

This switch disconnects all power to the system except at the incoming (upper) terminals on the Main Disconnect Switch inside the control panel. See Figure 20-1.

The function of the disconnect is to turn the power OFF when doing any maintenance or repairs and when the system is not in use.

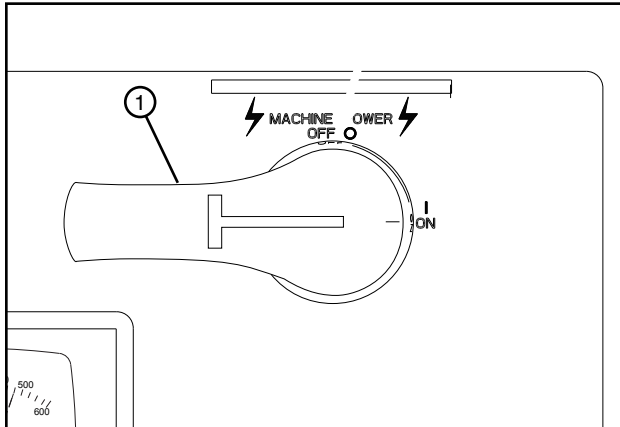

Figure 20-1 Main Disconnect Shown in the On Position  
1. Main Disconnect

### 3 Second Auto Restart

A three second auto restart is standard equipment built into the circuitry of the Valley system.

In the event of a momentary power loss or voltage drop while the machine is running, the system will automatically restart if power is returned within three seconds.

## ⚠ CAUTION

•TO REDUCE THE POSSIBILITY OF DAMAGE TO AN AUTOMATICALLY CONTROLLED ELECTRIC PUMP DUE TO A MOMENTARY POWER LOSS OF 3 SECONDS OR LESS, A PUMP RESTART DELAY TIMER IS REQUIRED IN THE PUMP CIRCUIT BETWEEN THE PIVOT CONTROL PANEL AND THE PUMP.

### Start-Stop Switch

Starts and stops the system. See Figure 20-2.

To start the system, the switch is moved from the STOP to the START position.

The switch should be pressed for approximately 1-2 seconds and then released at which time the switch will return to a center neutral "RUN" position.

To stop the system, move the switch to the STOP position.

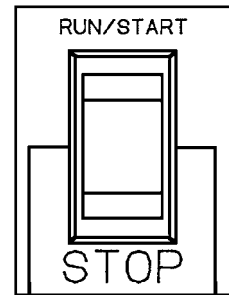

Figure 20-2

### Forward/Reverse Switch

Enables the operator to run the system in the forward (clockwise) or reverse (counter clockwise) direction assuming all safety circuits are complete. See Figure 20-3.

The direction of travel can be changed while the system is moving or selected before start-up.

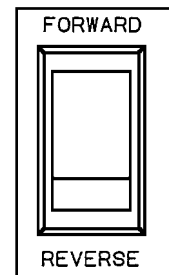

Figure 20-3

## NOTE

- If drive unit mounted auto reverse/auto stop option is ordered, this switch will be spring loaded.
- When the switch is depressed to the Forward or Reverse position, it will set the direction to Forward or Reverse respectively and then return to the central neutral position.
- The Start-Stop switch must be in the center neutral "RUN" position to change direction if drive unit mounted auto reverse/auto stop is installed.
- The standard switch (those panels ordered without the optional drive unit mounted auto reverse/auto stop) will either be in the Forward or Reverse position. It is NOT spring loaded.

# Valley ClassicPlus Control Panel

## Overview

### Wet/Dry Switch

By-passes the optional low pressure switch. See Figure 21-1.

The low pressure switch can be adjusted to close at a range of pressures.

For example, if the low pressure switch is set at 15 psi (103 kPa).

When the water pressure at the pressure switch location reaches 15 psi (103 kPa), the pressure switch will close which completes the safety circuit and allows the system to run.

Therefore, if the Wet/Dry switch was in the WET position and the pressure dropped below 15 psi (103 kPa), the system would shut down, thus providing the operator a low pressure shutdown.

However, if the operator wants to run the system dry (without water), the low pressure switch **MUST** be by-passed.

This can be accomplished by setting the Wet/Dry switch in the DRY position. The low pressure switch is then removed from the safety circuit and the system will run without water pressure.

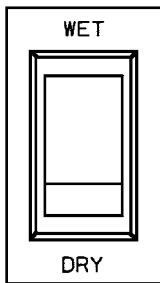

Figure 21-1

### NOTE

- If the Wet/Dry switch is left in the DRY position when the operator is applying water the system will NOT shut down if the pressure falls below the low pressure setting.

### SIS On/Off

Allows the optional stop-in-slot to be activated or by-passed. See Figure 21-2.

Stop-in-slot, stops the system at a preset location in the field (set by the operator) when the switch is in the ON position.

Setting the switch in the OFF position by-passes stop-in-slot, so the system will NOT stop at the preset location.

To set the stop location, refer to the End Gun Shut-Off and Stop In Slot Option section in The Valley Pivot System Owners Manual.

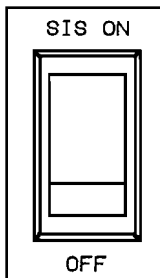

Figure 21-2

### Indicator Lights

The indicator lights give the operator some useful information about the system when it is running and also provides some diagnostic capabilities. See Figure 21-3.

- The Panel light is ON when the machine is running.
- The Towers light is ON when the machine is running.
- The End Tower light is ON when the end tower is moving.
- The Forward light is ON when the machine is moving in the forward direction.
- The Reverse light is ON when the machine is moving in the reverse direction.

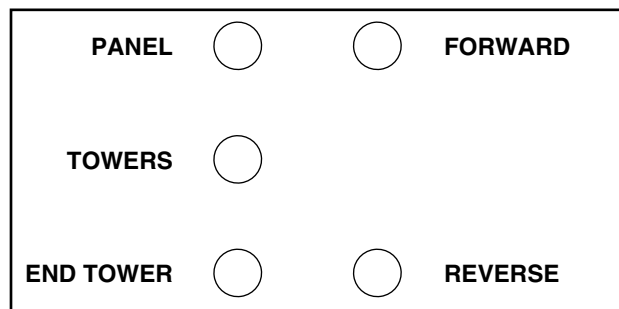

Figure 21-3

# Valley ClassicPlus Control Panel

## Overview

### Percentage Timer

The percentage timer regulates the revolution time of the system. See Figure 22-1.

The amount of water which the operator applies is determined by setting the percentage timer.

A percentage timer setting of 100 percent indicates the end tower of the system would move continuously, providing the shortest revolution time.

One hundred percent is also the setting at which the minimum amount of water can be applied.

If the percentage timer is set at 50 percent, the revolution time of the system and the water application amount is doubled. The end tower of the system would move for approximately 30 seconds out of each minute at a setting of 50%.

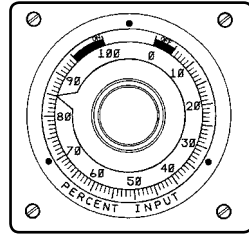

Figure 22-1

### NOTE

- The percentage timer determines the percentage of one minute which the end tower of the system will run, therefore, regulating the revolution time of the system.
- Refer to the system's sprinkler chart to provide water application amounts at different settings.
- The Percent Timer Setting Calculations section explains the calculation process for determining water applications at different percent timer settings.

### Hour Meter

Records the number of hours the system has operated, including both hours with and without water (or wet and dry time). See Figure 22-2.

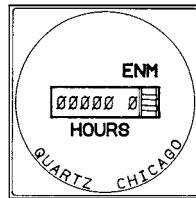

Figure 22-2

### Volt Meter

The volt meter displays the voltage being delivered to the machine from the control panel. See Figure 22-3.

The recommended operating voltage is the nominal supply voltage. See Figure 22-4.

During normal operation the meter should read approximately the nominal supply voltage. See Figure 22-4.

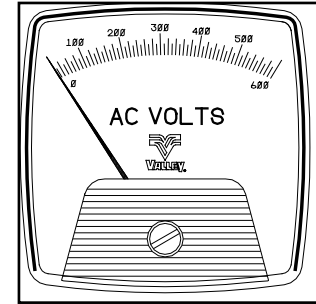

Figure 22-3

### NOTE

- Some long or high amperage machines may need to be run at a higher voltage but never at a voltage above the maximum allowed voltage.

### CAUTION

- DO NOT OPERATE THE MACHINE IF THE VOLT METER READS BELOW THE MINIMUM ALLOWED VOLTAGE OR ABOVE THE MAXIMUM ALLOWED VOLTAGE. SEE FIGURE 22-4.
- OPERATING THE MACHINE OUTSIDE THESE LIMITS COULD CAUSE DAMAGE TO THE DRIVE MOTORS AND OTHER ELECTRICAL COMPONENTS. SEE FIGURE 22-4.
- CORRECT THE LOW VOLTAGE PROBLEM BEFORE RESUMING OPERATION.

Nominal Supply Voltage	Maximum Allowed Voltage	Minimum Allowed Voltage
480 VAC @ 60 Hz	505 VAC	440 VAC
415 VAC @ 50 Hz	420 VAC	375 VAC
400 VAC @ 50 Hz	420 VAC	365 VAC
380 VAC @ 50 Hz	420 VAC	355 VAC
230 VAC @ 60 Hz	253 VAC	220 VAC
220 VAC @ 50 Hz	243 VAC	210 VAC
120 VAC @ 60 Hz	132 VAC	105 VAC
110 VAC @ 50 Hz	121 VAC	95 VAC

Figure 22-4

# Valley ClassicPlus Control Panel

## Overview

### Option Switches

The Valley ClassicPlus Control Panel incorporates eight expansion slots for optional switches as illustrated in Figure 23-1.

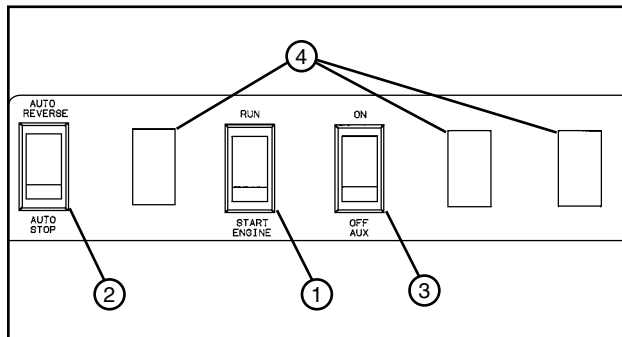

Figure 23-1 1. Run/Start Switch - Installed on all ClassicPlus Panels  
2. Auto Reverse/Auto Stop - Installed with the optional drive unit mounted auto reverse/auto stop hardware  
3. Auxiliary Switch - Installed with the optional auxiliary control  
4. Expansion Slots

### Engine Run/Start Switch

A standard engine RUN/START switch is installed for easy wiring of an engine shutdown circuit. See Figure 23-2.

If the switch is in the RUN position, the engine would shut down if the pivot system stops for some reason. The switch **MUST** be in the START position to start the engine.

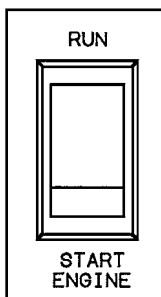

Figure 23-2

### Auxiliary On/Off Switch

This optional switch is available for such uses as injector pump operation, manual end gun control or other options the operator may decide to install. See Figure 23-3.

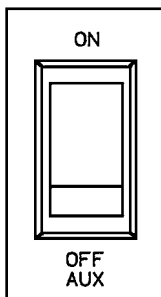

Figure 23-3

### Auto Reverse/Auto Stop Switch

This switch will only be installed if the optional drive unit mounted auto reverse/auto stop is ordered as illustrated in Figure 23-4.

In the Auto Reverse position, the system will run continuously, automatically reversing when either actuator arm is tripped.

In the Auto Stop position, the system will Stop when the actuator arm is tripped.

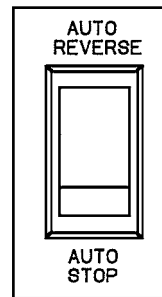

Figure 23-4

The Drive Unit Mounted Auto Reverse/Auto Stop assembly is used for both drive unit mounted end of field auto stop and drive unit mounted end of field auto reverse/auto stop (combined options). See Figure 23-5.

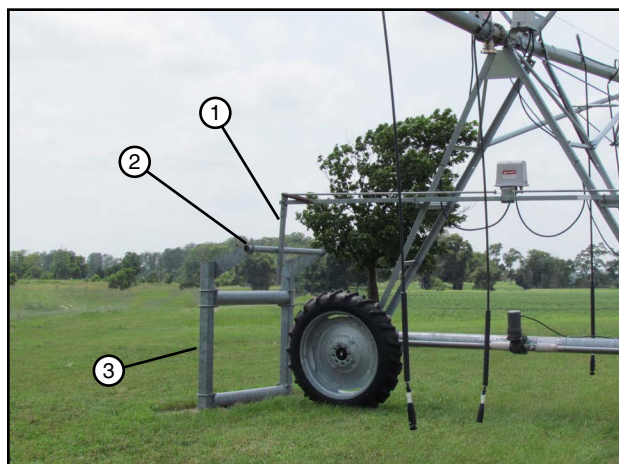

Figure 23-5 1. Actuator Arm  
2. Structure to Trip Actuator Arm  
3. Physical Barricade (Required)

The auto stop option will stop the system when the actuator arm contacts the barricade.

If the auto reverse/auto stop option is installed, the operator may choose to either stop the system when it reaches the barricade or have the system automatically reverse its direction of travel and continue to run.

This can be selected with the Auto Reverse/Auto Stop switch as illustrated in Figure 23-4.

## NOTE

- Care must be taken when this option is used.
- The operator **MUST** ensure the actuator arm contacts the tripping structure. Under certain conditions, soil may build up in the wheel track resulting in a ramp effect allowing the actuator arm to go over the tripping structure without tripping the actuator arm.

# Valley ClassicPlus Control Panel

---

## Overview



# Valley ClassicPlus Control Panel

## Operation

### Starting The System Wet (With Water)

1. Inspect the wheel tracks to ensure there are no vehicles or other equipment which will obstruct the system upon start-up or operation.
2. Place the WET/DRY switch in the DRY position to bypass the low pressure switch.
3. If an engine shutdown circuit is utilized, place the Engine RUN/START switch in the START position.
4. Partially close the mainline valve to the system. This will help to prevent “water hammer” if the pump is powered by an electric motor.
5. Start the pump. (The pump may be wired such that when the START switch on the center pivot control panel is pressed, the pump automatically starts. Check with your Valley dealer to determine how your pump has been wired into your control panel.)
6. Slowly introduce more water into the system by either opening the mainline valve or by increasing the engine speed. Examine the Valley System’s pressure gauge to ensure the desired operating pressure.
7. Turn the main disconnect switch to the ON position. If the power is supplied by an engine driven generator, adjust the RPM of the generator until the voltmeter reads 480 – 505 volts. DO NOT EXCEED 505 VOLTS.
8. Place the WET/DRY switch in the WET position.
9. Select the direction of travel by placing the FORWARD/REVERSE switch in either the FORWARD or REVERSE position. Remember, Forward is clockwise and Reverse is counter-clockwise.
10. Press the START-STOP switch to the START location for 1 – 2 seconds and release. The system should now start.
11. Place the Engine RUN/START switch in the RUN position.
12. Set the percentage timer to the desired speed setting.
13. If the system is equipped with the optional stop-in-slot, place the SIS ON/OFF switch in the desired position.
14. If the system is equipped with the optional drive unit mounted auto reverse/auto stop hardware, place the Auto Reverse/Auto Stop switch in the desired position.

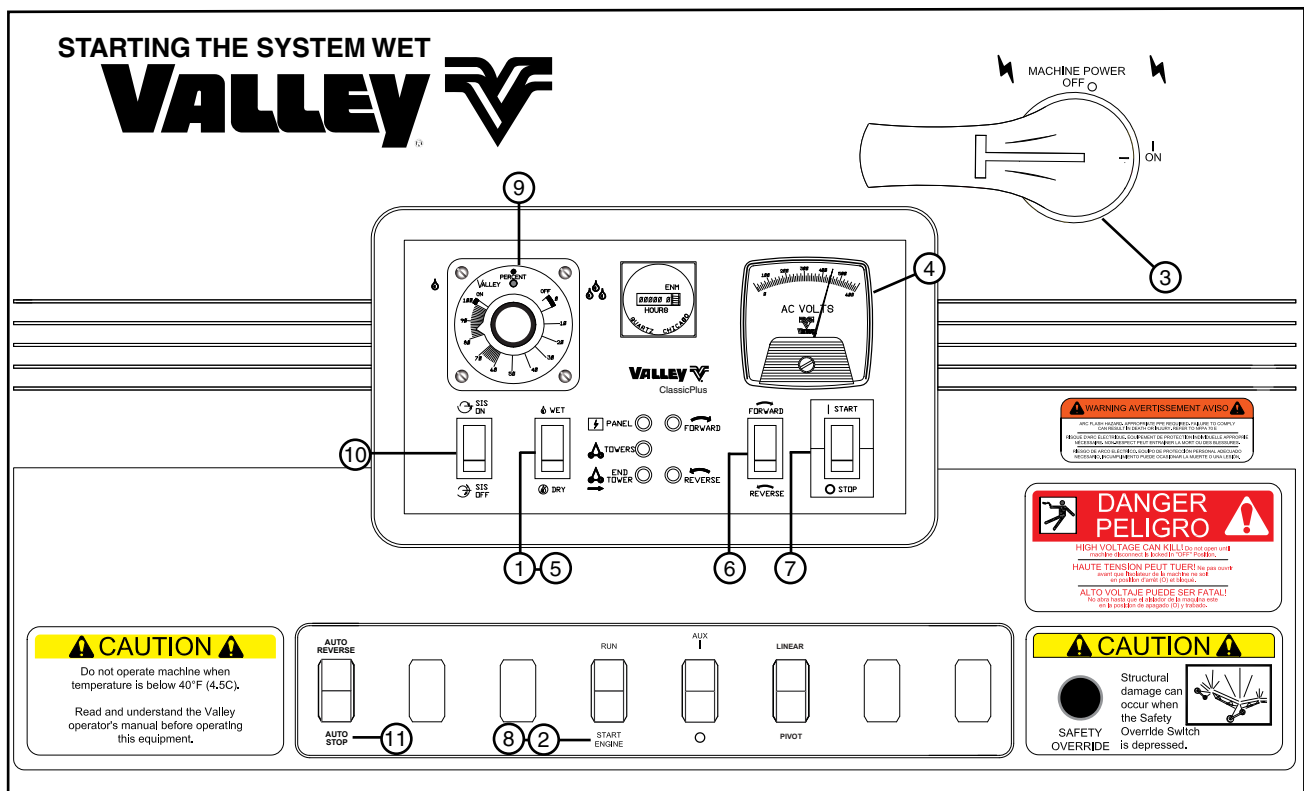

- Figure 25-1
1. Set to DRY
  2. Set to START
  3. Turn Main Disconnect to ON
  4. Voltmeter Reading between 480-505 Volts
  5. Set to WET
  6. Select Forward or Reverse Direction
  7. Press START for 1-2 Seconds to Start Machine
  8. Set to RUN
  9. Select Desired Percentage Timer Setting
  10. Set SIS to ON/OFF
  11. Select Auto Reverse or Auto Stop (if installed)

# Valley ClassicPlus Control Panel

## Operation

### Starting The System Dry (Without Water)

1. Inspect the wheel tracks to ensure there are no vehicles or other equipment which will obstruct the system upon start-up or operation.
2. Place the WET/DRY switch in the DRY position to by-pass the low pressure switch.
3. If an engine shutdown circuit is utilized, place the Engine RUN/START switch in the START position.
4. Turn the main disconnect switch to the ON position. If the power is supplied by an engine driven generator, adjust the RPM of the generator until the voltmeter reads 480 – 505 volts. DO NOT EXCEED 505 VOLTS.
5. Select the direction of travel by placing the FORWARD/REVERSE switch in either the FORWARD or REVERSE position. Remember, Forward is clockwise and Reverse is counter-clockwise.
6. Press the START-STOP switch to the START location for 1 – 2 seconds and release. The system should now start.
7. Place the Engine RUN/START switch in the RUN position.
8. Set the percentage timer to the desired speed setting.
9. If the system is equipped with the optional stop-in-slot, place the SIS ON/OFF switch in the desired position.
10. If the system is equipped with the optional drive unit mounted auto reverse/auto stop hardware, place the Auto Reverse/Auto Stop switch in the desired position.

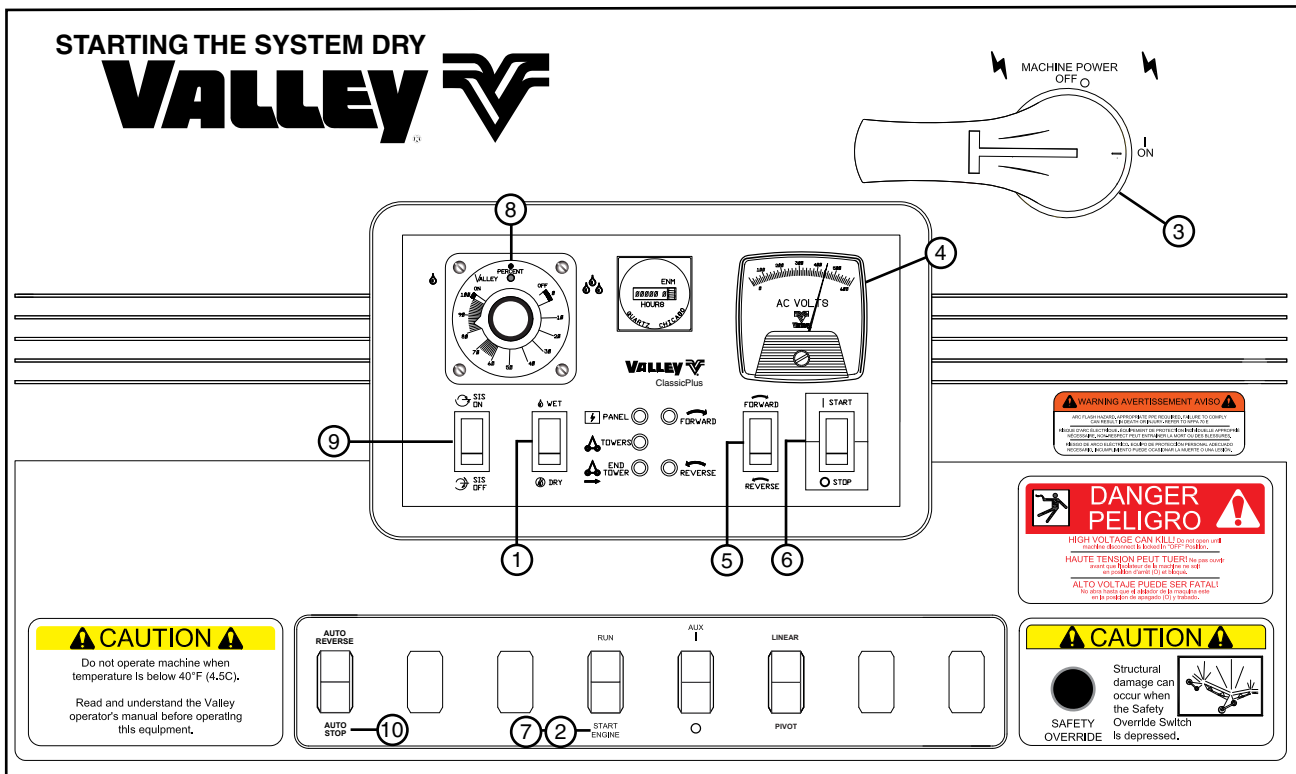

Figure 26-1

1. Set to DRY
2. Set to START
3. Turn Main Disconnect to ON
4. Voltmeter Reading between 480-505 Volts
5. Select Forward or Reverse Direction
6. Press START for 1-2 Seconds to Start Machine
7. Set to RUN
8. Select Desired Percentage Timer Setting
9. Set SIS to ON/OFF
10. Select Auto Reverse or Auto Stop (if installed)

# Valley ClassicPlus Control Panel

## Operation

### Stopping The Machine Emergency Stopping

To stop the machine in an emergency situation, shut off any one of the following:

- Main Service Disconnect Switch from public power to the control panel. See Figure 27-1.
- Control Panel Main Disconnect Switch. See Figure 27-1.
- Any Tower Box Disconnect Switch. See Figure 27-1.

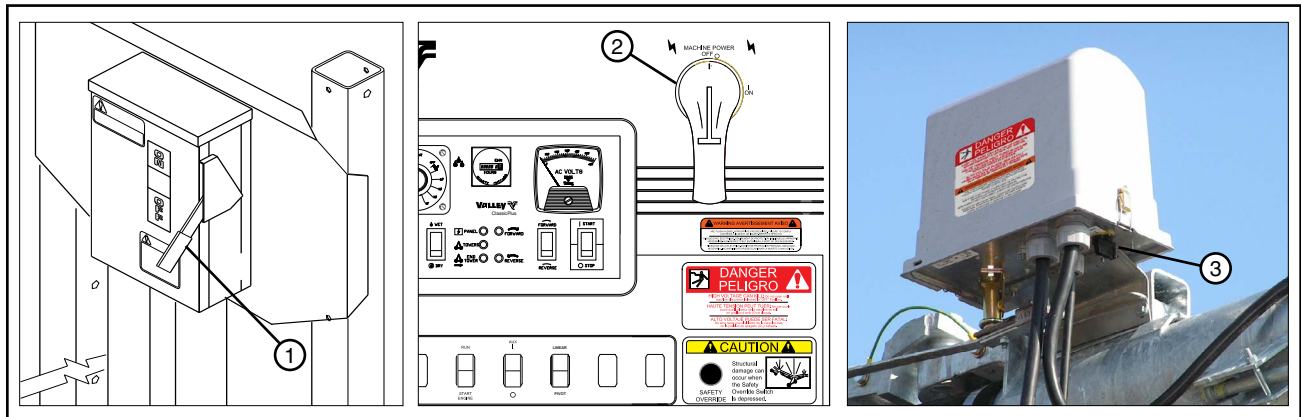

Figure 27-1 1. Main Service Disconnect Switch  
2. Control Panel Main Disconnect Switch  
3. Tower Box Disconnect Switch

### Stopping Under Normal Conditions

1. Press the START-STOP switch to the STOP position. See Figure 27-2.
2. Turn the main disconnect switch to the OFF position. See Figure 27-2.
3. Turn the pumping unit OFF (if not automatic).
4. If an engine generator set is utilized, place the Engine Run/Start switch to the Start position for the next start-up sequence.

#### **WARNING**

•DO NOT SHUT THE MACHINE OFF BY SLOWLY IDLING DOWN THE ENGINE GENERATOR SET. THIS PRACTICE CAUSES LOW VOLTAGE AND WILL DAMAGE MACHINE COMPONENTS.

•ALWAYS STOP THE IRRIGATION MACHINE PRIOR TO SHUTTING DOWN THE ENGINE-GENERATOR SET.

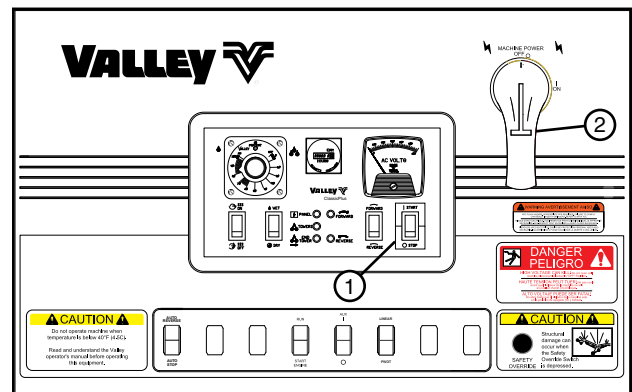

Figure 27-2 1. START-STOP Switch  
2. Main Disconnect Switch OFF

# Valley ClassicPlus Control Panel

## Operation

### Indicator Lights

The indicator lights give the operator information about the system when it is running and also provides some diagnostic capabilities.

### Panel and Towers Lights

The Panel and Tower lights will always be lit if the system is running. See Figure 28-1.

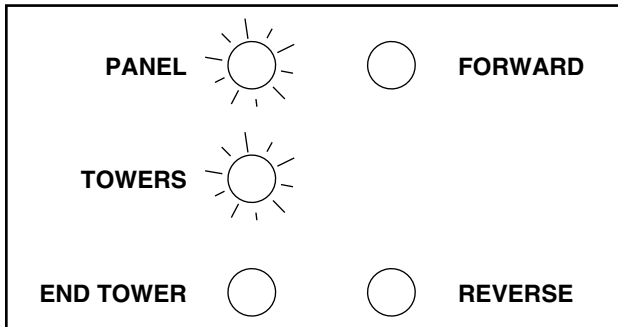

Figure 28-1

If a system will not start, the PANEL and TOWERS lights can be used to determine if the problem is in the control panel or on the system towers.

The following procedure explains the use of these two lights to determine the general cause of a system not starting:

Press the RUN/START switch for 1-2 seconds and watch the PANEL and TOWERS lights. Determine which of the following 3 cases apply:

1. If neither light is on during the 1-2 seconds, the problem is most likely in the control panel or with the incoming power. This would indicate power is not being sent out on the "safety line".
2. If the PANEL light is on during the 1-2 seconds but the TOWER light isn't, this would indicate that the safety circuit is not complete. The problem is that the safety circuit is not complete at one of the drive unit towers.
3. If both lights are on (PANEL and TOWERS) when the RUN/START switch is pressed but the system will still not start, the problem is most likely with the control panel.

## NOTE

•If the system fails to start, call your authorized Valley dealer and relay your observations of the "PANEL and TOWERS" lights during start-up procedure.

### End Tower Light

The END TOWER light will be on when the end tower is moving. See Figure 28-2.

- If the percentage timer is set at 100 percent, this light will be on continuously.
- If the percent timer is set at 50 percent, the light should be on approximately 30 seconds and off 30 seconds.

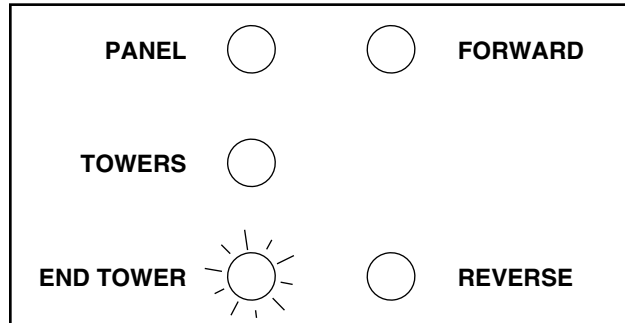

Figure 28-2

### Forward and Reverse Lights

Either the FORWARD or REVERSE light will be on when the system is running to indicate which direction the system is moving. See Figure 28-3.

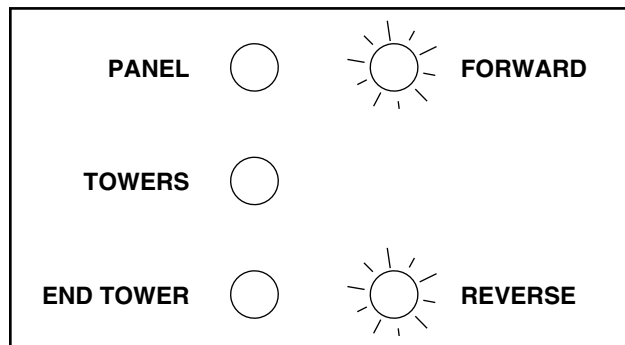

Figure 28-3

## NOTE

- If optional drive unit mounted auto reverse / auto stop is installed and the system stops for some reason, then these lights will indicate which direction the system was last running.
- If the system is powered with an engine driven generator, the operator simply restores power to the panel and either the FORWARD or REVERSE light will be lit to indicate which direction the system was last running.

# Valley ClassicPlus Control Panel

## Operation

### Safety Override Button

The Valley ClassicPlus Control Panel is equipped with a safety override push button switch. See Figures 29-1 and 29-2.

Should the system misalign for some reason and it is necessary to override the safety circuit momentarily to realign the system, this switch may be used.

To use the by-pass function, depress the safety override button in conjunction with the START switch.

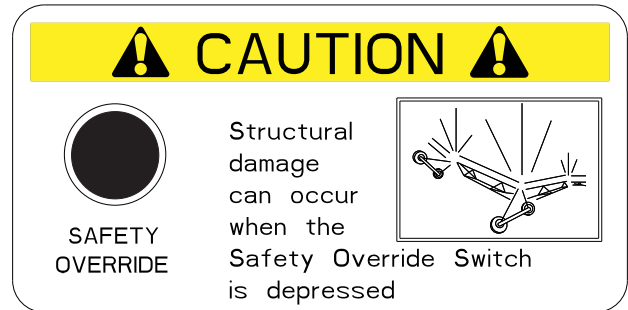

Figure 29-1 Caution Decal

**⚠ CAUTION**

- **CAUTION MUST BE TAKEN BY THE OPERATOR WHEN THIS BUTTON IS DEPRESSED AS IT WILL BY-PASS OR DISABLE ALL OF THE SYSTEM'S SAFETY CIRCUITS.**
- **NEVER DEPRESS THIS BUTTON FOR MORE THAN 3 TO 5 SECONDS.**
- **IF THE SYSTEM IS NOT IN FULL VIEW BY THE OPERATOR, IT IS NOT RECOMMENDED THAT THE SAFETY OVERRIDE SWITCH BE USED.**
- **THE OPERATOR MUST INSPECT THE ENTIRE SYSTEM BETWEEN EACH START ATTEMPT.**
- **REPEATED OVERRIDE START ATTEMPTS CAN CAUSE SEVERE STRUCTURAL DAMAGE.**
- **CALL THE LOCAL VALLEY DEALER SHOULD THE SYSTEM FAIL TO START.**

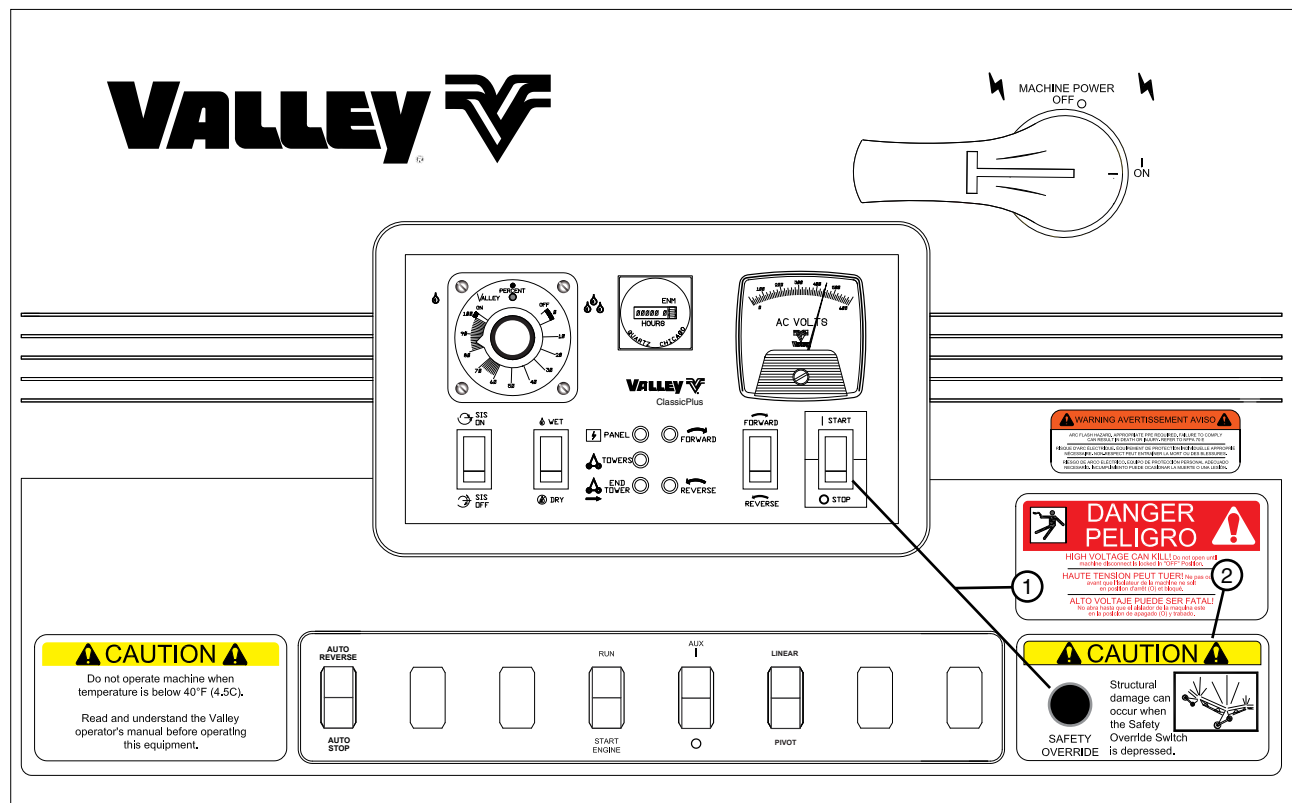

Figure 29-2 1. Press Simultaneously to Override Safety  
2. Notice Caution Decal

# Valley ClassicPlus Control Panel

## Operation

### Percent Timer

#### Theory of Operation

The percent timer controls the length of time that the last regular drive unit runs. Example: if a 60 second percent timer is set to 50%, during the 60 second cycle the last regular drive unit will run for 30 seconds and then stop for 30 seconds before starting the next cycle. Percent timers are available with 30, 60 90 or 120 second cycles.

#### Identifying Percent Timers

There are three solid state electronic percent timers.

#### Response to Change

##### Eagle Solid State Percent Timer Operation

- **Machine Stopped:** When a change is made to the Eagle solid state percent timer setting while the machine is stopped, the timer will finish the previous time cycle before starting the new percent timer setting when the machine is started.
- **Machine Running:** When a change is made to the Eagle solid state percent timer setting during operation, the change is not immediately recognized by the percent timer. First the percent timer completes the current cycle at the previous setting, then after the cycle ends the change is recognized and the percent timer begins working at the new setting.

##### ATC and Macromatic Solid State Percent Timer Operation

- **Machine Stopped:** When a change is made to the percent timer setting while the machine is stopped, the change is recognized immediately and when the machine is started the machine runs at the new percent timer setting.
- **Machine Running:** When a change is made to the percent timer setting during operation, the change is recognized immediately and the timer begins working on the new setting.

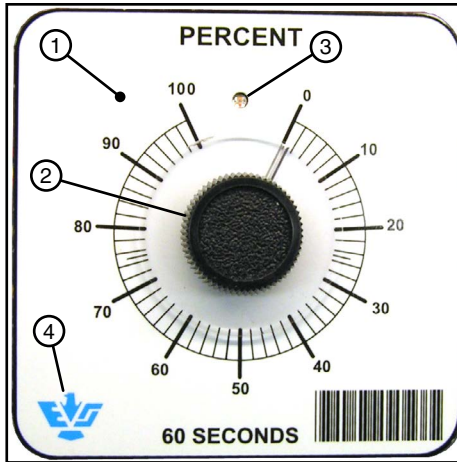

Figure 30-1 1. Eagle Solid State Percent Timer  
2. Dial  
3. Indicator Light  
4. Manufacturers Logo

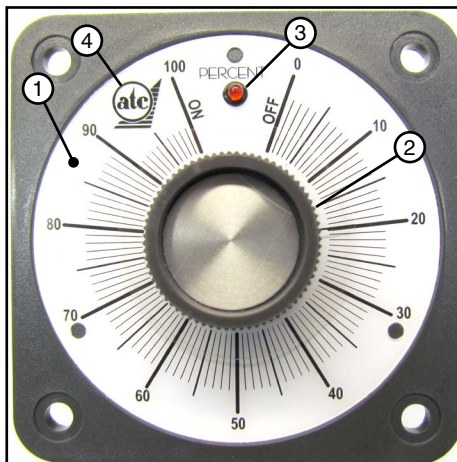

Figure 30-2 1. ATC Percent Time Shown  
2. Dial  
3. Indicator Light  
4. Manufacturers Logo

# Valley ClassicPlus Control Panel

## Operation

### Testing the Solid State Percent Timer

The percent timer should be tested for proper operation at the beginning of each growing season and then every month throughout the season.

To test the percent timer do the following:

1. Set the percent timer to 20% on the dial. See Figure 31-1.
2. Start the machine.
3. Watch the End Tower indicator light for several complete cycles (ON/OFF) of the timer to insure you catch a complete timer cycle. See Figure 31-1.
  - 60 second cycle timer, the End tower light should be ON for 12 seconds and OFF for 48 seconds. If the End Tower indicator light is ON for more than 13 seconds or less than 11 seconds the percent timer is not operating properly and must be replaced.
  - 120 second cycle timer, the End tower light should be ON for 24 seconds and OFF for 96 seconds. If the End Tower indicator light is ON for more than 26 seconds or less than 22 seconds the percent timer is not operating properly and must be replaced.
  - If the End Tower indicator light is ON or OFF continuously the percent timer is not operating properly and must be replaced.

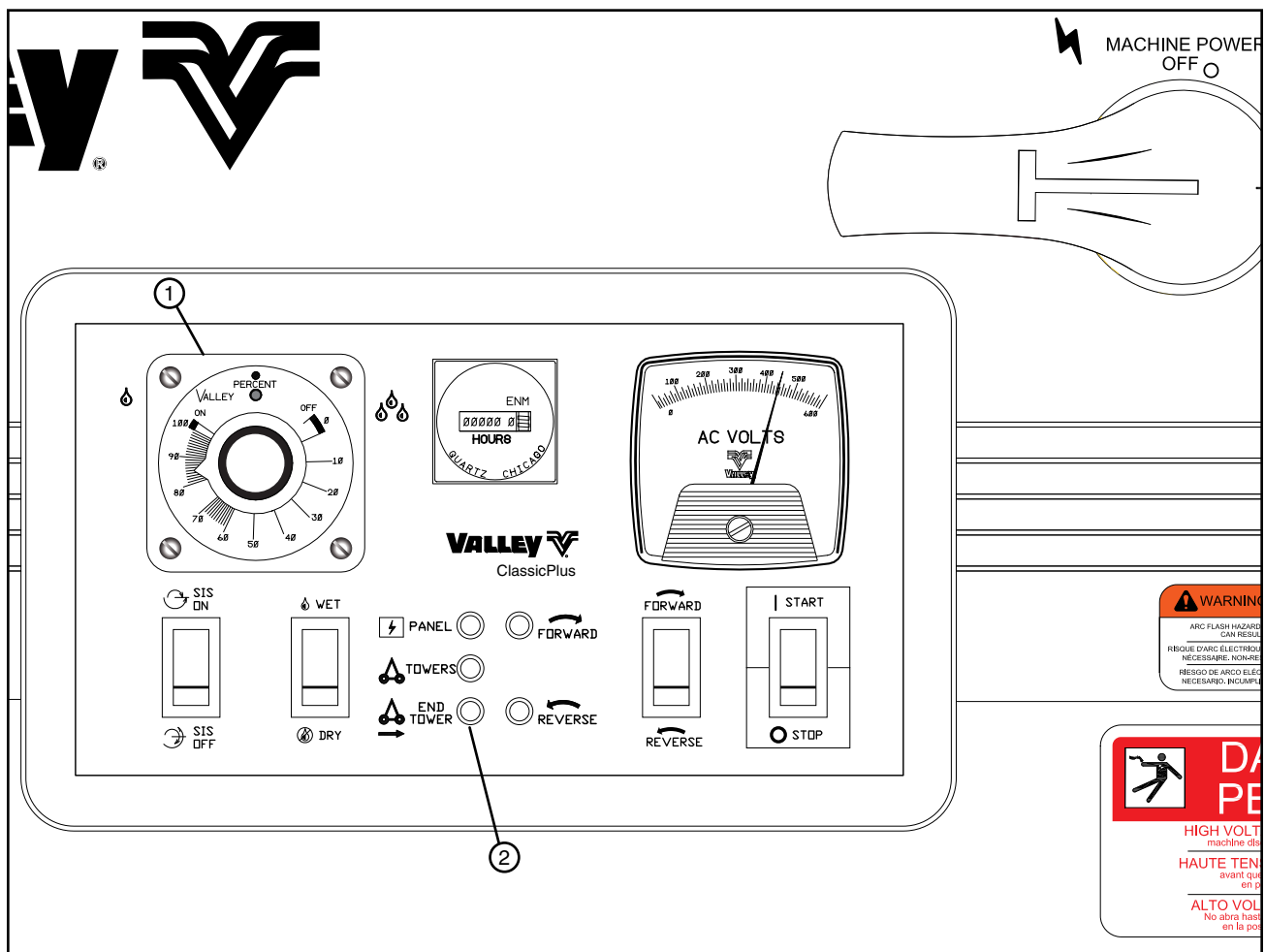

Figure 31-1 1. Percent Timer  
2. End Tower Indicator Light

# Valley ClassicPlus Control Panel

## Operation

### Percent Timer Setting Calculations

The percent timer regulates the system speed which controls the amount of water being applied per revolution.

A percent timer setting of 100% would indicate that the end tower moves continuously or 100% of the time.

A percent timer setting of 50% would indicate that the end tower runs 50% of the time or 30 seconds out of each minute, therefore, doubling the amount of water being applied.

A sprinkler chart like the one illustrated in Figure 32-1 will provide the operator with the necessary information to determine water application depths and revolution times at different percent timer settings.

INCHES(MM) PER REVOLUTION	PERCENT TIMER SETTING	HOURS PER REVOLUTION
0.15 (3.8)	100	21
0.20 (5.1)	77	28
0.30 (7.6)	51	41
0.40 (10.2)	39	55
0.50 (12.7)	31	69
0.60 (15.2)	26	83
0.70 (17.8)	96	96
0.80 (20.3)	19	110
0.90 (22.9)	17	124
1.00 (25.4)	15	138
1.25 (31.8)	12	172
1.50 (38.1)	10	207
1.75 (44.5)	9	241
2.00 (50.8)	8	276
2.50 (63.5)	6	345
3.00 (76.2)	5	413
3.50 (88.9)	4	482

Figure 32-1

If the system length, flow rate in GPM (LPS) and revolution times are known, these values can be calculated as described in the following procedure.

### 1. Determine The System Length.

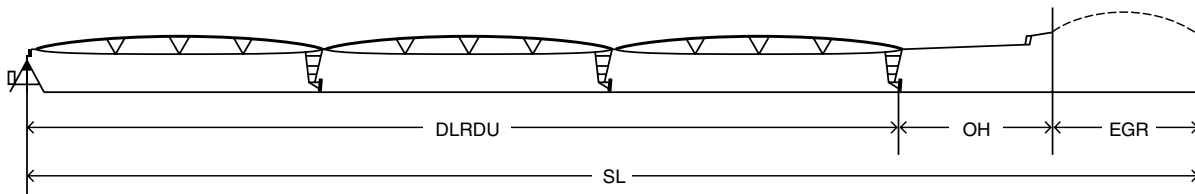

SL = Total System Length - ft (M)

DLRDU = Distance to the Last Regular Drive Unit - ft (M)

OH = Overhang Length - ft (M)

EGR = End Gun Radius - ft (M)

$$SL = DLRDU + OH + EGR$$

Example:

DLRDU = 1260 ft (384 M)

OH = 64 ft (20 M)

EGR = 100 ft (30 M)

$$SL = 1260 \text{ ft (384 M)} + 64 \text{ ft (20 M)} + 100 \text{ ft (30 M)}$$

$$SL = 1424 \text{ ft (434 M)}$$

Approximate End Gun Radius Coverages		
Rain Bird® 85	=	60 ft (18 M)
Rain Bird® 95	=	65 ft (20 M)
Nelson 100	=	100 ft (30 M)
Rain Bird® 03	=	100 ft (30 M)



# Valley ClassicPlus Control Panel

## Operation

### Percent Setting Timer Calculations (Continued)

2. Determine the End Tower Rotational Speed at 100% Timer Setting from the following chart:

Last Regular Drive Unit ***	Standard Tires 11.2 x 24		Retread 11 x 24.5		High Float 14.9 x 24		Maxi-Float 16.9 x 24		11.2 x 38	
	ft/min	M/min	ft/min	M/min	ft/min	M/min	ft/min	M/min	ft/min	M/min
30	6.10	1.86	6.33	1.93	6.77	2.06	7.22	2.20	8.34	2.54
34	6.87	2.09	7.14	2.17	7.75	2.36	8.25	2.51	9.12	2.78
37	7.53	2.30	7.82	2.38	8.53	2.60	8.9	2.71	10.28	3.13
56	11.39	3.47	11.83	3.61	12.63	3.85	13.48	4.11	15.03	4.58
68	13.74	4.19	14.28	4.35	15.49	4.72	16.51	5.03	18.24	5.56

\*\*\* RPM and speed for 480 V, 60 Hz service. For 50 Hz service reduce travel by factor of 0.833.

Example: 30 RPM center drive motor with 14.9 x 24 High Float Tires = 6.77 feet Per Minute (2.06 Meters Per Minute)

3. Determine inches (millimeters) per day the machine will apply.

$$\text{Inches Per Day} = \frac{(\text{GPM}) (735.3 \text{ in})}{(\text{SL})^2}$$

Example:

$$\begin{aligned} \text{Gallons Per Minute} &= 800 \text{ GPM} \\ \text{System Length} &= 1424 \text{ ft} \\ \text{Inches. Per Day} &= \frac{(800 \text{ GPM}) (735.3 \text{ in})}{(1424 \text{ ft})^2} \end{aligned}$$

$$= 0.29 \text{ Inches Per Day}$$

$$\text{Millimeters Per Day} = \frac{(\text{LPS}) (27,488.4 \text{ mm})}{(\text{SL})^2}$$

Example:

$$\begin{aligned} \text{Liters Per Second} &= 50.47 \text{ LPS} \\ \text{System Length} &= 434 \text{ M} \\ \text{Millimeters Per Day} &= \frac{(50.47 \text{ LPS}) (27,488.4 \text{ mm})}{(434 \text{ M})^2} \end{aligned}$$

$$= 7.3 \text{ Millimeters Per Day}$$

4. Determine Hours Per Revolution at 100 Percent Timer Setting.

$$\text{Hours Per Revolution at 100\%} = \frac{(0.105) (\text{DLRDU in feet})}{(\text{Speed in ft/min})} \quad \text{Hours Per Revolution at 100\%} = \frac{(0.105) (\text{DLRDU in Meters})}{(\text{Speed in M/min.})}$$

Example:

$$\begin{aligned} \text{DLRDU} &= 1260 \text{ ft} \\ \text{Speed in Feet Per Minute} &= 6.77 \text{ ft/min} \\ \text{Hours Per Revolution at 100\%} &= \frac{(0.105) (1260 \text{ ft})}{(6.77 \text{ ft})} \end{aligned}$$

$$= 19.5 \text{ Hours Per Revolution at 100\%}$$

Example:

$$\begin{aligned} \text{DLRDU} &= 384 \text{ M} \\ \text{Speed in Meters Per Minute} &= 2.06 \text{ M/min} \\ \text{Hours Per Revolution at 100\%} &= \frac{(0.105) (384 \text{ M})}{(2.06 \text{ M/min})} \end{aligned}$$

$$= 19.5 \text{ Hours Per Revolution at 100\%}$$

5. Determine Inches (millimeters) Per Revolution at 100 Percent Timer Setting.

$$\text{Inches Per Revolution at 100\%} = \frac{(\text{Hours/Revolution}) (\text{In/Day})}{(24)} \quad \text{Millimeters Per Revolution at 100\%} = \frac{(\text{Hours/Revolution}) (\text{mm/Day})}{(24)}$$

Example:

$$\begin{aligned} \text{Hours Per Revolution} &= 19.5 \\ \text{Inches Per Day} &= 0.29 \text{ in} \\ \text{Inches Per Revolution at 100\%} &= \frac{(19.5) (0.29 \text{ in})}{(24)} \end{aligned}$$

$$= 0.24 \text{ Inches Per Revolution at 100\%}$$

Example:

$$\begin{aligned} \text{Hours Per Revolution} &= 19.5 \\ \text{Millimeters Per Day} &= 7.3 \text{ mm} \\ \text{Millimeters Per Revolution at 100\%} &= \frac{(19.5) (7.3 \text{ mm})}{(24)} \end{aligned}$$

$$= 5.9 \text{ Millimeters Per Revolution at 100\%}$$

6. Determine Inches (millimeters) Per Revolution and Hours Per Revolution for any percent timer setting.

$$\text{Inches Per Revolution} = \frac{(\text{Inches/Revolution at 100\%}) (100)}{(\text{Percent Timer Setting})} \quad \text{Millimeters Per Revolution} = \frac{(\text{mm/Revolution at 100\%}) (100)}{(\text{Percent Timer Setting})}$$

Example:

$$\text{Inches Per Revolution at 50\%} = \frac{(0.24 \text{ in}) (100)}{(50)}$$

$$= 0.48 \text{ Inches Per Revolution at 50\%}$$

Example:

$$\text{Millimeters Per Rev. at 50\%} = \frac{(5.9 \text{ mm}) (100)}{(50)}$$

$$= 11.9 \text{ Millimeters Per Revolution at 50\%}$$

$$\text{Hours Per Revolution} = \frac{(\text{Hours/Revolution at 100\%}) (100)}{(\text{Percent Timer Setting})} \quad \text{Hours Per Revolution} = \frac{(\text{Hours/Revolution at 100\%}) (100)}{(\text{Percent Timer Setting})}$$

Example:

$$\text{Hours Per Revolution at 50\%} = \frac{(19.5) (100)}{(50)}$$

$$= 39 \text{ Hours Per Revolution at 50\%}$$

Example:

$$\text{Hours Per Revolution at 50\%} = \frac{(19.5) (100)}{(50)}$$

$$= 39 \text{ Hours Per Revolution at 50\%}$$

# Valley ClassicPlus Control Panel

---

## Operation

### Percent Timer Setting Calculation Worksheet

1. Determine Machine Length.

$$SL = \text{_____ feet}$$

$$SL = \text{_____ Meters}$$

2. Determine the End Tower Rotational Speed at 100% Timer Setting.

$$\text{Speed} = \text{_____ ft/min}$$

$$\text{Speed} = \text{_____ M/min}$$

3. Determine Inches (millimeters) Per Day the machine will apply.

$$\text{Inches Per Day} = \frac{(\text{GPM}) (735.3)}{(\text{SL})^2}$$

$$\text{Millimeters Per Day} = \frac{(\text{LPS}) (735.3)}{(\text{SL})^2}$$

$$= \frac{(\text{_____}) (735.3)}{(\text{_____})^2}$$

$$= \frac{(\text{_____}) (735.3)}{(\text{_____})^2}$$

$$= \frac{(\text{_____})}{(\text{_____})}$$

$$= \frac{(\text{_____})}{(\text{_____})}$$

$$= \text{_____}$$

$$= \text{_____}$$

4. Determine Hours Per Revolution at 100 Percent Timer Setting.

$$\text{Hours Per Revolution at 100\%} = \frac{(0.105) (\text{DLRDU in ft})}{(\text{Speed in ft/min})}$$

$$\text{Hours Per Revolution at 100\%} = \frac{(0.105) (\text{DLRDU in M})}{(\text{Speed in M/min})}$$

$$= \frac{(0.105) (\text{_____})}{(\text{_____})}$$

$$= \frac{(0.105) (\text{_____})}{(\text{_____})}$$

$$= \frac{(\text{_____})}{(\text{_____})}$$

$$= \frac{(\text{_____})}{(\text{_____})}$$

$$= \text{_____}$$

$$= \text{_____}$$

5. Determine Inches (millimeters) Per Revolution at 100 Percent Timer Setting.

$$\text{Inches Per Revolution at 100\%} = \frac{(\text{Hrs/Rev}) (\text{In/Day})}{24}$$

$$\text{Millimeters Per Revolution at 100\%} = \frac{(\text{Hrs/Rev}) (\text{mm/Day})}{24}$$

$$= \frac{(\text{_____}) (\text{_____})}{24}$$

$$= \frac{(\text{_____}) (\text{_____})}{24}$$

$$= \frac{(\text{_____})}{24}$$

$$= \frac{(\text{_____})}{24}$$

$$= \text{_____}$$

$$= \text{_____}$$

# Valley ClassicPlus Control Panel

## Operation

### Percent Timer Setting Calculation Worksheet (Continued)

6. Determine Inches (millimeters) Per Revolution and Hours Per Revolution for any percent timer setting using these two formulas:

Inches (millimeters) Per Revolution =

(Inches(mm)/Revolution at 100%) (100)  
(Percent Timer Setting)

$$= \frac{(\quad)(100)}{(\quad)}$$

$$= \frac{(\quad)}{(\quad)}$$

$$= \underline{\hspace{2cm}}$$

100% = (\_\_\_\_) Inches (millimeters)/Per Revolution

90% = (\_\_\_\_) ÷ (0.90) = \_\_\_\_\_ In (mm)/Rev

80% = (\_\_\_\_) ÷ (0.80) = \_\_\_\_\_ In (mm)/Rev

70% = (\_\_\_\_) ÷ (0.70) = \_\_\_\_\_ In (mm)/Rev

60% = (\_\_\_\_) ÷ (0.60) = \_\_\_\_\_ In (mm)/Rev

50% = (\_\_\_\_) ÷ (0.50) = \_\_\_\_\_ In (mm)/Rev

40% = (\_\_\_\_) ÷ (0.40) = \_\_\_\_\_ In (mm)/Rev

30% = (\_\_\_\_) ÷ (0.30) = \_\_\_\_\_ In (mm)/Rev

25% = (\_\_\_\_) ÷ (0.25) = \_\_\_\_\_ In (mm)/Rev

20% = (\_\_\_\_) ÷ (0.20) = \_\_\_\_\_ In (mm)/Rev

15% = (\_\_\_\_) ÷ (0.15) = \_\_\_\_\_ In (mm)/Rev

10% = (\_\_\_\_) ÷ (0.10) = \_\_\_\_\_ In (mm)/Rev

5% = (\_\_\_\_) ÷ (0.05) = \_\_\_\_\_ In (mm)/Rev

Hours Per Revolution =

(Hours/Revolution at 100%) (100)  
(Percent Timer Setting)

$$= \frac{(\quad)(100)}{(\quad)}$$

$$= \frac{(\quad)}{(\quad)}$$

$$= \underline{\hspace{2cm}}$$

100% = (\_\_\_\_) Hours Per Revolution

90% = (\_\_\_\_) ÷ (0.90) = \_\_\_\_\_ Hrs/Rev

80% = (\_\_\_\_) ÷ (0.80) = \_\_\_\_\_ Hrs/Rev

70% = (\_\_\_\_) ÷ (0.70) = \_\_\_\_\_ Hrs/Rev

60% = (\_\_\_\_) ÷ (0.60) = \_\_\_\_\_ Hrs/Rev

50% = (\_\_\_\_) ÷ (0.50) = \_\_\_\_\_ Hrs/Rev

40% = (\_\_\_\_) ÷ (0.40) = \_\_\_\_\_ Hrs/Rev

30% = (\_\_\_\_) ÷ (0.30) = \_\_\_\_\_ Hrs/Rev

25% = (\_\_\_\_) ÷ (0.25) = \_\_\_\_\_ Hrs/Rev

20% = (\_\_\_\_) ÷ (0.20) = \_\_\_\_\_ Hrs/Rev

15% = (\_\_\_\_) ÷ (0.15) = \_\_\_\_\_ Hrs/Rev

10% = (\_\_\_\_) ÷ (0.10) = \_\_\_\_\_ Hrs/Rev

5% = (\_\_\_\_) ÷ (0.05) = \_\_\_\_\_ Hrs/Rev

# Valley ClassicPlus Control Panel

## Appendix

### Tire Pressure

Proper tire pressure is important! Operating with low tire pressure will damage the tires and drive train. Check tire pressure at least three times a year; at spring start-up, during the irrigation season, and when performing fall winterization. Valmont recommends you check tire pressures monthly during the irrigation season. Refer to the decal on the rim for the proper tire pressure. See Figure 36-1 for recommended tire pressures.

### Replacing Tires

When replacing tires on your system, be sure the ply rating of the new tire is equal to or higher than the ply rating of the old tire. The 11.2-24 four ply Titan tires are specially constructed with a 6-ply bead, and must be replaced with the same Valmont part number (0991257) or with a 6-ply tire.



## WARNING

- TIRES ARE SHIPPED AT A PRESSURE OF 30-35 PSI. BE SURE THE TIRES HAVE BEEN DEFLATED TO THE CORRECT PRESSURE (SHOWN ON THE DECAL) BEFORE THE TIRE IS USED.

**TIRE PRESSURE TABLE**

Span Drive Units			
Tire Size	Pounds per Square Inch	Kilo pascal	Bar
(Inches)	(PSI)	(kPa)	(bar)
11 X 22.5 Tire	34	234	2.3
11.2 X 24 Tire	34	234	2.3
14.9 X 24 Float Tire	18	124	1.2
14.9 X 24 Turf Tire	18*	124	1.2
16.9 X 24 Turf Tire	16	110	1.1
18.4 X 26 Tire	16	110	1.1
11.2 X 38 Tire	23	158	1.5
11L X 15 Implement Tire (4 Wheel E-Z Tow Only)	30	206	2.1

Figure 36-1 \*Tire pressure may be reduced to 16 psi (110 kPa) for increased flotation.