



**Valley Pro2 Control Panel
Owner's Manual**

**For
Software Version 9.02
0998943_C**

Table of Contents

EC Declaration of Conformity	7
Electrical Safety Statement	8
About This Manual	8
Ancillary Equipment Warranty	8
Safety	9
Recognize Safety Information.....	9
Safety Messages.....	9
Information Messages.....	9
Use of Personal Protective Equipment	10
Conductive Materials and Equipment	10
Fall Protection	10
Minimum Working Clearance	11
Qualified Person.....	11
Overhead Power Lines.....	12
Minimal Lockout / Tagout Procedure	13
Sequence of Lockout.....	13
Restoring Equipment to Service.....	13
Operate Safely	15
Safety Decals.....	19
Overview	23
Control Panel	23
Main Disconnect.....	23
Safety Override Switch.....	23
Three-Second Delay Timer	23
Pump Restart Delay	23
Control Panel Display.....	24
Function Keys.....	26
Numeric Entry Keys.....	27
Command Selection Keys	28
Symbols and Conventions	29
Command Prompt	29
Exiting Screens	29
Screen Delays	29
Illustrations	29
Control Panel Setup	31
Minimum Control Panel Setup	33
Set Position (No GPS).....	34
Set GPS Position and Fallback Run Time Manual Method (Machines with GPS).....	35
Setup GPS Position Loss	37
Test and Adjust the GPS Position.....	39
Voltage	40
Low Voltage.....	40
Estimated Drive Unit Speed Table	40
GPS Angular Conversion Table.....	41
Angular Degree Examples	41
System Constants Record	42
Operation	45
Run the Machine Wet (With Water).....	45
Run the Machine Dry (Without Water)	45
Stopping the Machine	46
Emergency Stopping.....	46
Stopping Under Normal Conditions.....	46

Table of Contents

Diagnostics	47
Diagnostics Screen	47
System Faults	47
Viewing System Faults	48
Status Screen Diagnostics.....	48
Clearing an Error Code	48
Error Codes.....	49
Error Logs	50
Viewing an Error Log.....	50
Resetting an Error Log to Zero.....	50
Troubleshooting.....	51
System Faults	52
Error Codes.....	54
Error Codes.....	54
Troubleshooting List.....	57
Hard Reset.....	59
Executing a Hard Reset	59
Advanced Features	61

To Run The Machine: (Refer to the Overview and Operation sections of the Owner's Manual, and to the Advanced Features Manual.)

1. ALWAYS make sure that vehicles, other equipment, livestock, and people are clear of the machine before operating.
2. Turn the control panel main disconnect switch to the ON position. If the power is supplied by an engine driven generator, adjust the RPM of the generator until the voltmeter reads 460 – 505 volts. DO NOT EXCEED 505 VOLTS.

Run The Machine Wet (With Water)

3. Press **WATER ON**.
4. Select direction of travel by pressing **FORWARD** or **REVERSE**.
5. Set the water application by pressing **DEPTH** or **PERCENT**.
 - Use **DEPTH** to set water application by inches(mm) of water.
 - Use **PERCENT** to set water application by percent timer setting.
6. Use the numeric keys to enter the depth of water in inches (mm) or the percent timer setting.

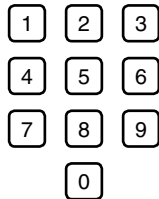

7. Press **ENTER** to retain value.
8. Press **START** to start the machine.
9. Press **STOP** to stop the machine.

Controlling Auxiliary Relays:

1. Press **OPTIONS**.
2. Press **1** for AUX1 or **2** for AUX2.
3. Press **1** for ON or **0** for OFF.

Selecting Stop-In-Slot On/Off:

1. Press **SIS ON** to enable the stop-in-slot.
2. Press **SIS OFF** to bypass the stop-in-slot location.

To Set The Stop-In-Slot Position:

1. Press **SYSTEM**.
2. Press **1** for CONSTANTS.
3. Press **3** for Stop-In-Slot.
4. Enter the desired stop-in-slot position in degrees and press **ENTER**.

Turning Power And Pressure Restart On:

1. Press **OPTIONS**.
2. Press **7** for AUTORESTART.
3. Press **1** for ON or **0** for OFF.
4. Press **2** for PRESSURE, **1** for POWER, or **0** for BOTH.

NOTE: This option requires a Start\$ be entered. Refer to the section in the Advanced Features Manual entitled "Automatic Restart Option" for more information.

Selecting Auto Reverse Or Auto Stop:

1. Press **OPTIONS**.
2. Press **6** for AUTOREVERSE.
3. Press **1** for AUTO REVERSE or **0** for AUTO STOP.

NOTE: Only applicable with drive unit mounted end-of-field stop/auto reverse hardware. ARAS must be ON.

To turn ARAS ON press **SYSTEM**, **1**, **8**, **8**, **2**, **1**.

Run The Machine Dry (Without Water)

3. Press **WATER OFF**.
4. Select direction of travel by pressing **FORWARD** or **REVERSE**.
5. Set the speed of travel by pressing **PERCENT**.
6. Use the numeric keys to enter percent timer setting.

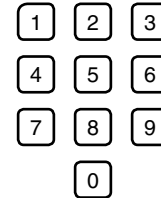

7. Press **ENTER** to retain value.
8. Press **START** to start the machine.
9. Press **STOP** to stop the machine.

Setting The End Gun:

Refer to Figure 1.

1. Press **SYSTEM**.
2. Press **1** for CONSTANTS.
3. Press **4** for End Gun.
4. Select the sequence (#1-9) that you wish to work with.
5. Enter the left angle (end gun ON) in degrees and press **ENTER**.
6. Enter the right angle (end gun OFF) in degrees and press **ENTER**.
7. Select another sequence or press **ESC** to exit.

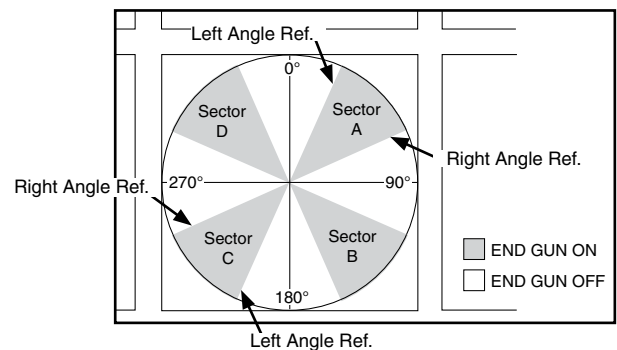

SECTOR A		SECTOR B		SECTOR C		SECTOR D	
LEFT ANGLE	RIGHT ANGLE	LEFT ANGLE	RIGHT ANGLE	LEFT ANGLE	RIGHT ANGLE	LEFT ANGLE	RIGHT ANGLE
31	59	121	149	211	239	301	329

Figure 1

Quick Reference Guide

System Faults & Descriptions

FAULT	DESCRIPTION
SYSTEM POWER FAULT	Voltage has fallen below the low voltage limit for more than 15 seconds, or power was lost while the machine was running.
SYSTEM SAFETY FAULT	Caused by a break in the safety return circuit that lasted longer than three seconds.
LOW PRESSURE FAULT	The pressure fell below the low pressure limit, or the Pressure Delay is not a sufficient amount of time to build pressure in the machine after it is started.
HIGH PRESSURE FAULT	With VRI-Zone on, the pressure went above the high pressure limit for more than three seconds.
WATER TIMER FAULT	The machine shut down because it was moving too slowly, thereby applying too much water.
COMMAND FAULT	The machine was commanded to stop by one of the following: 1) The STOP key was pressed. 2) An autostop condition occurred at the end-of-field stop. 3) A programmed STOP command was executed.
STOP-IN-SLOT (SIS) FAULT	The machine was shut down by the Stop-In-Slot.
PROGRAM FAULT	The machine was shut down because a Step program stopped the system.
AUTOSTOP FAULT	An autostop condition occurred at the end-of-field stop.
BBRAM FAULT	An attempt was made to start the machine when error E01 was displayed on the status screen.
FLOW FAULT	With VRI-Z on, the flow rate has fallen below the amount set in the FLOWMETER GAL/PULSE field.
FOR/REV FAULT	Both the forward and reverse sensor relays were on for more than 15 seconds while the system was running or waiting.
TIRE PRESSURE	Tire pressure shutdown was turned on and one or more tires had low pressure.
WIND FAULT	The machine shut down because the wind speed reached the high wind limit. The wind speed indicator is an option. WIND is only displayed on the system faults screen when wind is turned ON.
TEMPERATURE FAULT	The machine shut down because the temperature fell below the low temperature limit.
RAIN FAULT	The machine shut down because the rain limit was exceeded in the rain window time period.
DAILY OPS FAULT	The daily operations program shut the machine down because it is not allowed to run between a certain time period, DAILY OPS is only displayed on the system faults screen when Daily Ops is turned ON.
NO ACK	No Acknowledge is enabled and the BaseStation did not acknowledge the message.
RELAY COM FAULT	There is a hardware or software communication problem between the Pro2 module and the electrical relay board within the control panel.
GPS COM FAULT	When GPS is selected as a protocol and the system shuts down due to no communication with GPS for a user-specified amount of time, when shut down of GPS signal loss is ON, or while the system was running or waiting.
GPS LOCK FAULT	When GPS is selected as a protocol and the System shuts down due to GPS signal loss for a user-specified amount of time, or when shut down of GPS signal loss is ON, or while the system is running or waiting.
BOUNDARY FAULT	The machine shut down because it traveled beyond the forward or reverse Position angles.

Error Codes & Descriptions

ERROR	DESCRIPTION	ERROR	DESCRIPTION
E01	BBRAM - Checksum failed at power up.	E15	UNDERWATER ERROR - Check for induced voltages and % timer connections.
E02	EEPROM - Checksum failed at power up.	E16	NOT AVAILABLE
E03	UNIT RESETS - This is logged when the software resets.	E17	NOT AVAILABLE
E04	POWER DROP - Power dropped below low voltage limit.	E18	GPS communications error, check GPS connection and power.
E05	SYSTEM SAFETY - Possible tower misalignment, drive unit may be stuck.	E19	GPS SIGNAL LOSS, check for clear path above antenna.
E06	PUMP SAFETY - Pressure too low after pressure delay.	E20	DGPS SIGNAL LOSS, check for clear path above antenna.
E07	PRESSURE SENSOR - Out of range high, check connection.	E21	LOW FLOW
E08	PRESSURE SENSOR - Out of range low, check connection.	E22	HIGH PRESSURE
E09	PRESSURE SENSOR - Pressure high with pump off, check connection.	E23	PLC COMMUNICATIONS ERROR. (GPS V2 Only)
E10	PRESSURE SENSOR - Mechanical switch could be stuck.	E24	RESYNC valve duty cycle due to pressure.
E11	RESOLVER - Angle jumping around. Lube J pipe.	E25	GPS COORDINATES OUT OF RANGE, check distance to GPS or for crosstalk.
E12	E12 RESOLVER - Out of range high, check for loose or shorted wires.	E26	LOW TIRE PRESSURE
E13	KEYPAD - Possible key stuck, check keypad connection.	E27	TPMS COMMUNICATIONS ERROR
E14	FWD/REV SENSE - Possible short, check wiring.		

EC Declaration of Conformity



We: **Valmont Industries, Inc.**
28800 Ida Street
Valley, NE 68064
+1 402.359.6312
+1 402.359.6143 (Facsimile)

Serial Number:

Purchase Order:

declare under our sole responsibility that the product,

Crop Irrigation System

to which this documentation relates, is in conformity with the following documents:

Machinery Directive 2006/42/EC
Low Voltage Directive 2006/95/EC
Electromagnetic Compatibility Directive 2004/108/EC

The above-referenced equipment is in conformity with all safety-related clauses (Not all clauses reflecting commercial preference are met) of the following documents:

EN 60204-1:2006 Safety of Machinery – Electrical Equipment of Machines
EN 12100:2010 Safety of Machinery
EN 909:1998+A1 Irrigation Machines

Statement regarding **Pressure Equipment Directive 97/23/EC:**

The Crop Irrigation System is excluded from the scope of the Pressure Equipment Directive, by the language of Article 1, Sections 3.2, 3.6 & 3.10. This equipment is classified less than Category 1.

Statement regarding **RoHS Directive 2011/65/EC:**

The Crop Irrigation System is excluded from the scope of the RoHS Directive, by the language of Article 2, Section 4(e), being a "Large Scale Fixed Installation."

Person Authorized to Compile the Technical File in Europe:
Relevant information will be transmitted via e-mail
in response to a reasoned request by national authorities

Philipp Schmidt-Holzmann
Valmont S.A.U.
28840 Mejorada del Campo
Madrid, ES 28840
+34 91 679 4300

Ron Pollak
Senior Electrical Engineer
Valmont Industries, Inc.

Date of Issue: March 9, 2015
Place of Issue: Valley, NE 68064

Electrical Safety Statement

Installation Of The Valley Electric Irrigation Machine - European Union Only

Valmont Industries Inc. does not install a differential (ground fault) circuit breaker in the control panel of the Valley electric irrigation machine because the standards of protection vary according to country of destination. The distributor must provide and install a differential (ground fault) circuit breaker that meets the standards of the country where the Valley irrigation machine is installed.

In the European Union, differential circuit breaker protection is fixed at a maximum of 24 volts.

Good grounding of the Valley irrigation machine is required.

- If resistance to ground is lower than 80 ohms, a differential (ground fault) circuit breaker of 300 mA will meet requirements.
- If resistance to ground is between 80 and 800 ohms, a differential (ground fault) circuit breaker of 30 mA will meet requirements.

The power supply installation and inspection of equipment protection components or machines are the responsibility of the installer. Valmont Industries Inc. is not responsible for the failure of equipment protection components or machines not of their manufacture.

Valley pivot irrigation machines receiving power from a generator must have a cable connected from the irrigation machine structure to a ground rod and another cable from the irrigation machine structure to the ground terminal on generator in order for the differential (ground fault) circuit breaker to work.

- The resistance between the irrigation machine and the generator must be substantially below 80 ohms.

About This Manual

Information contained in this manual applies to all Valley Pro2 Control Panels with software version 9.02. Sections related to safety, pivot hardware, maintenance, towing, troubleshooting and winterization are covered in the appropriate Valley Pivot Owners Manual.

You, as the owner/operator, should familiarize yourself with the capabilities of the system in order to obtain optimum system performance. It should be remembered that the sprinkler will perform according to your knowledge of the equipment, soil and water relationships and equipment application concepts.

Specifications, descriptions and illustrative material contained herein were as accurate as known at the time this publication was approved for printing.

Valmont Industries Inc., reserves the right to change specification or design without incurring obligation. Specifications are applicable to machines sold in the United States and may vary outside the United States.

Additional information is contained within the Valley Pro2 Control Panel Advanced Features Manual, Part Number 0998944 (English).

Ancillary Equipment Warranty

The owner is responsible for warranty registration of all ancillary equipment such as engines, pumps and generators with its respective manufacturer.

Recognize Safety Information

This irrigation equipment can be powered by high voltage, which can be extremely dangerous if used improperly. For maximum safety and optimum performance of the machine, all owner/operators and maintenance personnel must read and understand the owner/operator manual(s), all safety messages in this manual and safety signs/decals on the machine before operating this equipment.

Anyone assembling, operating, servicing or maintaining this machine must read and understand all operation, maintenance, troubleshooting, testing, installation, assembly instructions and all safety messages in this manual before operating the machine or beginning any maintenance, troubleshooting, testing, installation or assembly of components.

These instructions alert you to certain things you should do carefully; if you don't, you could hurt yourself or others, hurt the next person who operates the equipment, or damage the equipment.

Safety Messages

Safety messages in this manual are preceded by the hazard symbol and one of three words: DANGER, WARNING or CAUTION. These messages alert you to potential hazards that could hurt you or others and or cause property damage.



This HAZARD SYMBOL is used to alert you to information about unsafe actions or situations, and may be followed by the word DANGER, WARNING or CAUTION.

DANGER

The HAZARD SYMBOL used with the word DANGER describes immediate hazards that can result in severe personal injury or death.

WARNING

The HAZARD SYMBOL used with the word WARNING describes unsafe actions or situations that can result in severe injury, death and/or major equipment or property damage.

CAUTION

The HAZARD SYMBOL used with the word CAUTION describes unsafe actions or situations that can result in injury, and/or minor equipment or property damage.

Information Messages

Important information messages in this manual are preceded by the word NOTE.

NOTE

The word NOTE is used to alert you to information that describes procedures or tips to help you install, operate or maintain your equipment properly.

Safety

Use of Personal Protective Equipment

- People working in areas where there are potential electrical hazards must use, personal protective equipment that is appropriate for the specific parts of the body to be protected and for the work to be performed. Refer to U.S. Occupational Safety & Health Administration (OSHA) Regulations (Standards - 29 CFR) Safeguards for personnel protection. - 1910.335, or applicable national, state or local regulations, for additional information.
- Personal protective equipment must be maintained in a safe, reliable condition and periodically inspected or tested.
- Protective shields, protective barriers, or insulating materials must be used to protect each person from shock, burns, or other electrically-related injuries while that person is working near exposed energized parts which might be accidentally contacted or where dangerous electric heating or arcing might occur. When normally enclosed live parts are exposed for maintenance or repair, they must be guarded to protect unqualified persons from contact with the live parts.
- Safety signs and tags. Safety signs, safety symbols, or accident prevention tags must be used where necessary to warn people about electrical hazards which may endanger them.

Conductive Materials and Equipment

Materials and equipment that can conduct electricity must be handled in a way that will prevent them from contacting energized power lines, exposed conductors or circuit parts.

- When handling long conductive objects (such as but not limited to truss rods, pipes, angles and ladders) in areas with energized power lines, exposed conductors or circuit parts, work practices (such as the use of insulation, guarding, and material handling techniques) must be used to minimize the hazard.
- Portable ladders must have non-conductive side rails.
- Do not wear conductive articles of jewelry and clothing (such as but not limited to watch bands, bracelets, rings, key chains, necklaces, metalized aprons, cloth with conductive thread, or metal headgear) that could come in contact with energized power lines, exposed conductors or circuit parts.

Fall Protection

Identify potential fall hazards and determine if fall protection equipment is appropriate for the task, before beginning the work. Pay attention to hazards associated with routine and non-routine tasks. Inspect fall protection equipment (harnesses, lanyards) and devices (guardrails, tie-off points) before each use. Use fall protection equipment if required for the job. Be sure the fall protection equipment is right for the task, fits properly, and is in good condition. Refer to U.S. Occupational Safety & Health Administration (OSHA) Regulations Standards - 29 CFR 1926.500, 1926.501 and 1926.502, or applicable national, state or local regulations for more information.

- When using scaffolds, make sure there is proper access, full planking, stable footing, and guard railing.
- When using a boom lift, keep feet firmly on the platform of a boom lift, use fall protection equipment tied-off at all times to the guardrail or tie-off point.
- When using a ladder, make sure the ladder is non-conductive and the correct size for the task. Read the ladder user instructions and be sure the ladder is in good condition. Make sure ladder is set on stable footing and at the correct angle.

Minimum Working Clearance

To reduce the risk of injury, all persons require adequate working clearance around the electrical panel or other electrical equipment. The table below identifies the minimum working clearance needed. Refer to U.S. Occupational Safety & Health Administration (OSHA) Regulations (Standards - 29 CFR) Safeguards for personnel protection. -1910.303(g)(1)(i), or any other applicable national, state or local regulations, for additional information.

MINIMUM WORKING CLEARANCE 0-600 VOLTS				
WIDTH OF WORKING CLEARANCE AREA	HEIGHT OF WORKING CLEARANCE AREA	★ MINIMUM WORKING CLEARANCE IN FRONT OF ELECTRICAL PANEL/EQUIPMENT		
		EXPOSED LIVE PARTS ON ONE SIDE OF WORK SPACE AND NO LIVE GROUNDED PARTS ON THE OTHER SIDE.	EXPOSED LIVE PARTS ON ONE SIDE OF WORK SPACE AND LIVE GROUNDED PARTS ON THE OTHER SIDE.	EXPOSED LIVE PARTS ON ONE SIDE OF WORK SPACE AND EXPOSED LIVE PARTS ON THE OTHER SIDE.
30in.(760mm) MINIMUM OR WIDTH OF ENCLOSURE, WHICH EVER IS GREATER	78in.(1980mm) MINIMUM OR HEIGHT OF ENCLOSURE, WHICH EVER IS GREATER	36in.(915mm) MINIMUM	42in.(1065mm) MINIMUM	48in.(1220mm) MINIMUM

★Concrete, brick or tile walls shall be considered as grounded.

Qualified Person

A Qualified Person is one who, by possession of a recognized degree, certificate, or professional standing, or who by extensive knowledge, training, and experience, has successfully demonstrated his/her ability to solve or resolve problems related to the subject matter, the work, or the project.

Only qualified persons may work on electric circuit parts or equipment that have not been de-energized.

Refer to U.S. Occupational Safety & Health Administration (OSHA) Regulations Standards - 29 CFR 1926.32(m) and 1910.333, or applicable national, state or local regulations for additional information.

Safety

Overhead Power Lines

Assembling, towing or transporting irrigation machine components such as but not limited to the pivot point, linear cart, span/drive unit assemblies, overhangs and/or corner assemblies underneath or near power lines is extremely dangerous because of the risk of electrocution.

Operating equipment that elevates irrigation machine components, such as but not limited to an aerial lift or crane, near power lines is extremely dangerous because of the risk of electrocution. Only qualified personnel should operate this type of equipment. Before operating the equipment, qualified personnel must read the equipment manufacturers' operating and safety instructions.

Refer to U.S. Occupational Safety & Health Administration (OSHA) Regulations (Standards - 29 CFR) Cranes and derricks. - 1926.550, or any other applicable national, state or local regulations for additional information.

- Always presume that any overhead power line is an energized line unless and until the person(s) owning the line and/or the electrical utility authorities indicate that it is not an energized line and it has been visibly grounded.
- Before operating any equipment near any power line make sure the line has been de-energized and visibly grounded at the point of work.
- Electrocution can occur without touching an electrical power line. Electricity, depending on the magnitude, can jump or become induced into equipment or conductive materials that come in close proximity to, but do not touch a power line. High wind, lightning, wet ground and other environmental conditions will increase the possibility of electrocution and require additional consideration.
- Transmitter towers can induce the equipment or materials being handled with an electrical charge. Before working or operating equipment near transmitter towers, make sure the transmitter is de-energized.
- Select the location where the span/drive unit will be assembled to ensure that neither the irrigation machine, or the equipment used during the assembly process, will violate the minimum clearance guidelines.
- Never operate equipment or allow the load, ropes or tag lines within 10 ft (3.05 m) of any power line rated 50 kV or lower whether it is energized or not. For lines rated over 50 kV, the minimum clearance shall be 10 ft (3.05 m) plus 0.4 inch (1.1 cm) for each kV over 50 kVs.
- Never assemble, tow, transport or allow irrigation machine components underneath or within 10 ft (3.05 m) of any power line rated 50 kV or lower whether it is energized or not. For lines rated over 50 kV, the minimum clearance shall be 10 ft (3.05 m) plus 0.4 inch (1.1 cm) for each kV over 50 kVs. Overhang support angles, cables and spinner drive components regularly extend 10 ft to 12 ft (3.1 m to 3.7 m) above the irrigation pipeline (span).
- Use barricades to identify areas where interference with overhead power lines could occur. Keep the assembly, towing or transporting of irrigation machine components and the operation of equipment including load, ropes or tag lines away from any power line, in the distances described above, whether the line is energized or not.
- Always designate a person to observe clearance between the power line and all equipment being operated or moved in order to give timely warning for all operations to STOP if the minimum clearance is violated.

Minimal Lockout / Tagout Procedure

The following procedure establishes the minimum requirements for the lockout of energy isolating devices whenever maintenance or servicing is done on machines or equipment. It is used to ensure that the machine or equipment is stopped, isolated from all potentially hazardous energy sources and locked out before personnel perform any servicing or maintenance where the unexpectedly energized or start-up of the machine or equipment or release of stored energy could cause injury. All personnel, upon observing a machine or piece of equipment which is locked out to perform servicing or maintenance shall not attempt to start, energize, or use that machine or equipment.

When the energy isolating devices are not lockable, tagout should be used and affected personnel must wear full personal protection.

Refer to U.S. Occupational Safety & Health Administration (OSHA) Regulations (Standards - 29 CFR) Typical minimal lockout procedures - 1910.147 App A, or applicable national, state or local regulations, for additional information.

Sequence of Lockout

1. Notify all affected personnel that servicing or maintenance is required on a machine or equipment and that the machine or equipment must be shut down and locked out to perform the servicing or maintenance.
2. The authorized personnel shall identify the type and magnitude of the energy that the machine or equipment utilizes, shall understand the hazards of the energy, and shall know the methods to control the energy.
3. If the machine or equipment is operating, shut it down by the normal stopping procedure (depress the stop button, open switch, close valve, etc.).
4. De-activate the energy isolating device(s) so that the machine or equipment is isolated from the energy source(s).
5. Lock out the energy isolating device(s) with assigned individual lock(s).
6. Stored or residual energy (such as that in capacitors, springs, elevated machine members, rotating fly-wheels, hydraulic systems, and air, gas, steam, or water pressure, etc.) must be dissipated or restrained by methods such as grounding, repositioning, blocking, bleeding down, etc.
7. Ensure that the equipment is disconnected from the energy source(s) by first checking that no personnel are exposed, then verify the isolation of the equipment by operating the push button or other normal operating control(s) or by testing to make certain the equipment will not operate. CAUTION: Return operating control(s) to neutral or "off" position after verifying the isolation of the equipment.
8. The machine or equipment is now locked out.

DANGER

•WHEN PERSONNEL WILL BE EXPOSED TO CIRCUIT ELEMENTS AND ELECTRICAL PARTS, A QUALIFIED PERSON MUST USE TEST EQUIPMENT TO VERIFY THAT THE CIRCUIT ELEMENTS AND EQUIPMENT PARTS OF THE EQUIPMENT ARE DE-ENERGIZED.

Restoring Equipment to Service

When the servicing or maintenance is completed and the machine or equipment is ready to return to normal operating condition, the following steps shall be taken:

1. Check the machine or equipment and the immediate area around the machine to ensure that non-essential items are removed and that the machine or equipment components are operationally intact.
2. Check the work area to ensure that all personnel are safely positioned or removed from the area.
3. Verify that the controls are in neutral.
4. Remove the lockout devices and re-energize the machine or equipment.
5. Notify affected personnel that the servicing or maintenance is completed and the machine or equipment is ready to be used.

Safety

Operate Safely

Valley Irrigation machines are designed with safety in mind. However, if this machine is operated incorrectly, it may pose a safety threat to the operator. A good safety program is much like a chain, it is only as strong as its weakest link. The manufacturer, dealer, and operator must maintain and improve all safety programs. Following is a list of safety operating tips which you and all other persons servicing or operating the machine must read and understand:

CAUTION

- **DO NOT OPERATE THIS MACHINE WITHOUT FIRST READING THE OWNER'S MANUALS FOR THE MACHINE.**
- **READ ALL SAFETY MESSAGES IN THIS MANUAL AND SAFETY SIGNS ON THE MACHINE.**
- **DO NOT LET ANYONE OPERATE THIS MACHINE WITHOUT PROPER INSTRUCTIONS.**
- **UNAUTHORIZED MODIFICATIONS MAY IMPAIR THE FUNCTION AND/OR SAFETY OF THE MACHINE.**
- **IF YOU DO NOT UNDERSTAND ANY PART OF THIS MANUAL, CONTACT YOUR VALLEY DEALER.**

EMPLOYEE INSTRUCTION ON SAFETY

It is very important to instruct your employees on the safe use of this equipment at the time of their initial assignment to operate it. **DO NOT** let anyone operate this equipment without proper instructions.

Safety training should be presented annually and the service manager should ensure employees fully understand the safety messages and what to do in case of emergencies.

EMERGENCY STOPPING

The machine can be stopped at any time at any tower by turning the disconnect switch, located underneath the tower box, to the OFF position. Refer to Figure 15-1.

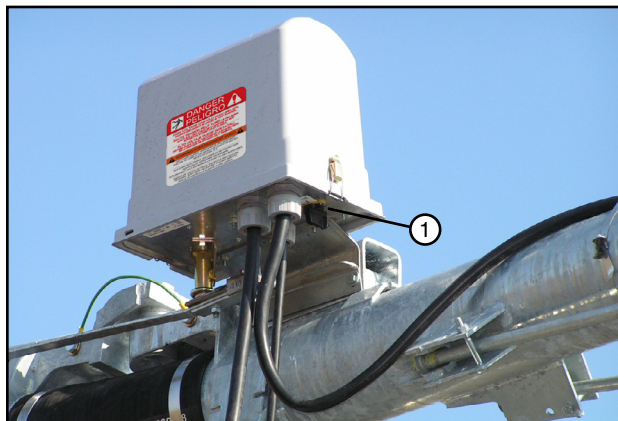

Figure 15-1 1. Disconnect Switch

WARNING

PROPER GROUNDING

DO NOT attempt to start the machine until the electrical service is properly installed and grounded by a qualified electrician as per the electrical standards. Refer to Figure 15-2.

If the power supplied to the machine is not grounded properly, severe injury, or death can result should an electrical malfunction occur.

It is your responsibility to ensure that your power supplier and/or electrical contractor has grounded the irrigation machine as required by the National Electrical Code and by applicable local electrical codes. If a machine is properly grounded and fuse sizing is correct, there is extremely low probability of an individual being injured by electrical shock.

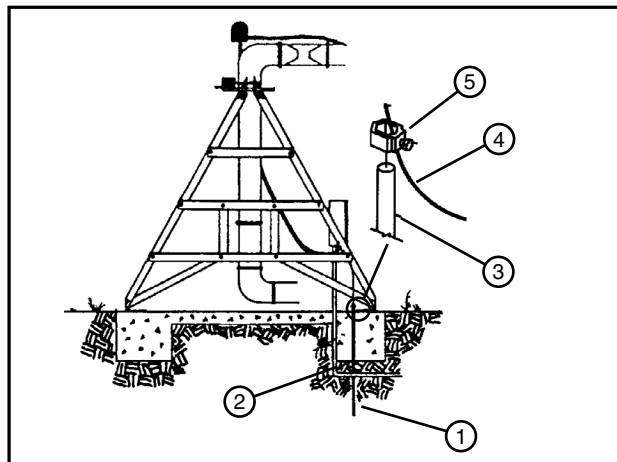

Figure 15-2 1. Ground Rod Installation 4. Copper Ground Wire
2. Service Conductor 5. Clamp
3. Copper Ground Rod

NOTE

- **All 480 VAC, 60 Hz. (380 VAC, 50 Hz.) power supply services MUST be a 4 conductor service. Three 480 VAC (380 VAC) power lines and one ground conductor which is as large as the power carrying conductors for that service.**
- **Each time a towable machine is moved, the ground wire MUST be reattached to the ground rod and checked for electrical integrity before restarting the machine.**

Safety

Operate Safely (Continued)

DANGER

DISCONNECT POWER WHEN SERVICING
ALWAYS disconnect electrical power before servicing or performing maintenance to the machine.

If you are going to perform maintenance on the machine, **YOU MUST** shut off and lock the main power disconnect as shown below. Refer to Figure 16-1.

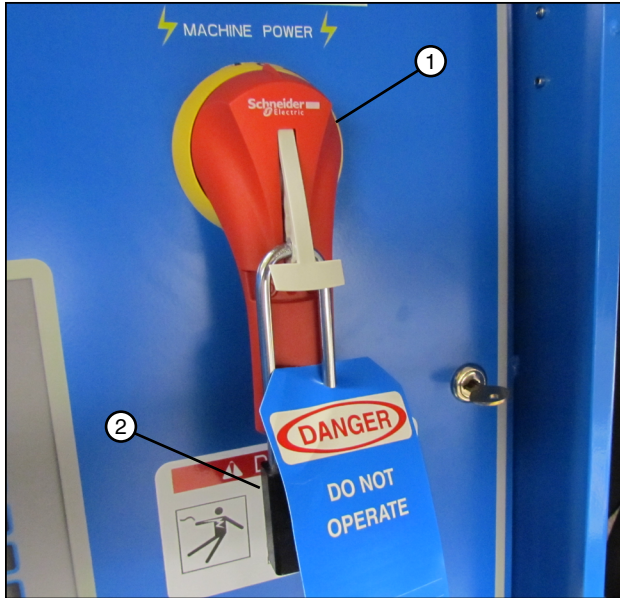

Figure 16-1 1. Main Power Disconnect
2. Lock

The blue (OSHA safety color code) tag shown below should also be filled out and attached to the disconnect after locking. Refer to Figure 16-2.

The tag should reveal the name of a person to contact before restoring power to the machine.



Figure 16-2

CAUTION

QUALIFIED SERVICE PERSONNEL
If you do not understand electricity or other parts of the machine, have qualified service personnel perform any hazardous repairs or maintenance.

CAUTION

GUARD ALL POWER TAKE-OFF DRIVES
This includes all belt and power line drives.
Replace any guards and shields removed for maintenance.

WARNING

MARK AND GUARD ALL POWER LINES
Do NOT deep rip or chisel near the buried power service wires.

Do NOT deep rip in a circle at the drive unit. The deep chisel track will cause severe stresses on the structure.

If you do deep rip your field, run the machine with the percent timer at 100% for the first revolution.

WARNING

SUSPECTED SHORT CIRCUITS
DO NOT touch the machine if you suspect a short-circuit situation. Call a qualified electrician or an authorized Valley dealer immediately.

Circumstances which may cause you to suspect hazardous voltage situations may include:

- Physical damage to the machine or span cable
- Recent electrical storms (lightning)
- Unusual operating characteristics of the machine

If you suspect a short circuit due to feeling a rippling tingle when touching the machine, DO NOT touch the machine again. Call a qualified electrician or an authorized Valley dealer immediately.

Operate Safely (Continued)

WARNING

LIGHTNING AND THE MACHINE

Stay away from the machine during an electrical storm. An irrigation machine makes a good path to earth. It is also probably the tallest object in the field, which makes it a good lightning receptor!

CAUTION

DO NOT OVERSIZE FUSES

Fuses are sized for the protection of a specific machine.

Be certain you have the proper fuse sizes in place before initial start-up and when replacing fuses.

CAUTION

PLUG - IN CONNECTORS

Disconnect power before connecting or disconnecting any plug-in connectors.

CAUTION

DO NOT OPERATE AT FREEZING TEMPERATURES

Spraying water has a cooling effect and water will freeze even though the air temperature is slightly above freezing.

Shut the machine down at 40 degrees Fahrenheit (4.5 degrees Celsius). Do not operate machine when temperature is below 40° F (4.5° C).

•**DAMAGE TO EQUIPMENT RESULTING FROM FREEZE-UP IS NOT COVERED UNDER WARRANTY.**

•**IT IS IMPORTANT TO MAKE SURE ALL PIPE DRAINS FUNCTION PROPERLY TO PREVENT PIPELINE FREEZE-UP DURING COLD WEATHER.**

CAUTION

AVOID HIGH PRESSURE WATER STREAMS

Avoid body contact with high pressure water streams.

WARNING

AVOID CHEMICALS

Avoid exposure to sprinkler spray while chemicals are being injected into the water. Read EPA Label Improvement Program (PR Notice 87-1) and all instructions for chemical applications.

If you plan on chemigating, make certain you have complied with state or local regulations in regard to safety equipment, certification, operation and calibration of the injector pump. Make certain you have first aid and fresh water available in case of an accident. You must also be familiar with the correct cleanup procedures in case of a spill.

•**USE OF PROTECTIVE CLOTHING IS RECOMMENDED WHEN HANDLING CHEMICALS. SAFETY GLASSES, GLOVES, AND PROTECTIVE OUTERWEAR SHOULD BE WORN WHEN HANDLING CHEMICALS.**

•**CONTAMINATION OF THE WATER SUPPLY MAY OCCUR IF EFFECTIVE SAFETY DEVICES ARE NOT INSTALLED/USED IN CONNECTION WITH INJECTION EQUIPMENT FOR CHEMIGATION.**

DANGER

DRIVE SHAFTS START WITHOUT WARNING

An electric motor on each tower of the center pivot powers two or more drive shafts connected to wheel gear drives. These drive shafts start and stop without warning.

•**DO NOT TOUCH ROTATING DRIVE SHAFT OR SHIELD, CLOTHING OR LIMBS MAY BECOME ENTANGLED, RESULTING IN SEVERE INJURY.**

•**DO NOT SERVICE THE MACHINE UNTIL THE MAIN DISCONNECT IS LOCKED IN THE OFF POSITION.**

•**ALWAYS REPLACE DRIVE SHAFT SHIELDS AFTER SERVICING.**

•**DRIVE SHAFT SHIELDS MUST ALWAYS BE IN PLACE WHEN OPERATING THE MACHINE.**

Safety

Operate Safely (Continued)

CAUTION

CHECK WHEEL TRACKS BEFORE STARTING

Make sure all objects, livestock or persons are clear of the machine before starting. Drive trains are powerful and can climb over vehicles, equipment, etc.

CAUTION

KEEP CHILDREN AWAY

Pivots are NOT playground equipment.

Prevent children from playing or climbing around on the machine. This can be extremely dangerous, especially if the machine is operating.

CAUTION

CHECK MACHINE DIRECTION

DO NOT operate the machine if it moves in the direction opposite to that which was chosen.

Forward should be clockwise, and reverse should be counter-clockwise.

CAUTION

KEEP WATER OFF ROADWAYS

It is against the law in most states to allow water to spray on state and county roadways. This is a serious hazard to passing motorists.

If end guns are used, make sure you read and understand the correct procedures for setting the on and off positions to avoid watering the roadways.

If an end gun is watering a roadway, immediately discontinue use and adjust the shutoff setting or call your Valley dealer to repair the end gun shut off mechanism.

CAUTION

PART CIRCLE OPERATION SAFETY

If the machine reverses direction at a roadway or a physical object such as a building, tree line, power pole, etc., then you **MUST** provide a backup device to stop the machine if the reversing mechanism were to fail. Refer to Figure 18-1.

Contact your Valley dealer for more information concerning physical barricades for machines under these circumstances.



Figure 18-1 1. Physical Barricade

CAUTION

PROPER USE OF THE SAFETY OVERRIDE

Caution **MUST** be taken by the operator when using the safety override function as it will bypass or disable all of the machine's automatic safety shutdown circuits.

- **NEVER DEPRESS AND HOLD THE START/STOP SAFETY OVERRIDE SWITCH IN THE START POSITION FOR MORE THAN 3 TO 5 SECONDS.**

If the machine is not in full view by the operator, do not use the Safety Override function.

The operator **MUST** inspect the entire machine between each safety override start attempt.

Repeated safety override start attempts can cause severe structural damage.

Call your Valley dealer if the machine fails to start.

Safety Decals

These Danger, Warning, and Caution decals appear in various locations on a Valley irrigation machine. You **MUST** familiarize yourself and other operator's with these safety decals. For replacement of any decal, contact your local Valley dealer.

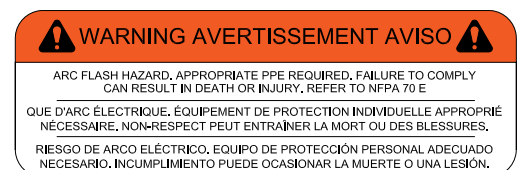
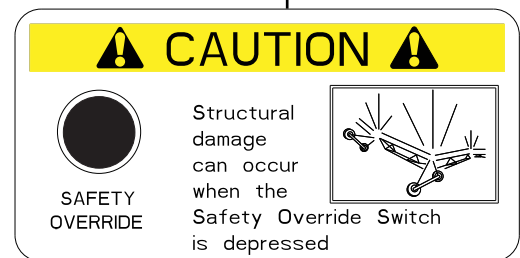
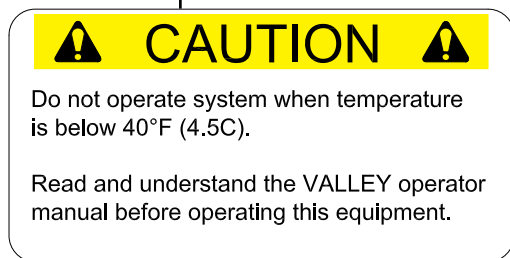
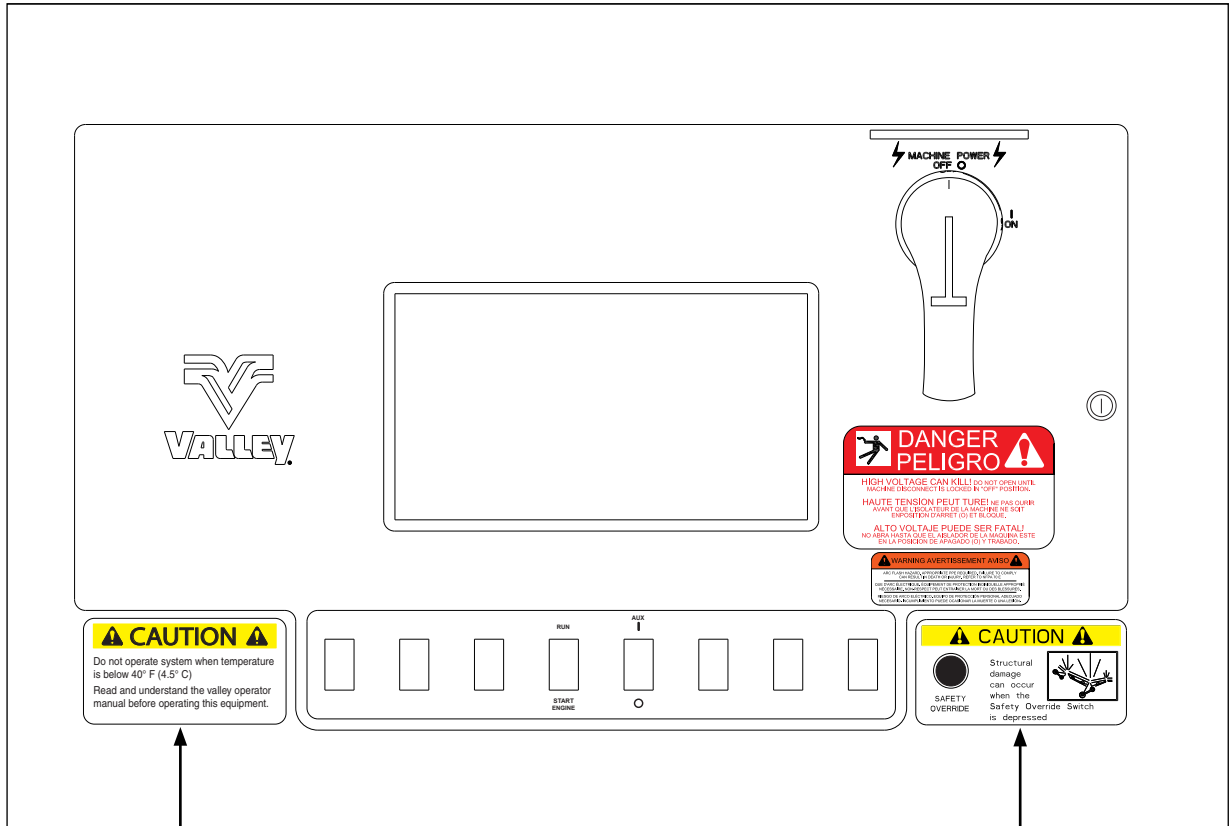

0999135

Safety

Safety Decals (Continued)

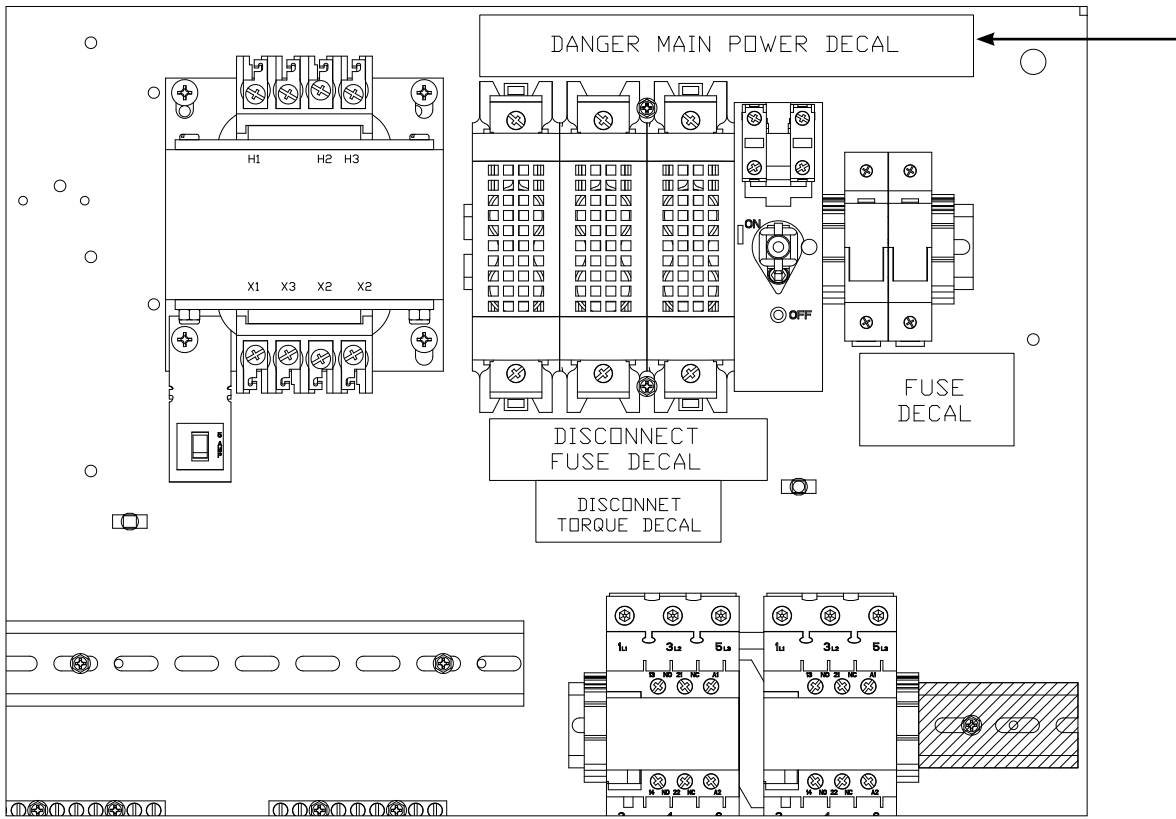

	DANGER PELIGRO	
MAIN POWER SUPPLY CONNECTION USE 60°C MINIMUM INSULATION COPPER WIRE L1 L2 L3	BRANCHEMENT DE L'ALIMENTATION ÉLECTRIQUE PRINCIPALE UTILISER DU FIL DE CUIVRE ISOLATION 60 °C MINIMUM CONEXIÓN DEL SUMINISTRO DE ENERGÍA ELÉCTRICA PRINCIPAL UTILICE CABLES DE COBRE CON AISLAMIENTO PARA 60 °C MÍNIMO	0999119

0999119

DANGER

HIGH VOLTAGE

DO NOT OPEN UNLESS PIVOT
DISCONNECT SWITCH IS IN
THE "OFF" POSITION

0991148

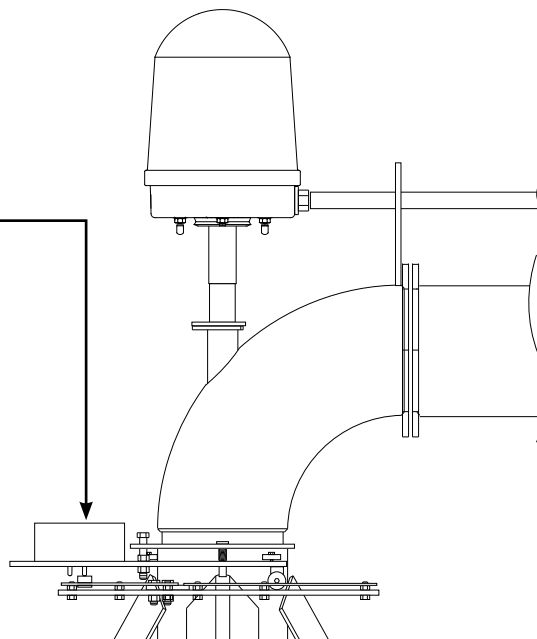

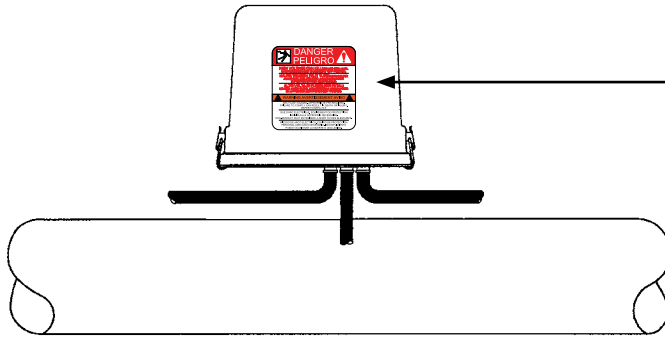

Safety Decals (Continued)





 DANGER PELIGRO 	
<p>HIGH VOLTAGE CAN KILL! DO NOT OPEN UNTIL MACHINE DISCONNECT IS LOCKED IN "OFF" POSITION.</p> <p>HAUTE TENSION PEUT TUE! NE PAS OUIRIR AVANT QUE L'ISOLATEUR DE LA MACHINE NE SOIT EN POSITION D'ARRET (O) ET BLOQUE.</p> <p>ALTO VOLTAJE PUEDE SER FATALI NO ABRA HASTA QUE EL AISLADOR DE LA MAQUINA ESTE EN LA POSICION DE APAGADO (O) Y TRABADO.</p>	
<p>⚠ WARNING AVERTISSEMENT AVISO ⚠</p> <p>ARC FLASH HAZARD, APPROPRIATE PPE REQUIRED. FAILURE TO COMPLY CAN RESULT IN DEATH OR INJURY. REFER TO NFPA 70 E</p> <p>QUE D'ARC ÉLECTRIQUE, ÉQUIPEMENT DE PROTECTION INDIVIDUELLE APPROPRIÉ NÉCESSAIRE. NON-RESPECT PEUT ENTRAÎNER LA MORT OU DES BLESSURES.</p> <p>RIESGO DE ARCO ELÉCTRICO, EQUIPO DE PROTECCIÓN PERSONAL ADECUADO NECESARIO. INCUMPLIMIENTO PUEDE OCASIONAR LA MUERTE O UNA LESIÓN.</p>	

0999122

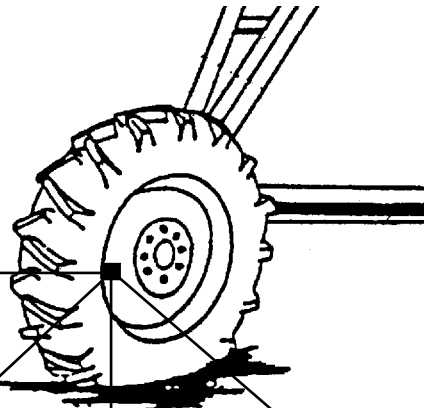

 WARNING
<p>TIRE AND RIM FOR IRRIGATION USE ONLY. ADJUST PRESSURE BEFORE USE. SEE OWNERS MANUAL FOR RECOMMENDED PRESSURE.</p> <p>18 PSI [1.2 BAR] MAXIMUM</p>

0991532





 WARNING
<p>TIRE AND RIM FOR IRRIGATION USE ONLY. ADJUST PRESSURE BEFORE USE. SEE OWNERS MANUAL FOR RECOMMENDED PRESSURE.</p> <p>23 PSI [1.6 BAR] MAXIMUM</p>

0991593

 WARNING
<p>TIRE AND RIM FOR IRRIGATION USE ONLY. ADJUST PRESSURE BEFORE USE. SEE OWNERS MANUAL FOR RECOMMENDED PRESSURE.</p> <p>30 PSI [2.1 BAR] MAXIMUM</p>

0991366

 WARNING
<p>TIRE AND RIM FOR IRRIGATION USE ONLY. ADJUST PRESSURE BEFORE USE. SEE OWNERS MANUAL FOR RECOMMENDED PRESSURE.</p> <p>34 PSI [2.3 BAR] MAXIMUM</p>

0996109

Safety

Control Panel

This Valley control panel uses a Pro2 module with a key pad for execution of operator commands. The key pad works in conjunction with the display screen on the module. See Figure 23-1.

Main Disconnect

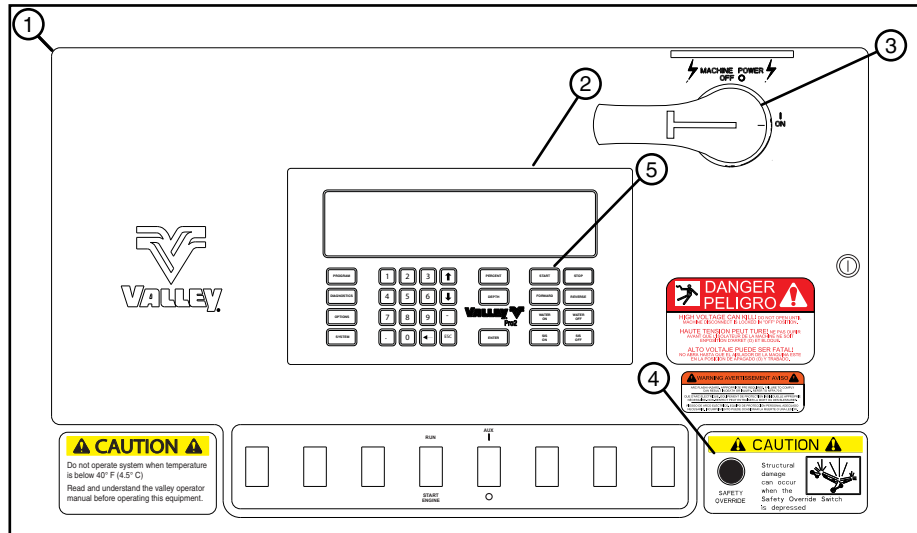

Figure 23-1 1. Control Panel 2. Pro2 Module 3. Main Disconnect Switch 4. Safety Override Switch 5. Start Key

This switch disconnects all power to the machine except at the incoming (upper) terminals on the Main Disconnect Switch inside the control panel. The function of the disconnect is to turn the power ON or OFF. See Figure 23-1.

Safety Override Switch

The machine's safety circuit can be overridden by depressing this switch in conjunction with the start key. See Figure 23-1.

⚠ WARNING

- NEVER DEPRESS THE SAFETY OVERRIDE SWITCH FOR LONGER THAN THREE SECONDS AT ANY TIME. USING THE SAFETY OVERRIDE CAN CAUSE SERIOUS STRUCTURAL DAMAGE. CALL YOUR LOCAL VALLEY DEALER SHOULD YOUR MACHINE FAIL TO START.

Three-Second Delay Timer

A three-second delay timer is standard equipment built into the circuitry of the control panel. In the event of a momentary power loss or voltage drop, the machine will remain running, if power is returned within three seconds.

Pump Restart Delay

When the control panel also controls an irrigation pump that is set to automatically start, the irrigation pump must be protected from damage with a pump restart delay. The pump restart delay must be in the pump circuit between the irrigation machine control panel and the pump.

⚠ CAUTION

- TO REDUCE THE POSSIBILITY OF DAMAGE TO AN AUTOMATICALLY CONTROLLED ELECTRIC PUMP DUE TO A MOMENTARY POWER LOSS OF 3 SECONDS OR LESS, A PUMP RESTART DELAY IS REQUIRED IN THE PUMP CIRCUIT BETWEEN THE IRRIGATION MACHINE CONTROL PANEL AND THE PUMP.

Overview

Control Panel Display - Items 1 and 2

The control panel display is used to show current machine status, and information for programming and selecting functions. When the control panel main disconnect is turned on, and at all other times when the operator is not programming the control panel, the control panel display shows the current machine status on the status screen. See Figure 24-1. A short explanation of the status screen elements is given below and on the following pages.

NOTE: This Status Screen example illustrates the operating conditions of a typical irrigation machine. The Status screen of your machine will show different conditions.

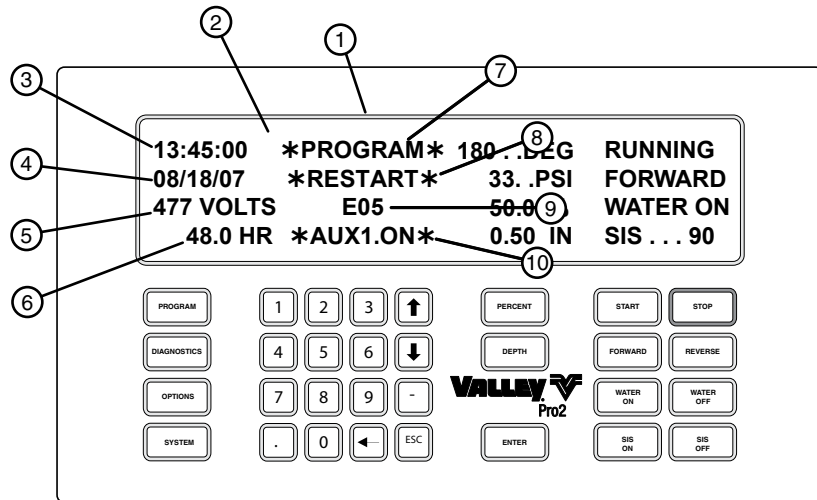

Figure 24-1 1. Control Panel Display 2. Default Status Screen 3. Time 4. Date 5. Voltage 6. Hours/Rev 7. Program Notice 8. Restart Notice 9. Error Code Notice 10. Auxiliary 1 Notice

Time - Item 3

Indicates the current time. If the current time is 1:45:00 P.M., it is displayed on screen in a 24 hour format as 13:45:00. See Figure 24-1.

Date - Item 4

Indicates the current date. If the current date is August 18, 2007, it is displayed on screen as 08/18/07 or 18/08/07, depending on the selected unit of measure. See Figure 24-1.

Voltage - Item 5

Indicates the current operating voltage. The machine will shut down if the voltage drops below the Low Voltage Limit. See Figure 24-1.

Hours/Rev - Item 6

Indicates the number of hours to complete one revolution based on the percent timer setting. See Figure 24-1.

Program Notice - Item 7

Indicates a program has been loaded and is waiting to be executed. See Figure 24-1. If no programs are loaded or waiting the *PROGRAM* message will not appear.

Restart Notice - Item 8

Indicates AUTORESTART, DAILY OPS and/or CYCLE are ON. See Figure 24-1. If AUTORESTART, DAILY OPS and CYCLE are off or inactive, the *RESTART* message will not appear.

Error Code Notice - Item 9

Displays an error code indicating that an input status deviation has been detected. See Figure 24-1. If no input status deviations are detected, the error code notice will not appear.

Auxiliary 1 and 2 Notice - Item 10

Displays AUX1 ON, AUX2 ON, E-GN ON, WB-1 ON, WB-2 ON, and WB-3 ON See Figure 24-1. If more than one are on, the display will toggle between them. If any of them are off, the appropriate *XXXX ON* message will not appear.

Control Panel Display (continued)

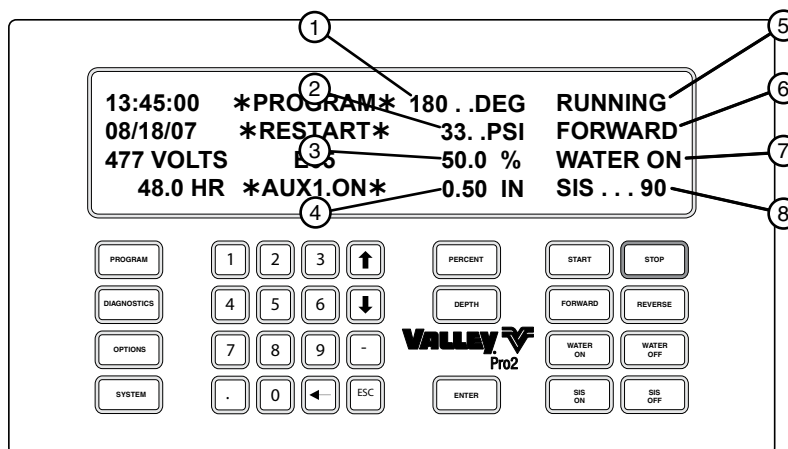

Figure 25-1

1. Field Position	5. Machine Status
2. Water Pressure	6. Direction Status
3. Percent Timer Setting	7. Water Status
4. Depth Setting	8. Stop-In-Slot Notice

Field Position - Item 1

Indicates the machine's current location in the field, which is expressed in degrees. See Figure 25-1.

Water Pressure- Item 2

Indicates the current water pressure at the pressure transducer, in pounds per square inch (psi) or kilopascal (kPa), depending on the selected unit of measure. See Figure 25-1.

Percent Timer Setting - Item 3

Indicates the current pivot or linear percent timer setting. See Figure 25-1.

Depth Setting - Item 4

Indicates the current depth setting in inches or millimeters, depending on the selected unit of measure. See Figure 25-1.

Machine Status - Item 5

Indicates the current status of the irrigation machine either RUNNING, STOPPED or WAITING for water pressure. If the system is stopped, it will always flash between STOPPED and the system fault. See Figure 25-1.

Direction Status - Item 6

Indicates the direction either FORWARD (clockwise) or REVERSE (counter clockwise), that the machine is set to move in or is moving in. See Figure 25-1.

Water Status - Item 7

Indicates the current setting for applying water, either WATER ON or WATER OFF. See Figure 25-1.

Stop-In-Slot Notice - Item 8

Indicates the current Stop-In-Slot setting. See Figure 25-1. If the Stop-In-Slot is ON, the Stop-In-Slot position will be displayed. Example: **SIS...90**. If Stop-In-Slot is off, **SIS...OFF** is displayed.

Overview

Function Keys

The function keys are located on the far left side of the keypad. See Figure 26-1.

The function keys are used to program the panel, view data, and select options not frequently used. Following are explanations of each function key.

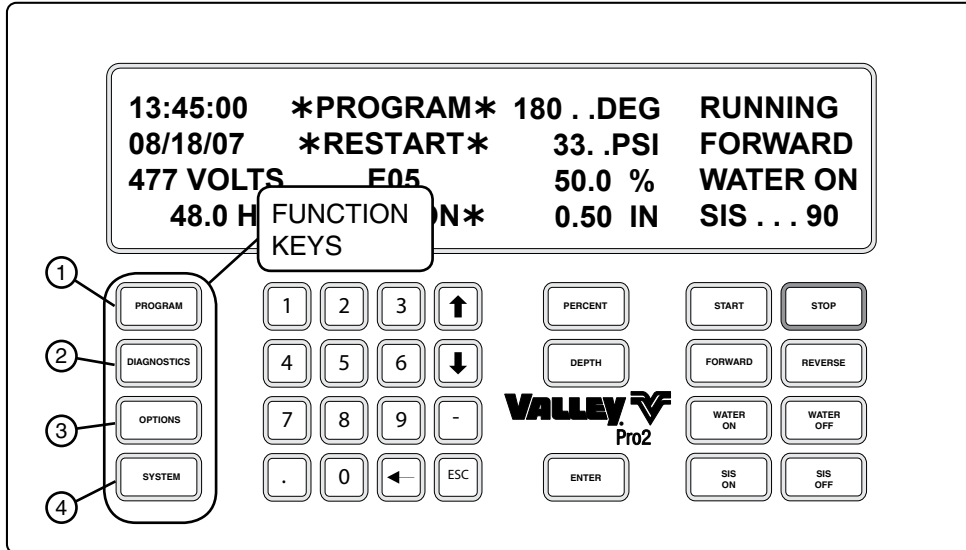

Figure 26-1 1. Program Key 2. Diagnostics Key 3. Options Key 4. System Key

Program Key - Item 1

Use to either write or run programs that execute commands in the future based upon conditions such as date/time and position in the field. See Figure 26-1.

Diagnostics Key - Item 2

Used to assist the operator in determining the cause of an unplanned machine shutdown or potential problem situation. See Figure 26-1.

Options Key - Item 3

Use to control options not frequently used by the operator. See Figure 26-1.

System Key - Item 4

Used to input the constant values of the irrigation machine, reset other values, and view machine operating data. See Figure 27-1.

Numeric Entry Keys

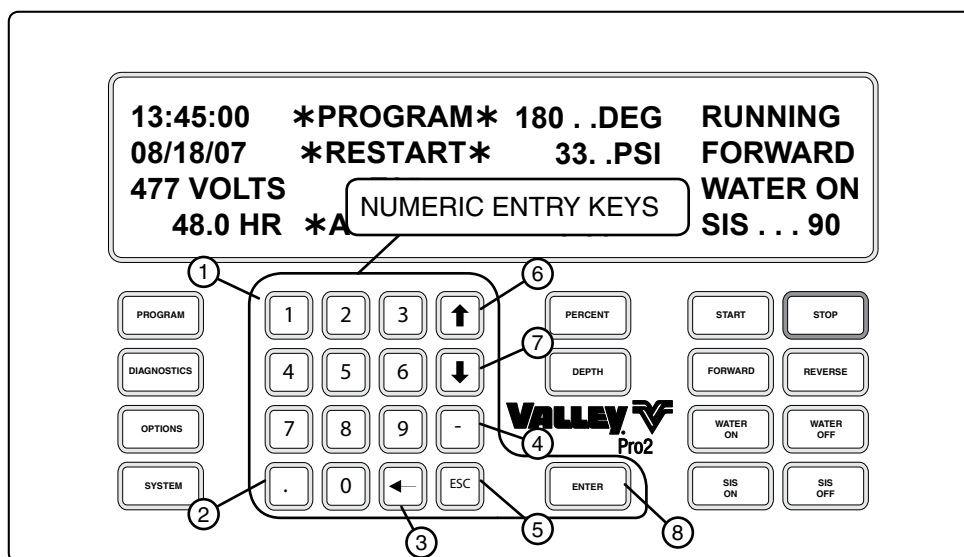

Figure 27-1

1. Number Keys	5. Escape Key
2. Decimal Point Key	6. Contrast Darker Key
3. Back Arrow Key	7. Contrast Lighter Key
4. Minus Sign Key	8. Enter Key

The numeric entry keypad is used to input values such as percentage timer setting, water application depth, SIS setting, etc., and is also used for programming the panel. The functions of these keys are explained below:

Number Keys - Item 1

Use to input numerical values and select programming options. See Figure 27-1.

Decimal Point Key - Item 2

Use to input numerical values in decimal form. See Figure 27-1.

Example: 1.75 inches (44.45 mm).

Back Arrow Key - Item 3

Use to back space and to delete the previous number or symbol. See Figure 27-1.

Minus Sign Key - Item 4

Use to input negative values (generally not used). See Figure 27-1.

Escape Key - Item 5

Use to step backward from the current screen to a previous screen without performing any changes. See Figure 27-1. Repeatedly pressing the escape key will step backward from the current screen, through previous screens until the System Status screen is displayed.

Contrast Darker Key - Item 6

Use to increase the contrast between the text and background on the control panel display. See Figure 27-1.

Contrast Lighter Key - Item 7

Use to decrease the contrast between the text and background on the control panel display. See Figure 27-1.

Enter Key - Item 8

Overview

Use at the end of a numerical value entry or programming sequence. See Figure 28-1.

Command Selection Keys

The command selection keys are used for general operation of the irrigation machine. A short explanation of

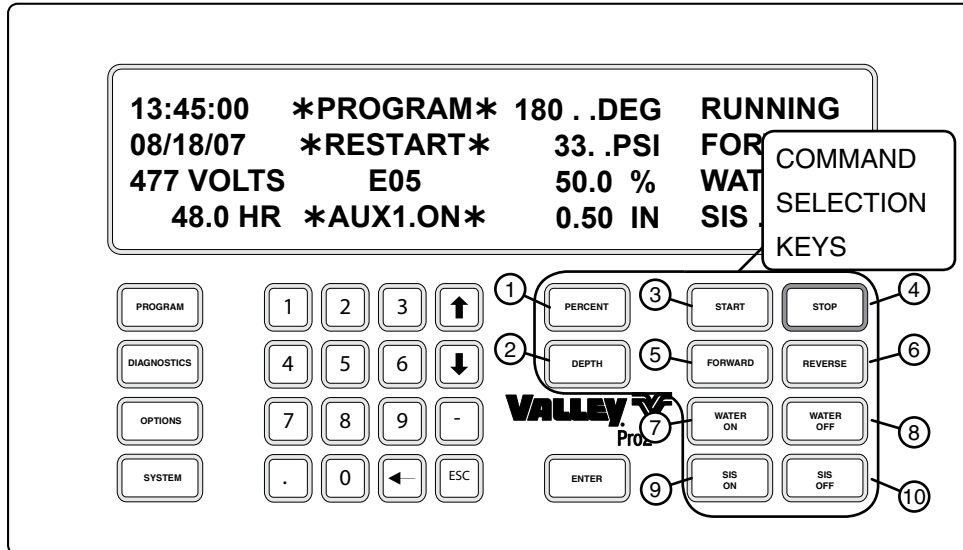

Figure 28-1 1. Percent Key 2. Depth Key 3. Start Key 4. Stop Key 5. Forward Key 6. Reverse Key 7. Water ON Key 8. Water OFF Key 9. Stop-In-Slot ON Key 10. Stop-In-Slot Off Key

each command selection key is given below.

Percent Timer Key - Item 1

Press to set the desired percent timer value. See Figure 28-1.

Depth Key - Item 2

Press to set the desired water application depths in inches or millimeters depending on the selected unit of measure. See Figure 28-1.

Start Key - Item 3

Press to start the machine, assuming safety circuits are operating correctly. The machine has a time delay that will not allow it to be restarted by pressing the Start key within five seconds after being stopped. See Figure 28-1.

Stop Key - Item 4

Press to halt machine movement, shut pump off, and close water valve. See Figure 28-1.

Reverse Key - Item 6

Press to command machine movement in the reverse (counter-clockwise) direction. See Figure 28-1.

Water ON Key - Item 7

Press to command pump to turn on, valve to open (or both) when machine is started. A pre-programmed pressure switch delay is automatically recalled to allow sufficient time for pressure to build up in the machine. See Figure 28-1.

Water OFF Key - Item 8

Press to turn off the pump and/or close water valve. See Figure 28-1.

Stop-In-Slot ON Key - Item 9

Press to engage the stop-in-slot feature, which will stop the machine at a preset location in the field selected by the operator. See Figure 28-1.

Forward Key - Item 5

Press to command machine movement in the forward (clockwise) direction. See Figure 29-1.

Stop-In-Slot OFF Key - Item 10

Press to disengage the stop-in-slot feature. See Figure 29-1.

Symbols and Conventions

This manual uses a few symbols and conventions which are explained below:

Command Prompt

Any command which requires the operator to input data will show a command prompt on the bottom line of the screen.

Next to the command prompt, the screen will display the current value (in parentheses). The value in parentheses is the default value. See Figure 29-1.

If the default value in parentheses is what the operator wants to enter, press the ENTER KEY and this value will be entered. Otherwise, input the desired value.

The command prompt is always identified by > on the bottom line of the screen. See Figure 29-1.

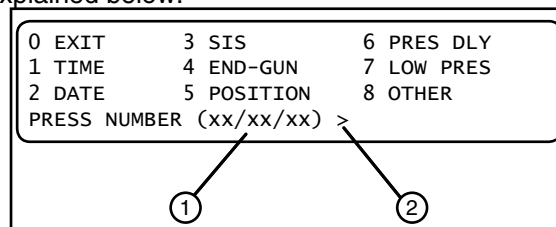



Figure 29-1 1. Default Value
2. Command Prompt

Exiting Screens

Press Escape  one time to step backward from the current screen to the previous screen. Or, press it repeatedly to step backward from the current screen through previous screens until the Status screen is displayed.

Screen Delays

Any screen which is left for more than 60 seconds without pressing a key, will revert back to the previous screen which was displayed. The status screen will eventually be displayed.

Illustrations

The descriptions of procedures throughout this manual consist of instructions illustrating the key or series of keys to press, followed by the decision screen that is displayed. This convention will be used throughout the manual. See Figure 29-2.

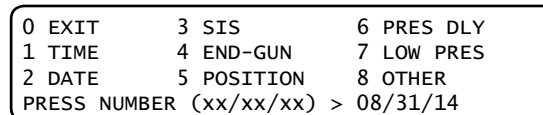











Figure 29-2

1. Press , , and  for the Date screen. See Figure 29-2.

2. The date is entered in a month/day/year format when the unit of measure is set to inch or day/month/year format when unit of measure is set to metric.

If the date is 08/31/07 and the unit of measure is set to inch.

Press , , , , ,  for 08/31/07. See Figure 29-2.

3. Press  to retain 08/31/07 as the date.

Overview

Control Panel Setup

Set up the control panel for use by completing the Minimum Control Panel Setup steps in this section. Reference tables are included in this section for Voltage, Low Voltage, Estimated Drive Speed, and GPS Angular Conversion of minutes and seconds into decimal degrees. Listed below are the setup and reference table locations.

Contents

Minimum Control Panel Setup	33
Set Position Using the Manual Method (No GPS)	34
Set GPS Position and Fallback Run Time Manual Method (Machines with GPS)	35
Setup GPS Position Loss.....	37
Test and Adjust the GPS Position	39
Voltage.....	40
Low Voltage	40
Estimated Drive Unit Speed Table	40
GPS Angular Conversion Table	41
Angular Degree Examples.....	41
System Constants Record.....	42

If desired, control panel settings can be recorded on the System Constants Record at the end of this section.

Control Panel Setup

Minimum Control Panel Setup

To set up the control panel for use with standard positioning or GPS positioning, follow these steps.

Set the Language and Unit of Measure.

1. Press **SYSTEM**, **7** for LANGUAGE. See Figure 33-1.

2. Select the desired language. See Figure 33-2.

1 = English

2 = Spanish

3 = French

4 = Italian

5 = Portuguese

6 = Romanian

7 = Hungarian.

3. Select the desired Unit of Measure. See Figure 33-3.

0 = Inches

1 = Metric.

Set the Current Time:

1. Press **SYSTEM**, **1**, **1** for TIME. See Figure 33-4.

2. Enter the time in the 24 hour format.

3. Press **ENTER** to retain the value.

Set the Current Date:

1. Press **SYSTEM**, **1**, **2** for DATE. See Figure 33-5.

2. Enter the current date.

- When the Unit of Measure is set to Inches, enter the date in a mm/dd/yy format.
- When unit of measure is set to Metric, enter the date in a dd/mm/yy format.

3. Press **ENTER** to retain the value.

Set the Pivot Minimum Application:

1. Press **SYSTEM**, **1**, **8**, **1** for MIN APP. See Figure 33-6.

2. Enter the Pivot Minimum Application rate from the VChart Report for this machine.

3. Press **ENTER** to retain the value.

```

0 EXIT      3 RESET    6 TRANSMIT
1 CONSTANTS 4 REVIEW    7 LANGUAGE
2 DATA     5 CYCLE   8 HOURS
PRESS NUMBER >
    
```

Figure 33-1

```

0 EXIT      3 FRANCAIS  6 ROMANA
1 ENGLISH   4 ITALIANO  7 MAGYAR
2 ESPANOL   5 PORTUGUES
PRESS NUMBER >
    
```

Figure 33-2

```

0 EXIT      3 FRANCAIS  6 ROMANA
1 ENGLISH   4 ITALIANO  7 MAGYAR
2 ESPANOL   5 PORTUGUES
0..IN  1..MM (0) >
    
```

Figure 33-3

```

0 EXI      3 SIS      6 PRES DLY
1 TIME     4 END-GUN  7 LOW PRES
2 DATE     5 POSITION  8 OTHER
CURRENT TIME (06:24) >
    
```

Figure 33-4

```

0 EXI      3 SIS      6 PRES DLY
1 TIME     4 END-GUN  7 LOW PRES
2 DATE     5 POSITION  8 OTHER
CURRENT DATE (06/11/14) >
    
```

Figure 33-5

```

0 EXIT      3 VOLTAGE  6 RTU ID
1 MIN APP   4 WIDE BND  7 DAILY OPS
2 HRS/REV   5 FLOWMETER 8 OTHER
MINIMUM APPLICATION (0.250) >
    
```

Figure 33-6

Control Panel Setup

Minimum Control Panel Setup (Continued)

Set the Pivot Time Per Revolution:

1. Press **SYSTEM**, **1**, **8**, **2** for HRS/REV. See Figure 34-1.
2. Enter the Pivot Time Per Revolution from the VChart Report for this machine.
3. Press **ENTER** to retain the value.

```
0 EXIT          3 VOLTAGE      6 RTU ID
1 MIN APP      4 WIDE BND    7 DAILY OPS
2 HRS/REV     5 FLOWMETER 8 OTHER
TIME PER REVOLUTION ( 24.0) >
```

Figure 34-1

Set the Current Voltage:

1. Press **SYSTEM**, **1**, **8**, **3** for VOLTAGE. See Figure 34-2.
2. Enter the current voltage. See Voltage on page 39.
3. Press **ENTER** to retain the value.

```
0 EXIT          3 VOLTAGE      6 RTU ID
1 MIN APP      4 WIDE BND    7 DAILY OPS
2 HRS/REV     5 FLOWMETER 8 OTHER
CURRENT VOLTAGE (480) >
```

Figure 34-2

Set the Low Voltage Limit if lower than 440 volts:

1. Press **SYSTEM**, **1**, **8**, **8**, **4** for LOW VOLTAGE. See Figure 34-3.
2. Enter the low voltage limit. Refer to the Low Voltage section of this manual.
3. Press **ENTER** to retain the value.

```
0 EXIT          3 PERCENT TIMER 6 ENGINE/PUMP
1 WIND          4 LOW VOLTAGE  7 COM PORT
2 DATA         5 DIR OFFSET  8 OTHER
LOW VOLTAGE LIMIT (440) >
```

Figure 34-3

Calibrate the water pressure transducer to the current water pressure of zero:

1. With the pump OFF and the machine dry, press **SYSTEM**, **1**, **8**, **8**, **8**, **1**. See Figure 34-4.
2. Press **1** for CALIBRATE.

```
0 EXIT          3 BACKLIGHT  6 TIRE PRES
1 PRES CAL      4 CRUISE CTL  7 END PRES
2 PRES TYPE     5 VRI-ZONE   8 OTHER
0 CANCEL        1 CALIBRATE >
```

Figure 34-4

The initial control panel setup is complete. Program the position-related control panel settings based on how the machine is equipped.

- If the machine is equipped with GPS Positioning, complete the Set GPS Position and Fallback Run Time Manual Method (Machines with GPS) instructions on the next page.
- If the machine is not equipped with GPS Positioning, continue with Set Position (No GPS) below to complete the minimum control panel setup for a machine without GPS positioning.

Set Position (No GPS)

To set the current position of a machine that is not equipped with GPS positioning, follow these steps:

1. Press **SYSTEM**, **1**, **5** for POSITION. See Figure 34-5.
2. Enter position in degrees.
3. Press **ENTER** to retain the value.

```
0 EXI           3 SIS          6 PRES DLY
1 TIME          4 END-GUN     7 LOW PRES
2 DATE          5 POSITION     8 OTHER
CURRENT POSITION ( 0.0)) >
```

Figure 34-5

Minimum control panel setup of a machine that is not equipped with GPS Position is complete.

Minimum Control Panel Setup (Continued)

Set GPS Position and Fallback Run Time Manual Method (Machines with GPS)

If the machine is equipped with GPS Positioning, complete the following instructions to set the pivot point position and fallback run time, thus completing the minimum control panel setup for a machine with GPS Positioning.

Before you set up the GPS position you must do the following.

- Obtain the last tower speed, distance to GPS, and pivot length information from the VChart Report for this machine, or measure the span length from the pivot to the last regular drive unit, not including the overhang. Use the Estimated Drive Unit Speed chart in this section.
- Use a handheld GPS receiver to obtain the GPS coordinates for the Pivot Point position.
- If necessary, use the GPS Angular Conversion chart in this section to convert the GPS coordinate values into decimals of degree.
- If necessary, update all Power Line Carrier (PLC) board firmware to version 2.

To set the GPS position and fallback run time, follow these steps.

Set the 25-Pin Com Port protocol to GPS V2:

1. Press **SYSTEM**, **1**, **8**, **8**, **7**, **2**, **1**, **3**, **1** for GPS V2. See Figure 35-1.
2. Enter the PLC ID for the GPS tower box. See Figure 35-2.
3. Press **ENTER** to retain value.
4. Press **ESC**, **ESC** to enter the baud rate.

```
POWER LINE CARRIER OPTIONS          *=ON
1*GPS V2      3 VRI-ZONE      5 PLC WIDE BND
2 TIRE PRES  4 WATER PRES
PRESS NUMBER TO TOGGLE > 1
```

Figure 35-1

Set the Baud Rate value to 4800 baud:

1. Press **2**, **4** for 4800 baud. See Figure 35-3.
2. Press **SYSTEM** to go back to the status screen.

```
POWER LINE CARRIER OPTIONS          *=ON
1*GPS V2      3 VRI-ZONE      5 PLC WIDE BND
2 TIRE PRES  4 WATER PRES
ENTER PLC ID FOR GPS V2 ( ) >
```

Figure 35-2

Set the Pivot Point position using EDIT:

1. Press **SYSTEM**, **1**, **5**, **1**, **2** for EDIT. See Figure 35-4.
2. Enter the latitude. Press **ENTER** to retain value. See Figure 35-5.
3. Enter the longitude. Press **ENTER** to retain value. See Figure 35-6.
4. Press **SYSTEM** to go back to the System Status screen.

```
0 EXIT      1 300      4 4800      7 38400
            2 1200      5 9600      8 57600
            3 2400      6 19200     9 115200
SELECT BAUD RATE ( 57600 ) > 4
```

Figure 35-3

NOTE

- Latitude and Longitude positions displayed on a handheld GPS receiver are usually displayed as North, South, East or West.
- The direction displayed affects how the position is entered into the control panel.
- If the position is shown as West or South the position MUST be entered as a Negative Degree.
- In North America, latitude positions are always positive, and longitude positions are always negative.

```
POSITION: PIVOT POINT, (CURRENT)
LATITUDE: 89.500000, ( )
LONGITUDE: 179.500000, ( )
PRESS 1..SET TO CURRENT 2..EDIT >
```

Figure 35-4

```
POSITION: PIVOT POINT, (CURRENT)
LATITUDE: 89.500000, ( )
LONGITUDE: 179.500000, ( )
ENTER LATITUDE > 90.5
```

Figure 35-5

```
POSITION: PIVOT POINT, (CURRENT)
LATITUDE: 90.500000, ( )
LONGITUDE: 179.500000, ( )
ENTER LONGITUDE > 178.0
```

Figure 35-6

Continue with Set the Fallback Position Run Time on the next page.

Control Panel Setup

Minimum Control Panel Setup (Continued)

Set GPS Position and Fallback Run Time Manual Method (Machines with GPS)

Set the Fallback Position Run Time:

1. Press **SYSTEM**, **1**, **5**, **2**, **3**, **1** for FALLBACK POSITION ON. See Figure 36-1.
2. Press **1** for RUNTIME. See Figure 36-2.
3. Enter the pivot speed. The default is 15.56 ft./min (4.8 m/min). See Figure 36-3.
4. Press **ENTER** to retain value.
5. Enter pivot length. The default is 1320 ft (402.3 m). See Figure 36-4.
6. Press **ENTER** to retain the value.
7. Press **SYSTEM** to go back to the System Status screen.

Set the Distance to GPS (The distance from pivot point to GPS tower box):

1. Press **SYSTEM**, **1**, **5**, **4** for DISTANCE TO GPS. See Figure 36-5.
2. Enter the length from the pivot point to the GPS receiver. Do not enter the pivot length. The default is 1320 ft (402.3 m), and the range is 10 to 6554 ft (3.0 to 1997.6 m). See Figure 36-6.
3. Press **ENTER** to retain the value.
4. Enter the Plus tolerance for the length from pivot point to GPS receiver. The Default is 50 ft (15.2 m) and the range is 10 to 6554 ft (3.0 to 1997.6 m). A setting of 50 ft (15.2 m) or more is recommended to allow for variation in the GPS signal if Wide Area Application Services (WAAS) is unavailable. See Figure 36-7.
5. Press **ENTER** to retain the value.
6. Enter the Minus tolerance for the length from pivot point to GPS receiver. The Default is 50 ft (15.2 m) and the range is 10 to 6554 ft (3.0 to 1997.6 m). A setting of 50 ft (15.2 m) or more is recommended to allow for variation in the GPS signal if WAAS is unavailable. See Figure 36-8.
7. Press **ENTER** to retain the value.
8. Press **SYSTEM** to go back to the status screen.

Continue with **Set Up Position Loss on the next page**, or proceed to **Test GPS Position**.

```
IN EVENT OF GPS SIGNAL LOSS      *=ON
1 SHUTDOWN SYSTEM      3 FALLBACK POSITION
2 DISABLE ENDGUNS
FALLBACK POSITION 1..ON 0..OFF >
```

Figure 36-1

```
IN EVENT OF GPS SIGNAL LOSS      *=ON
1 SHUTDOWN SYSTEM      3 FALLBACK POSITION
2 DISABLE ENDGUNS
SELECT 1..RUNTIME 2..RESOLVER (1) >
```

Figure 36-2

```
IN EVENT OF GPS SIGNAL LOSS      *=ON
1 SHUTDOWN SYSTEM      3 FALLBACK POSITION
2 DISABLE ENDGUNS
PIVOT SPEED FT/MIN (15.560) >
```

Figure 36-3

```
IN EVENT OF GPS SIGNAL LOSS      *=ON
1 SHUTDOWN SYSTEM      3 FALLBACK POSITION
2 DISABLE ENDGUNS
PIVOT LENGTH FT (1320) >
```

Figure 36-4

```
0 EXIT      3 PIVOT POSITION
1 PIVOT POINT  4 DISTANCE TO GPS
2 POSITION LOSS
PRESS NUMBER >
```

Figure 36-5

```
0 EXIT      3 PIVOT POSITION
1 PIVOT POINT  4 DISTANCE TO GPS
2 POSITION LOSS
DISTANCE TO GPS (1320) FT >
```

Figure 36-6

```
0 EXIT      3 PIVOT POSITION
1 PIVOT POINT  4 DISTANCE TO GPS
2 POSITION LOSS
PLUS ( 50) FT >
```

Figure 36-7

```
0 EXIT      3 PIVOT POSITION
1 PIVOT POINT  4 DISTANCE TO GPS
2 POSITION LOSS
MINUS ( 50) FT >
```

Figure 36-8

Minimum Control Panel Setup (Continued)

Setup GPS Position Loss

In the event of GPS position loss, three different position loss functions can be used either independently or with each other to control machine operation. Listed below are the functions and their default settings.

- **Shutdown System:** When ON, this shuts the system down if the GPS position is lost for a specified period of time. The default setting is ON with 20 minute delay.
- **Disable End Guns:** When ON, this disables the end guns if the GPS position is lost for a specified period of time. The default setting is OFF with 10 minute delay.
- **Fallback Position:** When ON, if the GPS position is lost, the position is calculated using Runtime or Resolver until the GPS position is re-acquired. The default setting is ON with Run Time.

Shutdown System

To set up Shutdown System, do the following:

1. Press **SYSTEM**, **1**, **5**, **2** to display the Shutdown System screen. See Figure 37-1.
2. Press **1** for SHUTDOWN SYSTEM. See Figure 37-2.
3. Press **1** to turn Shutdown System ON. The default is OFF.
4. Enter the delay time in minutes. The range is 1 to 255 minutes. The default is 20 minutes. See Figure 37-3.
5. Press **ENTER** to retain the value.

```
IN EVENT OF GPS SIGNAL LOSS      *=ON
1 SHUTDOWN SYSTEM      3 FALLBACK POSITION
2 DISABLE ENDGUNS
PRESS NUMBER TO TOGGLE > 1
```

Figure 37-1

```
IN EVENT OF GPS SIGNAL LOSS      *=ON
1*SHUTDOWN SYSTEM      3 FALLBACK POSITION
2 DISABLE ENDGUNS
SYSTEM SHUTDOWN 1..ON 0..OFF > 1
```

Figure 37-2

```
IN EVENT OF GPS SIGNAL LOSS      *=ON
1*SHUTDOWN SYSTEM      3*FALLBACK POSITION
2 DISABLE ENDGUNS
SYSTEM SHUTDOWN DELAY MIN ( 20) >
```

Figure 37-3

Disable End guns

To set up Disable End guns, do the following:

1. Press **SYSTEM**, **1**, **5**, **2** to display the Disable Eng-guns screen. See Figure 37-4.
2. Press **2** for DISABLE ENDGUNS. See Figure 37-5.
3. Press **1** to turn DISABLE ENDGUNS ON. The default is OFF.
4. Enter the delay time in minutes. The range is 1 to 255 minutes. The default is 10 minutes. See Figure 37-6.
5. Press **ENTER** to retain the value.

```
IN EVENT OF GPS SIGNAL LOSS      *=ON
1 SHUTDOWN SYSTEM      3 FALLBACK POSITION
2 DISABLE ENDGUNS
PRESS NUMBER TO TOGGLE > 2
```

Figure 37-4

```
IN EVENT OF GPS SIGNAL LOSS      *=ON
1 SHUTDOWN SYSTEM      3*FALLBACK POSITION
2*DISABLE ENDGUNS
DISABLE ENDGUNS 1..ON 0..OFF > 1
```

Figure 37-5

```
IN EVENT OF GPS SIGNAL LOSS      *=ON
1 SHUTDOWN SYSTEM      3*FALLBACK POSITION
2*DISABLE ENDGUNS
DISABLE ENDGUNS DELAY MIN ( 10) >
```

Figure 37-6

Control Panel Setup

Minimum Control Panel Setup (Continued)

Set Up Position Loss Fallback Position

To set up the Fallback Position, do the following:

1. Press **SYSTEM**, **1**, **5**, **2** to display the Position Loss screen. See Figure 38-1.
2. Press **3** for FALLBACK POSITION. See Figure 38-2.
3. Press **1** to turn FALLBACK POSITION ON. The default is OFF.
4. Press **1** to select RUNTIME (recommended) as the position calculation mode. The default is Run Time. See Figure 38-3.
5. Enter the pivot speed. The default is 15.56 ft./min (4.8 m/min). See Figure 38-4.
6. Press **ENTER** to retain the value.
7. Enter the pivot length. The default is 1320 ft (402.3 m). See Figure 38-5.
8. Press **ENTER** to retain the value.

Proceed to Test And Adjust the GPS Position on the next page.

```
IN EVENT OF GPS SIGNAL LOSS      *=ON
1 SHUTDOWN SYSTEM      3 FALLBACK POSITION
2 DISABLE ENDGUNS
PRESS NUMBER TO TOGGLE > 3
```

Figure 38-1

```
IN EVENT OF GPS SIGNAL LOSS      *=ON
1 SHUTDOWN SYSTEM      3 FALLBACK POSITION
2 DISABLE ENDGUNS
FALLBACK POSITION 1..ON  0..OFF > 1
```

Figure 38-2

```
IN EVENT OF GPS SIGNAL LOSS      *=ON
1 SHUTDOWN SYSTEM      3*FALLBACK POSITION
2 DISABLE ENDGUNS
SELECT 1..RUNTIME 2..RESOLVER (1) > 1
```

Figure 38-3

```
IN EVENT OF GPS SIGNAL LOSS      *=ON
1 SHUTDOWN SYSTEM      3*FALLBACK POSITION
2 DISABLE ENDGUNS
PIVOT SPEED FT/MIN (15.560) >
```

Figure 38-4

```
IN EVENT OF GPS SIGNAL LOSS      *=ON
1 SHUTDOWN SYSTEM      3*FALLBACK POSITION
2 DISABLE ENDGUNS
PIVOT LENGTH FT (1320) >
```

Figure 38-5

Minimum Control Panel Setup (Continued)

Test and Adjust the GPS Position

NOTE

•Initially it may be necessary to run the machines in both directions so that the position displayed on the screen is accurate. When the direction of travel changes, the position is updated with the GPS position.

If the machine is equipped with GPS positioning, do the following to verify that GPS Position is working:

1. Press **SYSTEM**, **1**, **5**, **3** to view the Position screen. See Figure 39-1.

The Position screen displays the following information:

- **CURRENT POSITION** - The unfiltered and filtered GPS positions are displayed.
- **SAT COUNT** - Displays the number of satellites in view.
- **LOCK** - Displays the satellite signal (None, Standard, or DGPS) that the GPS receiver is locked on.
- **LAT** - Displays the current latitude.
- **LON** - Displays the current longitude.
- **CURRENT POSITION** - Displays the current position of the machine.

```
CURRENT POSITION: 288.3 -> 175.6
SAT COUNT: 8          LOCK: DGPS
LAT: ( 30.297895)   LON: (-127.739125)
CURRENT POSITION (175.6) >
```

Figure 39-1

2. Run the machine in either direction to verify that the position displayed on the status screen changes as the machine moves.
 - If GPS Position is not working, refer to the Troubleshooting section.
 - If GPS Position is working, the installation is complete.
3. If 0 degrees north is not desired, set the position of the pivot span in degrees. The position value is located on the Position screen. The position screen must be showing satellite signal lock in order to edit the position. The default position is 0 degrees, machine pointing north.

To set the pivot span's position, follow these steps:

- a) Press **SYSTEM**, **1**, **5** for the Position screen. See Figure 39-2.
- b) Press **3** for Pivot Position. See Figure 39-3.
- c) Enter the desired position. See Figure 39-4.
- d) Press **ENTER** to retain the value.
- e) Press **SYSTEM** to go back to the status screen.

```
0 EXIT          3 SIS          6 PRES DLY
1 TIME         4 END-GUN      7 LOW PRES
2 DATE         5 POSITION     8 OTHER
CURRENT POSITION ( 0.0) >
```

Figure 39-2

```
0 EXIT          3 PIVOT POSITION
1 PIVOT POINT   4 DISTANCE TO GPS
2 POSITION LOSS
ENTER NUMBER >
```

Figure 39-3

```
CURRENT POSITION:          -> 0.0
SAT COUNT:                LOCK:
LAT: ( )                 LON: ( )
CURRENT POSITION ( 0.0) >
```

Figure 39-4

Control Panel Setup

Voltage

The Voltage constant calibrates the volt meter with the actual voltage coming into the control panel so that the voltage fluctuations can be monitored correctly.

The incoming voltage to the control panel must be measured with a meter by a qualified electrician or service person. This value is entered as the voltage constant.

The supply voltage should never exceed the limits shown in the Maximum Supply Voltage chart. See Figure 40-1.

Nominal Supply Voltage	Maximum Supply Voltage
480 VAC @ 60Hz	505 VAC
415 VAC @ 50Hz	420 VAC
400 VAC @ 50Hz	420 VAC
380 VAC @ 50Hz	420 VAC
230 VAC @ 60Hz	253 VAC
220 VAC @ 50Hz	243 VAC
120 VAC @ 60Hz	132 VAC
110 VAC @ 50Hz	121 VAC

Figure 40-1 Maximum Supply Voltage

Low Voltage

The Low Voltage constant is used to set the low voltage limit. The low voltage limit factory default setting is 440 volts for use with a supply voltage of 480 VAC @ 60Hz. Recommended low voltage limits for other supply voltages are shown in the Recommended Low Voltage chart. See Figure 40-2.

If the control panel voltmeter senses voltage below the low voltage limit, a built-in timer keeps the machine running for up to 15 seconds to prevent nuisance shutdowns due to voltage fluctuations.

If the low voltage condition still exists after 15 seconds, the machine will be shut down and the diagnostics screen will display a fault for machine power.

Nominal Supply Voltage	Recommended Low Voltage Setting
480 VAC @ 60Hz	440 VAC
415 VAC @ 50Hz	375 VAC
400 VAC @ 50Hz	365 VAC
380 VAC @ 50Hz	355 VAC
230 VAC @ 60Hz	220 VAC
220 VAC @ 50Hz	210 VAC
120 VAC @ 60Hz	105 VAC
110 VAC @ 50Hz	95 VAC

Figure 40-2 Recommended Low Voltage

CAUTION

- DO NOT SET LOW VOLTAGE LOWER THAN THE RECOMMENDED LOW VOLTAGE LIMIT.
- LOW VOLTAGE WILL DAMAGE THE DRIVE MOTORS AND OTHER ELECTRICAL COMPONENTS. CORRECT THE PROBLEM BEFORE RESUMING OPERATION

Estimated Drive Unit Speed Table

Use this table to estimate the Intermediate Drive Unit and End Drive Unit speed based on the drive unit motor output RPM, tire size, and machine voltage. See Figure 40-3.

Estimated Drive Unit Speed																
Drive Unit Motor Output RPM	Tire Sizes / Machine Voltage and Hertz															
	11.2 x 24				14.9 x 24				16.9 x 24				11.2 x 38			
	480 Volt 60Hz		380 Volt 50Hz		480 Volt 60Hz		380 Volt 50Hz		480 Volt 60Hz		380 Volt 50Hz		480 Volt 60Hz		380 Volt 50Hz	
	ft./min.	M/min.	ft./min.	M/min.	ft./min.	M/min.	ft./min.	M/min.	ft./min.	M/min.	ft./min.	M/min.	ft./min.	M/min.	ft./min.	M/min.
29	5.90	1.80	4.91	1.50	6.54	1.99	5.45	1.66	6.98	2.13	5.81	1.77	8.06	2.45	6.71	2.04
30	6.10	1.86	5.08	1.55	6.77	2.06	5.64	1.72	7.22	2.20	6.01	1.83	8.34	2.54	6.95	2.12
34	6.95	2.12	5.79	1.76	7.40	2.25	6.16	1.88	8.16	2.48	6.80	2.07	9.45	2.88	7.87	2.40
35	7.12	2.17	5.93	1.81	7.89	2.40	6.57	2.00	8.42	2.56	7.01	2.14	9.73	2.96	8.11	2.47
37	7.53	2.29	6.27	1.91	8.53	2.60	7.11	2.16	8.90	2.71	7.41	2.26	10.28	3.13	8.56	2.61
43	8.75	2.66	7.29	2.22	9.91	3.02	8.26	2.51	10.34	3.15	8.61	2.62	11.94	3.64	9.95	3.03
56	11.39	3.47	9.49	2.89	12.63	3.85	10.52	3.20	13.48	4.10	11.23	3.42	15.56	4.74	12.96	3.95
58	11.80	3.59	9.83	2.99	13.08	3.98	10.90	3.32	13.96	4.25	11.63	3.54	16.12	4.91	13.43	4.09
68	13.84	4.21	11.53	3.51	15.34	4.67	12.78	3.89	16.36	4.98	13.63	4.15	18.90	5.76	15.74	4.79
69	14.03	4.27	11.69	3.56	15.57	4.74	12.97	3.95	16.60	5.05	13.83	4.21	19.18	5.84	15.98	4.86

Figure 40-3 Estimated Drive Unit Speed Table

GPS Angular Conversion Table

Use the GPS Angular Conversion table to convert the GPS angular degrees from minutes and seconds to decimal degrees when manually setting up the GPS coordinates in the Pro2 control panel. See Figure 41-1.

Minutes and Seconds into Decimals of a Degree											
(Based on 1 second = 0.00027778 degrees)											
Minutes into Decimals of a Degree						Seconds into Decimals of a Degree					
Min.	Deg.	Min.	Deg.	Min.	Deg.	Sec.	Deg.	Sec.	Deg.	Sec.	Deg.
1	0.0167	21	0.3500	41	0.6833	1	0.0003	21	0.0058	41	0.0114
2	0.0333	22	0.3667	42	0.7000	2	0.0006	22	0.0061	42	0.0117
3	0.0500	23	0.3833	43	0.7167	3	0.0008	23	0.0064	43	0.0119
4	0.0667	24	0.4000	44	0.7333	4	0.0011	24	0.0067	44	0.0122
5	0.0833	25	0.4167	45	0.7500	5	0.0014	25	0.0069	45	0.0125
6	0.1000	26	0.4333	46	0.7667	6	0.0017	26	0.0072	46	0.0128
7	0.1167	27	0.4500	47	0.7833	7	0.0019	27	0.0075	47	0.0131
8	0.1333	28	0.4667	48	0.8000	8	0.0022	28	0.0078	48	0.0133
9	0.1500	29	0.4833	49	0.8167	9	0.0025	29	0.0081	49	0.0136
10	0.1667	30	0.5000	50	0.8333	10	0.0028	30	0.0083	50	0.0139
11	0.1833	31	0.5167	51	0.8500	11	0.0031	31	0.0086	51	0.0142
12	0.2000	32	0.5333	52	0.8667	12	0.0033	32	0.0089	52	0.0144
13	0.2167	33	0.5500	53	0.8833	13	0.0036	33	0.0092	53	0.0147
14	0.2333	34	0.5667	54	0.9000	14	0.0039	34	0.0094	54	0.0150
15	0.2500	35	0.5833	55	0.9167	15	0.0042	35	0.0097	55	0.0153
16	0.2667	36	0.6000	56	0.9333	16	0.0044	36	0.0100	56	0.0156
17	0.2833	37	0.6167	57	0.9500	17	0.0047	37	0.0103	57	0.0158
18	0.3000	38	0.6333	58	0.9667	18	0.0050	38	0.0106	58	0.0161
19	0.3167	39	0.6500	59	0.9833	19	0.0053	39	0.0108	59	0.0164
20	0.3333	40	0.6667	60	1.0000	20	0.0056	40	0.0111	60	0.0167

Figure 41-1 GPS Angular Conversion Table

Angular Degree Examples

An angular degree in degrees, minutes, seconds will look like the following examples:

- $10^{\circ} 11' 37''$, reads as 10 degrees, 11 minutes, 37 seconds.
 - (a) Convert minutes and seconds to a decimal degree value using the table in Figure 41-1.
 - 11 minutes = 0.1833 degrees
 - 37 seconds = 0.0103 degrees.
 - (b) Add all decimal degree values together.
 - 10 degrees = 10.0000 degrees
 - 11 minutes = 0.1833 degrees
 - 37 seconds = 0.0103 degrees
 - $10^{\circ} 11' 37'' = 10.1936$ degrees**
- $12^{\circ} 5.245'$, read as 12 degrees, 5.245 minutes.
 - (a) Convert decimals of a minute to decimal degrees using the table in 41-1 and multiply the decimal of a minute by 0.0167.
 - 5 minutes = 0.0833 degrees
 - 0.245 minutes =
 - $0.245 \times 0.0167 = 0.0041$ degrees
 - (b) Add all decimal degree values together.
 - 12 degrees = 12.0000 degrees
 - 5 minutes = 0.0833 degrees
 - 0.245 minutes = 0.0041 degrees
 - $10^{\circ} 11' 37'' = 12.0874$ degrees**

Control Panel Setup

System Constants Record

Enter system constants as needed. If desired, fill in the form below with the applicable constants for this machine.

Constants Screen 1			
SIS			
	Stop-In-Slot Position		
End Gun			
	Sequence	Left Angle	Right Angle
	1		
	2		
	3		
	4		
	5		
	6		
	7		
	8		
	9		
Position			
	Pivot Point		
	Latitude		
	Longitude		
	Position Loss		
	Distance to GPS		
	Plus		
	Minus		
Pres Dly			
	Startup Pressure Delay in Seconds		
	Operating Pressure Delay in Seconds		
Low Pres			
	Low Pressure Limit		

Constants Screen 2			
Min App			
	Minimum Application		
Hrs/Rev			
	Time Per Revolution		
Voltage			
	Current Voltage		
Wide Bnd			
	Sequence	Left Angle	Right Angle
	1		
	2		
	3		
	4		
	5		
	6		
	7		
	8		
	9		
Flowmeter			
	Flowmeter Pulse Rate		
RTU ID			
	Three Digit ID Number		
Daily Ops			
	Daily On/Off		
	On or Off		
	Mode		
	Activate		
	Daily Start/Stop		
	Start Time		
	Stop Time		
	Active Days		
	Cycle On/Off		
	Cycle Interval (Number of Days)		
	Cycle Start Time		

Control Panel Setup

Constants Screen 3				
Wind				
	Wind High Limit			
	On or Off			
AR/AS				
	On or Off			
	Delay in Seconds			
Percent Timer				
	Cycle in Seconds			
Low Voltage				
	Low Voltage Limit			
Dir Offset				
	Direction Offset			
Engine/Pump				
	Engine or Pump			
	Normal or Alt			
COM Port		9-Pin	25-Pin	9-Pin Y
	Protocol			
	Baud Rate			
	Hardware Flow Control			
	Key Wait			
	Config Notice			
	Base I.D.			
	Modem Type			
	Callout Tries			
	Radio Hop On or Off			
	Intermediate Unit ID			
	Phone Number			
	Notice On or Off			
	No Ack			

Constants Screen 4			
Pres Sensor			
	Pressure Sensor Type		
Backlight			
	Backlight Delay		
Cruise Control			
	Max % Change of Speed		
	Field Size in Degrees		
VRI Zone			
	Minimum App. Rate		
	Minimum Flow Rate		
	Maximum Pressure		
	# of Sprinkler Banks		
Tire Pres			
	Warning Pressure Drop		
	Shutdown Pressure Drop		
End Pres			
	TPMS ID		
	Sensor ID		





Control Panel Setup

Constants Screen 5			
Watering Timer			
	% Overwater Shutdown		
	% Underwater Error		
Temperature			
	Temperature Shutdown		
	Low Temp Limit		
Rain			
	Rain Shutdown		
	Rain Limit		
	Rain Window		



Run the Machine Wet (With Water)

1. ALWAYS make sure that vehicles, other equipment, livestock, and people are clear of the machine before operating.
2. Turn the control panel main disconnect switch to the ON position.

If the power is supplied by an engine-driven generator, adjust the RPM of the generator until the voltmeter reads 460 – 505 volts. DO NOT EXCEED 505 VOLTS.



3. Press .
4. Select direction of travel by pressing  or .
5. Press  or  to set the water application.

NOTE: WATER ON must be pressed before setting the water application rate or percent.

- Use  to set the water application by inches of water.
- Use  to set the water application by percent timer setting.

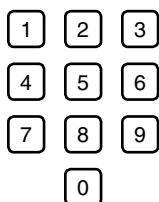
6. Use the NUMERIC keys to enter the depth of water in inches or the percent timer setting:







7. Press  to retain the value.
8. Press  to start the machine.
9. Press  to stop the machine.



Run the Machine Dry (Without Water)

1. ALWAYS make sure that vehicles, other equipment, livestock, and people are clear of the machine before operating.
2. Turn the control panel main disconnect switch to the ON position.

If the power is supplied by an engine-driven generator, adjust the RPM of the generator until the voltmeter reads the correct Nominal Supply Voltage for the machine.

3. Press .
4. Select direction of travel by pressing  or .
5. Set the speed of travel by pressing .

NOTE: WATER OFF must be pressed before setting the percent.

6. Use the numeric keys to enter percent timer setting.
7. Press  to retain the value.
8. Press  to start the machine.
9. Press  to stop the machine.

Operation

Stopping the Machine Emergency Stopping

To stop the machine in an emergency situation, shut off any one of the following switches. See Figure 46-1.

- Main service Disconnect Switch from public power to the control panel.
- Control panel main Disconnect Switch.
- Any tower box Disconnect Switch.

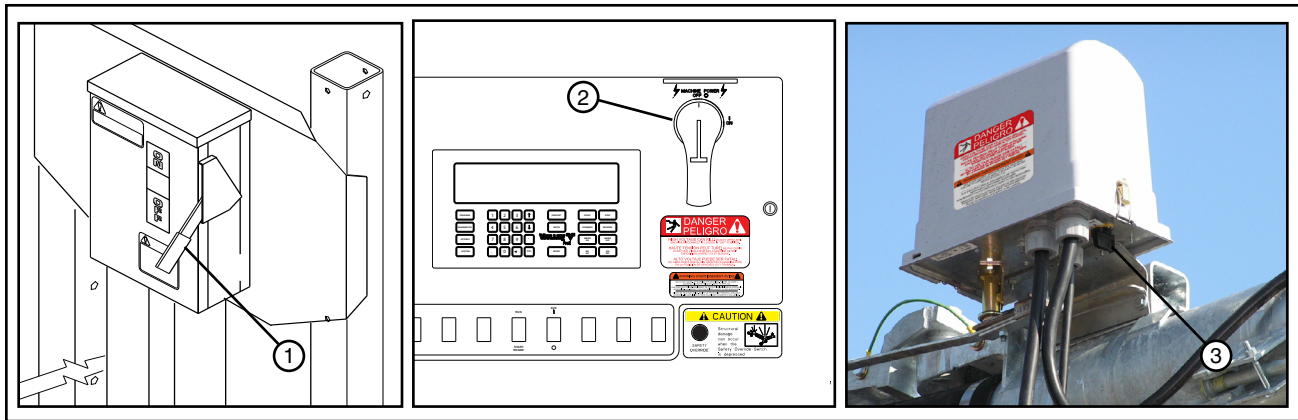

Figure 46-1 1. Main Service Disconnect Switch
2. Control Panel Main Disconnect Switch
3. Tower Box Disconnect Switch

Stopping Under Normal Conditions

1. Press the STOP key. See Figure 46-2.
2. Turn the main disconnect switch to the OFF position.
3. Turn the pumping unit OFF (if not automatic).
4. If an engine generator set is utilized, place the Engine Run/Start switch to the Start position for the next start-up sequence.

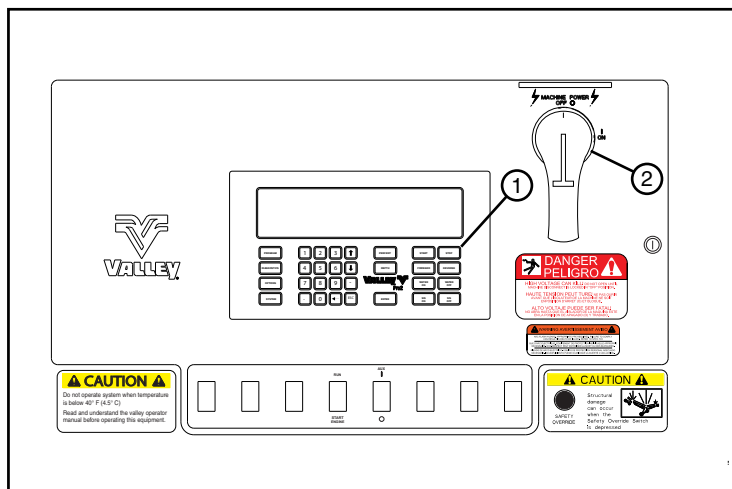

Figure 46-2 1. Stop Key
2. Main Disconnect Switch OFF

⚠ WARNING

- **DO NOT SHUT THE MACHINE OFF BY SLOWLY IDLING DOWN THE ENGINE GENERATOR SET. THIS PRACTICE CAUSES LOW VOLTAGE, AND WILL DAMAGE MACHINE COMPONENTS.**
- **ALWAYS STOP THE IRRIGATION MACHINE PRIOR TO SHUTTING DOWN THE ENGINE-GENERATOR SET.**

Diagnostics Screen

The Diagnostics section provides an overview of the use of the diagnostic features incorporated in the control panel. Diagnostics aid in identifying machine failures, troubleshooting, and correcting problems.

0 EXIT	3 CRUISE CTL	6 NA
1 SYSTEM FAULTS	4 VRI-Z DIAG	7 NA
2 ERROR LOG	5 PLC ERRORS	
PRESS NUMBER >		

Figure 47-1

1. Press  to view the Diagnostics screen. See Figure 47-1.

System Faults

System Faults are failures that shut the machine down. Any item showing FAULT on the system faults screen has caused the machine to shut down. The faults that can be indicated on the System Fault screen are shown in Figure 47-2. Refer to the Troubleshooting section for possible causes and corrective actions.



SYSTEM POWER FAULT	Voltage has fallen below the low voltage limit for more than 15 seconds, or power was lost while the machine was running.
SYSTEM SAFETY FAULT	Caused by a break in the safety return circuit that lasted longer than three seconds.
LOW PRESSURE FAULT	The pressure fell below the low pressure limit, or the Pressure Delay is not a sufficient amount of time to build pressure in the machine after it is started.
HIGH PRESSURE FAULT	With VRI-Zone on, the pressure went above the high pressure limit for more than three seconds.
WATER TIMER FAULT	The machine shut down because it was moving too slowly, thereby applying too much water.
COMMAND FAULT	The machine was commanded to stop by one of the following: 1) The STOP key was pressed. 2) An autostop condition occurred at the end-of-field stop. 3) A programmed STOP command was executed.
STOP-IN-SLOT (SIS) FAULT	The machine was shut down by the Stop-In-Slot.
PROGRAM FAULT	The machine was shut down because a Step program stopped the system.
AUTOSTOP FAULT	An autostop condition occurred at the end-of-field stop.
BBRAM FAULT	An attempt was made to start the machine when error E01 was displayed on the status screen.
FLOW FAULT	With VRI-Z on, the flow rate has fallen below the amount set in the FLOWMETER GAL/PULSE field.
FOR/REV FAULT	Both the forward and reverse sensor relays were on for more than 15 seconds while the system was running or waiting.
TIRE PRESSURE	Tire pressure shutdown was turned on and one or more tires had low pressure.
WIND FAULT	The machine shut down because the wind speed reached the high wind limit. The wind speed indicator is an option. WIND is only displayed on the system faults screen when wind is turned ON.
TEMPERATURE FAULT	The machine shut down because the temperature fell below the low temperature limit.
RAIN FAULT	The machine shut down because the rain limit was exceeded in the rain window time period.
DAILY OPS FAULT	The daily operations program shut the machine down because it is not allowed to run between a certain time period, DAILY OPS is only displayed on the system faults screen when Daily Ops is turned ON.
NO ACK	No Acknowledge is enabled and the BaseStation did not acknowledge the message.
RELAY COM FAULT	There is a hardware or software communication problem between the Pro2 module and the electrical relay board within the control panel.
GPS COM FAULT	When GPS is selected as a protocol and the system shuts down due to no communication with GPS for a user-specified amount of time, when shut down of GPS signal loss is ON, or while the system was running or waiting.
GPS LOCK FAULT	When GPS is selected as a protocol and the System shuts down due to GPS signal loss for a user-specified amount of time, or when shut down of GPS signal loss is ON, or while the system is running or waiting.
BOUNDARY FAULT	The machine shut down because it traveled beyond the forward or reverse Position angles.

Figure 47-2

Diagnostics

Viewing System Faults

System faults are displayed on the main screen and under Diagnostics. To view the System Faults screen under Diagnostics, do the following:

1. Press ,  to display the System Faults screen. See Figure 48-1.

When a recognized fault causes the machine to shut down, FAULT is displayed next to the item responsible for the shutdown.

FAULT is automatically cleared the next time the machine is run successfully.

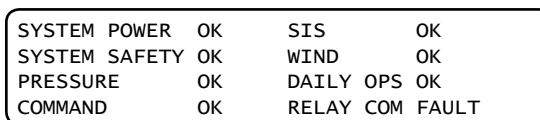

SYSTEM POWER	OK	SIS	OK
SYSTEM SAFETY	OK	WIND	OK
PRESSURE	OK	DAILY OPS	OK
COMMAND	OK	RELAY COM	FAULT

Figure 48-1

Status Screen Diagnostics

If a failure occurs, an error code appears on the status screen. If more than one error has occurred, the errors that have occurred will sequence between each other every second. See Figure 48-2.

NOTE: Viewing the error log screen clears the error codes from the Status screen.







03:00:00		180.0 DEG RUNNING
06/12/14		33. .PSI FORWARD
477 VOLTS	E05	50.0 % WATER. ON
48.0 HR		0.50 IN SIS= OFF

Figure 48-2 1. Error Code

Clearing an Error Code

To view and clear an error code from the status screen, do the following:

1. Press , and  to display the Error Log screen. See Figure 48-3.
2. Press  and Search backward to view an error code. Viewing an error code clears the error code from the status screen.

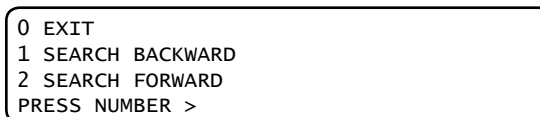

0	EXIT
1	SEARCH BACKWARD
2	SEARCH FORWARD
	PRESS NUMBER >

Figure 48-3

Error Codes

A list of possible error codes is shown in the table below. Refer to the Troubleshooting section for possible causes and corrective action.

ERROR CODES	DESCRIPTION
E01	BGRAM - Checksum failed at power up.
E02	EEPROM - Checksum failed at power up.
E03	UNIT RESETS - This is logged when the software resets.
E04	POWER DROP - Power dropped below low voltage limit.
E05	SYSTEM SAFETY - Possible tower misalignment, drive unit may be stuck.
E06	PUMP SAFETY - Pressure too low after pressure delay.
E07	PRESSURE SENSOR - Out of range high, check connection.
E08	PRESSURE SENSOR - Out of range low, check connection.
E09	PRESSURE SENSOR - Pressure high with pump off, check connection.
E10	PRESSURE SENSOR - Mechanical switch could be stuck.
E11	RESOLVER - Angle jumping around. Lube J pipe.
E12	E12 RESOLVER - Out of range high, check for loose or shorted wires.
E13	KEYPAD - Possible key stuck, check keypad connection.
E14	FWD/REV SENSE - Possible short, check wiring.
E15	UNDERWATER ERROR - Check for induced voltages and % timer connections.
E16	NOT AVAILABLE
E17	NOT AVAILABLE
E18	GPS communications error, check GPS connection and power.
E19	GPS SIGNAL LOSS, check for clear path above antenna.
E20	DGPS SIGNAL LOSS, check for clear path above antenna.
E21	LOW FLOW
E22	HIGH PRESSURE
E23	PLC COMMUNICATIONS ERROR. (GPS V2 Only)
E24	RESYNC valve duty cycle due to pressure.
E25	GPS COORDINATES OUT OF RANGE, check distance to GPS or for crosstalk.
E26	LOW TIRE PRESSURE
E27	TPMS COMMUNICATIONS ERROR

Diagnostics

Error Logs

For each error code there is an error log.

When an error occurs, information about the error, including the first time and date, last time and date, and total count of all times that the error occurred is recorded in the error log. See Figure 50-1.

Viewing an Error Log

To view an Error Log, do the following:

1. Press **DIAGNOSTICS**, **2**, **1** to display the E01 Error Log screen. See Figure 50-2.

NOTE: Viewing the error log screen clears the error codes from the Status screen.

2. Locate the desired error log:
 - Press **1** to search backward through the Error Logs.
 - Press **2** to search forward through the Error Logs.
3. Press **ESC** to return to the menu. Press **ESC** a second time to return to the main panel display.

Resetting an Error Log to Zero

To reset an Error Log to zero, do the following:

1. Press **DIAGNOSTICS**, **2**, **1** to display the E01 Error Log screen. See Figure 50-3.
2. Locate the desired error log screen to reset. See Figure 50-4.
 - Press **1** to search backward through the Error Logs.
 - Press **2** to search forward through the Error Logs.
3. Press **←** two times.

The count is reset to zero and the first and last occurrences are set to the current time and date. See Figure 50-5.

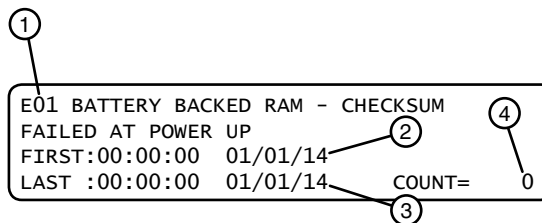

Figure 50-1 1. Error Code
2. First Occurrence Time and Date
3. Last Occurrence Time and Date
4. Total Occurrences

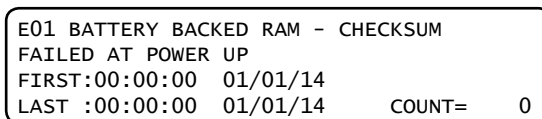

Figure 50-2

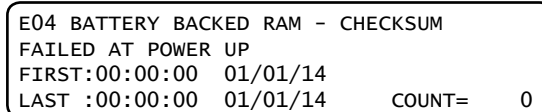

Figure 50-3

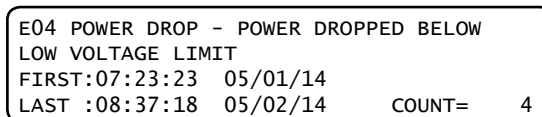

Figure 50-4 Selected Error Log

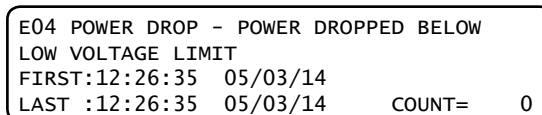

Figure 50-5

Use this Troubleshooting section with the machine owner's manual to diagnose and troubleshoot problems with the machine and/or control panel.

Always perform service or maintenance safely, use personal protection equipment when required, maintain a minimum working clearance around the control panel and other equipment, use fall protection when required, and always use at least the minimal lockout/tagout procedure when maintaining or servicing the machine. For more information refer to the Safety section.

WARNING

TO REDUCE THE POSSIBILITY OF SEVERE INJURY OR DEATH:

- **TROUBLESHOOTING OR REPAIRING ELECTRICAL PROBLEMS SHOULD ONLY BE PERFORMED BY A QUALIFIED VALLEY DEALER.**
- **ALWAYS CONTACT YOUR LOCAL VALLEY DEALER TO TROUBLESHOOT OR CORRECT ANY ELECTRICAL PROBLEMS ON OR ASSOCIATED WITH THE CONTROL PANEL OR MACHINE. NEVER ATTEMPT TO TROUBLESHOOT OR CORRECT ELECTRICAL PROBLEMS ON YOUR OWN.**
- **USE PERSONAL PROTECTION EQUIPMENT WHEN REQUIRED.**
- **MAINTAIN A MINIMUM WORKING DISTANCE AROUND THE CONTROL PANEL AND OTHER EQUIPMENT.**
- **USE FALL PROTECTION WHEN REQUIRED.**
- **BEFORE SERVICING OR PERFORMING MAINTENANCE ON THE MACHINE, ALWAYS SHUT OFF ALL ELECTRICAL POWER TO THE CONTROL PANEL AND MACHINE, THEN, USE THE MINIMAL LOCKOUT/TAGOUT PROCEDURE ON THE SERVICE DISCONNECT AND CONTROL PANEL.**

Troubleshooting

System Faults

Listed below are the possible system faults with the description, possible causes, whether the machine will shut down if the error occurs, and corrective action to take. See Figures 52-1 and 53-1.

SYSTEM FAULT	DESCRIPTION WITH POSSIBLE CAUSES	SHUT DOWN	CORRECTIVE ACTION
SYSTEM POWER FAULT	Voltage has fallen below the low voltage limit for more than 15 seconds, or power was lost while the machine was running.	YES	Check Low Voltage Limit for correct value. Contact your Valley dealer.
SYSTEM SAFETY FAULT	Caused by a break in the safety return circuit for more than three seconds.	YES - if more than 3 seconds	Make sure a tower is NOT stuck. Check for flat tire on a tower. Check for wheel gearbox failure. Check End-Of-Field Stop for proper operation. Contact your Valley dealer.
LOW PRESSURE FAULT	The pressure fell below the low pressure limit for more than thirty seconds, or the pressure delay is not a sufficient amount of time to build pressure in the machine after it is started.	YES - if more than 30 seconds	Make sure pump is on. Set Low Pressure Limit higher. Set Pressure Delay for longer period of time. Contact your Valley dealer.
HIGH PRESSURE FAULT	With VRI-Zone on, the pressure went above the high pressure limit for more than three seconds.	YES - if more than 3 seconds	
WATER TIMER FAULT	The machine shut down because it was moving too slowly, thereby applying too much water.	YES	
COMMAND FAULT	The machine was intentionally commanded to stop by one of the following: 1) The stop key was pressed. 2) An autostop condition occurred at the end-of-field stop. 3) A programmed stop command was executed.	YES	Normal operation - No corrective action needed.
STOP-IN-SLOT (SIS) FAULT	The machine was shut down by the Stop-In-Slot.	YES	Normal operation - No corrective action needed. If desired, program a different Stop-In-Slot location.
PROGRAM FAULT	The machine was shut down because a Step program stopped the system.	YES	
AUTOSTOP FAULT	An autostop condition occurred at the end-of-field stop.	YES	Normal operation - No corrective action needed.
BBRAM FAULT	Indicates that an attempt was made to start the machine when Error E01 was displayed on the status screen.	YES	Contact your Valley dealer. Clear by viewing Diagnostics/System Fault when BBRAM is present.
FLOW FAULT	With VRI-Z on, the flow rate has fallen below the amount set in the FLOWMETER GAL/PULSE field.	YES	Examine the VRI-Z prescription to determine why so many sprinklers are turned off. Revise prescription.
FOR/REV FAULT	Both the forward and reverse sense relays were on for more than 15 seconds while the system was running or waiting.	YES	Contact your Valley dealer. Fault cleared when the system attempts to run.
TIRE PRES FAULT	Tire pressure shutdown was turned on and one or more tires had low pressure.	YES Tire Pressure Shut Down option must be enabled	Tire pressure is at or lower than the tire pressure shutdown value. View error E26 to determine which tower has a tire with low pressure. Check the tires on the tower for low pressure, and repair as needed. Contact your Valley dealer.

Figure 52-1

System Faults (continued)

SYSTEM FAULT	DESCRIPTION WITH POSSIBLE CAUSES	SHUT DOWN	CORRECTIVE ACTION
WIND FAULT	The machine shut down because the wind speed reached the high wind limit. The wind speed indicator is an option. WIND is only displayed on the system faults screen when wind is turned ON.	YES	Normal operation - No corrective action needed.
TEMPERATURE FAULT	The machine shut down because the temperature fell below the low temperature limit.	YES	Restart the machine when the temperature rises above the limit.
RAIN FAULT	The machine shut down because the rain limit was exceeded in the rain window time period.	YES	
DAILY OPS FAULT	The daily operations program shut the machine down because it is not allowed to run between a certain time period, DAILY OPS is only displayed on the system faults screen when Daily Ops is turned ON.	YES	Normal operation - No corrective action needed. If desired, reprogram Daily OPS to run at a different time or turn Daily OPS OFF.
NO ACK FAULT	No Acknowledgement was received from communication device while machine was running. Notice must be ON with No Ack set to Shut Down.	YES	Check communication devices for proper operation.
RELAY COM FAULT	There is a hardware or software communication problem between the Pro2 module and the electrical relay board within the control panel.	YES	Contact your Valley dealer.
GPS COM FAULT	While system was running or waiting, all of the following must have occurred: 1. GPS is selected as a protocol. 2. GPS signal loss is set to shut down the machine. 3. The machine shut down due to no communication with the GPS for a user specified time.	YES	Check the GPS connection and the power. Contact your Valley dealer.
GPS LOCK FAULT	While system was running or waiting, all of the following must have occurred: 1. GPS is selected as a protocol. 2. GPS signal loss is set to shut down the machine. 3. The machine shut down due to GPS signal loss for a user specified time.	YES	Check for a clear path above the antenna. Contact your Valley dealer.
BOUNDARY FAULT	The machine shut down because it traveled beyond the forward or reverse Position angles.	YES	Walk the machine back. Check the For/Rev Position angles. Contact your Valley dealer.

Figure 53-1

Troubleshooting

Error Codes

Listed below are the possible error codes with the description, threshold for the error to occur, whether the machine will shut down if the error occurs, and possible causes or corrective action to take. See Figures 54-2 through 56-1.

Error Codes

ERROR	DESCRIPTION	THRESHOLD	SYSTEM FAULT SHUT DOWN	POSSIBLE CAUSES or CORRECTIVE ACTION	SHOWN ON SCREEN
E01	BGRAM - BATTERY BACKED RAM CHECKSUM FAILED AT POWER UP.		YES	Contact your Valley dealer.	YES
E02	EEPROM - CHECKSUM FAILED AT POWER UP.	One of the blocks failed.	YES	This error can occur when power is lost while entering constants. Data being entered may be lost. Try to hard reset module. Contact your Valley dealer.	YES
E03	UNIT RESETS - THIS IS LOGGED WHEN THE SOFTWARE RESETS.	Every time the software is power cycled.	NO	Records every time the module is power cycled. Normal operation. No corrective action.	NO
E04	POWER DROP - POWER DROPPED BELOW LOW VOLTAGE LIMIT.	If running/waiting, and voltage drops below low voltage.	YES - after 15 seconds.	This error occurs when the voltage drops below the low voltage limit. Nuisance shutdowns can be caused by setting the Low Voltage Limit too high. Contact your Valley dealer.	YES
E05	SYSTEM SAFETY - POSSIBLE TOWER MISALIGNMENT, DRIVE UNIT MAY BE STUCK.	Safety lost while running.	YES - after 3 seconds.	This error occurs when the safety circuit is open due to misaligned towers, guidance problems, over-watering timer timed out, or any other component in the safety circuit. Contact Your Valley Dealer.	YES
E06	PUMP SAFETY - PRESSURE TOO LOW AFTER PRESSURE DELAY.	Pressure with pump off.	YES - until started.	This error may occur when the pressure delay time or the low pressure setting are not correct. The pump, pressure transducer, or pressure switch may have failed Low pressure set point too close to operating pressure. Contact your Valley dealer.	YES
E07	PRESSURE SENSOR - OUT OF RANGE HIGH, CHECK CONNECTION.	> 4.5 volts.	NO	This error occurs when the pressure transducer has failed. Contact your Valley dealer.	YES
E08	PRESSURE SENSOR - OUT OF RANGE LOW, CHECK CONNECTION.	< 0.5 volts.	NO	This error may occur when the pressure transducer has failed or is not installed. Contact your Valley dealer.	YES
E09	PRESSURE SENSOR - PRESSURE HIGH WITH PUMP OFF, CHECK CONNECTION.	Pump off for 5 min., and more then 7 PSI (0.5 bar)	NO	This error may occur when the pressure transducer has failed or water is still in riser pipe because a machine drain may be plugged. Re-calibrate pressure transducer. Contact your Valley dealer.	YES

Figure 54-1

Error Codes (continued)

ERROR	DESCRIPTION	THRESHOLD	SYSTEM FAULT SHUT DOWN	POSSIBLE CAUSES or CORRECTIVE ACTION	SHOWN ON SCREEN
E10	PRESSURE SENSOR - MECHANICAL SWITCH COULD BE STUCK.	Pump off for 5 min, and switch still on.	NO	This error may occur if the pressure transducer or switch has failed or is stuck. Contact your Valley dealer.	YES
E11	RESOLVER - ANGLE JUMPING AROUND, LUBE J PIPE.	5° jump in 1 second (twice).	NO	This error may occur if the pivot swivel is binding or sticking, and requires lubrication.	YES
				J-tube overtightened or seized.	
				Pipe not secured to H-bracket.	
				Collector ring loose. Contact your Valley dealer.	
E12	RESOLVER - OUT OF RANGE HIGH, CHECK FOR LOOSE OR SHORTED WIRES.	X AND Y = 2.5 volts.	NO	This error may occur if the resolver wires are loose or shorted. Contact your Valley dealer.	YES
E13	KEYPAD - POSSIBLE KEY STUCK CHECK KEYPAD CONNECTION.	10 seconds.	NO	This error may occur if the key pad has failed or a key is stuck.. Contact your Valley dealer.	YES
E14	FWD/REV SENSE - POSSIBLE SHORT, CHECK WIRING.	2 seconds.	YES - after 15 seconds.	When this error is detected, both the forward and reverse run lines are powered. The machine status will show running when AR/AS is OFF even though the motor contactor is disabled. The machine will stop if AR/AS is ON and Auto Stop is selected. If AR/AS is ON and Auto Reverse is selected, the machine will alternate between forward and reverse direction control. Since motor power is disabled until the direction has locked in, the machine will not move. Contact your Valley dealer.	YES
E15	UNDERWATER ERROR - MACHINE MAY BE MOVING TOO FAST.	Number of minutes as set in the % UNDERWATER ERROR field.	NO	Check for induced voltages and Percent Timer connections.	YES
E16	NOT ASSIGNED			This error code is not assigned.	
E17	NOT ASSIGNED			This error code is not assigned.	
E18	GPS COMMUNICATION ERROR, CHECK GPS CONNECTION AND POWER.	10 seconds.	YES, if Shut Down System is selected.	This error occurs when GPS is selected as a protocol, and a transition occurs from communications to no communications for 10 seconds.	NO, position will flash.
				Check GPS connection.	
				When GPS option is powered by safety circuit, a loss of power will cause this error.	

Figure 55-1

Troubleshooting

Error Codes (continued)

ERROR	DESCRIPTION	THRESHOLD	SYSTEM FAULT SHUT DOWN	POSSIBLE CAUSES or CORRECTIVE ACTION	SHOWN ON SCREEN
E19	GPS SIGNAL LOSS, CHECK FOR CLEAR PATH ABOVE ANTENNA. Position of machine will flash when error occurs.	10 seconds.	YES, if Shut Down System is selected.	This error occurs when the signal from the GPS transitions from GPS Lock to GPS Unlock. Check for clear path above the antenna.	NO, position will flash.
E20	DGPS SIGNAL LOSS, CHECK FOR CLEAR PATH ABOVE ANTENNA.	10 seconds.	NO	This error occurs when the signal from the DGPS transitions from DGPS to Standard. Check for clear path above the antenna.	NO
E21	LOW FLOW	Minimum flow rate is enabled, and the machine water pressure is above the low pressure setting	YES,	A Low Flow error can only occur if the constant's Minimum Flow Rate is enabled, and the machine water pressure is above the low pressure setting.	YES
E22	HIGH PRESSURE	3 Seconds		A High Pressure error occurs if the machine water pressure reaches the constant's Maximum Pressure setting for 3 seconds.	YES
E23	PLC COMMUNICATIONS ERROR. (GPS V2 Only)	3 Times in a Row.	NO	This error occurs when a PLC with GPS V2 does not reply to control panel messages three times in a row. Verify Correct PLC Channel and ID Settings.	YES
E24	RESYNC VALVE DUTY CYCLE DUE TO PRESSURE	Pressure reaches the constant's valve resync water pressure setting		A Resync Valve Duty Cycle error is recorded if the machine water pressure reaches the constant's Valve Resync Water Pressure setting.	YES
E25	GPS COORDINATES OUT OF RANGE, CHECK DISTANCE TO GPS OR FOR CROSSTALK.	When GPS coordinates go out of range	YES, if Shut Down System is selected.	This error occurs when: The distance from the pivot to the GPS receiver is outside of the set length \pm - Set correct distance to GPS. The pivot point coordinates are incorrect - Set pivot point to correct coordinates. There is crosstalk from another GPS device on the same channel - Change GPS PLC to different channel to avoid crosstalk.	YES
E26	LOW TIRE PRESSURE	Records every occurrence on one tower	NO	A tire with pressure at or below the tire pressure warning value is on the indicated tower. The error and the number of occurrences are logged for only one tower at a time. If the error is already logged on a tower, errors on a different tower will not be logged. Correct the problem and clear the error to log other occurrences.	YES
E27	TPMS COMMUNICATIONS ERROR	3 Failed Attempts in a Row	NO	A particular TPMS ID did not reply to control panel messages 3 times in a row.	YES

Figure 56-1

Troubleshooting List

Listed below and on the next page are various descriptions of problems, their possible causes, and corrective action to take. See Figure 57-1 below and Figure 58-1 on the next page.

PROBLEM	POSSIBLE CAUSE OR CORRECTIVE ACTION
RESOLVER POSITION IS NOT ACCURATE.	PIVOT POINT BINDING.
	J-TUBE OVERTIGHTENED OR SEIZED.
	PIPE NOT SECURED TO H-BRACKET.
	COLLECTOR RING LOOSE.
	DIRECTION OFFSET INCORRECT.
	CONTACT YOUR VALLEY DEALER.
PIVOT AUTO REVERSES RANDOMLY.	CONTACT YOUR VALLEY DEALER.
PIVOT AUTO STOPS RANDOMLY.	CONTACT YOUR VALLEY DEALER.
PIVOT BREAKS SAFETY AT BARRICADE.	BARRICADE TOO HIGH ON ACTUATOR ARM.
	AUTO REVERSE/AUTO STOP DISABLED.
	AUTO REVERSE/AUTO STOP BOX NOT ADJUSTED CORRECTLY.
	CONTACT YOUR VALLEY DEALER.
PRESSURE TRANSDUCER READING INCORRECT.	CALIBRATE WITHOUT WATER.
	CHECK VALVE HOLDING WATER IN RISER.
	TRANSDUCER HAS ICE AGAINST SENSOR.
	TRANSDUCER PLUGGED.
	PRESSURE TUBE PLUGGED OR DAMAGED.
	CONTACT YOUR VALLEY DEALER.
NO DISPLAY.	CONTRAST ADJUSTED TOO LIGHT OR DARK.
	DISCONNECT SWITCH OFF.
	NO POWER TO PIVOT.
	CONTACT YOUR VALLEY DEALER.
END GUN DOES NOT SHUT OFF.	INCORRECT END GUN ENTRY.
	FILTER PLUGGED.
	DEFECTIVE END GUN HARDWARE.
	DIRECTION OFFSET INCORRECT; ARC TOO SMALL.
	CONTACT YOUR VALLEY DEALER.
END GUN DOES NOT TURN ON.	END GUN CONSTANTS NOT PROGRAMMED CORRECTLY.
	END GUN OPTIONS SET TO DISABLE.
	DEFECTIVE END GUN HARDWARE.
	CONTACT YOUR VALLEY DEALER.
SCREEN CYCLES ON AND OFF.	ERRATIC INCOMING POWER.
	LOW VOLTAGE.
	CONTACT YOUR VALLEY DEALER.

Figure 57-1

Troubleshooting

Troubleshooting List (continued)

PROBLEM	POSSIBLE CAUSE OR CORRECTIVE ACTION
DOES NOT STOP AT SIS.	SIS NOT TURNED ON.
	SIS POSITION HAS BEEN CHANGED.
	MACHINE MUST MOVE AT LEAST 2° AWAY FROM THE SIS POSITION BEFORE IT CAN BE STOPPED AGAIN BY SIS.
	CONTACT YOUR VALLEY DEALER.
BACKLIGHT DOES NOT TURN ON.	CONTACT YOUR VALLEY DEALER.
BACKLIGHTING DOES NOT TURN OFF.	INCORRECT CONSTANT ENTERED.
	CONTACT YOUR VALLEY DEALER.
SCREEN DARK.	CONTRAST SET TOO HIGH OR LOW.
	CONTACT YOUR VALLEY DEALER.
PIVOT WON'T AUTO RESTART.	START\$ PROGRAM WRITTEN INCORRECTLY OR MISSING.
	RESTART CRITERIA HAS NOT BEEN MET.
	OFF DAY IN DAILY OPS.
	SYSTEM FAULT OTHER THAN POWER OR PRESSURE.
	CONTACT YOUR VALLEY DEALER.
PIVOT WON'T STOP WITH DAILY OPS.	START/STOP TIMES REVERSED.
	DAILY OPS NOT ACTIVE.
	A PROGRAM OTHER THAN DAILY OPS STARTS MACHINE.
	CONTACT YOUR VALLEY DEALER.
AUTO RESTART DOES NOT WORK	MAKE SURE A START\$ IS ENTERED.
	SYSTEM FAULT MUST BE EITHER POWER OR PRESSURE FOR RESTART TO WORK.
	VERIFY THAT AUTO RESTART IS TURNED ON.
	CONTACT YOUR VALLEY DEALER.

Figure 58-1

Hard Reset

A hard reset resets the Electrically Erasable Programmable Read-Only Memory (EEPROM).

- Resets current status to factory settings.
- Restores all constants to factory settings.
- Restores all options to factory settings.
- Erases all current and stored programs.
- Clears Review History.
- Clears Error Log history.

Executing a Hard Reset

To execute a hard reset, follow the steps below:

1. Record all options settings, constants settings, and programs that will need to be reentered after the hard reset.
2. Turn the control panel disconnect to OFF.
3. While turning the control panel disconnect ON, press and hold  until the Reset screen is displayed. See Figure 59-1.
4. Select one of the following:

 = RESET

 = SKIP the reset function.

If RESET is selected, a status message is displayed. See Figure 59-2

If no selection is made within 60 seconds, the reset will be skipped.

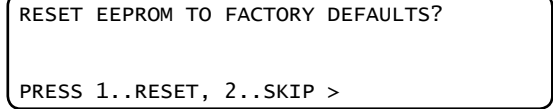

```
RESET EEPROM TO FACTORY DEFAULTS?  
PRESS 1..RESET, 2..SKIP >
```

Figure 59-1

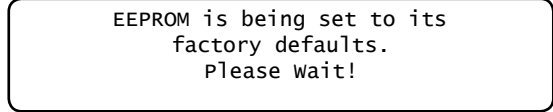

```
EEPROM is being set to its  
factory defaults.  
Please wait!
```

Figure 59-2

Troubleshooting

Advanced Features

Shown below are the Advanced Features associated with the Program, Diagnostic, Options, and System buttons.

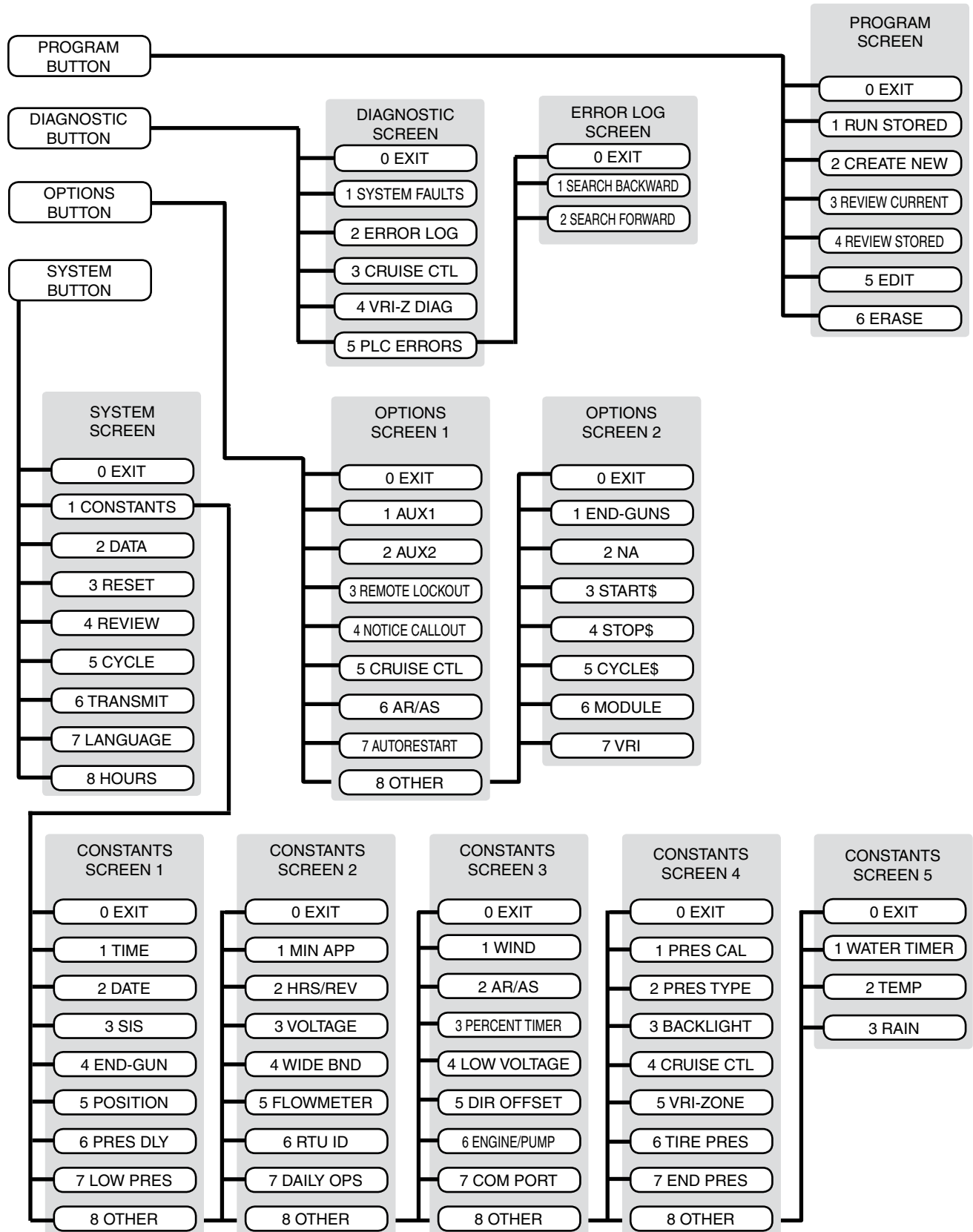

Advanced Features
