



**Valley Select2
Control Panel**

Advanced Features Manual

Software Version 2.00

0998905_A



Valley Select2 Control Panel

Valley Select2 Control Panel

Table of Contents

About This Manual	5
Ancillary Equipment Warranty	5
Setup Groups	7
Setup Mode Buttons	8
Setup Group 1 - Options.....	9
Stop-In-Slot	9
Forward and Reverse Positions	9
Forward Position	10
Reverse Position	10
Variable Rate Irrigation Speed Control (VRI-S).....	11
Enabling and Disabling VRI-S.....	11
Position Values.....	11
Adjustments	11
Control Panel Display	12
Irrigation Prescription.....	12
Downloading Prescription.....	12
End Gun	13
Typical Pivot End Gun Settings	13
End Gun Settings Table	13
Setting End Gun	14
Wide Boundary.....	15
Setup Group 2 - Programs	17
Sector Programs (1-9).....	17
Program On/Off	17
Left Angle	17
Direction.....	18
Water On/Off.....	18
Right Angle	19
Overlapping Programs.....	19
Setup Group 3 - Timers	21
Startup Pressure Delay	21
Operating Pressure Delay	22
Power and/or Pressure Restart Delay.....	22
Auto Reverse/Auto Stop Delay.....	23
Percent Timer Cycle.....	23
Setup Group 4 - Constants.....	25
Minimum Application	25
Low Hours Per Revolution.....	25
Low Pressure	25
Voltage Calibration.....	26
Low Voltage.....	26

Valley Select2 Control Panel

Table of Contents

Setup Groups (continued)	27
Setup Group 4 - Constants (continued).....	27
Auto Reverse/Auto Stop (AR/AS) Options	27
Option I - Drive Unit Mounted AR/AS	27
Option II - Operator Programmed AR/AS	27
Auto Reverse/Auto Stop (AR/AS).....	28
Current Position.....	28
Resolver Direction Offset	29
Resolver Position Accuracy	29
Estimated Direction Offset.....	30
Calculating The Direction Offset	31
Entering The Direction Offset	33
Engine Control Pump/Engine/Alt Engine	33
Auto Restart Both/Pressure/Power	34
Auto Restart Both	34
Auto Restart Pressure	34
Auto Restart Power.....	34
Flowmeter.....	35
Flowmeter Gallons or Liters per Pulse	35
English or Metric Units	36
Language	36
Setup Group 5 - Communications	37
Baud 9-Pin.....	37
Protocol 9-Pin.....	37
Baud 25-Pin.....	38
Protocol 25-Pin.....	38
RTU ID	38
Setup Group 6 - Error Codes.....	39
Viewing or Clearing An Error Code	39
Error Codes.....	39
Setup Group 7 - Time/Date	43
Setting Time and Date.....	43
Setup Group 8 - GPS	45
Current Latitude.....	45
Current Longitude.....	45
Satellites.....	45
Pivot Point	46
Review	46
Edit.....	47
Set	48
Fallback Position.....	48
Machine Length.....	48
Machine Speed	49
GPS Distance.....	49
GPS Distance Length -.....	49
GPS Distance Length +.....	49
Shutdown System Timer	50
Disable End guns Timer	50
GPS Loss Shutdown	51
Programming	53
Designing Programs	53
Program Example 1 (Full Circle, Two Sectors)	55
Program Example 2 (Half Circle, Two Sectors).....	57
Program Example 3 (Half Circle, Five Sectors)	59
Appendix	63
Setup Record Forms	63
Program Design Forms	65

About This Manual

Information contained in this manual applies to all Valley Select2 Control Panels with software version 2.00.

Specifications, descriptions, and illustrative material contained herein were as accurate as known at the time this publication was approved for printing.

Valmont Industries Inc., reserves the right to change specification or design without incurring obligation. Specifications are applicable to machines sold in the United States and may vary outside the United States.

Additional information is contained within the Valley Select2 Control Panel Owner's Manual, Part Number 0998903 (English).

Ancillary Equipment Warranty

The owner is responsible for warranty registration of all ancillary equipment such as engines, pumps, and generators with its respective manufacturer.

Valley Select2 Control Panel

Valley Select2 Control Panel

Setup Groups

This section describes the setup groups and the values within each group.

Setting up the control panel when it is initially installed requires entering the values which are unique to the machine and the individual field. These values can be recorded in a Setup Record form. Blank Setup Record forms are available in the Appendix of this manual and/or in the Valley Select2 Control Panel Owner's Manual.

Listed below are different setup groups:

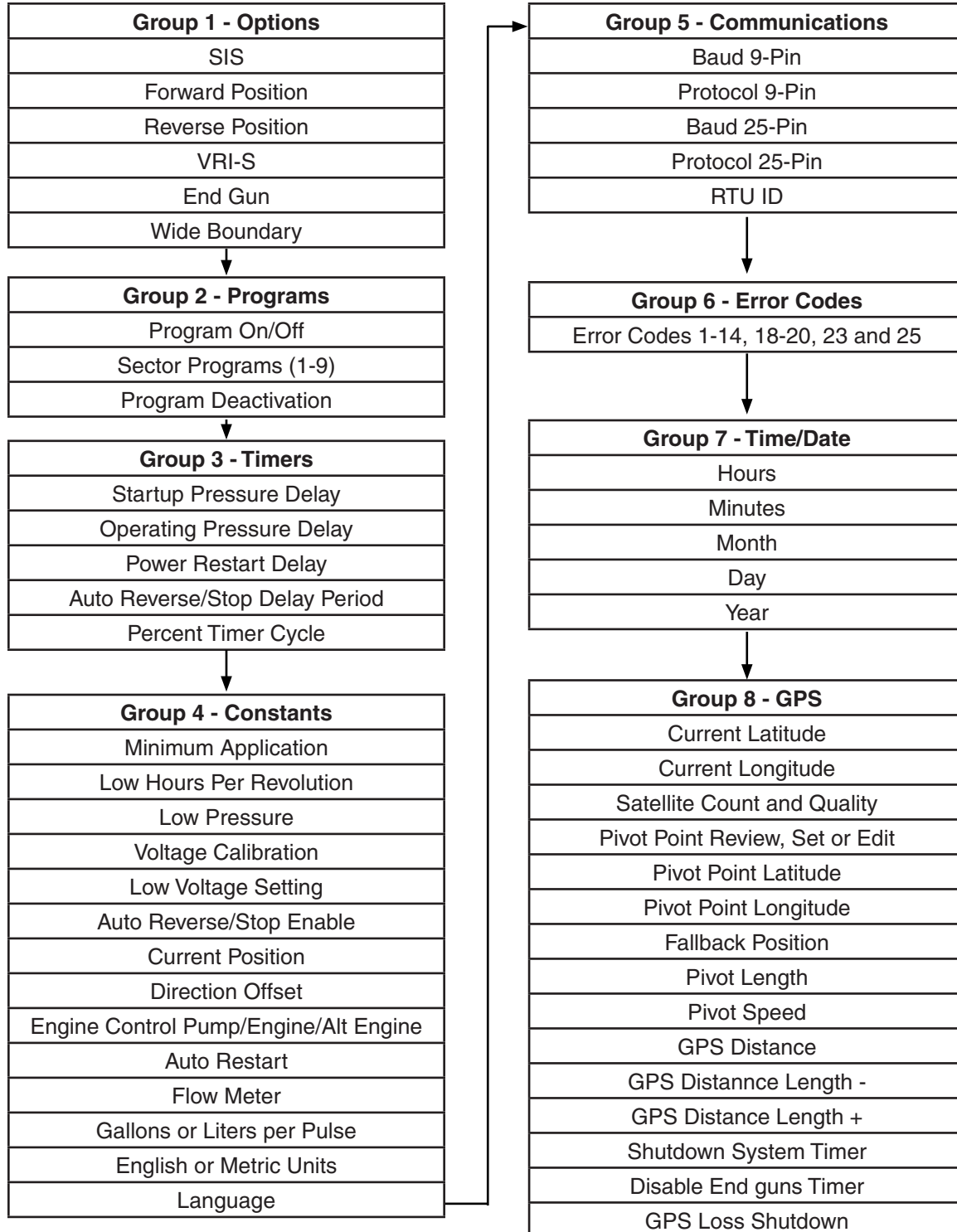

Valley Select2 Control Panel

Setup Groups

Setup Mode Buttons

Setup Button



From the main screen, use the SETUP button to access any setup group. Press and hold the SETUP button until the desired setup group is displayed or press the SETUP button the same number of times as the setup group number. Pressing the SETUP button while in any setup group will advance the operator to the next setup group. Any changes made will be saved.

- Example: to access setup group 4 - press and hold the SETUP button until GROUP 4 is displayed or press the SETUP button four times.

Application Depth Buttons



The APPLICATION DEPTH buttons are used to set values in the setup groups. Holding either of the buttons longer will advance the values at a faster rate.

NOTE

- When values are set or changed the new value is automatically saved. There is no confirmation or button click to save information.

Select Button



Pressing the SELECT button will advance the operator to the next value in the setup group. Any changes made will be saved.

Information Button



Pressing the INFORMATION button while in any of the setup groups will return the operator to the main screen and normal operating mode. Any changes made will be saved.

NOTE

- While in the Setup Mode, if the SELECT, SETUP, or an Application Depth button is not pushed within 60 seconds, the screen will return to the main screen. Any changes made will be saved.

Valley Select2 Control Panel

Setup

Setup Group 1 - Options

The following values can be set within setup group 1:

- Stop In Slot, • Forward Position, • Reverse Position, • End Gun, • Wide Boundary

1. From the main screen, press and hold **SETUP** until GROUP 1 is displayed or press **SETUP** one time.
2. GROUP 1 will be shown in the display screen. See figure 9-1.
 - Pressing **SELECT** advances the operator to the next value in the setup group. Any changes made will be saved.
 - Pressing **i** at any time within setup group will return the operator to the main screen. Any changes made will be saved.
 - Pressing **SETUP** at any time within the setup group will advance the operator to the next setup group. Any changes made will be saved.

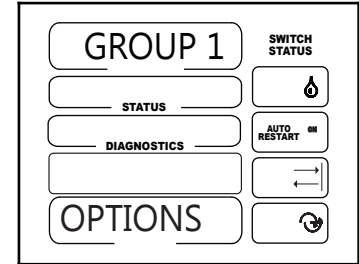

Figure 9-1

Stop-In-Slot

Stop-in-slot allows the operator to stop the machine at a set position such as a field road. If the stop in slot feature is on, the machine will stop at this position every time. Range is 0.0° - 359.9° and default is 0°. See figure 9-2.

1. S-I-S should be flashing. See figure 9-2.
2. Press **+** or **-** to change the value. This position can be set to the nearest tenth of a degree.
3. Press **SELECT** to view the next value in the setup group.

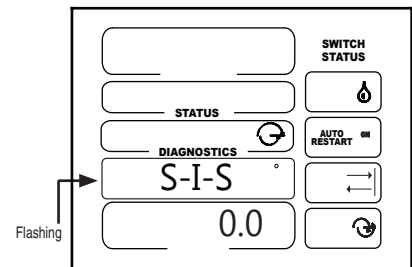

Figure 9-2

NOTE

- If a machine shuts down because SIS is on, the SIS does not need to be turned off before starting the machine again. The SIS feature will disengage for 2° of pivot travel, then re-engage so that the machine will shut down again when it reaches the SIS position.

Forward and Reverse Positions

The forward and reverse positions can be used when auto reverse/auto stop (setup group 4) are enabled to provide operator programmed AR/AS. Position values are set only if the pivot needs to reverse or stop in a typical full circle open field situation where there are not any physical obstacles such as part circle end of field, a tree line, building, grain bin, etc. A typical situation is illustrated in figure 9-3. The operator only wants to apply water to the South half of the field which is in corn. In this situation, the Select2 panel allows the operator to input:

- **Forward Position (left):** position (in degrees) where the machine changes direction from reverse to forward. The forward value of 90° will cause the machine to change the direction to forward at 90°.
- **Reverse Position (right):** position (in degrees) where the machine changes direction from forward to reverse. The reverse value of 270° will cause the machine to change the direction to reverse at 270°.
- The auto reverse and auto stop switches determine if the machine will change direction of travel at the programmed position(s) or stop.

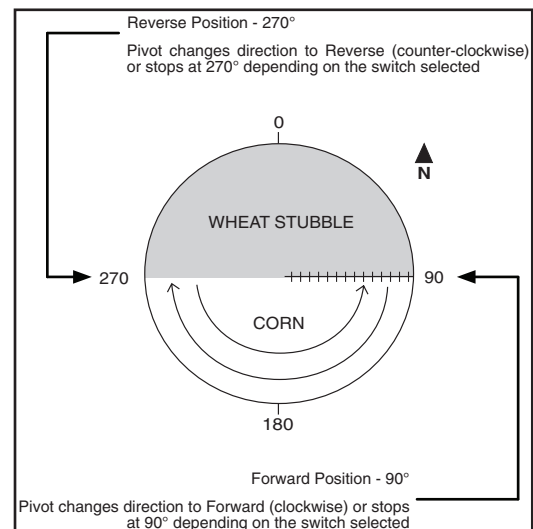

Figure 9-1

Valley Select2 Control Panel

Setup

Setup Group 1 - Options

Forward and Reverse Positions (continued)

The forward and reverse positions can be disabled by either turning the auto reverse/stop feature off or setting both the forward and reverse positions to the same value. For example, setting the forward and reverse positions both to 0.0° will disable the operator programmed AR/AS feature.

If the machine is located outside of the area of travel as defined by the forward and reverse positions, then the machine will not be allowed to start. See figure 10-1

For example, if the area of travel is between a forward position of 90° and a reverse position of 270° and the machine's current position is 45°, the machine is out side of the area of travel and would not be allowed to run and the diagnostics screen would display an error code. See figure 10-1 and 10-2.

The operator would need to move the machine into the area of travel or reset the forward and reverse positions to eliminate this problem.

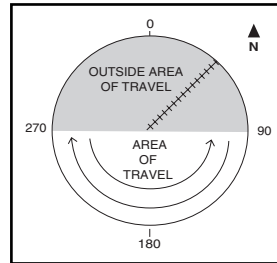

Figure 10-1

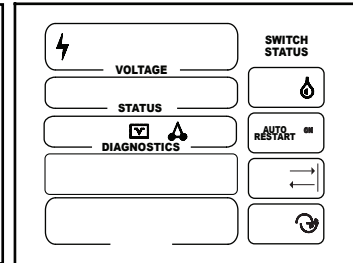

Figure 10-2

Forward Position

Forward position allows the operator to set the machine to change direction from reverse to forward when the auto reverse/auto stop constant is on. If the forward position feature is on, the machine will change direction from reverse to forward every time or stop depending if auto reverse or auto stop is selected. The value can be set from 0.0° to 359.9°.

NOTE

- If auto reverse/auto stop is disabled the forward and reverse position cannot be set and/or the setting will not execute.
- When forward or reverse position is displayed, holding the SELECT button for more than 2 seconds clears both the forward and reverse positions.

1. FOR POS should be flashing. See figure 10-3.
2. Press or to change the value. This position can be set to the nearest tenth of a degree.
3. Press to view the next value in the setup group.

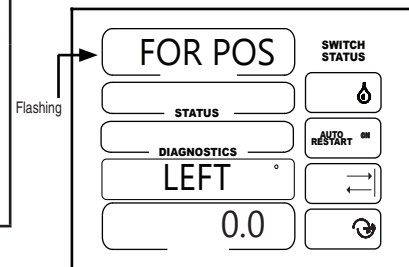

Figure 10-3

Reverse Position

Reverse position allows the operator to set the machine to change direction from forward to reverse when the auto reverse/auto stop constant is on. If the reverse position feature is on, the machine will change direction from forward to reverse every time or stop depending if auto reverse or auto stop is selected. The value can be set from 0.0° to 359.9°.

1. REV POS should be flashing. See figure 10-4
2. Press or to change the value. This position can be set to the nearest tenth of a degree.
3. Press to view the next value in the setup group.

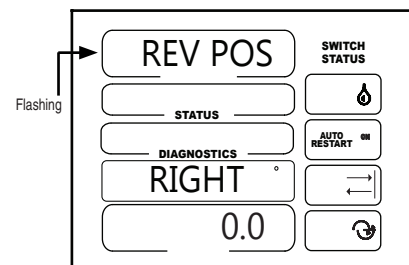

Figure 10-4

Setup Group 1 - Options

Variable Rate Irrigation Speed Control (VRI-S)

The variable rate irrigation speed option uses mapping software to divide the field in up to 180 sectors that relate to the sectors on a VRI-S prescription map. Each sector is associated with a percent timer setting to set a rate of application for that sector.

As the machine runs, the Select2 control panel uses a VRI-S prescription map along with the current resolver angle, GPS coordinates or run time to determine the percent timer setting for each sector.

Enabling and Disabling VRI-S

The VRI-S option can be enabled (on) or disabled (off) by doing the following:

1. VRI-S should be flashing. See figure 11-1.
2. Press **+** or **-** to enable VRI-S with desired prescription (on 1, on 2, on 3, on 4, on 5) or to disable the VRI-S option (off). See figure 25-1.
 - At least one VRI-S prescription must be downloaded to the control panel. If enabled without a prescription the machine will run at the percent timer setting.
 - Only one VRI-S prescription can run at one time.
3. Press **SELECT** to view the next value in the setup group

Position Values

VRI-S works with resolver, GPS or runtime positioning.

- If GPS is not activated, position values are provided by the resolver.
- If GPS is activated, position values are provided by the GPS receiver, but when there is not a GPS signal the position resorts to using backup, either runtime or resolver, runtime is recommended. An E18 error will be recorded.

Adjustments

Adjustments to the VRI-S prescription cannot be made at the control panel.

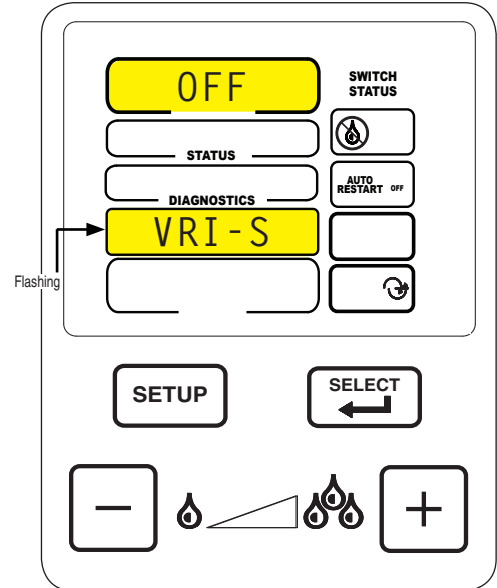

Figure 11-1

Valley Select2 Control Panel

Setup

Setup Group 1 - Options

Control Panel Display

Indication that variable rate irrigation speed (VRI-S) is enabled (on) or running is shown on the control panel in the voltage display.

- VRI is shown in the voltage display when water is set to on and a VRI-S prescription is enabled (on). See figure 12-1.
- The water application display cycles between ADJ %, ADJ Depth and set Depth when water is set to on and a VRI-S prescription is enabled (on). See figure 12-1.

NOTE

•While setting depth or percent timer the water application display does not cycle set depth with "adj. %" and "adj. depth".

- VRI is not shown in the voltage display:
 - » When water is set to off even when a VRI-S prescription is enabled (on). See figure 12-2.
- or
 - » When VRI-S prescription is disabled (off). See figure 12-2.

Irrigation Prescription

The prescription is created using a computer and the Variable Rate Irrigation Prescription software. See figure 12-3.

The VRI-Speed prescription has 180 sectors, each sector is 2 degrees wide. The percent values from the prescription are used to adjust the set application depth of the Select2 module.

Example: If the set application of the Select2 module is 1.00 in (25.4 mm) and the prescription map has a value of 70% in the sector where the pivot is currently running, then the Select2 module will adjust the speed of the pivot to achieve an application of 0.70 in (17.78 mm).

Downloading Prescription

Up to 5 prescriptions can be downloaded to the control panel.

The prescription can be downloaded to the Select2 control panel in several different ways:

- Prescription software program or prescription down loader with a serial cable connection to the optional control panel data port .
- BaseStation2-SM v7.3 or higher with radio connection to the control panel.
- TrackerSP GPRS with firmware version 10 or higher.
- TrackerSP CDMA with firmware version 14 or higher.

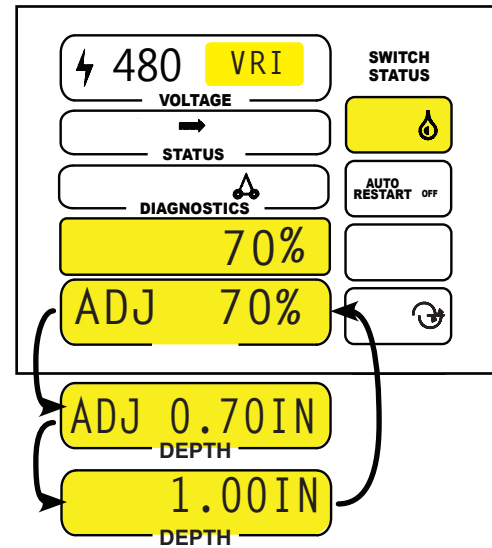

Figure 12-1

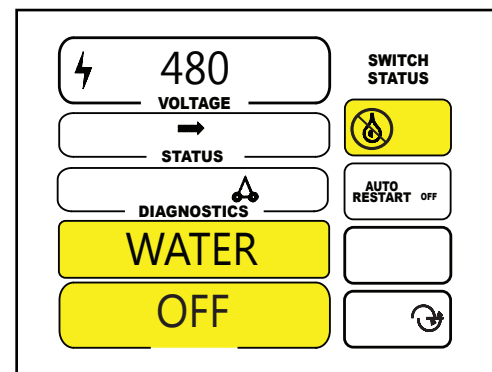

Figure 12-2

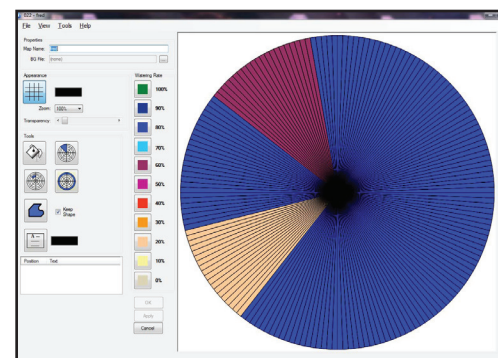

Figure 12-2 Example prescription as shown using VRI prescription software. The prescription in graphic form is not seen on the Select2 control panel.

Valley Select2 Control Panel

Setup

Setup Group 1 - Options

End Gun

A pivot can have up to nine end gun sequences, numbered 1 through 9. Each sequence consists of a left angle and a right angle. The wedge between the left and right angle is where the end gun will be turned on. See figure 13-1.

The end gun sequence number does not affect when the end gun turns on or off. The end gun turns on or off based on the left angle and right angle entries.

NOTE

• On the control panel display screen, the left angle is displayed as on and the right angle is displayed as off. However, this does not affect when the end gun turns on or off.

End gun sequences operate the same whether or not the machine is running in the forward or reverse direction:

- In the forward direction, the end gun turns on at the left angle and off at the right angle.
- In the reverse direction, the end gun turns on at the right angle and off at the left angle.

Angles can be entered in tenths of a degree to fine tune the end gun setting. For example, an angle can be input as 300.6°. However, 300.6° will be displayed as 300° on the status screen.

Typical Pivot End Gun Settings

Listed below are typical end gun settings for a pivot based on the field size and end gun being used. Notice that the pivot sectors are based on the location of 0° in relationship to the pivot. See figure 13-1 and the end gun settings table.

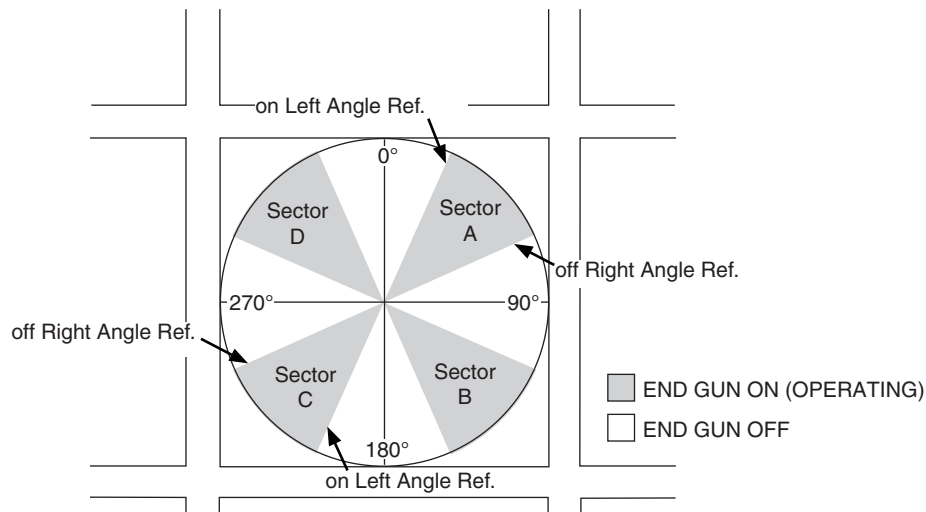

Figure 13-1

NOTE

• These settings are approximate and will vary for different fields.

End Gun Settings Table

NUMBER OF ACRES	END GUN	SECTOR A		SECTOR B		SECTOR C		SECTOR D	
		on (LEFT) ANGLE	off (RIGHT) ANGLE	on (LEFT) ANGLE	off (RIGHT) ANGLE	on (LEFT) ANGLE	off (RIGHT) ANGLE	on (LEFT) ANGLE	off (RIGHT) ANGLE
40	NELSon 100	31	59	121	149	211	239	301	329
40	RAINBIRD 85	27	63	117	153	207	243	297	333
160	NELSon 100	21	69	111	159	201	249	291	339
160	RAINBIRD 85	18	72	108	162	198	252	288	342
640	NELSon 100	16	74	106	164	196	254	286	344
640	RAINBIRD 85	13	77	103	167	193	257	283	347

Valley Select2 Control Panel

Setup

Setup Group 1 - Options

Setting End Gun

1. The screen illustrated in figure 14-1 signifies that end gun sector 1 is not programmed. If the voltage screen is empty, then no settings have been set for the indicated end gun sector.
2. Press **+** or **-** to turn on the end gun sector.
3. To set the on angle sector point, press **+** or **-** to increase or decrease the angle.
4. Press **SELECT**.

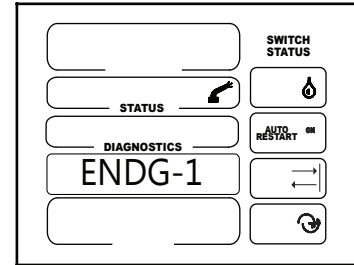

Figure 14-1

NOTE

- If the sector was never programmed and there are no lower numbered end guns programmed then the on angle will be 0.0°. See figure 14-2.
- If the sector was never programmed and a lower numbered end gun sector is programmed then the on angle will show the off angle of the next lowest programmed end gun sector.
- If the sector was not previously programmed and another sector did exist then the on angle will start with the previously programmed off angle.
- Press **SELECT** and hold for 2 seconds to clear the end gun settings.

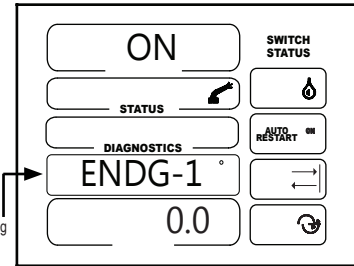

Figure 14-2

5. Press **+** or **-** to set the off angle of the end gun sector.
6. Press **SELECT**.
7. Continue pressing **SELECT** to change other end gun sector values or until the first wide boundary value is displayed.

NOTE

- If the sector was never programmed then the off angle should start with the same position as the on angle set in step 3. See figure 14-3.
- If the sector was never programmed and another sector previously existed then the off angle should start with the previously programmed off angle.

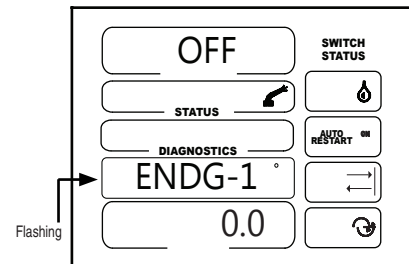

Figure 14-3

Setup Group 1 - Options

Wide Boundary

The wide boundary sequences can be used to control a corner machine sprinkler sequence, a second end gun, a span of sprinklers, or other electrically controlled devices.

Wide boundary sequences are numbered 1 through 9. Each sequence has a left angle and a right angle. The wedge between the left and right angle is where the wide boundary will be turned on. The wide boundary sequence number does not affect when the wide boundary turns on or off. The wide boundary turns on or off based on the left angle and right angle entries. See figure 15-1.

Wide boundary sequences operate the same whether or not the machine is running in the forward or reverse direction through a sequence.

- In forward, the wide boundary turns on at the left angle and off at the right angle.
- In reverse, the wide boundary turns on at the right angle and off at the left angle.

Angles can be entered in tenths to fine tune the wide boundary setting. However, an angle of 300.6° will be displayed as 300° on the screen.

1. The screen illustrated in figure 15-2 signifies that wide boundary sector 1 is not programmed. If the voltage area is empty then no settings have been set for the indicated wide boundary sector.
2. Press **+** or **-** to turn on the wide boundary sector.
3. To set the on angle sector point, press one of the applicator depth buttons to increase or decrease the angle.
4. Press **SELECT**.

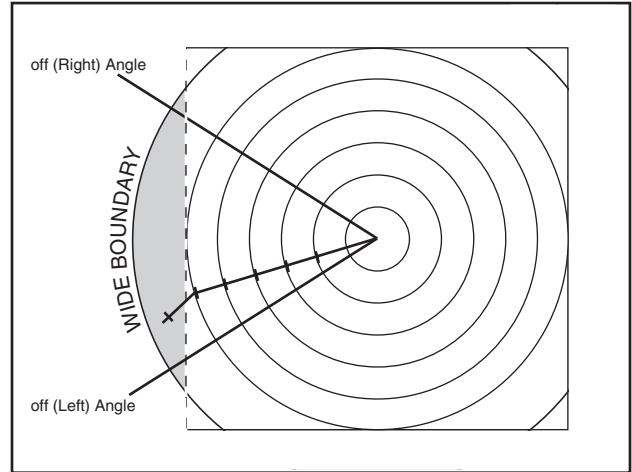

Figure 15-1

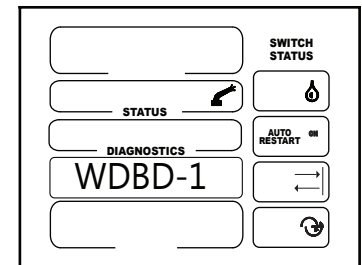

Figure 15-2

NOTE

- If the sector was never programmed and there are no lower numbered wide boundaries programmed then the on angle will be 0.0°. See figure 15-3.
- If the sector was never programmed and a lower numbered wide boundary sector is programmed then the on angle will show the off angle of the next lowest programmed wide boundary sector.
- If the sector was not previously programmed and another sector did exist then the on angle should start with the previously programmed off angle.
- Press and hold **SELECT** for 2 seconds to clear the wide boundary settings.

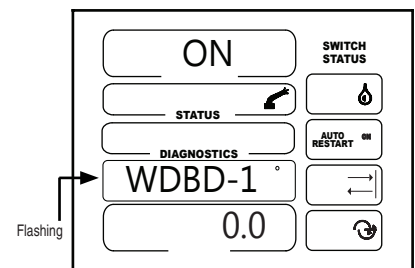

Figure 15-3

Valley Select2 Control Panel

Setup

Setup Group 1 - Options

Wide Boundary (continued)

5. Press or to set the off angle of the wide boundary sector.
6. Press .
7. Continue pressing to change other wide boundary sector values or until the setup group 2 is displayed.

NOTE

- If the sector was never programmed then the off angle should start with the same position as the on angle set in step 3. See figure 16-1.
- If the sector was never programmed and another sector previously existed then the off angle will start with the previously programmed off angle.

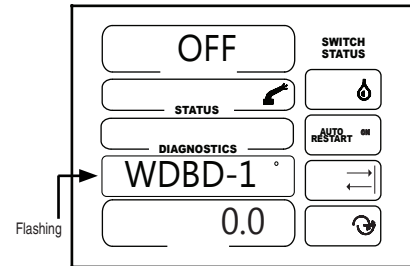

Figure 16-1

Valley Select2 Control Panel

Setup

Setup Group 2 - Programs

The following values can be set within setup group 2:

- Program On/Off • Sector Programs (1-9)
1. From the main screen, press and hold **SETUP** until GROUP 2 is displayed or press **SETUP** two times.
 2. GROUP 2 will be shown in the display screen. See figure 17-1.
 - Pressing **SELECT** advances the operator to the next value in the setup group. Any changes made will be saved.
 - Pressing **i** at any time within setup group will return the operator to the main screen. Any changes made will be saved.
 - Pressing **SETUP** at any time within the setup group will advance the operator to the next setup group. Any changes made will be saved.

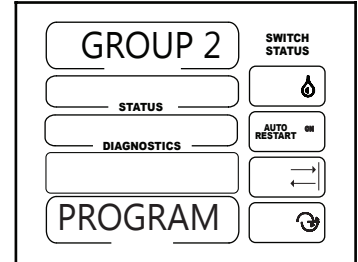

Figure 17-1

Sector Programs (1-9)

The Select2 software supports up to 9-user sector programs. A user sector program is an operator defined condition indicating the sector and direction that must be met in order to execute a set of commands. These commands include:

- Water On • Water Off • Depth • % Timer

Program On/Off

1. Program on/off allows the operator to turn on or turn off all of the programmed sectors. Figure 17-2 shows the off status.
2. Press **+** or **-** to change the value from off to on or on to off.
3. Press **SELECT** to view the next value.

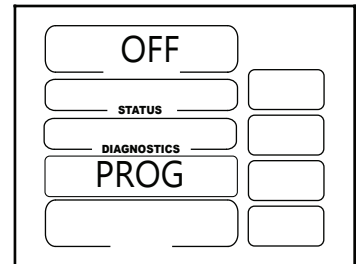

Figure 17-2

Left Angle

4. If no program exists, the depth and multiple information screens will be blank. See figure 17-3.
5. Press **+** or **-** to set the left angle of the sector.
or
Press **SELECT** to skip to the next programmed sector.
6. PROG 1 will change according to the programmed sector being added or modified. See figure 17-4.

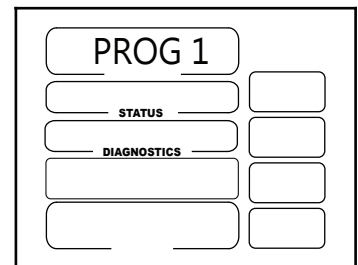

Figure 17-3

NOTE

- If the current sector program is not programmed and there are no other existing programs then the left angle will be 0.0 as displayed in figure 17-4.
- If there is no existing program and a lower numbered program exists then the left angle will show the right angle of the next lowest programmed sector.
- If a program exists then the display will show the left angle.

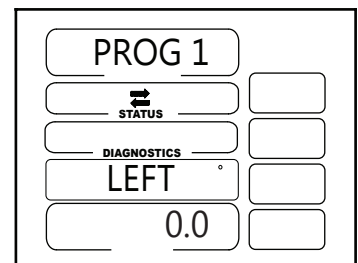

Figure 17-4

Valley Select2 Control Panel

Setup

Setup Group 2 - Programs

Sector Programs (1-9) (continued)

Direction



7. By default, a program will execute in both directions.

- a) Press  to turn on the forward icon and turn the reverse icon off. This indicates the program will execute in that direction only. See figure 18-1.

or

- b) Press  to turn on the reverse icon and turn the forward icon off. This indicates the program will execute in that direction only. See figure 18-2.



or

- c) Pressing  or  twice results in turning both icons on. This indicates the program will execute in both directions. See figure 18-3.



8. Press  to view the next value.

Water On/Off

The water on and depth of application or water off and percent timer value must be set for each sector. A new program has a default setting of water off with a percent timer value of 50%.

9. Press  to turn on the water and then press  or  to change the depth of water application setting inside of the sector. See figure 18-4.

or

Press  to turn off the water and then press  or  to change the percent timer setting inside of the sector.

10. Press  to view the next value.

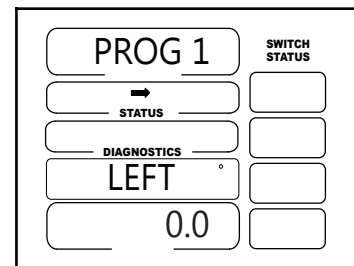

Figure 18-1

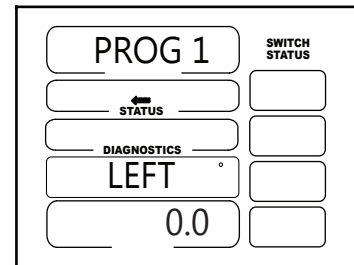

Figure 18-2

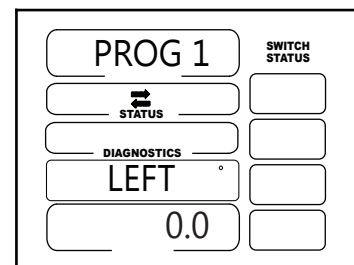

Figure 18-3

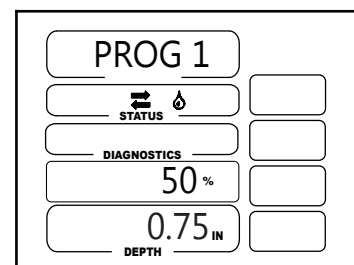

Figure 18-4

Setup Group 2 - Programs

Sector Programs (1-9) (continued)

Right Angle

11. Control panel display will look similar to figure 19-1. PROG 1 will change according to the programmed sector being added or modified.
12. Press or to set the right angle of the sector.
 - If this is a new program, the right angle may start with the same position as the left angle that was programmed in the previous step.
 - If the sector program exists, then the previous programmed position will be displayed.
13. Press . The next program will be displayed.
14. Press to change the values in the next program
or
Press to view the next setup group.

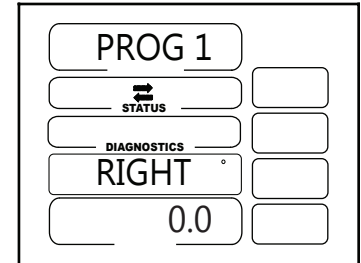

Figure 19-1

Overlapping Programs

Programs are allowed to overlap as long as the direction of travel is different. If there is an overlap of sectors an error will be displayed. See figure 19-2.

15. The operator must press to acknowledge the error. Return to the program that is overlapping to correct the error.

NOTE

- All programs will be turned off if the operator changes one of the commands inside a programmed sector that is being controlled by the sector program.
- The multiple information screen will blink "Prgoff". The operator must press the SELECT button to acknowledge and return to the display screen.

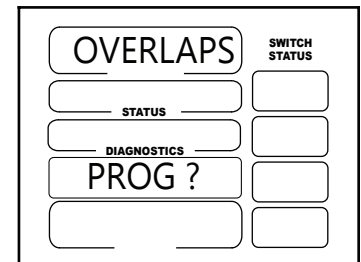

Figure 19-2

Valley Select2 Control Panel

Setup

Valley Select2 Control Panel

Setup

Setup Group 3 - Timers

The following Timer values can be set within setup group 3:

- Startup Pressure Delay
- Operating Pressure Delay
- Power Restart Delay
- Auto Reverse/Auto Stop Delay
- Percent Timer Cycle

1. From the main screen, press and hold **SETUP** until GROUP 3 is displayed or press **SETUP** three times.
2. GROUP 3 will be shown in the display screen. See figure 21-1.

- Pressing **SELECT** advances the operator to the next value in the setup group. Any changes made will be saved.
- Pressing **i** at any time within setup group will return the operator to the main screen. Any changes made will be saved.
- Pressing **SETUP** at any time within the setup group will advance the operator to the next setup group. Any changes made will be saved.

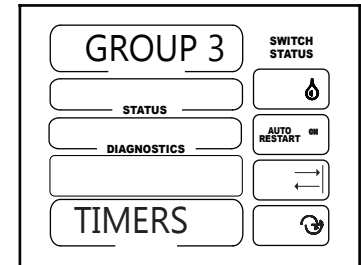

Figure 21-1

Startup Pressure Delay

The startup pressure delay bypasses the pressure transducer or pressure switch for the amount of time required in seconds for the machine to initially build water pressure above the low pressure limit after the pump has been started.

If the water pressure does not reach the low pressure limit before the startup pressure delay expires or water pressure drops below the low pressure limit (Setup Group 4 - Constants) at any time, error code E06 pump safety - pressure too low after pressure delay, is recorded (Setup Group 6 - Error Codes) and the operating pressure delay takes over.

The startup pressure delay has a range of 0 to 5000 seconds and the factory default is set to 600 seconds. Startup pressure delay can be displayed in PSI or KPa. See figure 21-2.

To change the startup pressure delay value complete the following steps:

1. SU-dly should be flashing.
2. Press **+** or **-** to change the value.
3. Press **SELECT** to view the next value in the setup group.

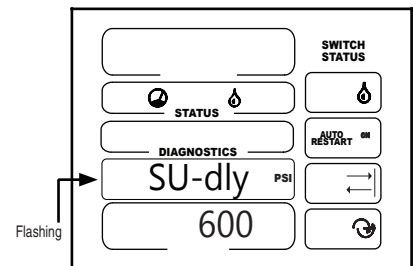

Figure 21-2

NOTE

- If a mechanical pressure switch is used, the start-up pressure delay value must be larger than the amount of time required for the pressure switch to close.

Valley Select2 Control Panel

Setup

Setup Group 3 - Timers

Operating Pressure Delay

The operating pressure delay is used to set the operating pressure delay value.

The operating pressure delay is active only after the start-up pressure delay has expired. The operating pressure delay is the amount of time in seconds that the machine will continue operating after pressure drops below the low pressure limit (Setup Group 4 - Constants).

Whenever the operation pressure drops below the low pressure limit, error code E06 pump safety - pressure too low after pressure delay, is recorded (Setup Group 6 - Error Codes). If the water pressure does not reach the low pressure limit before the operating pressure delay time expires, the machine is shut down due to a pressure fault, which is displayed on the diagnostics display.

The operating pressure delay has a range of 0 to 5000 seconds and the factory default is set to 30 seconds of continuous pressure loss. Operating pressure delay is reset when pressure rises above the low pressure limit. See figure 22-1.

To change the operating pressure delay value complete the following steps:

1. OP-dly should be flashing. See figure 36-1
2. Press **+** or **-** to change the value.
3. Press **SELECT** to view the next value in the setup group.

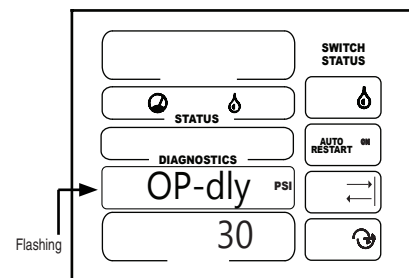

Figure 22-1

Power and/or Pressure Restart Delay

The power and/or pressure restart delay is used to set the power and/or pressure restart delay value.

If the machine stops due to a loss of power and/or water pressure and either are restored, the machine will restart automatically, after delaying for the specified time, if the power restart delay is turned on for pressure and power.

The time delay has a range of 0 to 5000 seconds and the factory default is set to 0 seconds. See figure 22-2.

To change the power and/or pressure restart delay value complete the following steps:

1. RS-dly should be flashing. See figure 36-2
2. Press **+** or **-** to change the value.
3. Press **SELECT** to view the next value in the setup group.

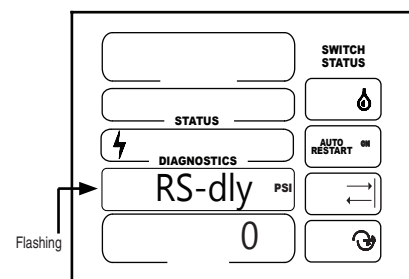

Figure 22-2

Valley Select2 Control Panel

Setup

Setup Group 3 - Timers

Auto Reverse/Auto Stop Delay

The auto reverse/auto stop delay is used to set the auto reverse/auto stop delay value.

The auto reverse/auto stop delay is used on a machine that is equipped with the drive unit mounted auto reverse/auto stop option. The delay will only occur when auto reverse/auto stop is on, water is on, and an auto reverse/auto stop event has occurred. The time delay has a range of 0 to 5000 seconds and the factory default is set to 0 seconds. See figure 23-1.

To change the auto reverse/auto stop delay value complete the following steps:

1. AR-dly should be flashing. See figure 37-1.
2. Press **+** or **-** to change the value.
3. Press **SELECT** to view the next value in the setup group.

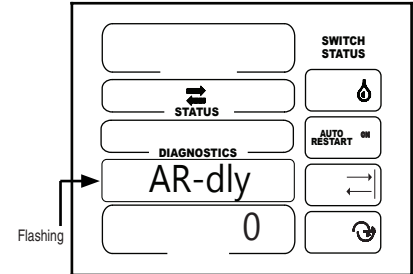

Figure 23-1

CAUTION

- WHEN A MACHINE MUST REVERSE DUE TO AN OBSTACLE, A DRIVE UNIT MOUNTED END OF FIELD STOP / AUTO REVERSE MUST BE INSTALLED WITH PHYSICAL BARRIERS AS A SAFETY BACK-UP.

Percent Timer Cycle

The percent timer cycle is used to set the percent timer cycle value.

When the percent timer cycle time is set at 60 seconds, and the percent timer is set at 50%, the end tower will move for 30 seconds of each minute and then stop for 30 seconds. The time delay has a range of 20 to 200 seconds and the factory default is set to 60 seconds. See figure 23-2.

To change the percent timer cycle value complete the following steps:

1. PerTmr should be flashing. See figure 37-2.
2. Press **+** or **-** to change the value.
3. Press **SELECT** to view the next value in the setup group.

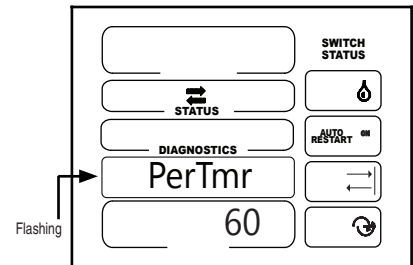

Figure 23-2

CAUTION

- INCREASING THE PERCENT TIMER CYCLE TIME SETTING OVER 60 SECONDS MAY CAUSE UNEVEN WATER DISTRIBUTION.

Valley Select2 Control Panel

Setup

Setup Group 4 - Constants

The following values can be set within setup group 4:

- Minimum Application
- Low Hours Per Revolution
- Low Pressure
- Voltage Calibration
- Low Voltage Setting
- Auto Reverse/Stop Enable
- Current Position
- Direction Offset
- Engine Control Pump/Engine/Alt Engine
- Auto Restart
- Flowmeter On/Off
- Flowmeter Gallons or Liters Pulse
- English or Metric Units
- Language

1. From the main screen, press and hold **SETUP** until GROUP 4 is displayed or press **SETUP** four times.
2. GROUP 4 will be shown in the display screen. See figure 25-1.
 - Pressing **SELECT** advances the operator to the next value in the setup group. Any changes made will be saved.
 - Pressing **i** at any time within setup group will return the operator to the main screen. Any changes made will be saved.
 - Pressing **SETUP** at any time within the setup group will advance the operator to the next setup group. Any changes made will be saved.

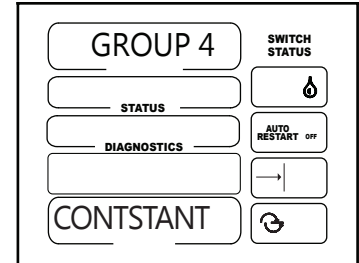

Figure 25-1

Minimum Application

The minimum application is the depth of water applied at a percentage timer setting of 100%. The value found on the VChart Report is specific to the machine and used to calculate water applications at different machine speeds. Range is 0.01 to 1.00 inches or 0 to 25.4 millimeters of water and default value is 0.25 inches. See figure 25-2.

1. LowAPP should be flashing. See figure 25-2.
2. Press **+** or **-** to change the value.
3. Press **SELECT** to view the next value in the setup group.

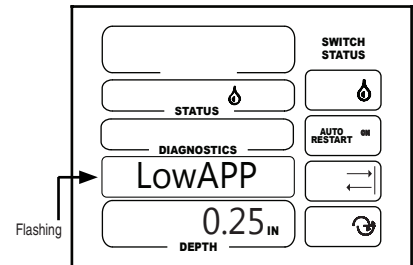

Figure 25-2

Low Hours Per Revolution

Low hours per revolution is the number of hours required for the machine to make one complete revolution at a percentage timer setting of 100% (maximum speed of the machine). This value found on the VChart Report is specific to the machine and used to calculate hours per revolution for different percentage timer settings. Range is 0.1 to 240.00 hours and default value is 24. See figure 25-3.

1. Low HR should be flashing. See figure 25-3.
2. Press **+** or **-** to change the value.
3. Press **SELECT** to view the next value in the setup group.

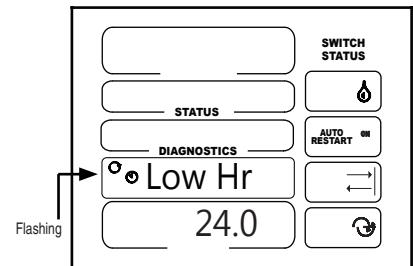

Figure 25-3

Low Pressure

Low pressure is used during start up and operation of the machine. Range is 0 to 100 and default value is 15. See figure 25-4.

- During startup, the machine will not move until the water pressure reaches the low pressure setting.
- During operation, if the water pressure drops below the low pressure setting and the operating pressure delay is allowed to expire, the machine is shut down.

1. LowPSI should be flashing. See figure 25-4.
2. Press **+** or **-** to change the value.
3. Press **SELECT** to view the next value in the setup group.

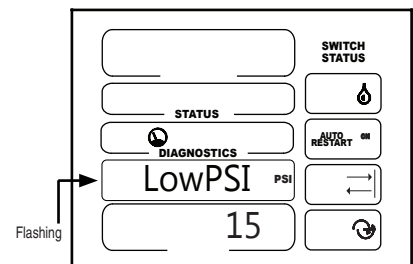

Figure 25-4

Valley Select2 Control Panel

Setup

Setup Group 4 - Constants

Voltage Calibration

The voltage constant calibrates the volt meter with the actual voltage coming into the control panel so that the voltage fluctuations can be monitored correctly.

The incoming voltage to the control panel must be measured with a meter by a qualified electrician or service person. This value is entered as the voltage constant.

1. CAL V should be flashing. See figure 26-1.
2. Press **+** or **-** to change the value to the actual measured voltage.
3. Press **SELECT** to view the next value in the setup group.

Supply voltage should never exceed the maximum supply voltage listed in figure 26-2.

Low Voltage

Low voltage is used to set the low voltage limit. The low voltage limit is factory set to 440 volts for use with a supply voltage of 480 VAC at 60 Hz. See figure 26-3.

If the control panel voltmeter senses voltage below the low voltage limit, a built-in timer keeps the machine running for up to 15 seconds to prevent nuisance shutdowns due to voltage fluctuations. If the low voltage condition still exists after 15 seconds, the machine will be shutdown and display screen will show a fault for machine power.

1. Low V should be flashing. See figure 26-3.
2. Press **+** or **-** to change the value to the desired low voltage shutdown setting.
3. Press **SELECT** to view the next value in the setup group.

Recommended low voltage limits for other supply voltages are shown in figure 26-4:

⚠ CAUTION

- **DO NOT SET LOW VOLTAGE LOWER THAN THE RECOMMENDED LOW VOLTAGE LIMIT.**
- **LOW VOLTAGE WILL DAMAGE THE DRIVE MOTORS AND OTHER ELECTRICAL COMPONENTS.**
- **CORRECT THE PROBLEM BEFORE RESUMING OPERATION.**

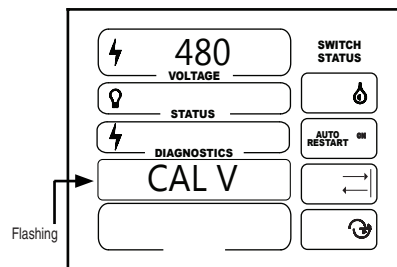

Figure 26-1

Nominal Supply Voltage	Maximum Supply Voltage
480 VAC @ 60Hz	505 VAC
415 VAC @ 50Hz	420 VAC
400 VAC @ 50Hz	420 VAC
380 VAC @ 50Hz	420 VAC
230 VAC @ 60Hz	253 VAC
220 VAC @ 50Hz	243 VAC
120 VAC @ 60Hz	132 VAC
110 VAC @ 50Hz	121 VAC

Figure 26-2

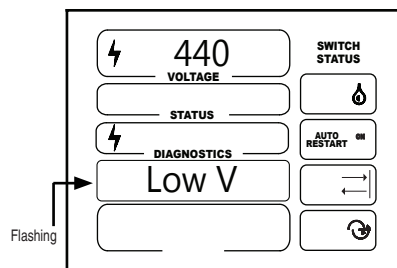

Figure 26-3

Nominal Supply Voltage	Recommended Low Voltage Setting
480 VAC @ 60Hz	440 VAC
415 VAC @ 50Hz	375 VAC
400 VAC @ 50Hz	365 VAC
380 VAC @ 50Hz	355 VAC
230 VAC @ 60Hz	220 VAC
220 VAC @ 50Hz	210 VAC
120 VAC @ 60Hz	105 VAC
110 VAC @ 50Hz	95 VAC

Figure 26-4

Setup Group 4 - Constants

Auto Reverse/Auto Stop (AR/AS) Options



Listed below are two different options for auto reversing or auto stopping the machine based on the presence of physical obstacles in the field and the presence of a physical barricade.

Option I - Drive Unit Mounted AR/AS

If the pivot needs to reverse around or stop at a physical obstacle such as part circle end of field, a tree line, building, grain bin, etc., the drive unit mounted AR/AS option with physical barricades must be used. See figure 27-1.

Using Drive Unit Mounted AR/AS

To use the drive unit mounted AR/AS the following conditions must exist:

- Auto reverse/auto stop must be enabled (Setup Group 4).
- The forward position and reverse position (Setup Group 1) must be set to the same value to disable their function.
- The drive unit mounted AR/AS must be installed.
- Physical barricades must be installed in the field to both contact the actuator arm of the drive unit mounted AR/AS and prevent collision of the machine with any physical obstacle.
- At the control panel, press either the auto reverse  or auto stop  button to select the mode of operation.

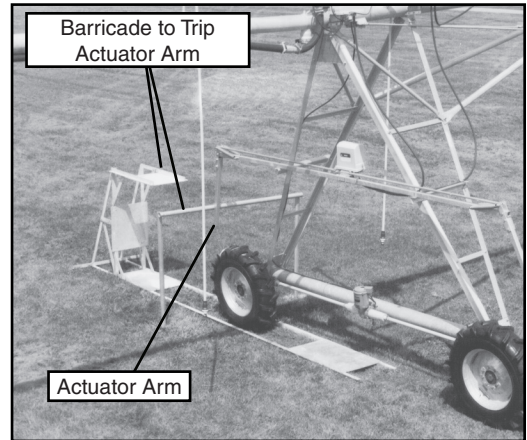

Figure 27-1

NOTE

- If only the drive unit mounted auto stop option is installed, the machine will stop when the actuator arm is tripped regardless if the auto stop switch is pressed or not. To restart, the operator must start the machine in the opposite direction.

CAUTION

- THE OPERATOR SHOULD NEVER BE REQUIRED TO ROUTINELY PRESS THE OVERRIDE BUTTON WHEN USING DRIVE UNIT AUTO REVERSE OR AUTO STOP. IF THIS SITUATION EXISTS CONTACT YOUR VALLEY DEALER
- SOIL MAY BUILD UP IN THE WHEEL TRACK RESULTING IN A RAMP EFFECT ALLOWING THE ACTUATOR ARM TO GO OVER THE BARRICADE. THE OPERATOR MUST KEEP THE WHEEL TRACK TO EACH BARRICADE FREE OF SOIL BUILD UP AND ENSURE THAT THE ACTUATOR ARM WILL CONTACT THE BARRICADE.

Option II - Operator Programmed AR/AS



If the pivot needs to reverse or stop in a typical full circle open field situation where there are not any physical obstacles such as part circle end of field, a tree line, building, grain bin, etc. the operator programmed AR/AS can be used. See figure 27-2.

WARNING

- DO NOT USE OPERATOR PROGRAMMED AUTO REVERSE/AUTO STOP IF PHYSICAL OBSTACLES ARE PRESENT IN THE FIELD WITHOUT A PHYSICAL BARRICADE.

Using Operator Programmed AR/AS

To use the operator programmed auto reverse/auto stop the following conditions must exist:

- Auto reverse/auto stop must be enabled (Setup Group 4).
- The forward position and reverse position (Setup Group 1) must be set to different values to enable their function.
- A resolver or GPS positioning option must be used to sense the position of machine.
- At the control panel, press either the auto reverse  or auto stop  button to select the mode of operation.

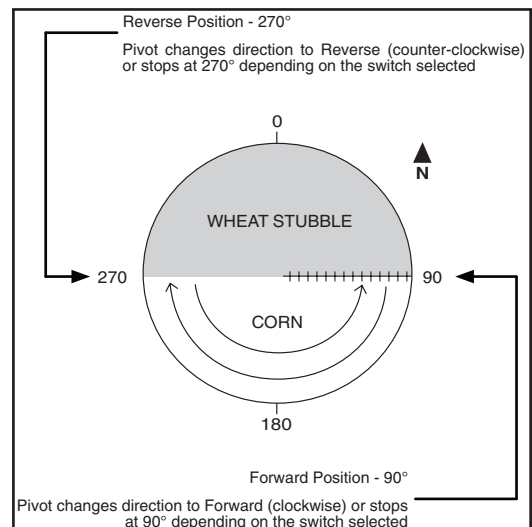

Figure 27-2



Valley Select2 Control Panel

Setup

Setup Group 4 - Constants

Auto Reverse/Auto Stop (AR/AS)

The auto reverse/auto stop constant enables (on) or disables (off) the auto reverse/auto stop buttons and function. AR/AS must be set to on (enabled) for either of the AR/AS options to be active. The factory default is off. See figure 28-1.

1. AR-AS should be flashing. See figure 28-1.
2. Press  or  to turn the auto reverse/stop on or off.
3. Press  to view the next value in the setup group.



Current Position

The current position setting constant is used for setting the current position of the machine when a resolver or GPS positioning option is used to sense the position of machine.

When setting current position for a GPS system, the pivot point position (Setup Group 8) must be set before the current position is set.

If there is no GPS signal, POSITION will not flash, NO GPS will be displayed and any changes made to the value will not be saved. See figure 28-2.

Setting Current Position

1. POSITION should be flashing and both the unfiltered position and current position values are displayed. See figure 28-3.
2. Press  or  to change the value.
3. Press  to view the next value in the setup group.

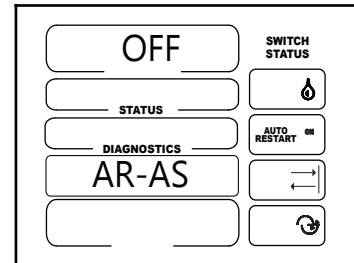

Figure 28-1

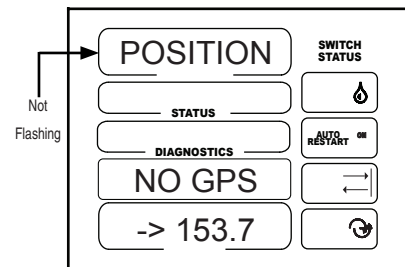

Figure 28-2

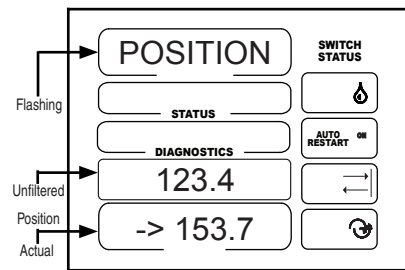

Figure 28-3

NOTE

- If position accuracy is in question, the operator should not change the value of the current position until after reviewing the position accuracy section.

Setup Group 4 - Constants

Resolver Direction Offset

The direction offset value is used to adjust the position readings from the resolver so that the end gun, sector control, stop-in-slot settings, and programmed values will repeat at the same position each time around the field in different directions. A complete explanation of the direction offset is given next in the resolver position accuracy section.

The operator should not change the value of the direction offset until after reviewing the position accuracy section. Instructions, to be given after the position accuracy section, will explain how to adjust the direct offset setting. The direction offset has a range of 0.1 to 10.00° and the factory default is set to 0.5°.

NOTE

- Move the machine in the same direction for 20° before making any angular adjustments.
- Make sure the direction selected is the same before reentering the angle or the direction offset could be off by double the amount.
- The operator should not change the value of the current position until after reviewing the position accuracy section.

Resolver Position Accuracy

The Select2 control panel may utilize a resolver which is installed in the collector ring to determine the position of the pivot in the field as illustrated in figure 29-1.

As the pivot rotates, the collector ring turns which also turns the shaft of the resolver and sends back two voltage signals to the Select2 control panel. These voltage readings change as the resolver shaft turns.

The Select2 panel then uses these voltage readings to determine the field position in degrees.

These field position readings are then used to turn the end gun on and off or to stop at the stop-in-slot position.

Some machines may require adjustments to the pivot position readings.

These adjustments may be required for a number of reasons including if the packing material around the J-pipe is too tight. These situations will be different for every machine, so therefore, you have the ability to make an adjustment based on your individual machine.

Machines which always run in one direction, will generally not need adjustments. It is when the machine reverses its direction that “slight adjustments” may need to be made to the direction offset.

In this case, the end gun may turn on/off at a location several degrees different than when the machine was running the other direction.

The same inaccuracy could hold true for the stop-in-slot setting. The reason for this is that any “slack” in the mechanical connection to the resolver is taken up during the direction change and can result in position inaccuracies in the opposite direction.

It is important to note that accuracy can be expected within a range of $\pm 1.0^\circ$. One degree on a standard length machine of 1320 feet is equal to 23 feet at the last regular drive unit.

The direction offset constant is utilized to adjust or “offset” any inaccuracies in the readings on the screen. If the end gun on/off locations or the stop-in-slot locations are not repeatable when the direction of the machine is changed, then follow the procedures in the next section to determine the appropriate direction offset constant.

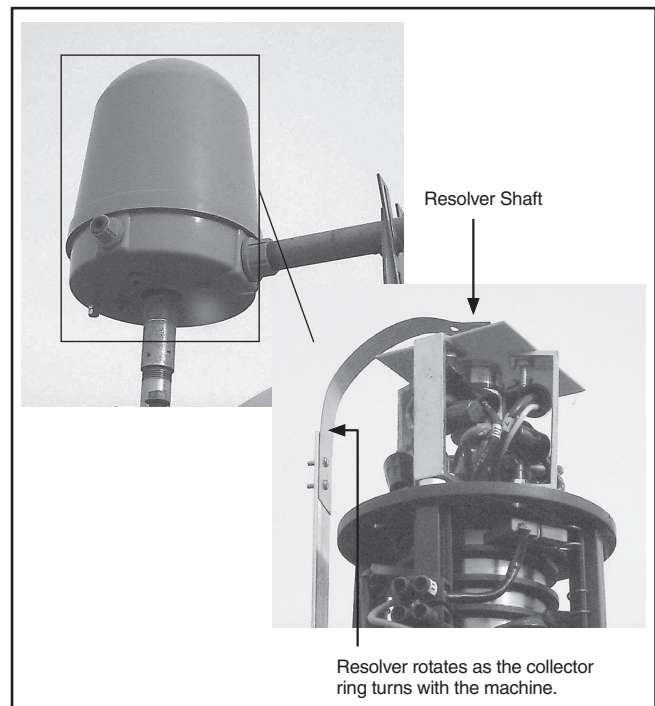

Figure 29-1

Valley Select2 Control Panel

Setup

Setup Group 4 - Constants

Resolver Direction Offset

Estimated Direction Offset

The factory preset value for direction offset is 0.5° . This value is estimated and generally is sufficient in most cases.

However, you may notice that when the direction of the pivot is changed that the end gun turns on or off past or before the normal settings.

- If the machine runs past the normal end gun on/off settings, the direction offset needs to be increased.
- The direction offset must be decreased if the machine is short of the normal end gun on/off settings.

This same logic would also hold true for a stop-in-slot setting as described in the following example:

EXAMPLE

The stop-in-slot has been set at the pivot road which has been defined as 90.0° . When the machine is running in the forward direction, it always stops near the pivot road.

However, when the direction of the machine is changed to reverse, the machine runs past the road about 25 feet as illustrated in figure 30-1.

On a standard length machine of 1320 feet (typical quarter section machine), one degree on the outer end of the machine is approximately 23 feet. Therefore, the machine “over ran” by about 1° degree.

In this case you would add one half of this estimated value to the existing direction offset value. If the existing value was 1.0° (factory preset value), then the new value would be approximately $1.0^\circ + 0.5^\circ = 1.5^\circ$.

In the same example, if the pivot would have stopped short by about one degree, then the existing direction offset value would have been decreased by approximately half a degree.

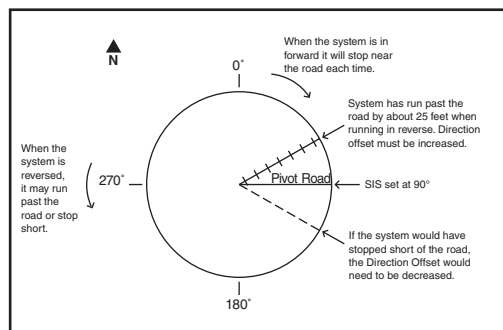

Figure 30-1

NOTE

- The estimated degrees should be divided by two and added or subtracted to the existing direction offset value.
- If the pivot is “over running” the locations of end gun operation or stop-in-slot, then **INCREASE** the direction offset. If the pivot is coming up short of these locations, then **DECREASE** the direction offset value.

Setup Group 4 - Constants

Resolver Direction Offset

Calculating The Direction Offset

To calculate the direction offset value, follow these steps:

1. Start the machine in the forward or reverse direction and watch the position reading on the display screen. For this example the running direction used is reverse. When you see the position change by 7° , stop the machine. This indicates that all of the mechanical slack has been taken out of the resolver. In other words, the resolver is turning as the pivot rotates.
2. Place a flag next to wheel track and in line with center of rear wheel on the first regular drive unit. This is position A. See figure 31-1.

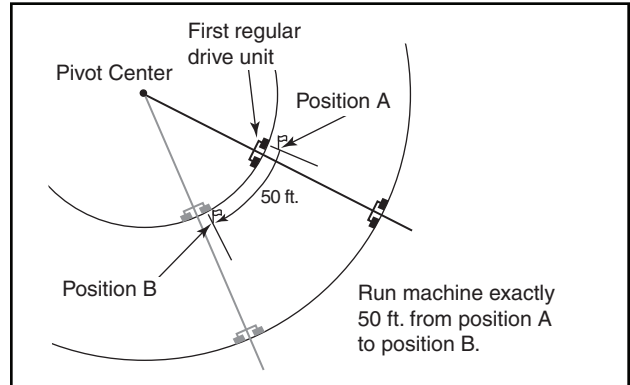

Figure 31-1

In the running direction opposite to that in step 1, measure a distance of 50 feet from position A, along the first regular drive unit wheel track and place another flag. This is position B. For this example the opposite running direction is forward. See figure 31-1.

3. From the main screen, press the **i** button six times to view the current position. Record the current position displayed at the bottom of the screen to the nearest tenth of a degree as position A. See figure 31-2.

Position A = _____ Degrees

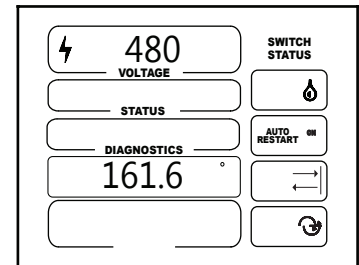

Figure 31-2

4. Start the machine in the running direction opposite of that in step 1 and let it run exactly 50 feet, the flag at position B should be in line with center of rear wheel on the first regular drive unit. Then stop the machine.
5. Access the current pivot position again and record the current position displayed at the bottom of the screen to the nearest tenth of a degree as position B. See figure 31-3.

Position B = _____ Degrees

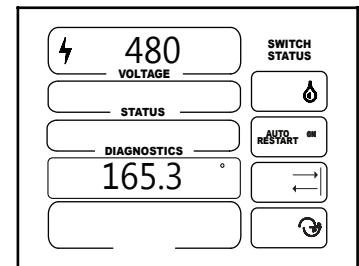

Figure 31-3

6. Measure the distance in feet from the center of the pivot to the centerline of the tire on the first regular drive unit. This distance is R. See figure 31-4.

R = _____ Feet

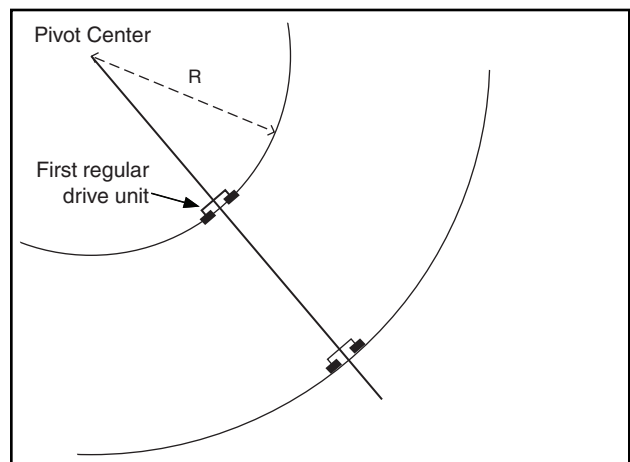

Figure 31-4

Valley Select2 Control Panel

Setup

Setup Group 4 - Constants

Resolver Direction Offset

Calculating The Direction Offset (continued)

7. Use the measured degrees formula to determine how many degrees the pivot should travel in 50 feet. This is the measured degrees.

NOTE

• Calculate the "measured degrees" to the nearest tenth. Remember, the formula above is only good for 50 feet of travel at the first regular drive unit. If you only measure 40 feet worth of travel, this formula can't be used.

8. Use the actual degrees formula to determine the actual degrees traveled. This is the difference in readings between position A and position B.

NOTE

• If this value is negative, drop the negative sign and use as a positive value.

9. Press **SETUP** four times to access the setup group 4.
10. Press **SELECT** eight times to access the direction offset screen. See figure 32-1.
11. Record the current direction offset displayed at the bottom of the screen. See figure 32-1 .
Current Direction Offset = _____
12. Calculate the value for the new direction offset using one of the two formulas shown below. Then set the new direction offset.

Measured Degrees Formula

$$\begin{aligned} \text{Measured Degrees} &= (2864.8) / (R) \\ &= (2864.8) / (______) \\ &= ______ \end{aligned}$$

Actual Degrees Formula

$$\begin{aligned} \text{Actual Degrees} &= \text{Position B} - \text{Position A} \\ &= (______) - (______) \\ &= ______ \end{aligned}$$

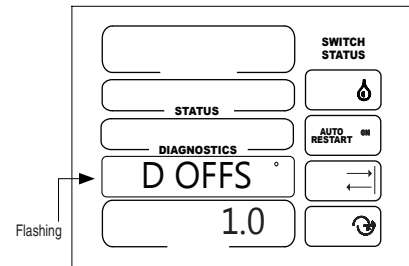

Figure 32-1

Actual Degrees Less Than Measured Degrees

$$\text{Dir Offset} = \text{Current Dir. Offset} + \left[\frac{(\text{Measured Degrees}) - (\text{Actual Degrees})}{2} \right]$$

$$\text{Dir Offset} = 1.0 + \left[\frac{(______) - (______)}{2} \right]$$

$$\text{Dir Offset} = 1.0 + \left[\frac{(______)}{2} \right]$$

$$\text{Dir Offset} = 1.0 + ______$$

$$\text{Dir Offset} = ______$$

Actual Degrees Greater Than Measured Degrees

$$\text{Dir Offset} = \text{Current Dir. Offset} - \left[\frac{(\text{Actual Degrees}) - (\text{Measured Degrees})}{2} \right]$$

$$\text{Dir Offset} = 1.0 - \left[\frac{(______) - (______)}{2} \right]$$

$$\text{Dir Offset} = 1.0 - \left[\frac{(______)}{2} \right]$$

$$\text{Dir Offset} = 1.0 - ______$$

$$\text{Dir Offset} = ______$$

Setup Group 4 - Constants

Resolver Direction Offset

Entering The Direction Offset

To enter a value for the direction offset, follow these steps:

1. Press **SETUP** four times to access setup group 4.
2. Press **SELECT** eight times to access the direction offset screen. See figure 33-1.

NOTE

•Notice the value displayed is 0.5. This is the default value from the factory. To change the value, enter the calculated offset. A value for D OFFS of less than 0.5 will not be accepted.

3. Press **+** or **-** to advance the display.
4. Press **SELECT** to view the next value in the setup group.
5. Press **i** to return to the main screen.

NOTE

•The position adjustment procedure has now been completed. End gun settings, SIS positions, and position related programs may need to be fine-tuned. Adjust these settings as required after one revolution of the pivot is completed

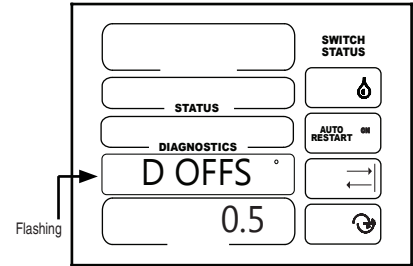

Figure 33-1

Engine Control Pump/Engine/Alt Engine

The engine control pump/engine/alt engine is used to select and control the type of pumping unit that is being used with the machine. The factory default setting for engine control pump/engine/alt engine is pump as illustrated in figure 33-2.

1. Eg/Pmp should be flashing. See figure 33-2.
2. Press **+** or **-** to change the value.
3. Press **SELECT** to view the next value in the setup group.

PUMP designates an electric motor is being used to operate the pumping unit. The pump mode will engage the pump safety relay when water is turned on and disengage the relay when water is turned off.

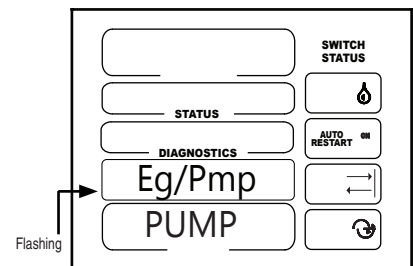

Figure 33-2

RECOMMENDED:

Alt engine will stop the machine after a 1.5 second delay. This allows 1.5 seconds for the Select2 module to save the updated safety fault status, then disengage the engine.

NOT RECOMMENDED:

Engine indicates an internal combustion engine is being used as the power for operating the pump. The engine mode will keep the pump safety relay engaged while the machine is running, water on or water off, and disengage the relay when the machine is stopped. The shutdown sequence will stop the machine and disengage the engine simultaneously after a 3.0 second delay. However, this incorrectly logs a safety shutdown as a power fault and therefore is not recommended.

The Alt Engine shutdown sequence is required for saving the safety or power fault event correctly.

Valley Select2 Control Panel

Setup

Setup Group 4 - Constants

Auto Restart Both/Pressure/Power

Use the auto restart both/pressure/power option to restart a machine automatically if it was last shut down because of a loss of power and/or pressure.

1. AutoRS should be flashing. See figures 34-1, 34-2 and 34-3.
2. Press or to change the value.
3. Press to view the next value in the setup group.

NOTE

- The machine will only restart if it was last shut down because of a loss of power or loss of pressure.
- If the machine is shut down by pressing the STOP button or by an end of field shut down, it would not restart if there were a loss of power or pressure because the initial shut down was not caused by loss of power or pressure.
- When the operator starts the machine and the AUTO RESTART ON switch is pressed, auto restart is active again.

Auto Restart Both

When auto restart both is selected and the machine shuts down due to a loss of pressure or a loss of power. See figure 34-1.

The machine will restart when pressure is regained and reaches the low pressure limit or if power is regained.

Auto Restart Pressure

When auto restart pressure is on and a shut down occurs because of a loss of pressure, the machine will restart when pressure is regained and reaches the low pressure limit or if power is cycled as long as low pressure shut the system down. See figure 34-2.

If a machine restarts due to a loss of pressure, it will start with the same running conditions as when it previously lost pressure, just as if START was pressed.

The machine will restart after a loss of power if only this option is selected and if pressure initially shut it down, but will not restart if power shuts it down.

Auto Restart Power

When auto restart power is on and a shut down occurs because of a loss of power, the machine will restart when power is restored and will use the same running conditions as when it lost power. See figure 34-3.

The machine will not restart after a loss of pressure if only the auto restart power option is selected.

NOTE

- Regardless of whether the water pressure is above or below the low pressure setting when the power is restored, the machine will wait for the amount of time specified in the power restart delay (Setup Group 3) before restarting.

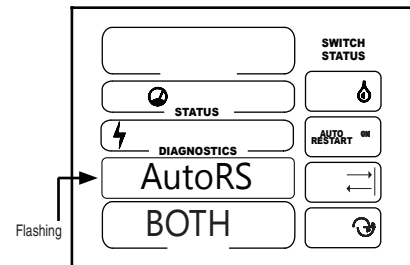

Figure 34-1

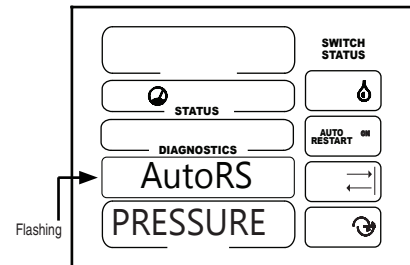

Figure 34-2

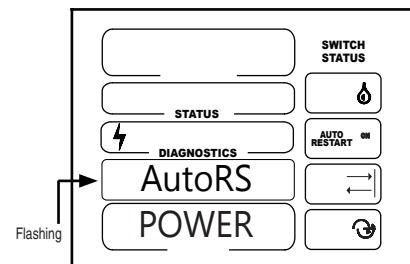

Figure 34-3

Setup Group 4 - Constants

Flowmeter

The flowmeter on/off constant enables (on) or disables (off) the flowmeter function. Flowmeter must be set to on (enabled) for the flowmeter option to be active. The factory default is off. See figure 47-1.

1. FlwMtr should be flashing. See figures 35-1.
2. Press **+** to turn flowmeter on or **-** to turn flow meter off.
3. Press **SELECT** to view the next value in the setup group.

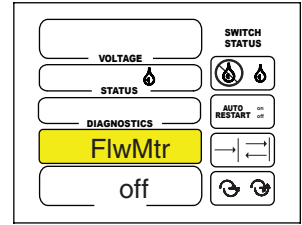

Figure 35-1

Flowmeter Gallons or Liters per Pulse

The flowmeter gal/Pulse (or ltr/Pulse) constant is used to adjust the gallons or liters per pulse setting. The range is 000.001 to 100.000 gal/P. The default is off. See figure 47-2.

1. gal/P (or ltr/P) should be flashing. See figures 35-2.
2. Press **+** or **-** to change the value.
3. Press **SELECT** to view the next value in the setup group.

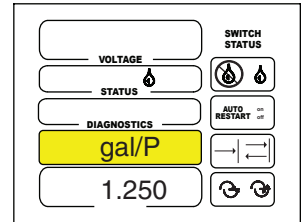

Figure 35-2

NOTE

- When set to English units "gal/P" is displayed.
- When set to metric units "ltr/P" is displayed.

When flow meter is on, the following additional information will be displayed on the multiple information display: Flow, Total Flow (Mil. Gal.), and Pulse Count.

Press **i** to cycle through the multiple information displays:

- Press **i** 7 times to display Flow. See figure 49-3.
- Press **i** 8 times to display Total Flow. See figure 49-4.
- Press **i** 9 times to display Flow Counter 0. See figure 49-5.

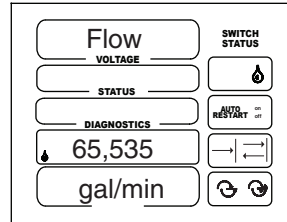
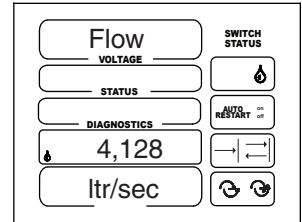

Figure 35-3 English=gal/min



Metric=ltr/sec

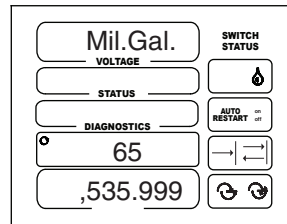
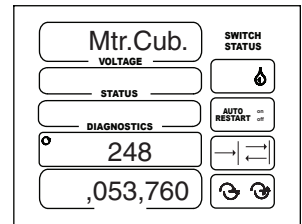

Figure 35-4 English=gal/min



Metric=ltr/sec

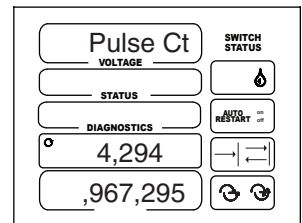

Figure 35-5 English=gal/min

Valley Select2 Control Panel

Setup

Setup Group 4 - Constants

English or Metric Units

Measurements can be displayed in either English units or metric units. The default is English units.

Depending on the units of measure selected:

- The water pressure reading will be displayed in either English units, pounds per square inch (psi) or Metric Units, kilo pascals (KPa). See figures 36-1 and 50-2.
- The water application depth will be displayed in either English units, inches (IN) or metric units, millimeters (mm). See figures 50-1 and 36-2.

To change to the displayed units of measure do the following:

1. UNITS should be flashing. See figures 36-1 and 36-2.
2. Press **+** or **-** to change the value.
3. Press **SELECT** to view the next value in the setup group.

Language

The Select2 panel has the capability to display screens in the following languages: ENGLISH, ESPANOL, FRANCAIS, ITALIANO, or PORTUGUE. See figure 36-3.

1. LANGUAGE should be flashing. See figure 36-3.
2. Press **+** or **-** to change the value.
3. Press **SELECT** to view the next value in the setup group.

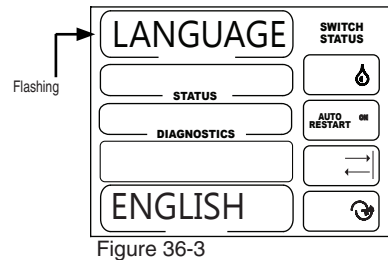
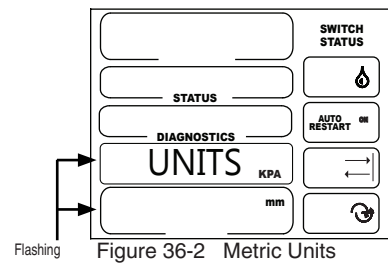
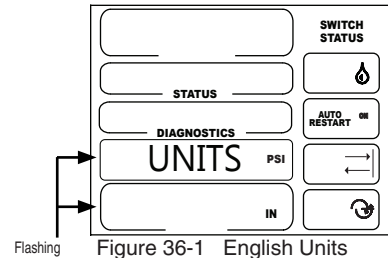

Valley Select2 Control Panel

Setup

Setup Group 5 - Communications

The following values can be set within setup group 5:

- Baud 9-Pin • Protocol 9-Pin • Baud 25-Pin • Protocol 25-Pin • RTU ID

1. From the main screen, press and hold **SETUP** until GROUP 5 is displayed or press **SETUP** five times.
2. GROUP 5 will be shown in the display screen. See figure 37-1.
 - Pressing **SELECT** advances the operator to the next value in the setup group. Any changes made will be saved.
 - Pressing **i** at any time within setup group will return the operator to the main screen. Any changes made will be saved.
 - Pressing **SETUP** at any time within the setup group will advance the operator to the next setup group. Any changes made will be saved.

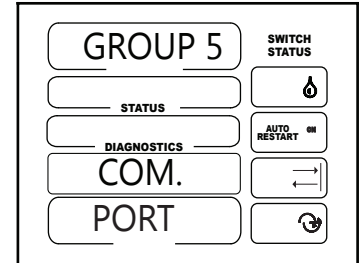

Figure 37-1

Communications port is used to set the control panel communications port, protocol, and baud rate for information that is transmitted and received when communicating with another computer. The baud rate must be set to match the equipment connected to the Select2 control module.

- The 9-Pin com port is typically used as the telemetry connection for remote communications with BaseStation, BaseStation2, Tracker SP, Tracker, etc. The factory default setting is remote control protocol at 9600 baud.
- The 25-Pin com port is used for direct connections to an option or by Valley dealers for service related functions. The factory default setting is service tool protocol at 57600 baud.
- Protocols are remote control, GPS or service tool.

Baud 9-Pin

Settings include 300, 1200, 2400, 4800, 9600, 19200, 38400, 57600, and 115200 baud. The default is 9600 baud. See figure 37-2.

1. BAUD 9-PIN should be flashing. See figure 37-2.
2. Press **+** or **-** to change the value.
3. Press **SELECT** to view the next value in the setup group.

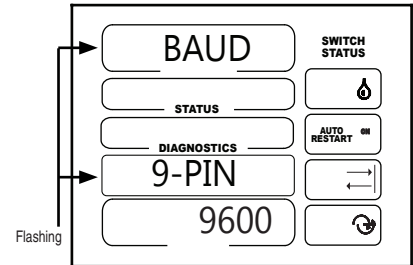

Figure 37-2

Protocol 9-Pin

Settings include REM CTL (remote control), GPS V1, GPS V2, REMCTLV2, and SRVCTOOL (service tool). The default is REM CTL. See figure 37-3.

1. PROTOCOL 9-PIN should be flashing. See figure 37-3.
2. Press **+** or **-** to change the value.
3. Press **SELECT** to view the next value in the setup group.

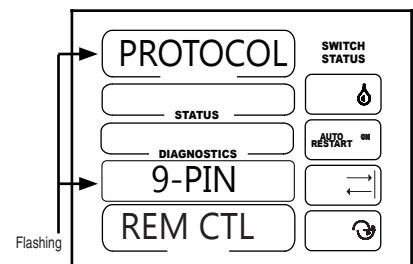

Figure 37-3

NOTE

- A protocol can be used by either com port, but it cannot be used by both com ports at the same time.
- GPS V1 and GPS V2 cannot both be selected.

Valley Select2 Control Panel

Setup

Setup Group 5 - Communications

Baud 25-Pin

Settings include 300, 1200, 2400, 4800, 9600, 19200, 38400, 57600, and 115200 baud. The default is 57600 baud. See figure 38-1.

1. BAUD 25-PIN should be flashing. See figure 38-1.
2. Press **+** or **-** to change the value.
3. Press **SELECT** to view the next value in the setup group.

Protocol 25-Pin

Settings include REM CTL (remote control), GPS V1, GPS V2, REMCTLV2, and SRVCTOOL (service tool). The default is REM CTL. See figure 38-2.

1. PROTOCOL 25-PIN should be flashing. See figure 38-2.
2. Press **+** or **-** to change the value.
3. Press **SELECT** to view the next value in the setup group.

NOTE

- A protocol can be used by either com port, but it cannot be used by both com ports at the same time.
- GPS V1 and GPS V2 cannot both be selected.

RTU ID

The RTU ID (Remote Telemetry Unit Identity) is set only when an optional remote telemetry device will be used to communicate with the control panel. The control panel RTU ID is a unique number between 000 and 997 that the user selects. None of the user's other control panels or BaseStations can have the same RTU ID number.

- The RTU ID number 0 is the factory setting for all RTU devices. See figure 38-3.
 - Do not use RTU ID number 998 or 999, these numbers are typically reserved for use by a primary BaseStation.
1. RTU-ID should be flashing. See figure 38-3.
 2. Press **+** or **-** to change the value.
 3. Press **SELECT** to view the next value in the setup group.

NOTE

- The panel's RTU ID 000 to a communication device is displayed as 0. If the RTU ID is 017 at the BaseStation, then the display must be set to 17 at the panel.

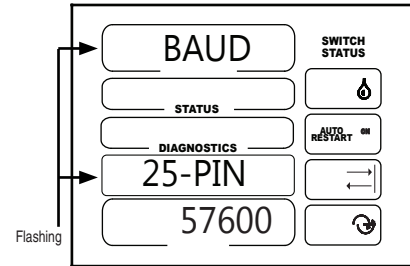

Figure 38-1

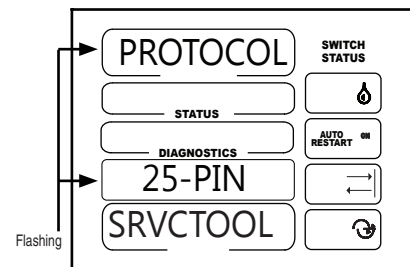

Figure 38-2

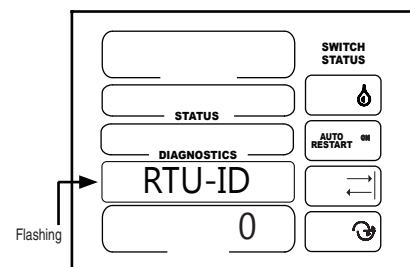

Figure 38-3

Setup Group 6 - Error Codes

The following values can be viewed and reset within setup group 6:

- Error codes E01-E14, E18-E20, E23, and E25.
1. From the main screen, press and hold **SETUP** until GROUP 6 is displayed or press **SETUP** six times.
 2. GROUP 6 will be shown in the display screen. See figure 39-1.
 - Pressing **SELECT** advances the operator to the next value in the setup group. Any changes made will be saved.
 - Pressing **i** at any time within setup group will return the operator to the main screen. Any changes made will be saved.
 - Pressing **SETUP** at any time within the setup group will advance the operator to the next setup group. Any changes made will be saved.

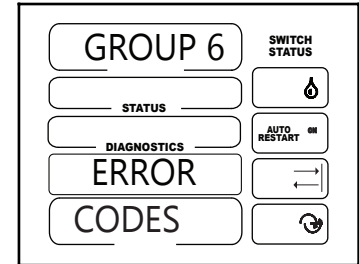

Figure 39-1

Viewing or Clearing An Error Code

To view an error code or clear an error code count, do the following:

1. GROUP 6 ERROR CODES should be displayed.
2. Press **SELECT** to advance to the desired error code. The most recent event date and time will be displayed.
 - View the error code or clear the error code count by pressing/holding **SELECT** until the count is cleared (approximately 3 seconds).

NOTE

- The date and time displayed is the most recent event of the error.
- The "#255" illustrated is the number of times the event occurred. The range is 0 - 255.

Error Codes

The error code names, descriptions and display screens are shown below and on the following pages. See the troubleshooting section of the Select2 Control Panel Owner's Manual PN 0997443 (English) for help with resolving problems.

E01 BATTERY BACKED RAM

Module self test of battery backed memory detected a data error indicating a possible failure of the BBRAM module which may require replacement. See figure 39-2.

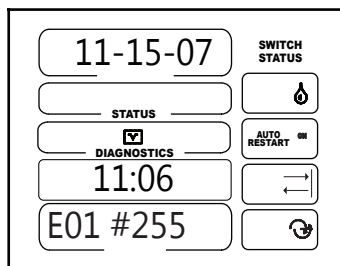

Figure 39-2

E03 UNIT RESETS

This error code records the number of power cycles and/or software resets. See figure 39-4.

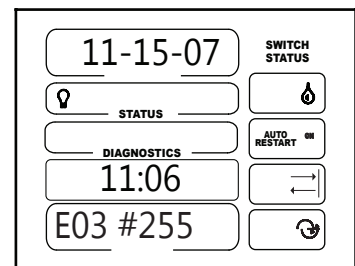

Figure 39-4

E02 EEPROM

Module self test of nonvolatile memory detected a data error. See figure 39-3.

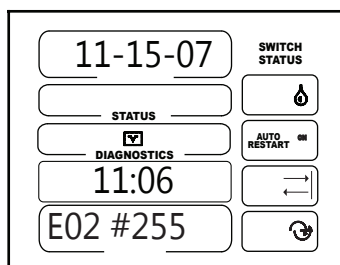

Figure 39-3

E04 POWER DROP

The machine voltage momentarily dropped below the low voltage setting. See figure 39-5.

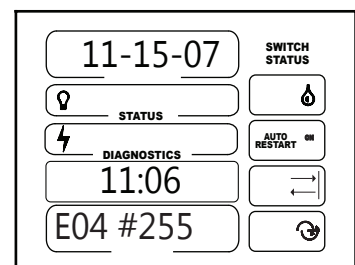

Figure 39-5

Valley Select2 Control Panel

Setup

Setup Group 6 - Error Codes

E05 SYSTEM SAFETY

The machine safety circuit was momentarily open. See Figure 40-1.

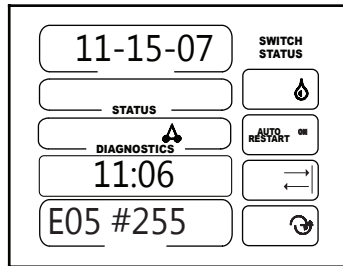

Figure 40-1

E10 PRESSURE SENSOR

The water pressure was above the low pressure setting after five minutes with pump off. See figure 40-6.

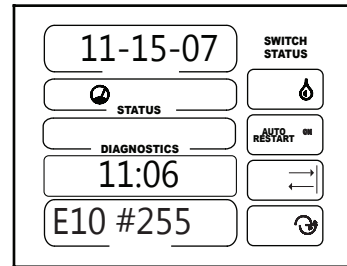

Figure 40-6

E06 PUMP SAFETY

The water pressure dropped below the low pressure limit during the operating pressure time delay. See figure 40-2.

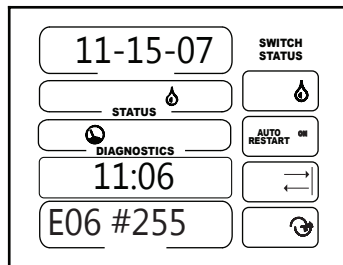

Figure 40-2

E11 RESOLVER POSITION ERRATIC

The pivot position jumped or moved 5° or more in one second. See figure 40-7.

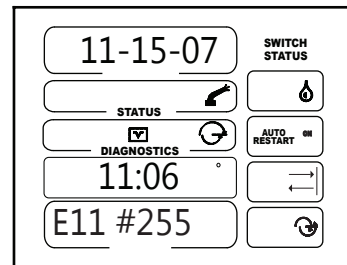

Figure 40-7

E07 PRESSURE SENSOR TOO HIGH

The water pressure sensor value too high. Above 160 psi (1103.1 kPa). See figure 40-3.

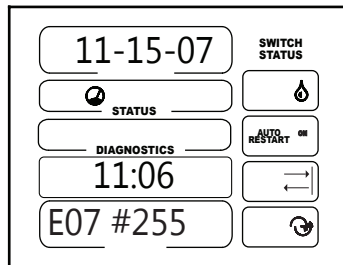

Figure 40-3

E12 RESOLVER OUT OF RANGE

The resolver return voltage value is too high. See figure 40-8.

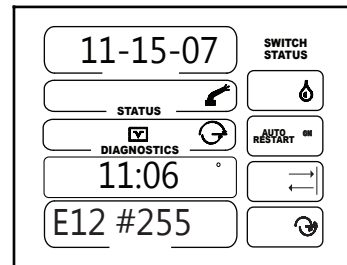

Figure 40-8

E08 PRESSURE SENSOR TOO LOW

The water pressure sensor value too low. Below 6 psi (41.3 kPa) or the pressure sensor is disconnected. See figure 40-4.

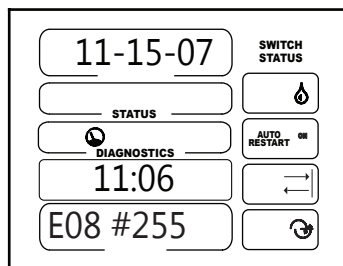

Figure 40-4

E13 KEYPAD

The keypad has failed or a key is stuck for 10 seconds. See figure 40-9.

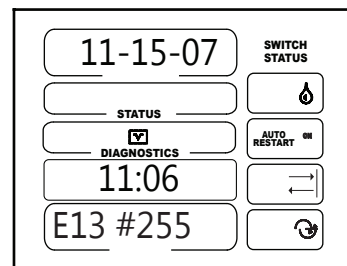

Figure 40-9

E09 PRESSURE SENSOR HIGH WITH PUMP off

The water pressure stayed above 7 psi (48.2 kPa) after pump had been off for five minutes. See figure 40-5.

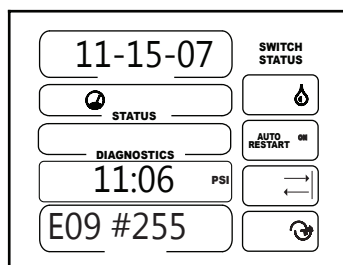

Figure 40-5

E14 FWD/REV SENSE

Both forward and reverse run lines were momentarily powered for more than two seconds. See figure 40-10.

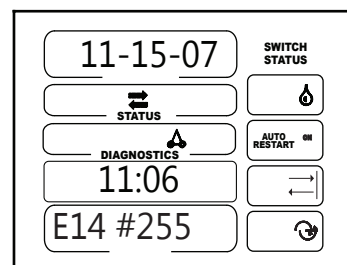

Figure 40-10

Setup Group 6 - Error Codes

E18 GPS COMMUNICATION ERROR

No GPS messages have been received for 20 seconds. This error code is recorded when the machine stops. See Figure 41-1.

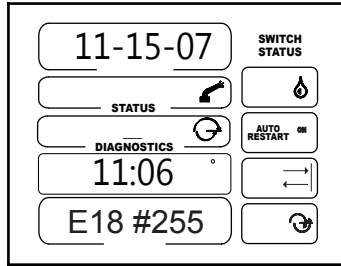

Figure 41-1

E23 PLC COMMUNICATIONS ERROR

PLC with GPS V2 did not replay to control panel messages 3 times in a row. See figure 54-4.

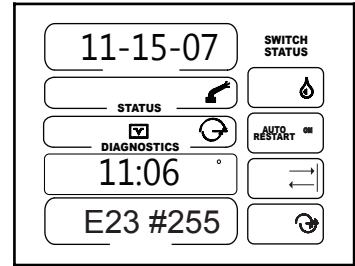

Figure 41-4

E19 GPS SIGNAL LOSS

The GPS receiver is not locked onto the GPS satellite signal. See figure 41-2.

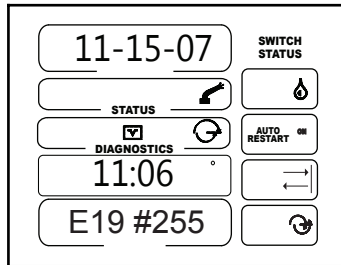

Figure 41-2

E25 GPS COORDINATES OUT OF RANGE

GPS distance outside of allowed length, pivot point coordinates incorrect. Crosstalk from another GPS device on the same channel. See figure 54-5.

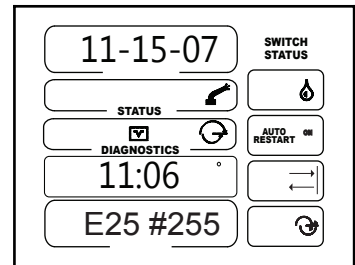

Figure 41-5

E20 DGPS SIGNAL LOSS

The quality of GPS signal has changed from DGPS to STANDARD GPS. See figure 41-3.

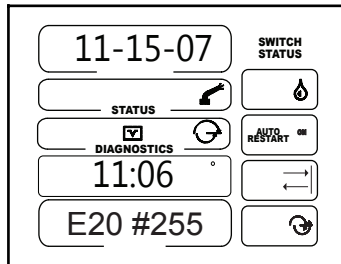

Figure 41-3

Valley Select2 Control Panel

Setup

Setup Group 7 - Time/Date

The following values can be viewed and set within setup group 7:

- Hours • Minutes • Month • Day • Year

1. From the main screen, press and hold **SETUP** until GROUP 7 is displayed or press **SETUP** seven times.
2. GROUP 7 will be shown in the display screen. See figure 43-1.
 - Pressing **SELECT** advances the operator to the next value in the setup group. Any changes made will be saved.
 - Pressing **i** at any time within setup group will return the operator to the main screen. Any changes made will be saved.
 - Pressing **SETUP** at any time within the setup group will advance the operator to the next setup group. Any changes made will be saved.

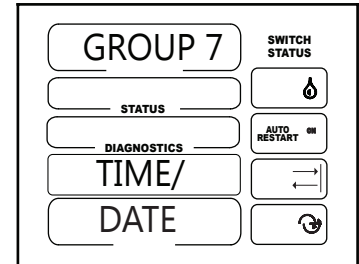

Figure 43-1

Setting Time and Date

If the entered value is not valid on any of the following display screens then that value will not be saved:

Hours

1. The HH (hours) should be flashing. See figures 43-2 and 58-3.
2. Press **+** or **-** to change the value.
3. Press **SELECT** to view the next value in the setup group.

Minutes

1. The MM (minutes) should be flashing. See figures 43-2 and 58-3.
2. Press **+** or **-** to change the value.
3. Press **SELECT** to view the next value in the setup group.

Month

1. The MM (month) should be flashing. See figures 43-2 and 58-3.
2. Press **+** or **-** to change the value.
3. Press **SELECT** to view the next value in the setup group.

Day

1. The DD (day) should be flashing. See figures 43-2 and 58-3.
2. Press **+** or **-** to change the value.
3. Press **SELECT** to view the next value in the setup group..

Year

1. The YY (year) should be flashing. See figures 43-2 and 58-3.
2. Press **+** or **-** to change the value.
3. Press **SELECT** to view the next value in the setup group.

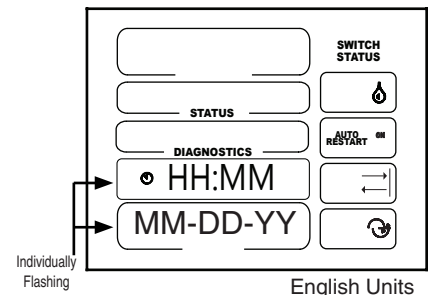

Figure 43-2

English Units

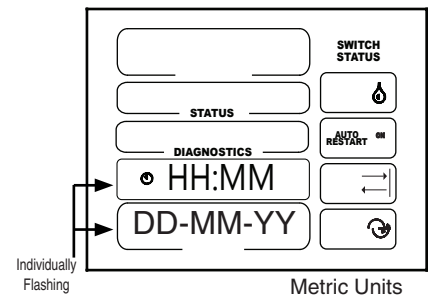

Figure 43-3

Metric Units

Valley Select2 Control Panel

Setup

Valley Select2 Control Panel

Setup

Setup Group 8 - GPS

The following values can be viewed and set within setup group 8 only when GPS is selected as a protocol:

- Current Latitude
- Current Longitude
- Satellite Count and Quality
- Pivot Point
- Pivot Point Latitude
- Pivot Point Longitude
- Fallback Position
- Pivot Length
- Pivot Speed
- GPS Distance
- GPS Distance Length -
- GPS Distance Length +
- Shutdown System Timer
- Disable End guns Timer
- GPS Loss Shutdown

Before the settings in setup group 8 can be viewed or adjusted, the 25-Pin com port in Setup Group 5 - Communications must be set to 4800 baud and the protocol must be set to GPS. If GPS positioning has not been enabled, GPS DISABLED will be displayed and access to the GPS values will not be available.

1. From the main screen, press and hold **SETUP** until GROUP 8 is displayed or press **SETUP** eight times.
2. GROUP 8 will be shown in the display screen. See figure 45-1.
 - Pressing **SELECT** advances the operator to the next value in the setup group. Any changes made will be saved.
 - Pressing **i** at any time within setup group will return the operator to the main screen. Any changes made will be saved.
 - Pressing **SETUP** at any time within the setup group will advance the operator to the next setup group. Any changes made will be saved.

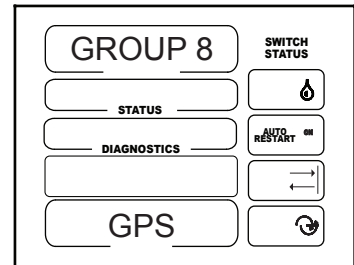

Figure 45-1

Current Latitude

The current latitude screen displays the current latitude. When the GPS signal is lost, NO GPS is displayed in place of the GPS coordinates.

1. CUR LAT: and GPS coordinates should be displayed. See figure 45-2.
2. Press **SELECT** to view the next value in the setup group.

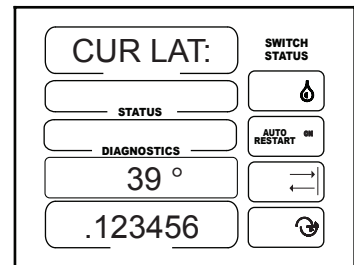

Figure 45-2

Current Longitude

The current longitude screen displays the current longitude. When the GPS signal is lost, NO GPS is displayed in place of the GPS coordinates.

1. CUR LON: and GPS coordinates should be displayed. See figure 45-3.
2. Press **SELECT** to view the next value in the setup group.

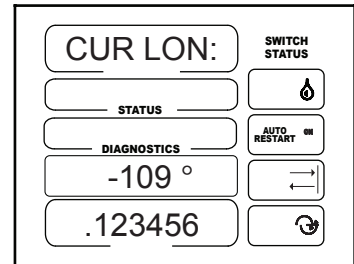

Figure 45-3

NOTE

- The backup position will be used if the GPS coordinates are not valid. The position on the main screen will blink to indicate that this has occurred.

Satellites

The satellites screen displays the number of satellites and the quality of the signal. Signal quality range is None, STANDARD and DGPS.

1. # SAT: , number of satellites and quality of the satellite signal should be displayed. See figure 45-4.
2. Press **SELECT** to view the next value in the setup group.

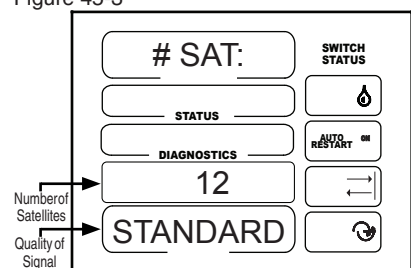

Figure 45-4

Valley Select2 Control Panel

Setup

Setup group 8 - GPS



Pivot Point

Pivot point is used to review and enter GPS pivot point coordinates. The value range is REVIEW, EDIT AND SET. The default value is REVIEW.

REVIEW - Display the current pivot point latitude and longitude values.



EDIT - Manually enter the known pivot point latitude and longitude values.

SET - Automatically enter the current received GPS position as the pivot point latitude and longitude values.

1. PIVOT POINT should be flashing. See figure 46-1.
2. Press  or  to set the mode to REVIEW, EDIT or SET.
3. Press  to view the next value in the selected mode.

Review

When REVIEW is selected the pivot point latitude and longitude values are displayed. Values cannot be changed in REVIEW.

1. PivP LAT should be flashing and the pivot point latitude value is displayed. Default latitude is 90°. See figure 46-2.
2. Press  to view the next value in the setup group.
3. PivP LON should be flashing and the pivot point longitude value is displayed. Default longitude is 180°. See figure 46-3.
4. Press  to view the next value in the setup group.

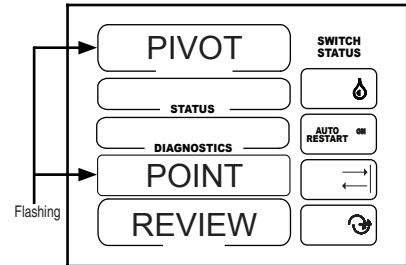

Figure 46-1

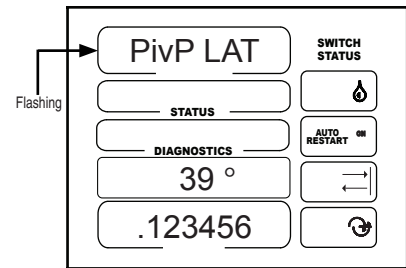

Figure 46-2

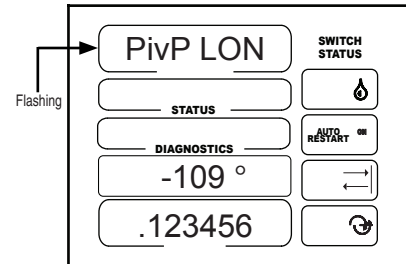

Figure 46-3

Setup group 8 - GPS

Pivot Point (continued)

Edit

When EDIT is selected the pivot point latitude and longitude values can be changed manually. Use a handheld GPS receiver to obtain the GPS pivot point latitude and longitude.

1. PivP LAT should be flashing. Default latitude is 90°. See figure 47-1.
2. Press **+** or **-** to enter the known pivot point latitude.
3. Press **SELECT** to view the next value in the setup group.
4. PivP LON should be flashing. Default longitude is 180°. See figure 47-2.
5. Press **+** or **-** to enter the known pivot point longitude.
6. Press **SELECT** to view the next value in the setup group.

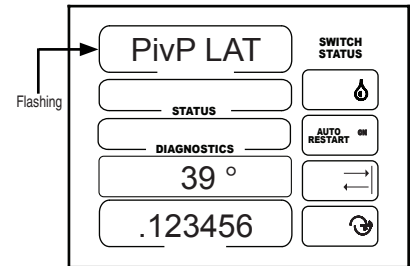

Figure 47-1

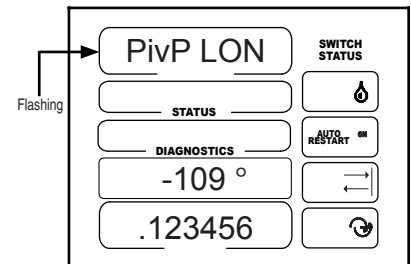

Figure 47-2

NOTE

- Latitude and longitude positions displayed on a handheld GPS receiver are commonly displayed as North, South, East or West.
- The direction displayed affects how the position is entered into the control panel.
- If the position is shown as West or South the position must be entered as a negative degree.
- In North America:
 - Latitude positions are always positive.
 - Longitude positions are always negative.
- Adjustment of any numeric value can be accelerated by continuously pressing **+** or **-**.
- After setup, if the pivot point position is shown incorrectly as 90° or 270°, make sure that the positive or negative value was entered correctly.

Valley Select2 Control Panel



Setup

Setup group 8 - GPS

Pivot Point (continued)

Set

When SET is selected the pivot point latitude and longitude values are changed automatically. A GPS receiver connected to the control panel and positioned on top of the collector ring cover must be used to automatically enter the pivot point latitude and longitude. If no GPS signal exists, NO GPS will be displayed and the pivot point latitude and longitude values will not be changed. Values cannot be manually changed when using SET.

1. PivP LAT should be flashing and the pivot point latitude value is displayed. Default latitude is 90°. See figure 48-1.
2. Press  to view the next value, pivot point longitude.
3. PivP LON should be flashing and the pivot point longitude value is displayed. Default longitude is 180°. See figure 48-2.
4. Press  to view the next value in the setup group.

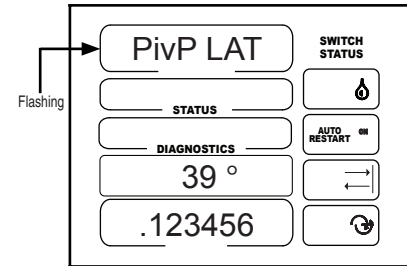

Figure 48-1

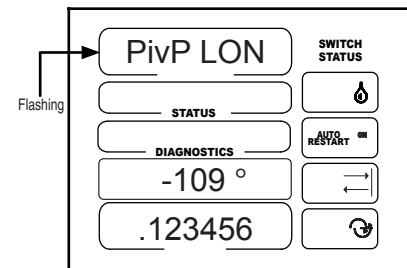

Figure 48-2

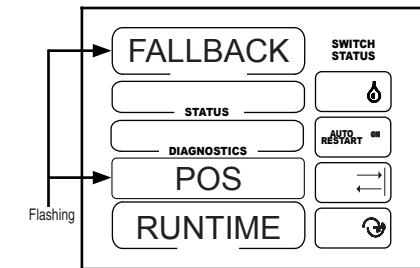

Figure 48-3

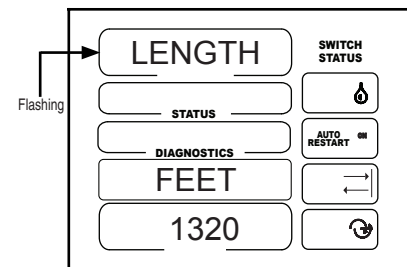

Figure 48-4



Fallback Position

Fallback position is the alternate type of positioning to be used if a loss of GPS signal occurs.

NONE - Disables fallback position



RUNTIME - When the runtime position type is enabled and if a loss of GPS signal occurs the position will be calculated based on runtime until the GPS position is re-acquired.

RESOLVER - When the resolver position type is enabled and if a loss of GPS signal occurs the position will be calculated based on resolver position until the GPS position is re-acquired. The machine must be equipped with a resolver to use the resolver position type.

1. FALLBACK POS should be flashing. See figure 48-3.
2. Press  or  to change the value.
3. Press  to view the next value in the setup group.

Machine Length

The machine length value is used by fallback position RUNTIME. Enter the length of the machine (the distance from the pivot point to the last regular drive unit not including the overhang) in feet or meters depending on the units setting. Default is 1320 feet.

1. LENGTH should be flashing. See figure 48-4.
2. Press  or  to change the value.
3. Press  to view the next value in the setup group.

Setup group 8 - GPS

Machine Speed

The machine speed value is used by fallback position RUNTIME. Enter the maximum speed of the machine in feet per minute or meters per minute depending on the units setting. Default value is 15.560.

1. SPEED should be flashing. See figure 49-1.
2. Press **+** or **-** to change the value.
3. Press **SELECT** to view the next value in the setup group.

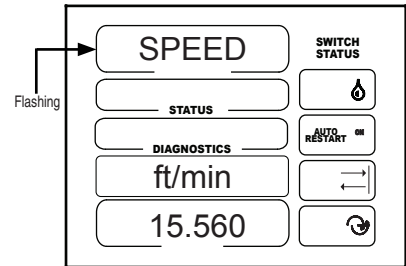

Figure 49-1

GPS Distance

The GPS distance value is the length to GPS. Enter the length to GPS in feet or meters depending on the units setting. The range is 10 to 6554 feet or 3.0 to 1997.6 meters. Default value is 1320 feet.

1. GPS DIST should be flashing. See figure 62-2.
2. Press **+** or **-** to change the value.
3. Press **SELECT** to view the next value in the setup group.

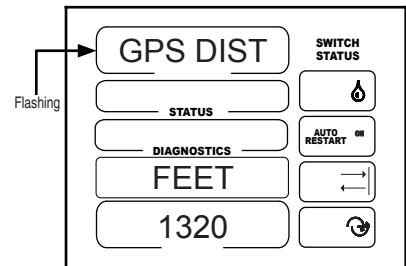

Figure 49-2

GPS Distance Length -

The GPS distance length - is the GPS distance length tolerance minus value. Enter the minus tolerance value in feet or meters depending on the units setting. The range is 10 to 6554 feet or 3.0 to 1997.6 meters. Default value is 50 feet.

1. LENGTH - should be flashing. See figure 62-3.
2. Press **+** or **-** to change the value.
3. Press **SELECT** to view the next value in the setup group.

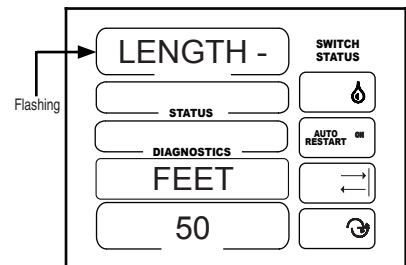

Figure 49-3

GPS Distance Length +

The GPS distance length + is the GPS distance length tolerance plus value. Enter the plus tolerance value in feet or meters depending on the units setting. The range is 10 to 6554 feet or 3.0 to 1997.6 meters. Default value is 50 feet.

1. LENGTH + should be flashing. See figure 62-4.
2. Press **+** or **-** to change the value.
3. Press **SELECT** to view the next value in the setup group.

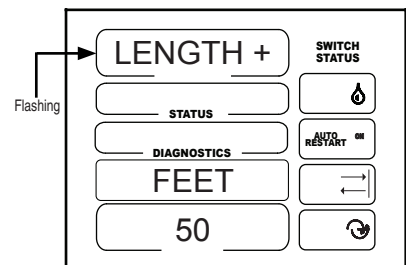

Figure 49-4

Valley Select2 Control Panel

Setup

Setup group 8 - GPS

Shutdown System Timer

The shutdown system timer works in conjunction with GPS loss shutdown. Enter the time delay in minutes or set to off.

When shutdown system timer and GPS loss shutdown are enabled and a loss of GPS signal or no communications to the GPS satellite occurs, the shutdown system timer delays the shutdown of the machine for the specified delay time. If the GPS signal is re-acquired before the delay time expires the machine will continue to run. Default is 20 minute delay.

OFF - Disables the shutdown system timer.

Delay Time - Setting a delay time enables the shutdown system timer.

1. NO GPS OFFdly should be flashing. See figure 50-1.
2. Press **+** or **-** to change the value.
3. Press **SELECT** to view the next value in the setup group.

Disable End guns Timer

The disable end gun timer works in conjunction with GPS loss shutdown. Enter the time delay in minutes or set to off.

When disable end guns timer and GPS loss shutdown are enabled and a loss of GPS signal or no communications to the GPS satellite occurs, the disable end guns timer delays the disabling of end gun and wide boundary outputs for the specified delay time. When the GPS signal is re-acquired the end gun and wide boundary outputs are enabled. Default is off.

OFF - Disables the disable end guns timer.

Delay Time - Setting a delay time enables the disable end guns timer.

1. NoGPS EG OFFdly should be flashing. See figure 50-2.
2. Press **+** or **-** to change the value.
3. Press **SELECT** to view the next value in the setup group.

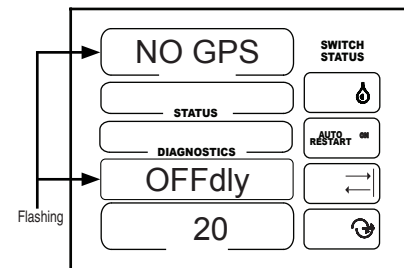

Figure 50-1

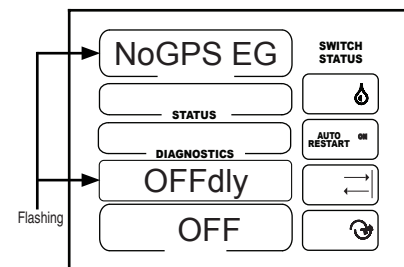

Figure 50-2

Setup group 8 - GPS

GPS Loss Shutdown

When GPS loss shutdown is enabled and a loss of GPS signal or no communications to the GPS satellite occurs for longer than the delay time programmed in the shutdown system timer, then the control panel will log the appropriate error code, system fault, and then shutdown the machine. Set the value to DGPS (Differential Global Positioning System) or STANDARD (Standard Global Positioning System). Default is standard.

If a delay time is set in shutdown system timer and the GPS signal is re-acquired before the delay time expires the machine will continue to run.

1. GPS LOSS SHTDWN should be flashing. See figure 51-1.
2. Press or to change the value.
3. Press to view the next value in the setup group.

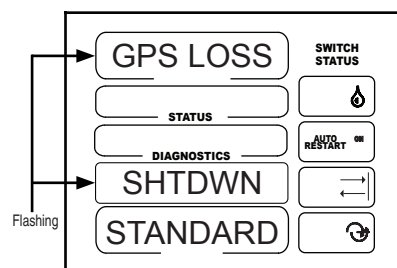

Figure 51-1

NOTE

- STANDARD enables GPS loss shutdown and shutdown system timer.
- DGPS enables DGPS loss shutdown and shutdown system timer.
- To shut off set the shutdown system timer (NO GPS OFFdly) to off.

Valley Select2 Control Panel

Setup

Valley Select2 Control Panel

Programming

Designing Programs

Each program is a defined sector in the field within each sector, the direction of travel, water on and depth of application or water off and percent timer values can be set up to nine programs can be written.

NOTE

- Blank program design forms are available in the appendix of this manual.
- All program examples on this and the following pages assume that the minimum control panel setup has been completed and that no programs currently exist.

Follow these steps when designing programs:

1. Make a sketch of the field on program design form to identify what the machine needs to do.
2. For each program/sector determine the following:
 - a) Left angle of sector (start of sector)
 - b) Direction of travel (forward, reverse or both)
 - c) Commands (water on and depth of application or water off and percent timer value)
 - d) Right angle of sector (end of sector)
3. Enter information into the program design form table to make entering the program(s) in the control panel easier. The example below illustrates how to use the program design form to outline a program. See figure 53-1

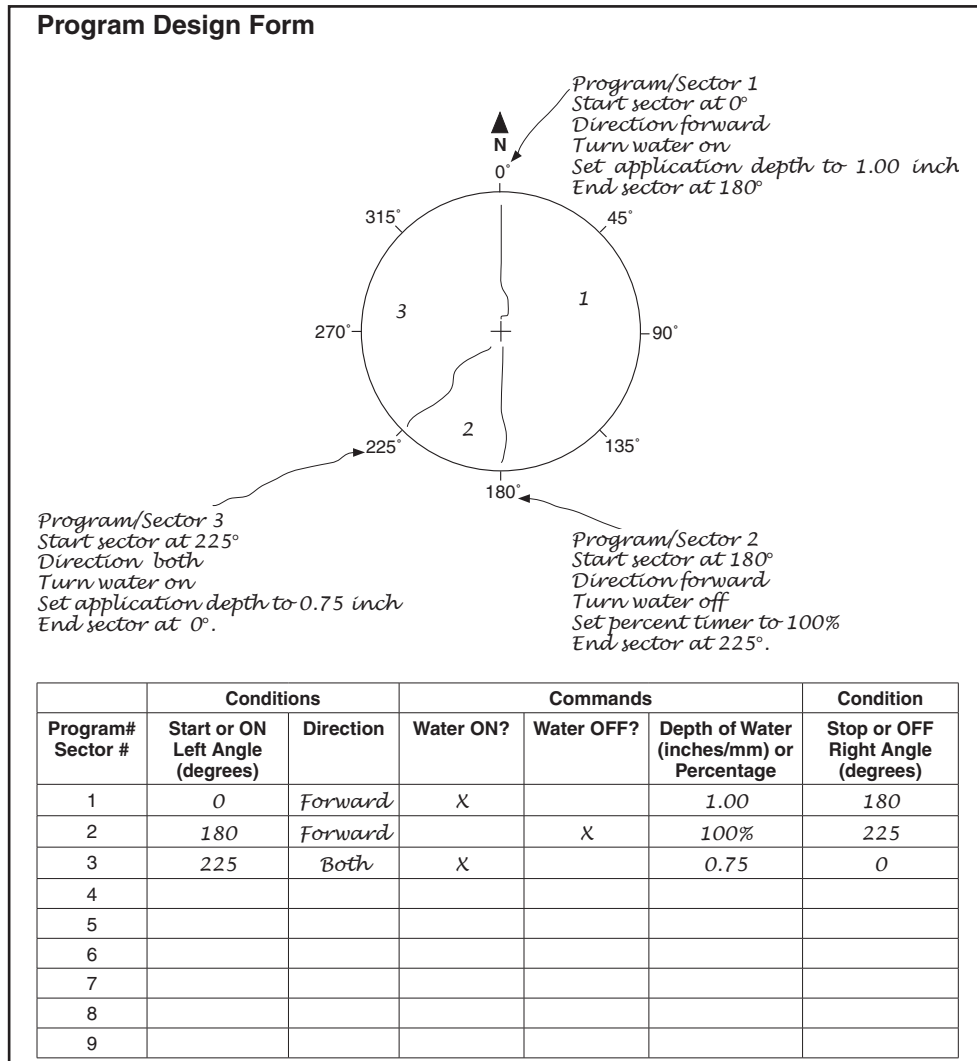

Figure 53-1

Valley Select2 Control Panel

Programming

Valley Select2 Control Panel

Programming

Program Example 1 (Full Circle, Two Sectors)

In this program example, the machine is being started at a specific position, water one half of the field, then leave water turned on, set depth, water the remaining half of the field at a new depth. Program will continue running until the STOP button is pressed. See figure 55-1.

Current machine condition:

- Machine is off at 0.0°.

Program Machine By:	Conditions	Commands
Program 1 Sector 1	0.0° - 180° Both Directions	Water on, Depth 1.00"
Program 2 Sector 2	180° - 0.0° Both Directions	Water on, Depth 0.75"

NOTE

- Press and hold  before programming any sector to clear the previously entered program.

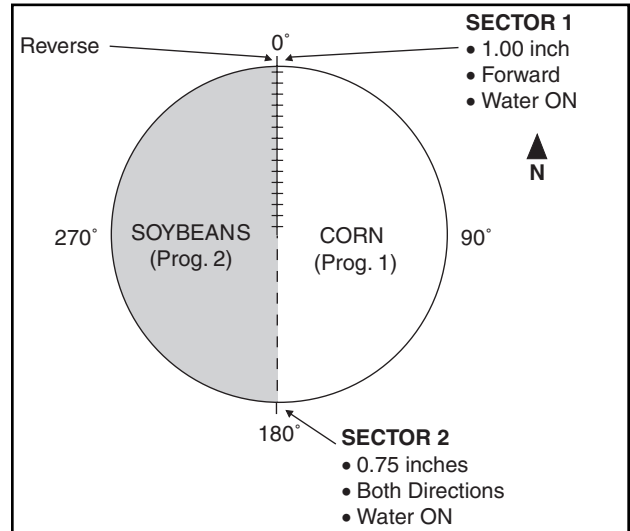















Figure 55-1

Start Programming

To program the example, follow these steps:

1. Start a new program, PROG 1.
 - a) From the main screen, press and hold  until GROUP 2 is displayed or press  two times.
 - b) Press  to access the sector programs.
 - c) If sector programs are off, press  to turn sector programs on.
 - d) Press  to view the next value.

PROGRAM 1 - Sector 1

2. Set left angle of sector and the direction of travel. See figure 55-2.
 - a) Press  or  to change the left angle value to 0.0°.
 - b) The default direction is both . This does not need to be changed.
 - c) Press  to view the next value.
3. Set water on and depth of water for the sector. See figure 55-3.
 - a) Press  to turn the water on. The water on icon  is displayed.
 - b) Press  or  to change the depth value to 1.00".
 - c) Press  to view the next value.

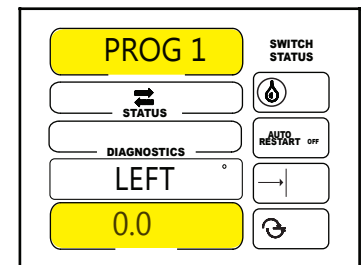

Figure 55-2

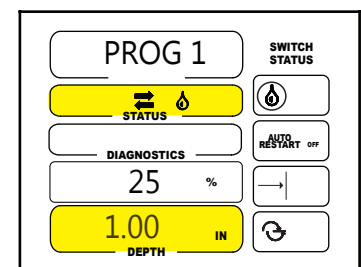

Figure 55-3

Valley Select2 Control Panel

Programming

Program Example 1

PROGRAM 1 - Sector 1 (continued)

4. Set the right angle of the sector. See figure 56-1.
 - a) Press **+** or **-** to change the right angle value to 180.0°.
 - b) Press **SELECT** to view the next value.

PROGRAM 2 - Sector 2

1. Start a new program, PROG 2.
2. Set left angle of sector and the direction. See figure 56-2.
 - a) Press **+** or **-** to change the left angle value to 180.0°.
 - b) The default direction is both **↔**. This does not need to be changed.
 - c) Press **SELECT** to view the next value.
3. Set water on and depth of water for the sector. See figure 56-3.
 - a) Press **💧** to turn the water on. The water on icon **💧** is displayed.
 - b) Press **+** or **-** to change the depth value to 0.75".
 - c) Press **SELECT** to view the next value.
4. Set the right angle of the sector. See figure 56-4.
 - a) Press **+** or **-** to change the right angle value to 0.0 °.
 - b) Press **SELECT** to view the next value.
5. Return to the main screen.
 - a) Press **i**.

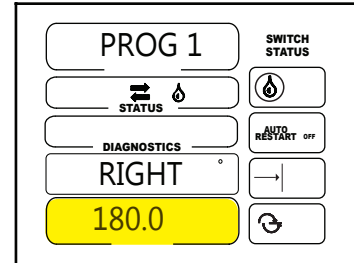

Figure 56-1

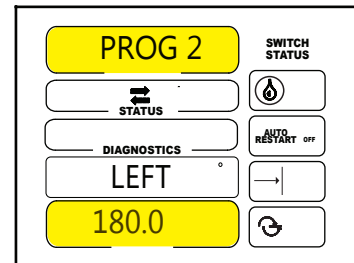

Figure 56-2

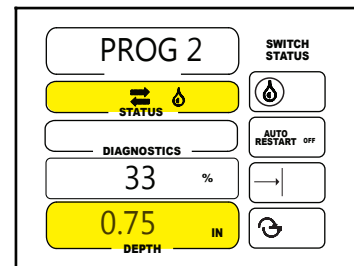

Figure 56-3

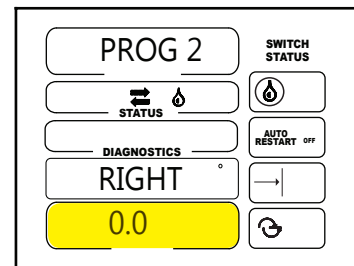

Figure 56-4

Valley Select2 Control Panel

Programming

Program Example 2 (Half Circle, Two Sectors)

In this program example, the machine is being programmed to start at a specific position, water one half of the field, then turn the water off, reverse at 90° at 100%. Program will continue running until the STOP button is pressed. See figure 57-1.

Current machine condition:

- Machine is off at 270°.

Program Machine By:	Conditions	Commands
Program 1 Sector 1	270° - 90° Forward	Water on Depth 1.00"
Program 2 Sector 2	90° - 270° Reverse	Water off 100%

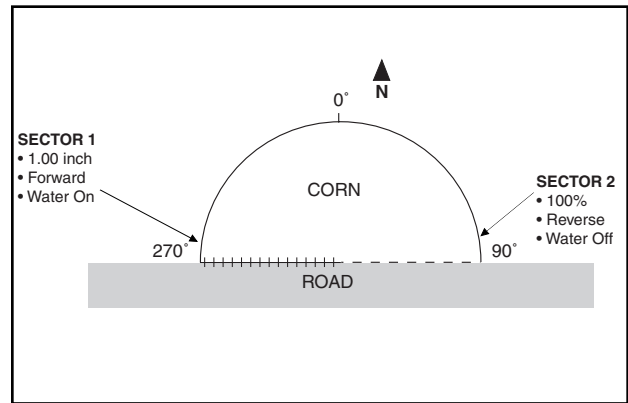

Figure 57-1

NOTE

- Press and hold before programming any sector to clear the previously entered program.

Start Programming

To program the example, follow these steps:

- Start a new program, PROG 1.
 - From the main screen, press and hold until GROUP 2 is displayed or press two times.
 - Press to access the sector programs.
 - If sector programs are off, press to turn sector programs on.
 - Press to view the next value.

PROGRAM 1 - Sector 1

- Set left angle of sector and the direction. See figure 57-2.
 - Press or to change the left angle value to 270.0°.
 - Press to activate start forward. The is displayed.
 - Press to view the next value.
- Set water on and depth of water for the sector. See figure 57-3.
 - Press to turn the water on. The water on icon is displayed.
 - Press or to change the depth value to 1.00".
 - Press to view the next value.

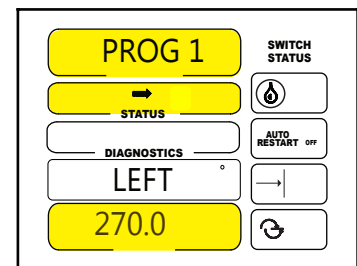

Figure 57-2

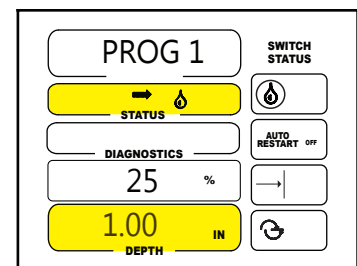

Figure 57-3

Valley Select2 Control Panel

Programming

Program Example 2

PROGRAM 1 - Sector 1 (continued)

4. Set the right angle of the sector. See figure 58-1.
 - a) Press **+** or **-** to change the right angle value to 90.0°.
 - b) Press **SELECT** to view the next value.

PROGRAM 2 - Sector 2

1. Start a new program, PROG 2.
2. Set the left angle of the sector. See figure 58-2.
 - a) Press **+** or **-** to change the left angle value to 270.0°.
 - b) Press **START REVERSE** to activate start reverse. The **←** icon is displayed.
 - c) Press **SELECT** to view the next value.
3. Set water off and percent timer for the sector. See figure 58-3.
 - a) Press **WATER OFF** to turn the water off.
 - b) Press **+** or **-** to change the percent timer value to 100%.
 - c) Press **SELECT** to view the next value.
4. Set the right angle of the sector. See figure 58-4.
 - a) Press **+** or **-** to change the right angle value to 90.0°.
 - b) Press **SELECT** to view the next value.
5. Return to the main screen.
 - a) Press **i**.

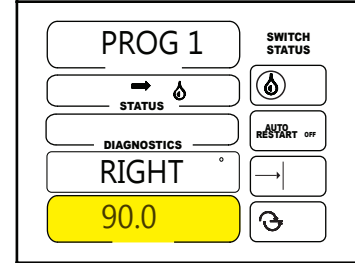

Figure 58-1

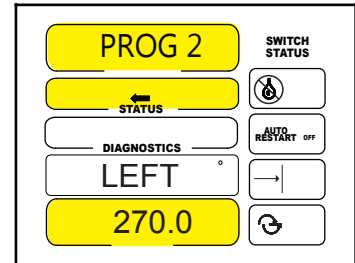

Figure 58-2

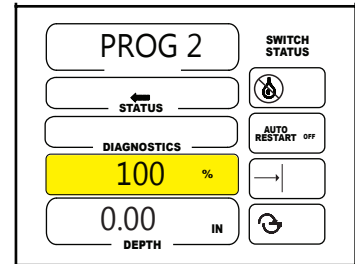

Figure 58-3

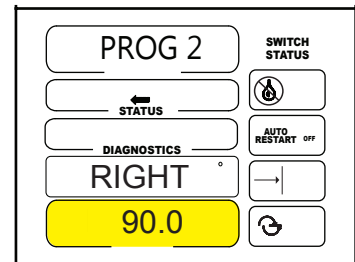

Figure 58-4

Valley Select2 Control Panel

Programming

Program Example 3 (Half Circle, Five Sectors)

In this program example, the machine is being programmed to start at a specific position and requires five sector programs. Sector 1 will be programmed to run reverse at 0.75", Sector 2 will be forward at 0.25", Sector 3 will be 0.50" in both directions, Sector 4 will be forward at 0.75", and Sector 5 will be reverse at 0.25". The program will continue running unless water off or % depth is changed. Starting and stopping the machine will allow the program to remain active. See figure 59-1.

Current machine conditions:

- Machine is off at 295°.

Program Machine By:	Conditions	Commands
Program 1 Sector 1	270° - 295° Reverse	Water on Depth 0.75"
Program 2 Sector 2	270° - 295° Forward	Water on Depth 0.25"
Program 3 Sector 3	295° - 70° Both Directions	Water on Depth 0.50"
Program 4 Sector 4	70° - 90° Forward	Water on Depth 0.75"
Program 5 Sector 5	70° - 90° Reverse	Water on Depth 0.25"

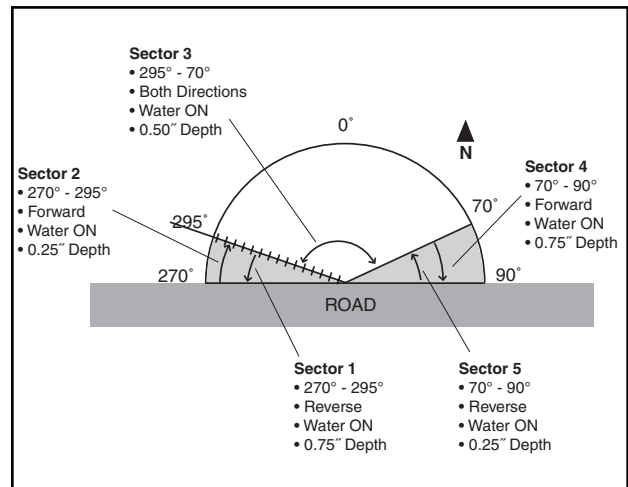







Figure 59-1

NOTE





- Press and hold  before programming any sector to clear the previously entered program.

Start Programming

To program the example, follow these steps:

1. Start a new program, PROG 1.
 - a) From the main screen, press and hold  until GROUP 2 is displayed or press  two times.
 - b) Press  to access the sector programs.
 - c) If sector programs are off, press  to turn sector programs on.
 - d) Press  to view the next value.

PROGRAM 1 - Sector 1

2. Set left angle of sector and the direction. See figure 59-2.
 - a) Press  or  to change the value to 270.0°.
 - b) Press  to activate start reverse. The  icon is displayed.
 - c) Press  to view the next value.

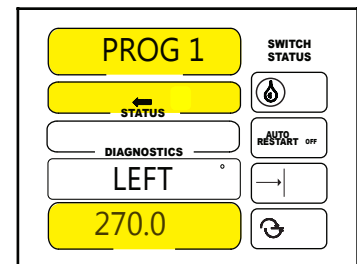









Figure 59-2

Valley Select2 Control Panel

Programming

Program Example 3

PROGRAM 1 - Sector 1 (continued)

3. Set water on and depth of water for the sector. See figure 60-1.
 - a) Press  to turn the water on. The water on icon  is displayed.
 - b) Press  or  to change the depth value to 0.75".
 - c) Press  to view the next value.
4. Set the right angle of the sector. See figure 60-2.
 - a) Press  or  to change the right angle value to 295.0°.
 - b) Press  to view the next value.

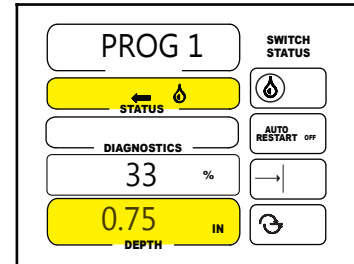

Figure 60-1

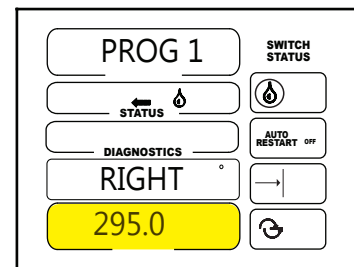















Figure 60-2

PROGRAM 2 - Sector 2

1. Start a new program, PROG 2.
2. Set left angle of sector and the direction. See figure 60-3.
 - a) Press  or  to change the left angle value to 270.0°.
 - b) Press  to activate start forward. The  icon is displayed.
 - c) Press  to view the next value.
3. Set water on and depth of water for the sector. See figure 60-4.
 - a) Press  to turn the water on. The water on icon  is displayed.
 - b) Press  or  to change the depth value to 0.25".
 - c) Press  to view the next value.
4. Set the right angle of the sector. See figure 60-5.
 - a) Press  or  to change the right angle value to 295.0°.
 - b) Press  to view the next value.

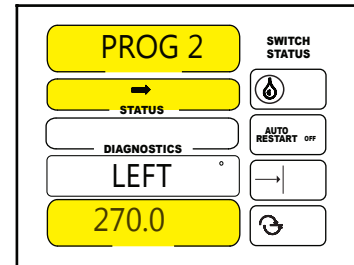

Figure 60-3

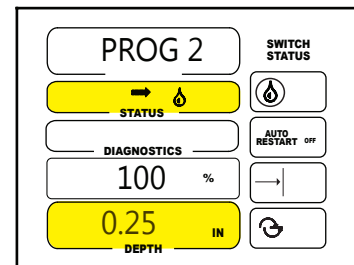

Figure 60-4

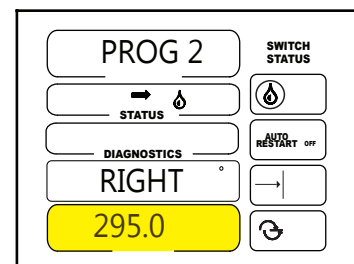

Figure 60-5

Valley Select2 Control Panel

Programming

Program Example 3

PROGRAM 3 - Sector 3

1. Start a new program, PROG 3.
2. Set left angle of sector and the direction. See figure 61-1.
 - a) Press **+** or **-** to change the value to 295.0°.
 - b) The default direction is both **↔**. This does not need to be changed.
 - c) Press **SELECT** to view the next value.
3. Set water on and depth of water for the sector. See figure 61-2.
 - a) Press **💧** to turn the water on. The water on icon **💧** will be displayed.
 - b) Press **+** or **-** to change the value to 0.50".
 - c) Press **SELECT** to view the next value.
4. Set the right angle of the sector. See figure 61-3.
 - a) Press **+** or **-** to change the value to 70.0°.
 - b) Press **SELECT** to view the next value.

PROGRAM 4 - Sector 4

1. Start a new program, PROG 4.
2. Set left angle of sector and the direction. See figure 61-4.
 - a) Press **+** or **-** to change the value to 70.0°.
 - b) Press **START FORWARD** to activate the **➡** icon in the status display.
 - c) Press **SELECT** to view the next value.
3. Set water on and depth of water for the sector.
 - a) Press **💧** to turn the water on. The water on icon **💧** will be displayed.
 - b) Press **+** or **-** to change the value to 0.75". See figure 61-5.
 - c) Press **SELECT** to view the next value.

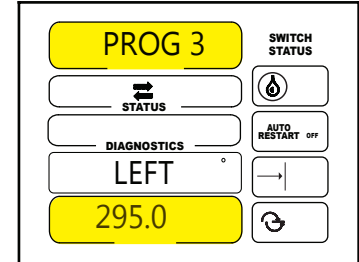

Figure 61-1

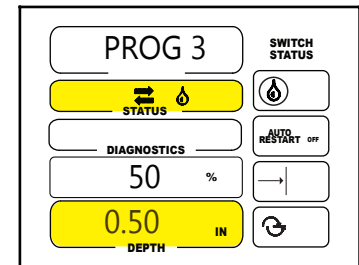

Figure 61-2

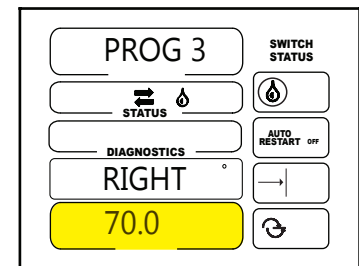

Figure 61-3

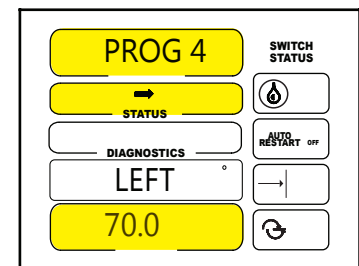

Figure 61-4

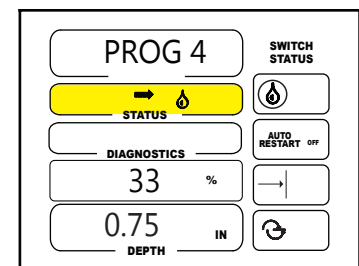





Figure 61-5

Valley Select2 Control Panel















Programming

Program Example 3

PROGRAM 4 - Sector 4 (continued)

4. Set the right angle of the sector. See figure 62-1.
 - a) Press  or  to change the value to 90.0°.
 - b) Press  to view the next value.

PROGRAM 5 - Sector 5

1. Start a new, PROG 5.
2. Set left angle of sector and the direction. See figure 62-2.
 - a) Press  or  to change the value to 70.0°.
 - b) Press  to activate the  icon in the status display.
 - c) Press  to view the next value.
3. Set water on and depth of water for the sector. See figure 62-3.
 - a) Press  to turn the water on. The water on icon  will be displayed.
 - b) Press  or  to change the depth value to 0.25".
 - c) Press  to view the next value.
4. Set the right angle of the sector. See figure 62-4.
 - a) Press  or  to change the right angle value to 90.0°.
 - b) Press  to view the next value.
5. Return to the main screen.
 - a) Press .

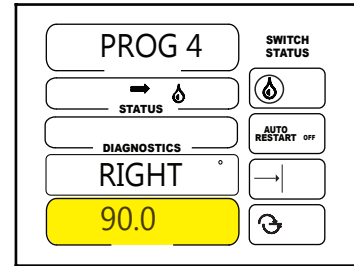

Figure 62-1

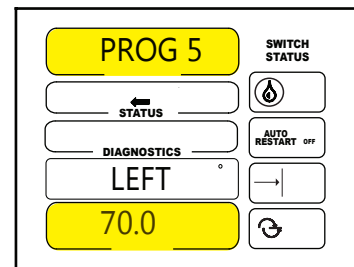

Figure 62-2

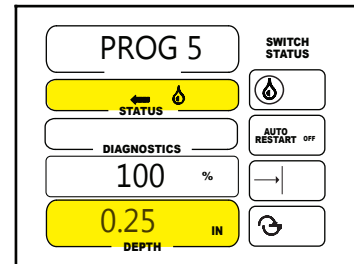

Figure 62-3

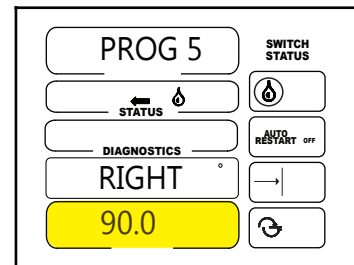

Figure 62-4

Valley Select2 Control Panel

Appendix

Setup Record

SETUP GROUP 1 - OPTIONS

Stop-In-Slot _____ degrees
Forward Position Left Angle _____ degrees
Reverse Position Right Angle _____ degrees
VRI-S States Off, 1, 2, 3, 4, 5 _____

END GUN SETTINGS

	ON (left angle)	OFF (right angle)
ENDG-1	_____	_____
ENDG-2	_____	_____
ENDG-3	_____	_____
ENDG-4	_____	_____
ENDG-5	_____	_____
ENDG-6	_____	_____
ENDG-7	_____	_____
ENDG-8	_____	_____
ENDG-9	_____	_____

WIDE BOUNDARY SETTINGS

	ON (left angle)	OFF (right angle)
WDBD-1	_____	_____
WDBD-2	_____	_____
WDBD-3	_____	_____
WDBD-4	_____	_____
WDBD-5	_____	_____
WDBD-6	_____	_____
WDBD-7	_____	_____
WDBD-8	_____	_____
WDBD-9	_____	_____

SETUP GROUP 3 - TIMERS

Startup Pressure Delay	_____ seconds	Auto Reverse/Stop Delay	_____ seconds
Operating Pressure Delay	_____ seconds	Percent Timer Cycle	_____ seconds
Power / Pressure Restart Delay	_____ seconds		

SETUP GROUP 4 - CONSTANTS

Minimum Application	_____ inches (mm)	Direction Offset	_____ degrees
Low Hours/Revolution	_____ hours	Engine/Pump Control	_____ pump/engine/alt engine
Low Pressure	_____ psi (KPa)	Auto Restart	_____ both/pressure/power
Voltage Calibration	_____ volts	Flow Meter	_____ off or on
Low Voltage Setting	_____ volts	Gallons or Liters Per Pulse	_____
Auto Reverse/Stop	_____ off or on	Units	_____ inches (mm)
Current Position	_____ degrees	Language	_____

SETUP GROUP 5 - COMMUNICATIONS

Baud 9-Pin	_____	Protocol 25-Pin	_____
Protocol 9-Pin	_____	RTU ID	_____
Baud 25-Pin	_____		

SETUP GROUP 8 - GPS

Current Latitude	_____	Pivot Speed	_____
Current Longitude	_____	GPS Distance	_____
Satellite Count and Quality	_____	GPS Distance Length -	_____
Pivot Point Review, Set, Edit	_____	GPS Distance Length +	_____
Pivot Point Latitude	_____	Shutdown System Timer	_____
Pivot Point Longitude	_____	Disable End guns Timer	_____
Fallback Position	_____	GPS Loss Shutdown	_____
Pivot Length	_____		

Valley Select2 Control Panel

Appendix

Setup Record

SETUP GROUP 1 - OPTIONS

Stop-In-Slot _____ degrees
 Forward Position Left Angle _____ degrees
 Reverse Position Right Angle _____ degrees
 VRI-S States Off, 1, 2, 3, 4, 5 _____

END GUN SETTINGS

	ON	OFF
	(left angle)	(right angle)

ENDG-1	_____	_____
ENDG-2	_____	_____
ENDG-3	_____	_____
ENDG-4	_____	_____
ENDG-5	_____	_____
ENDG-6	_____	_____
ENDG-7	_____	_____
ENDG-8	_____	_____
ENDG-9	_____	_____

WIDE BOUNDARY SETTINGS

	ON	OFF
	(left angle)	(right angle)

WDBD-1	_____	_____
WDBD-2	_____	_____
WDBD-3	_____	_____
WDBD-4	_____	_____
WDBD-5	_____	_____
WDBD-6	_____	_____
WDBD-7	_____	_____
WDBD-8	_____	_____
WDBD-9	_____	_____

SETUP GROUP 3 - TIMERS

Startup Pressure Delay _____ seconds	Auto Reverse/Stop Delay _____ seconds
Operating Pressure Delay _____ seconds	Percent Timer Cycle _____ seconds
Power / Pressure Restart Delay _____ seconds	

SETUP GROUP 4 - CONSTANTS

Minimum Application _____ inches (mm)	Direction Offset _____ degrees
Low Hours/Revolution _____ hours	Engine/Pump Control _____ pump/engine/alt engine
Low Pressure _____ psi (KPa)	Auto Restart _____ both/pressure/power
Voltage Calibration _____ volts	Flow Meter _____ off or on
Low Voltage Setting _____ volts	Gallons or Liters Per Pulse _____
Auto Reverse/Stop _____ off or on	Units _____ inches (mm)
Current Position _____ degrees	Language _____

SETUP GROUP 5 - COMMUNICATIONS

Baud 9-Pin _____	Protocol 25-Pin _____
Protocol 9-Pin _____	RTU ID _____
Baud 25-Pin _____	

SETUP GROUP 8 - GPS

Current Latitude _____	Pivot Speed _____
Current Longitude _____	GPS Distance _____
Satellite Count and Quality _____	GPS Distance Length - _____
Pivot Point Review, Set, Edit _____	GPS Distance Length + _____
Pivot Point Latitude _____	Shutdown System Timer _____
Pivot Point Longitude _____	Disable End guns Timer _____
Fallback Position _____	GPS Loss Shutdown _____
Pivot Length _____	

Valley Select2 Control Panel

Appendix

Program Design Form

Each program is a defined sector in the field. Up to nine programs can be written.

1. Make a sketch of the field to identify what the machine needs to do.
2. For each program/sector determine the following:
 - a) Left Angle of sector (Start of sector)
 - b) Direction of travel (Forward, Reverse or Both)
 - c) Commands
(Water On and Depth of Application or Water Off and Percent Timer value)
 - d) Right Angle of sector (End of sector)

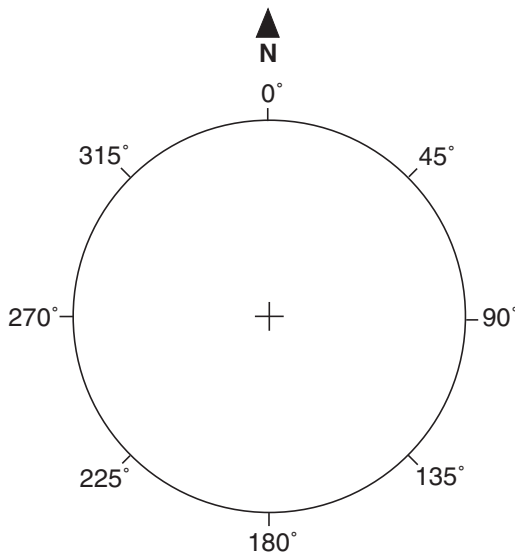
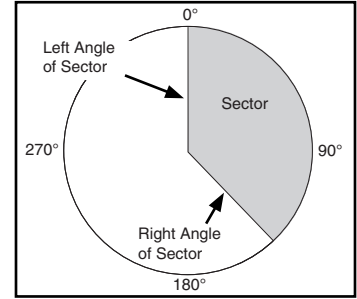

Program # Sector #	Conditions		Commands			Condition
	Start or ON Left Angle (degrees)	Direction	Water ON?	Water OFF?	Depth of Water (inches/mm) or Percentage	Stop or OFF Right Angle (degrees)
1						
2						
3						
4						
5						
6						
7						
8						
9						

Valley Select2 Control Panel

Appendix

Program Design Form

Each program is a defined sector in the field. Up to nine programs can be written.

1. Make a sketch of the field to identify what the machine needs to do.
2. For each program/sector determine the following:
 - a) Left Angle of sector (Start of sector)
 - b) Direction of travel (Forward, Reverse or Both)
 - c) Commands
(Water On and Depth of Application or Water Off and Percent Timer value)
 - d) Right Angle of sector (End of sector)

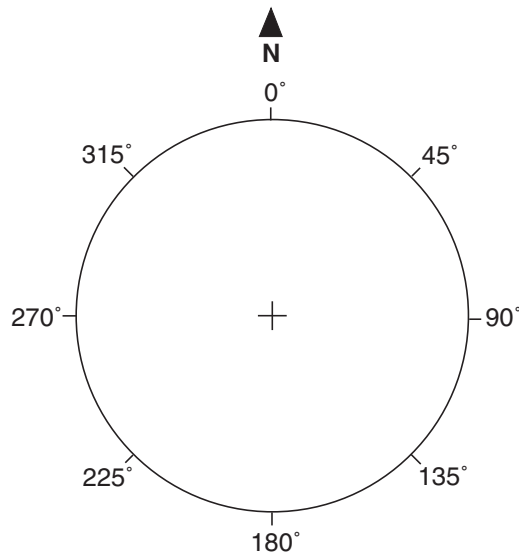
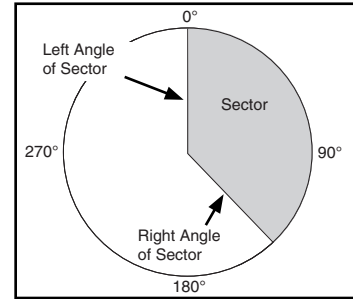

Program # Sector #	Conditions		Commands			Condition
	Start or ON Left Angle (degrees)	Direction	Water ON?	Water OFF?	Depth of Water (inches/mm) or Percentage	Stop or OFF Right Angle (degrees)
1						
2						
3						
4						
5						
6						
7						
8						
9						